

COMPETENCE B4100-1

The Versatile Built-In Oven

User Instructions



Dear customer

Please read these operating instructions carefully.

Pay particular attention to the section "Safety Instructions" on the first few pages. Please retain these operating instructions for later reference. Pass them on to possible new owners of the appliance.

The following symbols are used in the text:



Safety Instructions

Warning: Information concerning your personal safety.

Important: Information on how to avoid damaging the appliance.



Information and practical tips



Environmental information

1. These numbers indicate step by step how to use the appliance.
2. ...
3. ...

Before calling out an engineer to a fault please read the chapter "What to do if ..." as you may be able to resolve the problem yourself.

For further assistance contact your local AEG Service Force Centre, see the Chapter "Service and Spare Parts".

Your local AEG SERVICE FORCE centre is available at all times to deal with technical problems (addresses and telephone numbers are listed under "Customer Service Centres").

For additional information, also see the section "Service".

Printed on environmentally friendly paper.
Thinking ecologically means acting ecologically ...

CONTENTS

Operating Instructions	5
Safety	5
Disposal	6
Description of the Appliance	7
General Overview	7
Control Panel	7
Oven Features	8
Oven Accessories	9
Before Using for the First Time	10
Setting the Time	10
Initial Cleaning	11
Operating the Oven	12
Switching the Oven On and Off	12
Oven Functions	13
Inserting the Shelf and Universal Baking Tray	15
Attaching/Removing the Grill Pan Handle	16
Working with the Electronic Clock	17
Switching Off the Time Display	18
Usage, Tables and Tips	24
Baking	24
Baking Tables	26
Table: Desserts	30
Roasting	31
Table: Meat, roasting, casseroles	33
Table: Roasting, casseroles, au gratin	35
Grilling	37
Grilling Table	38
Defrosting	39
Defrosting Table	39
Preserving	40

Cleaning and Care	42
Exterior of the Appliance	42
Oven Interior	42
Accessories	42
Shelf Support Rails	43
Oven Lighting	44
Oven Door	45
Oven Door Glass	46
What to do if	48
Technical Data	49
Oven Interior Dimensions	49
Regulations, Standards, Directives	49
Installation Instructions	50
Safety Instructions for the Installer	50
Warranty conditions	56
Customer Service Centres	57
Index	58
Service and Spare parts	59

Operating Instructions



Safety

Electrical Safety

- The appliance may only be connected by a **registered specialist**.
- In the event of any faults or damage to the appliance: remove fuses or switch off.
- It is **not permissible** to clean the appliance with a steam or high pressure cleaner for safety reasons!
- **Repairs** to the appliance may **only be carried out by specialists**. Repairs carried out by inexperienced persons may cause injury or serious malfunctioning. If your appliance needs repairing, please contact your local AEG Service Force Centre or your specialist dealer.

Child Safety

- Never leave children unsupervised when the appliance is in use.

Safety whilst Using

- This appliance is intended to be used for cooking, frying and baking food in the home.
- Take care when connecting electric appliances to sockets nearby. Do **not** allow connecting leads to come into contact with hot rings or to catch beneath the hot oven door.
- **Warning: Risk of burns!** The interior of the oven becomes hot during use.
- Using ingredients containing alcohol in the oven may create an alcohol-air mixture that is easily ignited. In this case, open the door carefully. Do not have embers, sparks or naked flames in the vicinity when opening the door.

To Avoid Damaging Your Appliance

- Do not line your oven with aluminium foil and do not place a baking tray or dish on the oven floor, otherwise the oven enamel will be damaged by the resulting build up of heat.
- Juice from fruit that drips from baking trays will leave marks that cannot be removed. For very moist cakes, use the universal baking tray.
- Do not put any weight on the oven door when it is open.
- Never pour water directly into the hot oven. The enamel may be damaged.
- Using force, especially on the edges of the front glass panel, may break the glass.
- Do not store inflammable objects in the oven. They may ignite when the oven is switched on.
- Do not store moist food in the oven. The enamel may be damaged.



Disposal

Disposing of the packaging material

All materials used can be fully recycled.

Plastics are marked as follows:

- >PE< for polyethylene, as used for the outer wrapping and the bags inside.
- >PS< for polystyrene foam, e.g., as used for the padding materials. They are completely free of CFCs.

Disposal of old appliances



Warning: Before disposing of old appliances please make them inoperable so that they cannot be the source of danger.

To do this, disconnect the appliance from the mains supply and remove the mains lead.

To protect the environment, it is important that worn out appliances are disposed of in the correct manner.

- The appliance must not be disposed of with household rubbish.
- You can obtain information about collection dates or public refuse disposal sites from your local refuse department or council.

Description of the Appliance

General Overview

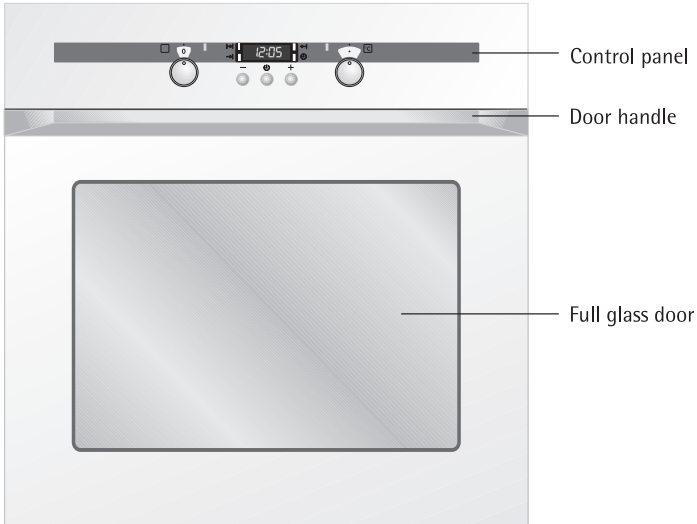

Control Panel

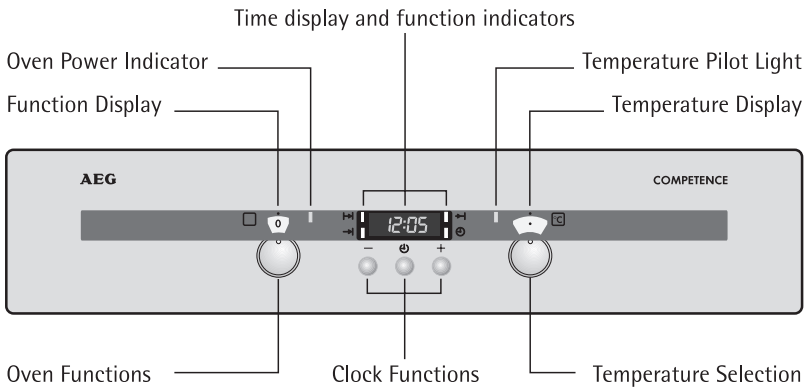

Oven Features

All of the interior walls of the oven are coated in a special enamel (catalytic coating).

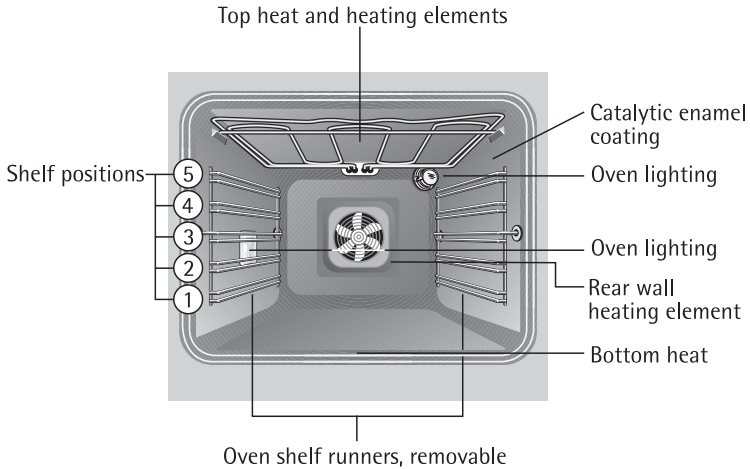

Relates only to appliances with a metal front:

Steam from the oven is fed out between the upper door edge and the control panel.

Fan run-on

The fan switches on automatically as soon as the oven is switched on. Once the oven has been switched off, the fan continues running to cool down the appliance and then switches itself off automatically.

Oven Accessories

Combination shelf

For dishes, cake tins, items for roasting and grilling.

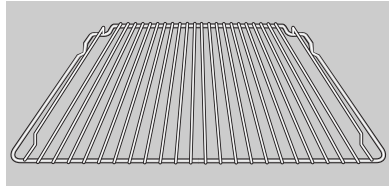

Universal baking tray

For moist cakes, juicy roasts or as a baking sheet or collecting vessel for fat.

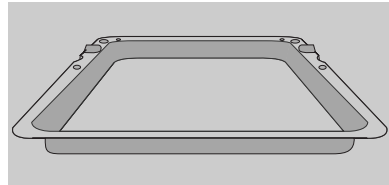

Grill pan with handle

Support for the grill tray as a collecting vessel for fat.

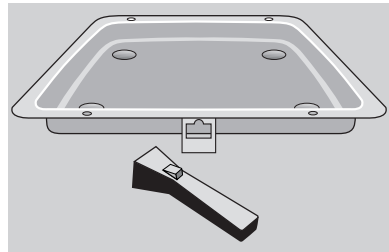

Grill tray

Insert for the grill pan for grilling smaller amounts of grilled food.

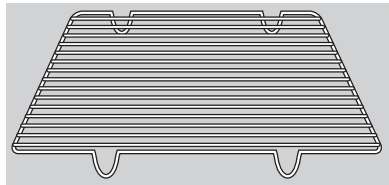

Before Using for the First Time

Setting the Time

i The oven will only operate when the time has been set.

1. The time function indicator  will flash after the appliance has been connected to the mains or following a power failure.



2. Using buttons  or  set the current time.

Wait for approx. 5 seconds.

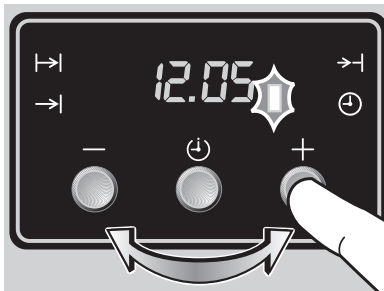

The flashing will stop and the clock will show the set time.



The appliance is ready for use.

Initial Cleaning

You should clean the oven before using it for the first time.



Caution: Do not use any caustic, abrasive cleaners! The surface could be damaged.



To clean the external parts of the oven, only use a cloth well wrung out with warm water to which a little washing up liquid has been added or a commercially available cleaner specifically designed for this purpose.

To prevent damaging the door or door glass, avoid the use of the following:

- Household detergent and bleaches
- Impregnated pads unsuitable for non-stick saucepans
- Brillo/Ajax pads or steel wool pads
- Chemical oven pads or aerosols
- Rust removers
- Bath/Sink stain removers

1. Turn the oven function switch to oven lighting .
2. Remove all accessories and the shelf support rails and wash them with warm water and washing up liquid.
3. Wash out the oven interior **with warm water only** and then dry.
4. Wipe the front of the appliance with a damp cloth.

Operating the Oven

Switching the Oven On and Off

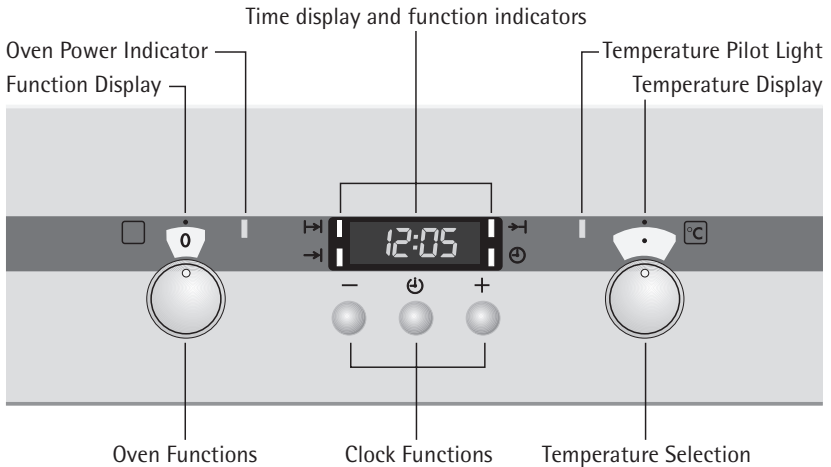

1. Turn the "oven functions" switch to the required function.
2. Turn the "temperature selection" switch to the required temperature.
The yellow oven power indicator is illuminated while the oven is in use.
The red temperature pilot light comes on while the oven is heating up.
3. To switch off the oven turn the "oven functions" switch and the "temperature selection" switch to the off position.



Cooling fan

The fan comes on automatically when the oven is in use in order to keep the surfaces of the appliance cool. Once the oven has been switched off, the fan continues running to cool down the appliance and then switches itself off automatically.

Oven Functions

The oven has the following functions:

Oven lighting

With this function you can **illuminate** the oven interior e.g. for cleaning.

The heating element is not in use.

Baking

For baking cakes on **one level** and for pastries that need more browning and a crispy base. These include such foods as pizza, quiche lorraine and cheese cake.

Set oven temperatures 20–40 °C lower than when using the conventional function.

Conventional is used and in addition the fan is switched on.

Fan cooking

For **baking on up to three levels** at the same time.

Set oven temperatures 20–40 °C lower than when using the conventional function.

The rear wall heating element is used and in addition the fan is switched on.

Conventional

For **baking and roasting on one level**.

The conventional heating elements are in use.

Bottom heat

For **crisping and browning** cakes with **crispy bases**.

The bottom heating element is in use.

Defrost

To **begin to thaw and to defrost** such items as flan, butter, bread, fruit or other **frozen foods**.

For this function the fan operates **without** heating.

 **Grill**

For **grilling** flat foods placed on the **middle of the shelf** such as steaks, escalopes or fish, or for **toasting**.

The grill heating element is in use.

 **Dual grill**

For **grilling larger quantities** of flat foods such as steaks, escalopes or fish, or for **toasting**.

Top heat and the grill heating element are in use.

 **Rotitherm**

For **roasting** larger joints of meat or poultry on one level. The function is also suitable for cooking foods **au gratin** and **browning**.

The grill heating element and fan operate alternately.

Inserting the Shelf and Universal Baking Tray



Anti-tip device

All slide-in units have a small bulge on the left and right. This bulge is an anti-tip device and must always point to the rear of the oven.

Tray or universal baking tray:

The anti-tip device must point towards the rear of the oven.

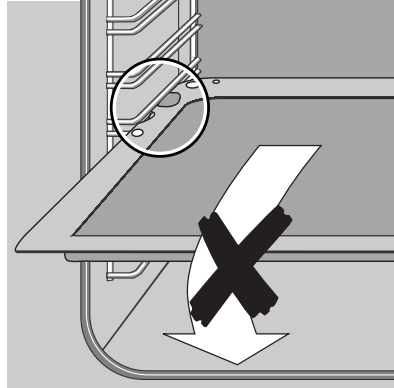

Inserting shelf:

Insert the shelf unit with both guide rails pointing upwards. The anti-tip device must point downwards and be positioned to the rear of the oven compartment.

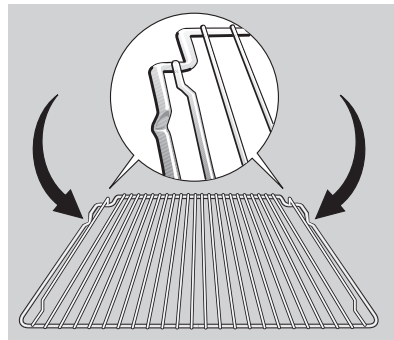

Inserting shelf and tray:

When the shelf unit and universal baking tray are used together, carefully place the shelf anti-tip device in the bulges on the tray.

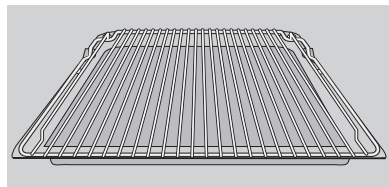

Attaching/Removing the Grill Pan Handle

The handle is particularly useful for removing the grill pan and tray more easily from the hot oven.

Attaching the handle

Insert **the handle** at an angle from above into the recess in the side of the grill pan (1) lift it gently and then lower it (2) until you hear it click into place.



Warning: Risk of burning!

Important: Check that the handle is securely attached!

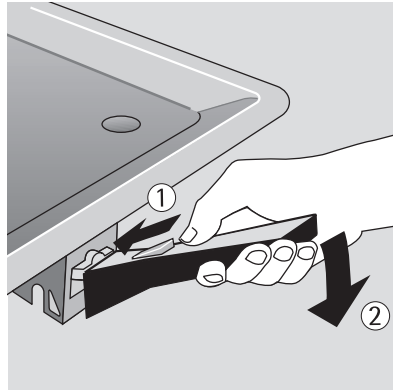

Removing the handle

Press the release button on the top of the handle (1) and lift up the handle (2) to remove it.



Important: Never leave the handle in the heated oven! Overheating can cause the handle to deform or break.

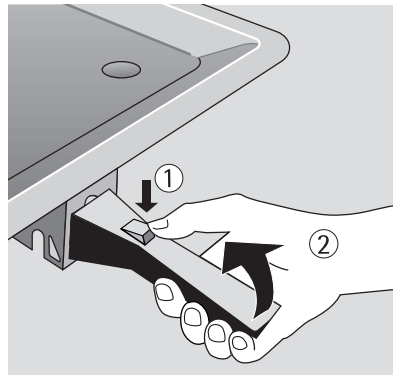

Working with the Electronic Clock

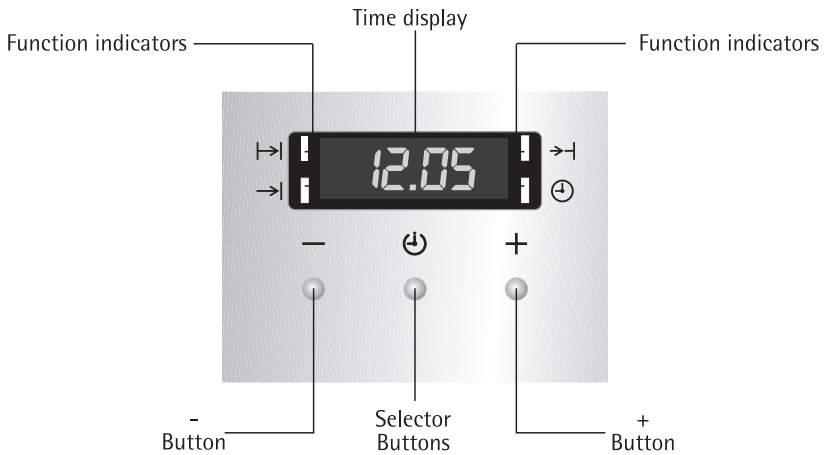

The electronic clock has the following functions:

Countdown

To set a countdown. A signal sounds after the time has elapsed. This function does not affect the functioning of the oven.

Cook time

To set how long the oven is to be in use.

End time





To set when the oven is to switch off again.

Time

To set, change or check the time.
(See also section "Before Using for the First Time".)



General information

- Once a function has been selected the corresponding function indicator will flash for approx. 5 seconds. During this time the required times can be set using the  or  button.
- After the required time has been set the function indicator will flash again for approx. 5 seconds. After this the function indicator will stay on. The set time will begin to count down.
- The acoustic signal can be deactivated by pressing any button.
- The required oven function and temperature may be selected before or after setting the clock functions cook time  and end time .
- When the cooking time has expired turn the oven function switch and the temperature selection switch back to the off position.



Switching Off the Time Display

By switching off the time display you can save energy.



Switching off the time display

Hold down any two buttons until the display becomes dark (approx. 10 seconds).



Switching on the time display

Hold down any two buttons until the time reappears in the display (approx. 10 seconds).





The display can only be switched off if none of the clock functions cook time , end time  or countdown  are in use.

Countdown

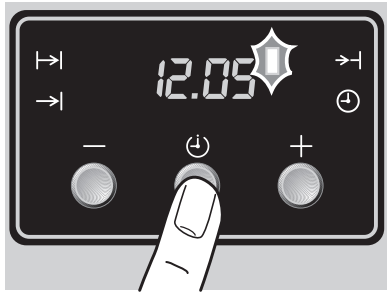
1. Press selection button  repeatedly until the countdown function indicator  flashes.



2. Using the  or  button set the required countdown . (Max. 2 hours and 30 minutes.)

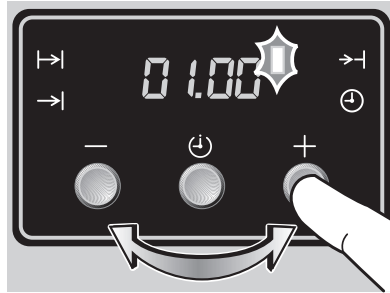

After approx. 5 seconds the display will show the remaining time. The countdown function indicator  is illuminated.

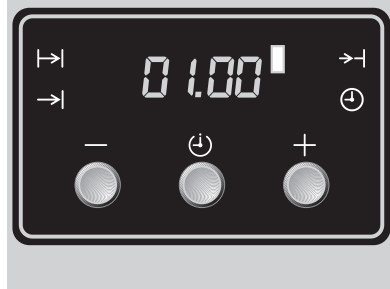



When the time has expired the function indicator will flash and an acoustic signal will sound for 2 minutes.

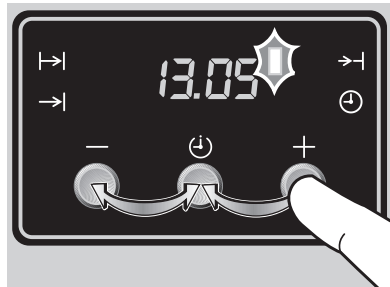

3. Press any button to switch off the acoustic signal.



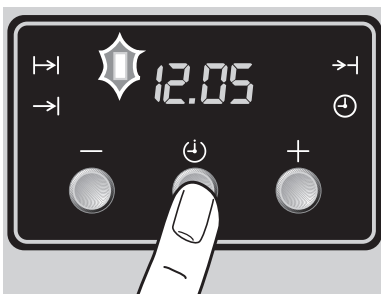

Cook time

1. Press selection button  repeatedly until the cook time function indicator  flashes.

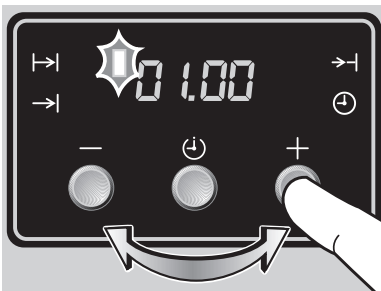

2. Using buttons  or  set the required cooking time.



After approx. 5 seconds the display will revert to the time. The cook time function indicator  is illuminated.





When the time has expired the function indicator will flash, an acoustic signal will sound for 2 minutes and the oven will switch off.

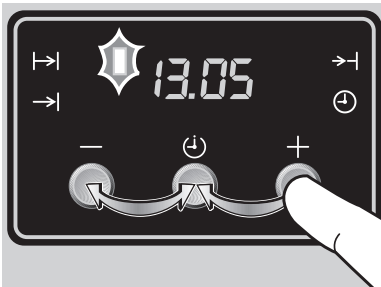

3. Switch off the acoustic signal and the programme by pressing any button.



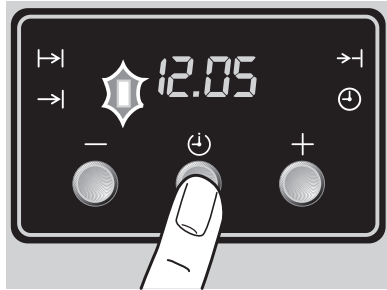

End time

1. Press selection button  repeatedly until the end time function indicator  flashes.

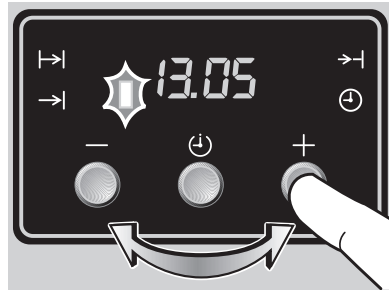

2. Using buttons  or  set the time at which you want the oven to switch off.



After approx. 5 seconds the display will revert to the time. The end time function indicator  is illuminated.



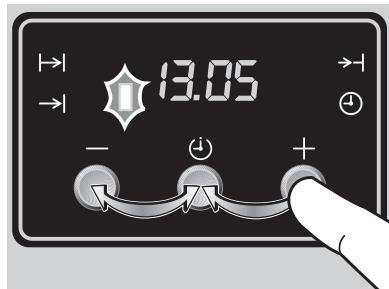

When the time has elapsed the function indicator will flash, an acoustic signal will sound for 2 minutes and the oven will switch off.

3. Switch off the acoustic signal and the programme by pressing any button.





Cook time and End time combined



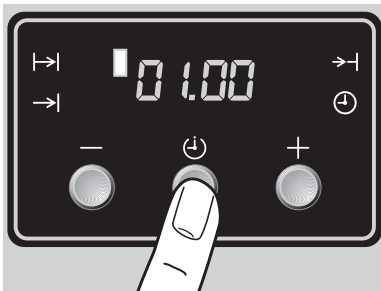

Cook time  and end time  can be used together if the oven is to switch on and off automatically at a **later time**.

1. Using the cook time  function set the time required for the dish to cook.
In this case 1 hour.

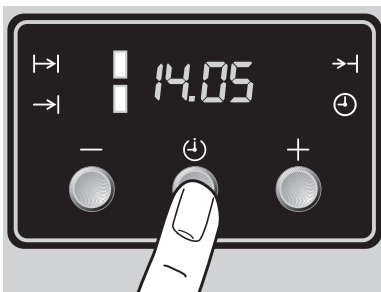

2. Using the end time  function set the time at which the dish is to be ready.
In this case 14:05.



The cook time  and end time  function indicators are illuminated and the time will appear in the display.
In this case 12:05.



The oven will switch on automatically at the calculated time.
In this case 13:05.

And will switch off again when the given time has expired.
In this case 14:05.

Changing TIME



The time can only be changed if neither of the automatic functions (cook time or end time) have been set.

1. Press selection button repeatedly until the TIME function indicator flashes.

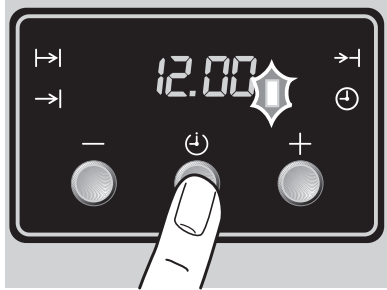

2. Using buttons or set the current time.

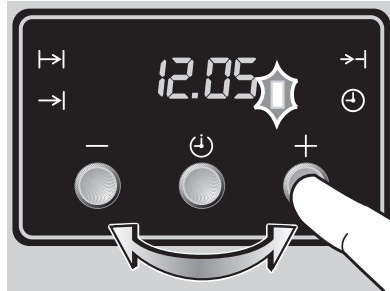



After approx. 5 seconds the function indicator will stop flashing and the clock will show the set time. The appliance is ready for use.





Usage, Tables and Tips



Baking

Use the baking , fan cooking  or conventional  oven function for baking.

Cake tins

- Cake tins made of dark metal and coated tins are suitable for conventional .
- Light tins are also suitable for baking  and fan cooking .

Shelf positions

- Baking using baking  or conventional  should be carried out on one level.
- You can bake on up to 3 levels simultaneously using fan cooking .

1 Baking Sheet:
Shelf Position 3

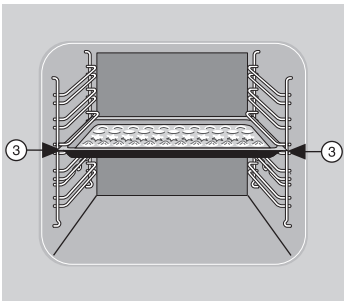

1 Cake Tin:
Shelf Position 1

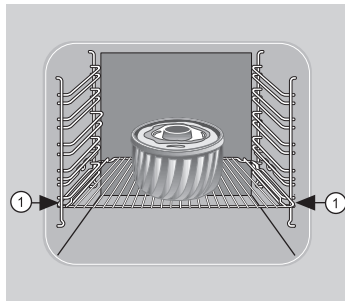

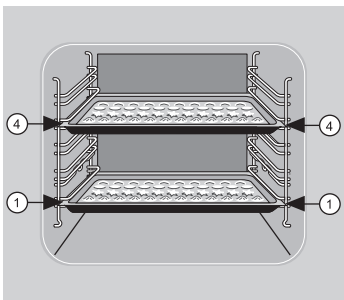

2 Baking Sheets:
Shelf Positions 1 and 4

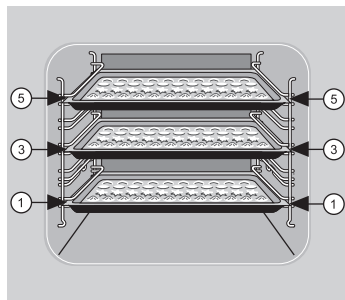

3 Baking Sheets:
Shelf Positions 1, 3 and 5



General information

- Please note that the shelf positions are counted from bottom to top.
- Always place cakes in cake tins in the middle of the shelf.
You can also bake two cakes simultaneously using baking  or conventional . In this case place the tins side by side on the shelf. The cooking time is then increased only slightly.
- Always preheat the oven when using the conventional  oven function.

Notes on the baking tables

In the tables you will find information on temperatures, cooking times and shelf positions for a selection of recipes.

- Ranges are given for the temperature and cooking time since these are dependent on the mixture, quantity and cake tin used.
- When baking several cakes on baking sheets or in cake tins, the cooking time can be 10-15 minutes longer.
- Moist items (e.g. pizzas, fruit cakes, etc.) should be cooked on a maximum of two levels.
- When using for the first time, we recommend setting the lower temperature. If increased browning is required or the cooking time is too long, select a higher temperature.
- If you cannot find any specific information for one of your own recipes, use information on a similar recipe for guidance.
- Variations in the height of the item to be baked can lead to different degrees of browning at the start of baking. In this case, **please do not change the temperature setting**. Variations in the amount of browning will even themselves out during baking.







Switch off the oven 10-15 minutes before the end of the cooking time to make use of the residual heat.

Unless otherwise stated the information in the tables applies for a cold oven.

Baking Tables

Baking on one level

Cakes, Biscuits, Bread, Pies	Baking 		Conventional 		Time
	Shelf position from bottom	Temp. °C	Shelf position from bottom	Temp. ¹ °C	Hours: Min.
Using cake tins					
Cakes in pound cake tins	1	150-160	1	160-170	1:00-1:10
Sandcakes/ Cakes in loaf tins	1	150-160	1	160-170	1:15-1:30
Madeira cake	1	150-160	1	160-170	1:00-1:10
Dundee cake	1	130-140	1	140-150	2:30-3:00
Large Christmas cake (10")	1	130	1	130-140	4:30-5:00
Victoria Sandwich	2	160	2	180-190	0:25-0:35
Pastry cases	3	180-190	2	210-220	0:10-0:25
Bakewell tart	-	160-170	1	180-190	0:45-0:55
Swiss roll	-	-	3	180-200	0:10-0:15
Flans Et quiches	2 or 1	170-180	2	180-200	0:30-0:50
Using baking sheets					
Short bread	3	140-150	3	150-170	0:40-0:50
Biscuits	3	150-170	3	180-200	0:15-0:25
Macaroons	3	140-150	3	150-170	0:25-0:35
Apple strudel	3	170-180 ¹	3	210-220	0:30-0:50
Choux pastry buns	3	160-170 ¹	3	200-210	0:20-0:35
Buns / cup cakes	3	150-160 ¹	3	190-210	0:25-0:35
Scones	3	200	3	220-240	0:10-0:15
Meringues	-	-	3	100-120	3:30-4:30

Cakes, Biscuits, Bread, Pies	Baking 		Conventional 		Time
	Shelf position from bottom	Temp. °C	Shelf position from bottom	Temp. ¹ °C	
Sausage rolls	3	170-180¹	3	210-220	0:20-0:35
Pizza	4	180-200	4	200-220	0:30-0:50
Bread					
Wholemeal bread	-	-	1	220-240	0:40-0:45
White bread	-	-	1	210-230	0:40-0:45

1) **Pre-heat oven.**

The figures printed bold indicate the **best oven function and temperature** to use in each case.

Select the lower temperature to start with, then select the higher one only if required.

Baking on several levels

Type of Cake or Pastry	Fan cooking 			Time Hr.: Min.
	Shelf position from bottom		Temp. °C	
	2 Levels	3 Levels		
Using cake tins				
Victoria Sandwich	1 + 4	-	160-170	0:25-0:35
Pastry cases	1 + 4	-	170-190	0:10-0:25
Using baking sheets				
Short bread	1 + 4	1. 3. & 5.	140-150	0:40-0:50
Biscuits	1 + 4	1. 3. & 5.	150-170	0:15-0:25
Macaroons	1 + 4	1. 3. & 5.	140-150	0:25-0:35
Choux pastry buns	1 + 4	-	160-170¹	0:20-0:35
Buns / cup cakes	1 + 4	1. 3. & 5.	150-160¹	0:25-0:35
Scones	1 + 4	-	190-200¹	0:10-0:15
Sausage rolls	1 + 4	-	170-180¹	0:20-0:35



1) Pre-heat oven.

Select the lower temperature to start with, then select the higher one only if required.

Tips on Baking

	Tip
This is how to tell if your cake is cooked through	Push a wooden skewer into the highest point of the cake. When no more cake mixture sticks to the wood, you can switch off the oven and utilise the residual heat.
The cake collapses (is sticky, not properly cooked through, water marks)	Check your recipe. Next time use less liquid. Observe mixing times, particularly when using kitchen appliances.
The cake is too light	Next time select a dark cake tin or place the cake one level lower.
Cake with moist topping/ cake is not cooked through, is unevenly browned	Next time bake at a lower temperature and increase the cooking time.

Table: Desserts



Desserts	Baking 		Conventional 		Fan Cooking 		Time Hr.: Min.
	Shelf position from bottom	Temp. °C	Shelf position from bottom	Temp. ¹ °C	Shelf position from bottom	Temp. °C	
Apple pie	3	180-190	1	210-220	2	180-190	0:45-0:50
Rice pudding	-	-	1	150	2	130-140	2:00-2:30
Fruit crumble	1	160	2	170-190	2	160	0:50-1:10
Pineapple upside down cake	2	160	2	180-190 ¹	2	160	0:35-0:45
Pavlova	2	130	2	140-150	2	130	1:00-1:10
Baked custard	-	-	2	160-170	2	150-160	0:45-1:00
Baked apples	2	160-170	2	190-210	2	160-170	0:40-1:00
Bread and butter pudding	2	170-180	2	200-210	2	170-180	0:40-0:55
Apple charlotte	2	180-190	2	210-220	2	180-190	0:40-0:55
Soufflé sweet/savoury	1	190-200	2	200-210	2	170-190 ¹	0:30-0:45

1) Pre-heat oven.

The figures printed in bold indicate the **best oven function and temperature** to use in each case.

Select the lower temperature to start with, then select the higher one only if required.

Roasting

For roasting, use the fan cooking , rotitherm  or conventional  oven function.

Roasting dishes



- Any heat-resistant dish is suitable for roasting.
- If the dish has plastic handles, ensure that the handles are heat-resistant.
- Large roasts can be roasted **directly on the universal sheet or on the shelf with the universal sheet underneath** (e.g. turkey, goose, 3-4 chickens, 3-4 knuckles).
- When roasting meat choose a dish which is just a little larger than the joint itself to retain the juices in a small area thus preventing fat from spitting and soiling the oven.
- We recommend roasting all lean types of meat **in a casserole with a lid** (e.g. veal, pork or beef pot roasts, frozen meat). This way the meat will remain moist.
- You can roast all types of meat that should have a crispy exterior **in a casserole without a lid** (e.g. pork, meat loaf, lamb, duck, 1-2 knuckles, 1-2 chickens, small poultry, sirloin, fillet, game).
- **Tip:** If you use dishes for roasting (particularly for small amounts), the oven will not get so dirty!

Shelf positions

- Please see the following table for the shelf positions to use.

Notes on the roasting tables



Information is given in the table on suitable oven functions, temperature settings, cooking times and shelf positions for various types of meat. The cooking times are for guidance only.



- We recommend roasting meat and fish **in the oven from a weight of 1 kg.**
- In general the conventional  function is suitable for very lean meat, fish and game.
- For all other types of meat (particularly poultry) we recommend the rotitherm  function, if you are just roasting meat without cooking any other type of food in the oven at the same time.
- If you wish to roast meat and cook other dishes at the same time, use the fan cooking  function.
- The cooking time required is dependent on the type and quality of the meat.
- To stop juices that exude from the meat burning onto dishes, we recommend adding a little liquid in the roasting dish.
- Turn the roast after approx. 2/3 of the cooking time.



Switch off the oven 10-15 minutes before the end of the cooking time to make use of the residual heat.

Table: Meat, roasting, casseroles

Meat	Fan Cooking 		Conventional 		Rotitherm 		Time Hrs. : Min.
	Shelf position from bottom	Temp. °C	Shelf position from bottom	Temp. °C	Shelf position from bottom	Temp. ² °C	
Pork							
Shoulder; leg; rolled; boned spare rib; loin of pork	2	170-180	2 or 1	190-210	2	150-160	0:30-0:35 per 450 g/1 lb plus 30-35 mins
Beef							
Inexpensive cuts	2	160-170	2	180-200	-	-	0:35-0:40 per 450 g/1 lb plus 15-20 mins
Prime cuts							
-rare	2	170-180¹	2	200-210 ¹	3 or 2	150-160 ¹	0:15-0:20 per 450 g/1 lb plus 15-20 mins
-medium	2	170-180	2	190-210	3 or 2	150-160	0:20-0:25 per 450 g/1 lb plus 25-25 mins
-well done	2	170-180	2	190-210	2	150-160	0:30-0:35 per 450 g/1 lb plus 25-30 mins
Yorkshire pudding							
- small	3	200¹	2	200-250	3	250	0:10-0:15
- large	2	180-190¹	2	210-250 ¹	2	220-230	0:30-0:40

Meat	Fan Cooking 		Conventional 		Rotitherm 		Time Hrs. : Min.
	Shelf position from bottom	Temp. °C	Shelf position from bottom	Temp. °C	Shelf position from bottom	Temp. ² °C	
Lamb	2	170-180	2	190-210	2	150-160	0:30-0:35 per 450 g/1 lb plus 30-35 mins
Veal	2	170-180	2	190-210	3 or 2	150-160	0:30-0:35 per 450 g/1 lb plus 30-35 mins



1) Pre-heat oven.



2) For Rotitherm roasting and joints of 5 lb & over eliminate the additional time.

The figures printed bold indicate the **best oven function and temperature** to use in each case.

Select the lower temperature to start with, then select the higher one only if required.

Table: Roasting, casseroles, au gratin

Poultry, Game, Fish, Vegetables	Quan- tity ap- prox.	Fan Cooking 		Conventional ¹ 		Rotitherm ² 		Time
		Shelf posi- tion from bot- tom	Temp. °C	Shelf posi- tion from bot- tom	Temp. °C	Shelf posi- tion from bot- tom	Temp. °C	
Casse- roles, misc.								
Casseroles	1 kg/ 2 lbs	2	150	2	160-170	-	-	2:30-3:00
Lancashire Hot Pot	1 kg/ 2 lbs	2	150-160	2	180-190	-	-	2:15-2:30
Moussaka	1 kg/ 2 lbs	2	170-180	2	210-215	-	-	0:40-0:50
Meat Loaf	675 g/ 1.5 lbs	2	170-180	2	200-210	2	160-170	1:00-1:10
Poultry/ Game								
Chicken	1 kg/ 2 lbs	2	170-180	2	200-220	2	160	0:50-1:10
Chicken	1.5 kg/ 3 lbs	2	170-180	2	200-220	2	160	1:15-1:30
Duck	1.5-2 kg/ 3.5-4 lbs	2	180-190	2 or 1	210-220	2	160	1:15-1:45
Goose	3.5-5 kg/ 8-10 lbs	2 or 1	170-180	2 or 1	200- 210/250	2 or 1	130-140	2:30-3:00
Turkey	2.5-3.5 kg 5-7 lbs	2	160	2 or 1	180-200	2 or 1	140-150	1:30-2:00
Turkey	4-6 kg/ 8-13 lbs	2 or 1	150-160	2 or 1	180-200	2 or 1	130-140	2:30-4:00

Poultry, Game, Fish, Vegetables	Quantity approx.	Fan Cooking 		Conventional ¹ 		Rotitherm ² 		Time Hr.: Min.
		Shelf position from bottom	Temp. °C	Shelf position from bottom	Temp. °C	Shelf position from bottom	Temp. °C	
Pheasant, Wild Duck, Rabbit	1 kg/ 2 lbs	3 or 2	210	3 or 2	210-220	3 or 2	170-180	0:30-1:00
Partridge/ Pigeon	per 300-500 g	3 or 2	190-200	3 or 2	210-220	3 or 2	170-180	0:30-0:50
Fish (baked, steamed)								
Whole fish	1-1.5 kg/ 2-3 lbs	2	160-170	2	190-210	3 or 2	150-160	0:45-1:15
Fish pies, bakes	750 g- 1 kg/ 1.5-2 lbs	3 or 2	170-190	3 or 2	210-220	3 or 2	160-180	0:30-1:00
Vegetables								
Stuffed pepper/au- bergines		2	180-190	2	210-225	3 or 2	160-180	0:30-1:00
Au gratin dishes		3	180-200	3	220-250	3	180-190	0:15-0:45

1) Pre-heat oven.

2) Place food in suitable containers and position wire shelf as per chart.

The figures printed bold indicate the **best oven function and temperature** to use in each case.

Select the lower temperature to start with, then select the higher one only if required.

Grilling

Use the single grill  or dual grill  oven function with a temperature of 275 °C for grilling.

Important: Always pre-heat the empty oven for 5 minutes using the grill function.

Ovenware for grilling

- For small amounts use the grill pan and the grill pan grid together for grilling.
- For larger amounts use the wire shelf and the meat tin together for grilling.



Warning: The **grill pan handle must be removed** whilst grilling! Always use oven gloves when removing or attaching the grill pan handle.

Shelf positions

- For grilling flatter foods, always use the **4th shelf position from the bottom.**

Notes on the grilling table

The grilling times are for guidance only and are dependent on the type and quality of the meat or fish.

- Grilling is particularly suitable for flat pieces of meat and fish.
- Turn over pieces of meat or fish halfway through the grilling time.



Warning: Always grill with the oven door shut. !

Grilling Table

Food		Shelf Level from down	Grilling Time minutes each side
Bacon rashers		4.	2-3
Beef burgers		4.	6-10
Chicken joints		4.	10-15
Chops:	Lamb Pork	4.	7-10 10-15
Fish:	Whole trout Hering Fillet plaice/cod	4.	8-12 4-6
Kebabs		4.	10-15
Kidneys:	Lamb/pig	4.	4-6
Liver:	Lamb/pig	4.	5-10
Sausages		4.	10-15 (turn as required)
Steaks:	rare medium well	4.	3-6 6-8 7-10

Defrosting

To defrost food, use the oven's defrosting function  at 30°C.

Defrosting dishes

- Put the food on a plate and put the plate on the tray.
- Use only parchment paper or film to cover the food. Do not use plates or dishes as they significantly increase the defrosting time.

Shelf levels

- For defrosting, insert the tray in the **2nd level from the bottom**.

Notes on the defrosting table

The table below gives you a few reference points on the defrosting times.

Defrosting Table

Meal	Defrosting time Min.	Standing time Min.	Note
Chicken, 1000 g	100-140	20-30	Place the chicken on an upside-down saucer on a large plate. Defrost open and turn after half the time, or defrost covered with film.
Meat, 1000 g	100-140	20-30	Defrost open and turn after half the time or cover with film.
Meat, 500 g	90-120	20-30	Defrost open and turn after half the time or cover with film.
Trout, 150 g	25-35	10-15	Defrost open
Strawberries, 300 g	30-40	10-20	Defrost open
Butter, 250 g	30-40	10-15	Defrost open
Cream, 2 x 200 g	80-100	10-15	Defrost open (Cream can also be whipped well if parts of it are still slightly frozen)
Flan, 1400 g	60	60	Defrost open.

Preserving

Use the bottom heat  oven function for preserving.

Preserving jars

- For preserving use only commercially available preserving jars that are all the same size.



Screw-top jars, jars with a bayonet fastening and metal containers are unsuitable.

Shelf positions

- Use the **1st shelf position from the bottom** for preserving.

Notes on preserving

- Use the universal tray for preserving. There is room for up to 6 preserving jars each with a capacity of 1 litre on this tray.
- The preserving jars should all be filled to the same level and closed.
- Position the preserving jars on the universal baking tray so that they do not come into contact with one another.
- Pour about 1/2 litre of water into the universal baking tray so that there is sufficient moisture in the oven.
- As soon as bubbles begin to appear in the liquid in the first jars (for 1-litre jars this takes about 35-60 minutes), switch off the oven or reduce the temperature to 100 °C (see table).

Preserving Table

Preserves	Temp. in °C	Preserving time until bubbles form Mins.	Continued cooking at 100 °C Mins.	Standing time with oven switched off
Soft fruit				
Strawberries, blueberries, raspberries, ripe gooseberries	160-170	35-45	-	-
Unripe gooseberries	160-170	35-45	10-15	-
Stone fruit				
Pears, quinces, plums	160-170	35-45	10-15	-
Vegetables				
Carrots	160-170	50-60	5-10	60
Mushrooms	160-170	40-60	10-15	60
Gherkins	160-170	50-60	-	
Mixed pickles	160-170	50-60	15	-
Kohlrabi, peas, asparagus	160-170	50-60	15-20	-
Beans	160-170	50-60	-	-
Plum purée	160-170	45-50	6-8 Hrs.	-

Cleaning and Care



Warning: For safety reasons cleaning the appliance with a steam jet cleaner or high-pressure water cleaner is **not permissible!**

Exterior of the Appliance

Wipe the front of the appliance with a soft cloth dipped in warm soapy water.

- Do not use scourers, caustic cleaners or abrasive items.
- Use commercially available cleaners for metal fronts.

Oven Interior

Oven lighting

You can switch on the oven light to make cleaning easier.

Cleaning

The walls that have a catalytic coating are self-cleaning. They absorb splashes of fat while the oven is in use.

To support this self-cleaning process, we recommend heating the oven without any food at regular intervals.

1. Remove all slide-in items from the oven.
2. Wash the oven floor with warm water and washing up liquid, then dry it.
3. Set the oven temperature to 250 °C.
4. Switch the oven off after one hour.
5. Wipe off any remaining soiling with a **soft** damp sponge.



Important! Do not use oven sprays or abrasive cleaners. Do not use soap or other cleaning agents. Doing so can damage the catalytic surface.



Over time the catalytic coating can discolour slightly. This does not affect its catalytic properties.

Accessories

Wash all slide-in units (shelf unit, baking tray, shelf support rails etc.) after each use and dry well. Soak briefly to make them easier to clean.

Shelf Support Rails

The shelf support rails on the left and right hand sides of the oven can be removed for cleaning the side walls.

Removing the shelf support rails

First pull the front of the rail away from the oven wall (1) and then unhitch at the back (2).

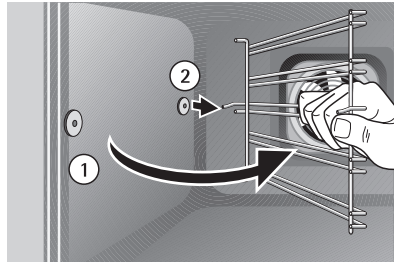
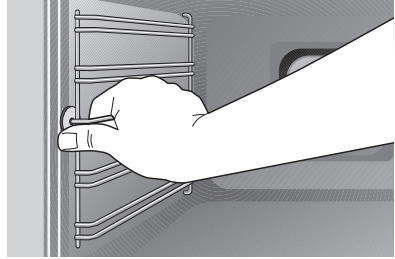

Fitting the shelf support rails



Important! The rounded ends of the guide rails must be pointing forwards!

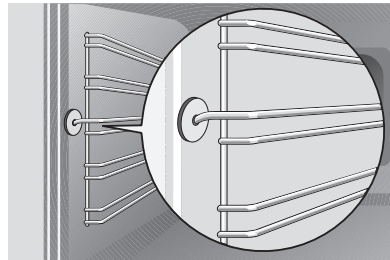

To re-insert, first hook the rail into place at the back (1) and then insert the front and press into place (2).

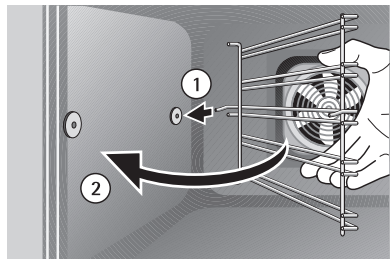

Oven Lighting



Warning: There is a danger of electric shock! Prior to changing the oven light bulb:

- Switch off the oven!
- Remove the fuses in the fuse box or switch off the circuit breaker.



Place a cloth on the oven floor to protect the oven light and glass cover.

Changing the rear oven light/Cleaning the glass cover

1. Remove the glass cover by turning it anti-clockwise and then clean it.
2. If necessary:
replace bulb with a 40 watt, 230 V, 300 °C heat-resistant, oven light bulb.
3. Refit the glass cover.

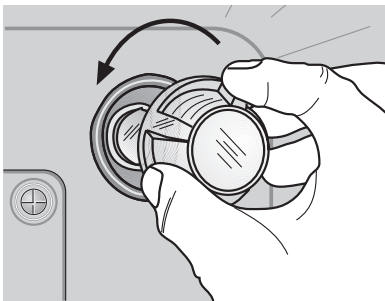

Changing side oven light/Cleaning glass cover

1. Remove the left shelf support rail.
2. Remove the glass cover with the aid of a narrow, blunt implement (e.g., teaspoon) and clean it.
3. If necessary:
replace bulb with a 25 watt, 230 V, 300 °C heat-resistant, oven light bulb.
4. Refit the glass cover.
5. Insert the shelf support rail.

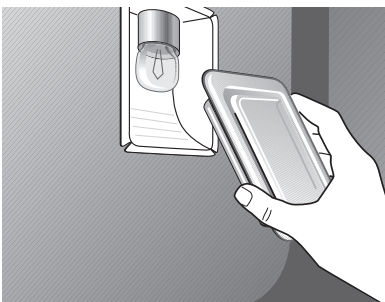
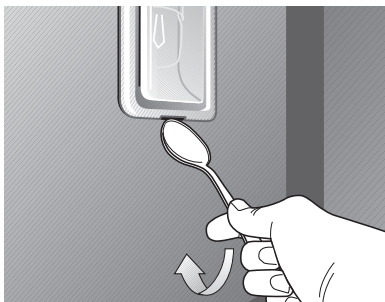

Oven Door

The oven door of your appliance may be removed for cleaning.

Removing the oven door

1. Open the oven door completely.
2. **Completely** fold back the **brass-coloured clamping lever** on **both** door hinges.
3. Grip the oven door with both hands on the sides and close it to about $\frac{3}{4}$ **going past the point of resistance**.
4. Pull the door away from the oven (**Caution: heavy!**).
5. Place the door, with the outer surface downwards, on a soft, flat surface, for example a blanket, to avoid scratches.

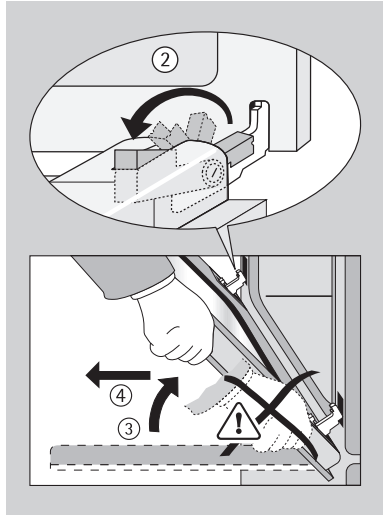

Hanging the oven door

1. With both hands take hold of the sides of the door from the side on which the handle is positioned.
2. Hold the door at an angle of approx. 60° .
3. Slide the door hinges **simultaneously** as far as possible into the two slots on the right and left at the bottom of the oven.
4. Lift the door up until resistance is met and then open fully.
5. Lift the brass-coloured clamping levers on both door hinges back to their original position.
6. Close the oven door.

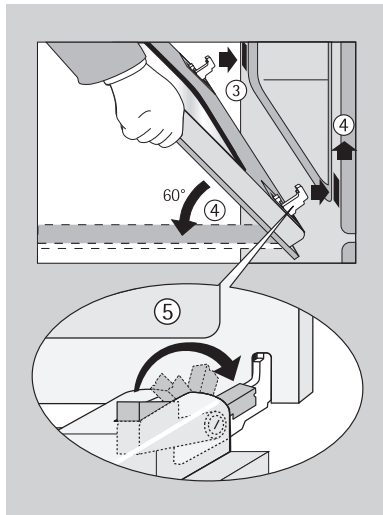

Oven Door Glass

The oven door is fitted with three glass panels mounted one behind the other. The inner panels may be removed for cleaning.



Warning: Carry out the following steps only when the oven door is un-hinged! When left on its hinges, the door could rise rapidly due to the lighter weight when the glass is removed and could cause injury.



Important: Using force, especially on the edges of the front glass panel, may break the glass.

Removing the top door glass

1. Unhinge the oven door and place it on a soft, flat surface with the handle facing down.
2. Take hold of the upper glass panel at the lower edge and slide it against the spring pressure in the direction of the oven door handle until it is free at the base.
3. Raise the panel **gently** at the base and pull out.

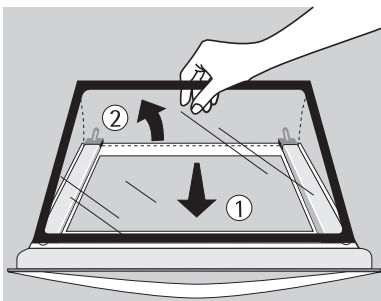

Removing the middle door glass

1. Grip the bottom edge of the middle glass panel and push it in the direction of the oven door handle until it is free at the base.
2. Raise the panel gently at the base and pull out.

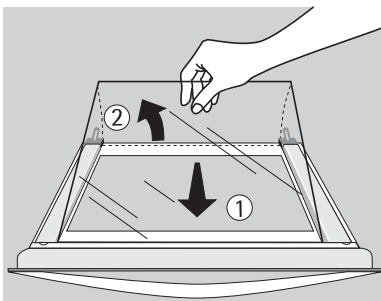

Clean the glass door panels

Inserting the middle door glass

1. Insert the middle glass panel at an angle from above into the section of the door in which the handle is located.
2. Lower the middle glass panel and slide it under the lower bracket towards the lower door edge as far as it will go.

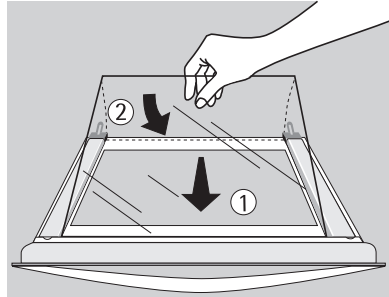

Inserting the upper door glass

1. Insert the upper glass panel at an angle from above into the section of the door in which the handle is located.
2. Lower the glass panel. Lay the panel against the spring on the lower door edge in front of the retaining section on the handle side and **slide it under the retaining section**. The glass panel must be firmly in position!

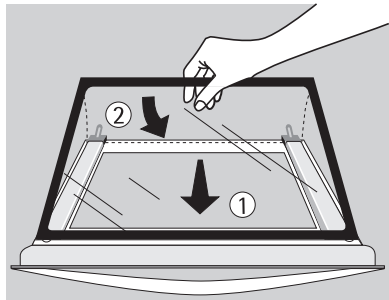

Re-hang the oven door

What to do if ...

Symptom	Possible cause	Solution
The oven does not heat up.	The oven has not been switched on.	Switch on the oven.
	The time has not been set.	Set the time.
	The necessary settings have not been made.	Check the settings.
	The circuit breaker (at the household fuse box) has tripped or the fuse has blown.	Check the fuse. If the circuit breaker trips or the fuse blows several times please call an approved electrician.
The oven lighting does not come on.	The oven light bulb has blown.	Replace the light bulb in the oven (see Cleaning and Care).

If you cannot rectify the fault with the help of the information given above please contact your local Service force Centre.



Warning: Repairs to the appliance must be carried out by qualified service engineers! Improper repairs can give rise to significant hazards for the user. If your appliance needs repairing, please contact your local AEG Service Force Centre.

In-guarantee customers should read the above section, as the engineer will make a charge if the fault is not a mechanical or electrical breakdown.

Information for appliances with a metal front:



Due to the cold front of your appliance the inner door glass may steam over briefly if you open the door during or shortly after baking or roasting.

Technical Data

Oven Interior Dimensions

Height x Width x Depth	31 cm x 41 cm x 41 cm
Capacity (usable capacity)	52 l

Regulations, Standards, Directives

This appliance meets the following standards:

- EN 60 335-1 and EN 60 335-2-6
relating to the safety of electric appliances for household use and similar purposes and
- EN 60 350 or DIN 44546 / 44547 / 44548
relating to the operating features of household electric cookers, hobs, ovens, and grills.
- EN 55014-2 / VDE 0875 Part 14-2
- EN 55014 / VDE 0875 Part 14 / 1999-10
- EN 61000-3-2 / VDE 0838 Part 2
- EN 61000-3-3 / VDE 0838 Part 3
relating to basic requirements for electromagnetic compatibility (EMC).

CE This appliance complies with the following EC directives:

- 73/23/EEC dated 19.02.1973 (Low Voltage), including amendment 90/683/EEC
- 89/336/EEC dated 03.05.1989 (EMC) including Amendment 92/31/EEC
- 93/68/EWG (markings and labelling).

Installation Instructions



Important: Any electrical installation work must be carried out by a qualified electrician/competent person.

The oven must be installed according to the instructions supplied.



Safety Instructions for the Installer

- Protection against access to live parts must be guaranteed by the installation.
- The unit in which the appliance is fitted must satisfy the requirements of DIN 68930 in respect of stability.
- This oven must be installed by qualified personnel to the relevant Standards.
- This oven is heavy. Take care when moving it
- Remove all packaging, both inside and outside the oven before using the oven.
- Do not attempt to modify the oven in any way.
- The built-in cooker and hobs are fitted with special connector systems. They may only be combined with units of the corresponding system.

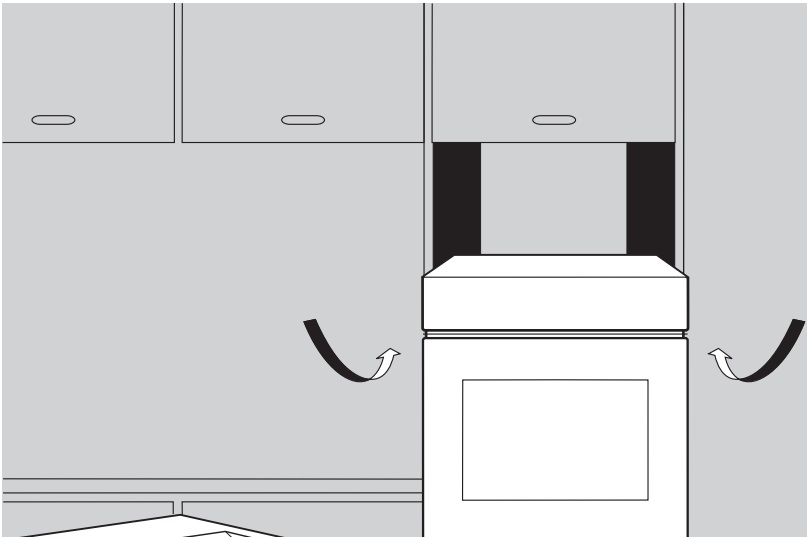

1 This oven can be installed either in-column as shown or under a counter

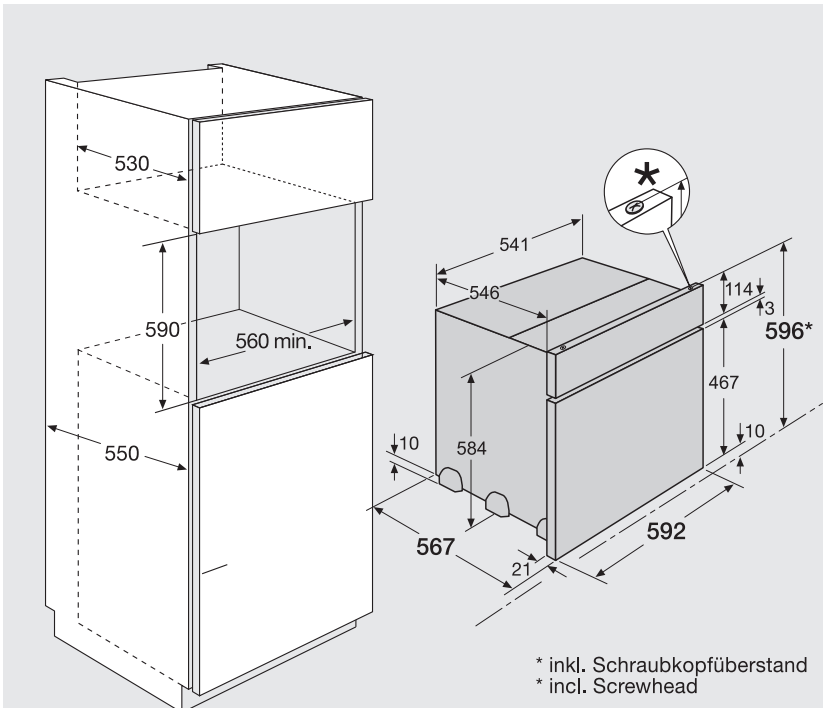

2

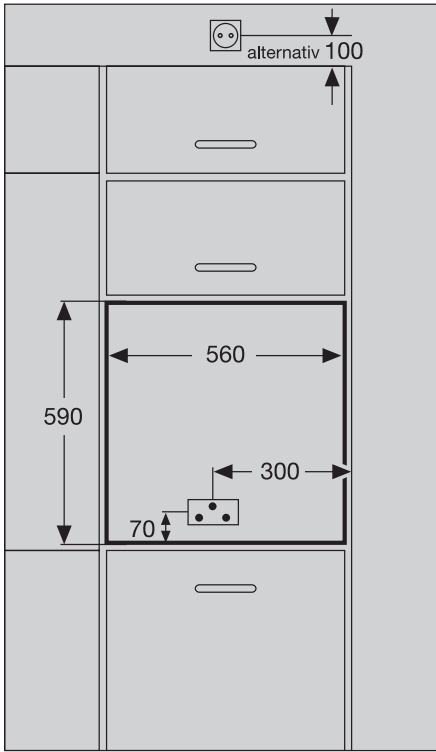

3

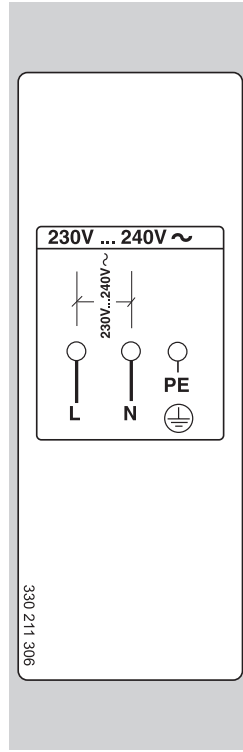

4

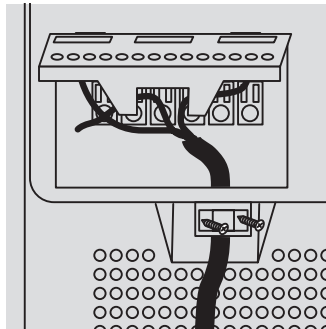

5

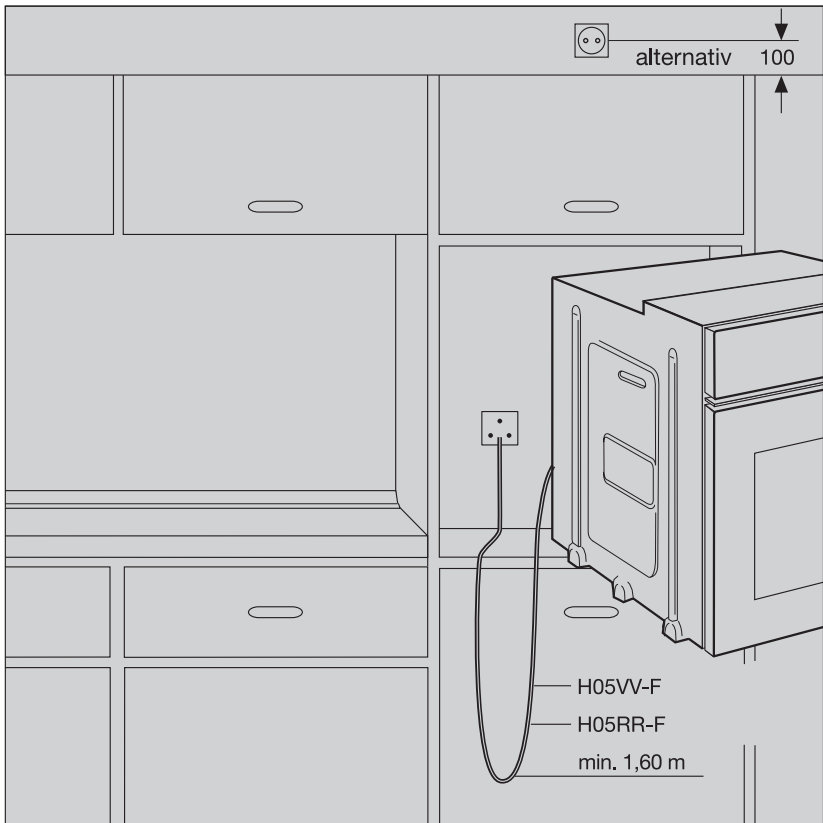

6

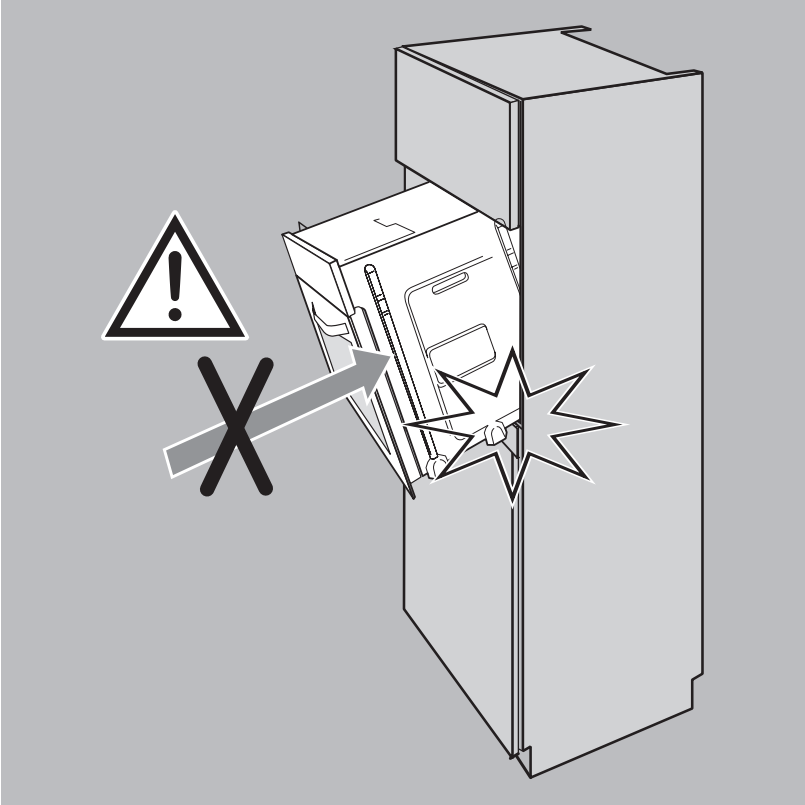

7

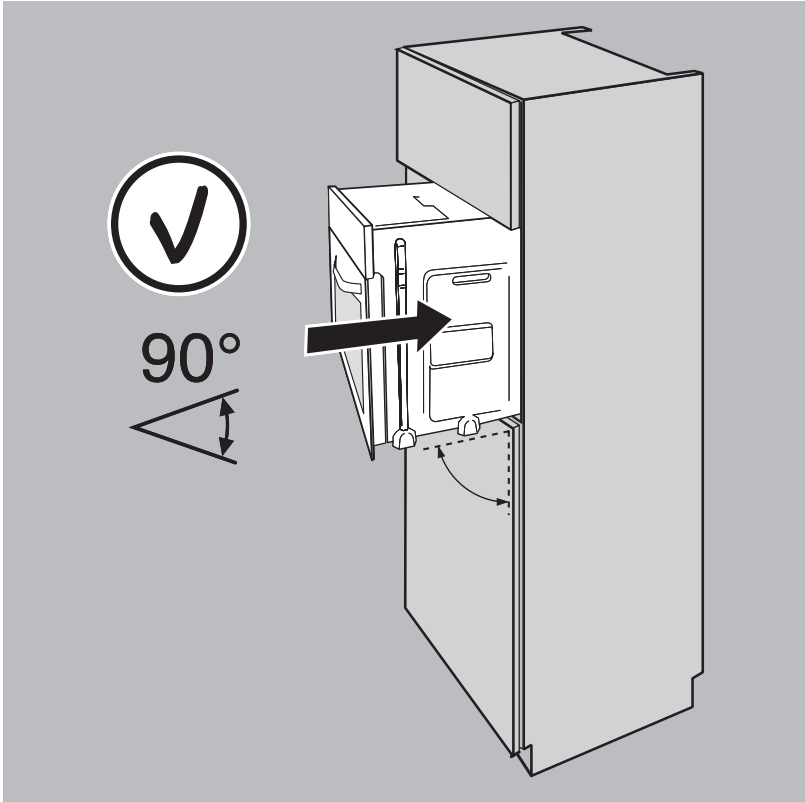

8

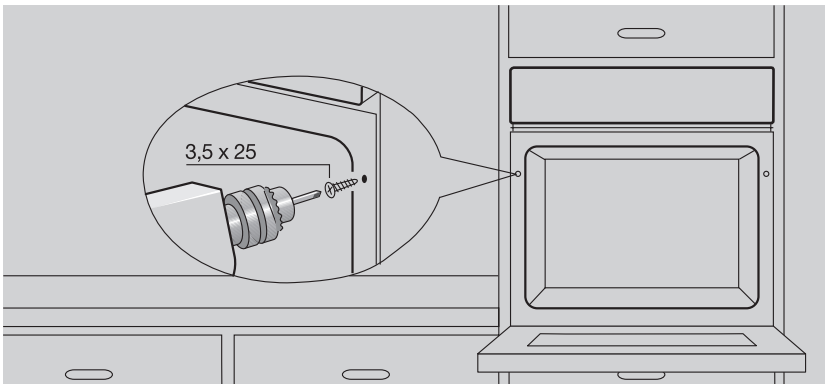

9

Warranty conditions

Great Britain

Guarantee Conditions

AEG offer the following guarantee to the first purchaser of this appliance.

1. The guarantee is valid for 12 months commencing when the appliance is handed over to the first retail purchaser, which must be verified by purchase invoice or similar documentation.
The guarantee does not cover commercial use.
2. The guarantee covers all parts or components which fail due to faulty workmanship or faulty materials. The guarantee does not cover appliances where defects or poor performance are due to misuse, accidental damage, neglect, faulty installation, unauthorised modification or attempted repair, commercial use or failure to observe requirements and recommendations set out in the instruction book.
This guarantee does not cover such parts as light bulbs, removable glassware or plastic, dust bags or filters.
3. Should guarantee repairs be necessary the purchaser must inform the nearest customer service office (manufacturer's service or authorised agent). AEG reserves the right to stipulate the place of the repair (i. e. the customer's home, place of installation or AEG workshop).
4. The guarantee or free replacement includes both labour and materials.
5. Repairs carried out under guarantee do not extend the guarantee period for the appliance. Parts removed during guarantee repairs become the property of AEG.
6. The purchaser's statutory rights are not affected by this guarantee.

European Guarantee

If you should move to another country within Europe then your guarantee moves with you to your new home subject to the following qualifications:

- The guarantee starts from the date you first purchased your product.
- The guarantee is for the same period and to the same extent for labour and parts as exist in the new country of use for this brand or range of products.
- This guarantee relates to you and cannot be transferred to another user.
- Your new home is within the European Community (EC) or European Free Trade Area.
- The product is installed and used in accordance with our instructions and is only used domestically, i. e. a normal household.
- The product is installed taking into account regulations in your new country.

Before you move please contact your nearest Customer Care Centre, listed below, to give them details of your new home. They will then ensure that the local Service Organisation is aware of your move and able to look after you and your appliances.

France	Senlis	+33 (0) 44 62 29 29
Germany	Nürnberg	+49 (0) 800 234 7378
Italy	Pordenone	+39 (0) 800 117511
Sweden	Stockholm	+46 (0) 8 672 5360
UK	Slough	+44 (0) 1753 219899

Customer Service Centres

Great Britain

For general enquiries or information regarding AEG appliances contact:
Customer Services Department
AEG Domestic Appliances
55-77 High Street
Slough
Berkshire
SL1 1DZ
Tel.: 08705 350 350

INDEX

A

Accessories 15

B

Bottom heat 13

C

Cleaning

accessories 42

initial cleaning 11

oven 42

oven door 45

shelf support rails 43

Clock 17

changing time 23

cook time 20

countdown 19

end time 21

setting the time 17

Combination shelf 9

Control panel 7

Conventional 13

Customer Service 57

D

Defrost 13

Description of the appliance 7

Disposal 6

Door 45

Dual grill 14

F

Fan cooking 13

Fan run-on 8

G

Grill 14

I

Insert anti-tip 15

L

Lighting 44

O

Oven

accessories 9

door 45

functions 13

light 44

operating 12

P

Pizza & baking 13

Preserving 40

R

Repairs 5

Rotitherm 14

S

Safety 5

Shelf 15

Shelf support rails 43

Steam vent 8

Switching off the time display 18

T

Tables and tips 24

U

Universal baking tray 9, 15

W

Warranty 56

What to do if 48

Service and Spare parts

In the event of your appliance requiring service, or if you wish to purchase spare parts, please contact Service Force by telephoning:

08705 929 929

Your telephone call will be automatically routed to the Service Force Centre covering your post code area.

For the address of your local Service Force Centre and further information about Service Force, please visit the website at www.serviceforce.co.uk

Before calling out an engineer, please ensure you have read the details under the heading „What to do if.....“

When you contact the Service Force Centre you will need to give the following details:

1. Your name, address and post code.
2. Your telephone number
3. Clear and concise details of the fault.
4. The model and serial number of the appliance (found on the rating plate).
5. The purchase date

Please note that a valid purchase receipt or guarantee documentation is required for in-guarantee service calls.

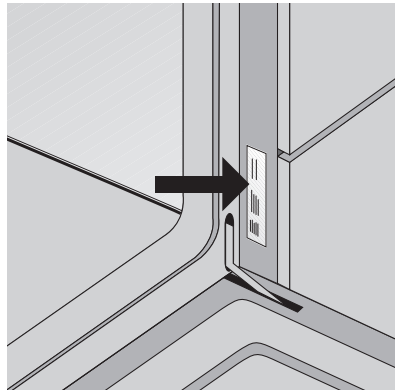

Customer Care

For general enquiries concerning your AEG appliance or for further information on AEG products please contact our Customer Care Department by letter or telephone at the address below or visit our website at www.aeghome.co.uk.

Customer Care Department
 AEG Domestic Appliances
 55-77 High Street
 Slough
 Berkshire, SL1 1DZ
 Tel. 08705 350350 (*)

(*) Calls may be recorded for training purposes

 **From the Electrolux Group. The world's No. 1 choice.**

The Electrolux Group is the world's largest producer of powered appliances for kitchen, cleaning and outdoor use. More than 55 million Electrolux Group products (such as refrigerators, cookers, washing machines, vacuum cleaners, chain saws and lawn mowers) are sold each year to a value of approx. USD 14 billion in more than 150 countries around the world.

AEG Hausgeräte GmbH
Postfach 1036
D-90327 Nürnberg

<http://www.aeg.hausgeraete.de>

© Copyright by AEG

822 947 669-A-050902-08

Subject to change without notice