

DAEWOO

MICROWAVE OVEN

KOR-634R

OPERATING
INSTRUCTIONS

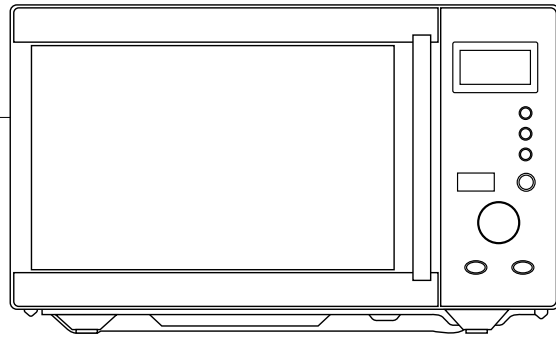

Before operating this oven, please read these instructions completely.

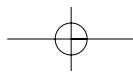

PRECAUTIONS TO AVOID POSSIBLE EXPOSURE TO EXCESSIVE MICROWAVE ENERGY

- (a) **Do not attempt to operate this oven with the door open** since open-door operation can result in harmful exposure to microwave energy. It is important not to defeat or tamper with the safety interlocks.
- (b) **Do not place any object** between the oven front face and the door or allow soil or cleaner residue to accumulate on sealing surfaces.
- (c) **WARNING** : If the door or door seals are damaged, the oven must not be operated until it has been repaired by a trained person : (1) door (bent), (2) hinges and latches(broken or loosened), (3) door seals and sealing surfaces.
- (d) **WARNING** : It is hazardous for anyone other than a trained person to carry out any service or repair operation which involves the removal of any cover which gives protection against exposure to microwave energy.
- (e) **WARNING** : Liquids or other foods must not be heated in sealed containers since they are liable to explode.
- (f) **WARNING** : Only allow children to use the oven without supervision when adequate instructions have been given so that the child is able to use the oven in a safe way and understands the hazards of improper use.

TABLE OF CONTENTS

PRECAUTIONS	1
EARTHING INSTRUCTIONS	2
INSTALLATION.....	2
SPECIFICATIONS	3
IMPORTANT	3
IMPORTANT SAFETY INSTRUCTIONS.....	4
FEATURES DIAGRAM	5
OPERATION PROCEDURE.....	7
CONTROLS	8
SETTING THE CLOCK	8
WEIGHT DEFROSTING	8
TIME DEFROSTING.....	9
COOKING IN ONE STAGE	10
COOKING IN TWO STAGES	10
EASY COOK	11
AUTO COOK.....	11
CHILD SAFETY LOCK.....	12
TO STOP THE OVEN WHILE THE OVEN IS OPERATING.....	12
COOKING UTENSILS.....	13
CARE AND CLEANING	13
BEFORE YOU CALL FOR SERVICE	14
QUESTIONS AND ANSWERS	14

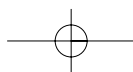

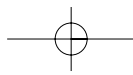

EARTHING INSTRUCTIONS

This appliance must be earthed. In the event of an electrical short circuit, earthing reduces the risk of electric shock by providing an escape wire for the electric current. This appliance is equipped with a cord having a earthing wire with a earthing plug. The plug must be plugged into an outlet that is properly installed and earthed.

WARNING : Improper use of the earthing plug can result in a risk of electric shock. Consult a qualified electrician or serviceman if the earthing instructions are not completely understood, or if doubt exists as to whether the appliance is properly earthed. If it is necessary to use an extension cord, use only a 3-wire extension cord that has a 3-blade earthing plug, and a 3-slot receptacle that will accept the plug on the appliance. The marked rating of the extension cord should be equal to or greater than the electrical rating of the appliance.

INSTALLATION

1 Steady, flat location

This oven should be set on a steady, flat surface. This oven is designed for counter top use only.

2 Leave space behind and side

All air vents should be kept a clearance. If all vents are covered during operation, the oven may overheat and, eventually, oven failure.

3 Away from radio and TV sets

Poor television reception and radio interference may result if the oven is located close to a TV, Radio antenna, feeder and so on. Position the oven as far from them as possible.

4 Away from heating appliance and water taps

Keep the oven away from hot air, steam or splash when choosing a place to position it, or the insulation might be adversely affected and breakdowns occur.

5 Power supply

- Check your local power source. This oven requires a current of approximately 6 amperes, 230V 50Hz.
- Power supply cord is about 0.8 meters long.
- The voltage used must be the same as specified on this oven. Using a higher voltage may result in a fire or other accident causing oven damage. Using low voltage will cause slow cooking. We are not responsible for damage resulting from use of this oven with a voltage of ampere fuse other than those specified.
- If the supply cord is damaged, it must be replaced by the manufacturer or its service agent or a similarly qualified person in order to avoid a hazard.

6 Examine the oven after unpacking for any damage such as:

A misaligned door, Broken door, A dent in cavity. If any of the above are visible, DO NOT INSTALL, and notify dealer immediately.

7 Do not operate the oven if it is colder than room temperature.

(This may occur during delivery in cold weather.) Allow the oven to become room temperature before operating.

8 The minimum height of free space necessary above the top surface of the oven is 100mm.

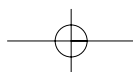

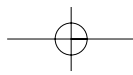

SPECIFICATIONS

POWER SUPPLY		230V AC 50 Hz SINGLE PHASE WITH EARTHING
MICROWAVE	POWER CONSUMPTION	1200 W
	OUTPUT POWER	800 W
	FREQUENCY	2450 MHz
OUTSIDE DIMENSIONS (W X H X D)		465 X 279 X 360 mm
CAVITY DIMENSIONS (W X H X D)		290 X 220 X 306 mm
NET WEIGHT		APPROX. 13KG
TIMER		59 min. 00sec.
POWER LEVELS		5 LEVELS

* Specifications are subject to change without notice.

IMPORTANT

The wires in this mains lead fitted to this appliance are coloured in accordance with the following code.

Green-and-yellow : Earth
 Blue : Neutral
 Brown : Live

As the colours of the wires in the mains lead of this appliance may not correspond with the coloured markings identifying the terminals in your plug, proceed as follows: the wire which is coloured green-and-yellow must be connected to the terminal in the plug which is marked with the letter 'E', the earth symbol or coloured green-and-yellow. The wire which is coloured blue must be connected to the terminal which is marked with the letter 'N' or coloured black.

The wire which is coloured brown must be connected to the terminal which is marked with the letter 'L' or coloured red.

WARNING: This appliance must be earthed.

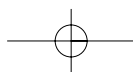

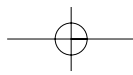

IMPORTANT SAFETY INSTRUCTIONS

WARNING : To prevent fire, burns, electric shock and other warnings:

Listed below are, as with all appliances, certain rules to follow and safeguards to assure high performance from this oven:

1. Do not use the oven for any reason other than food preparation, such as for drying clothes, paper, or any other nonfood items or for sterilizing purposes.
2. Do not use the oven when empty, this could damage the oven.
3. Do not use the oven cavity for any type of storage, such as papers, cookbook, cookware, etc.
4. Do not operate the oven without the glass tray in place. Be sure it is properly sitting on the rotating base.
5. Make sure you remove caps or lids prior to cooking when you cook food sealed in bottles.
6. Do not put foreign material between the oven surface and door. It could result in excessive leakage of microwave energy.
7. Do not use recycled paper products for cooking. They may contain impurities which could cause sparks and/or fires when used during cooking.
8. Do not pop popcorn unless popped in a microwave approved popcorn popper or unless it's commercially packaged and recommended especially for microwave ovens.
Microwave popped corn produces a lower yield than conventional popping; there will be a number of unpopped kernels. Do not use oil unless specified by the manufacturer.
9. Do not cook any food surrounded by a membrane, such as egg yolks, potatoes, chicken livers, etc., without first piercing them several times with a fork.
10. Do not pop popcorn longer than the manufacturer's directions. (popping time is generally below 3 minutes).
Longer cooking does not yield more popped corn, it can cause scorchings and fire.
Also, the cooking tray can become too hot to handle or may break.
11. If smoke is observed, switch off or unplug the appliance and keep the door closed in order to stifle any flames.
12. When heating food in plastic or paper containers, check the oven frequently due to the possibility of ignition.
13. The contents of feeding bottles and baby food jars are to be stirred or shaken and the temperature is to be checked before consumption, in order to avoid burns.
14. Always test the temperature of food or drink which has been heated in a microwave oven before you give it to somebody, especially to children or elderly people. This is important because things which have been heated in a microwave oven carry on getting hotter even though the microwave oven cooking has stopped.
15. Eggs in their shell and whole hard-boiled eggs shall not be heated in microwave ovens since they may explode.
16. Keep the waveguide cover clean at all times. Wipe the oven interior with a soft damp cloth after each use. If you leave grease or fat anywhere in the cavity it may overheat, smoke or even catch fire when next using the oven.
17. Never heat oil or fat for deep frying as you cannot control the temperature and doing so may lead to overheating and fire.
18. Microwave heating of beverages can result in delayed eruptive boiling, therefore care has to be taken when handling the container.

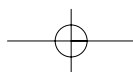

FEATURES DIAGRAM

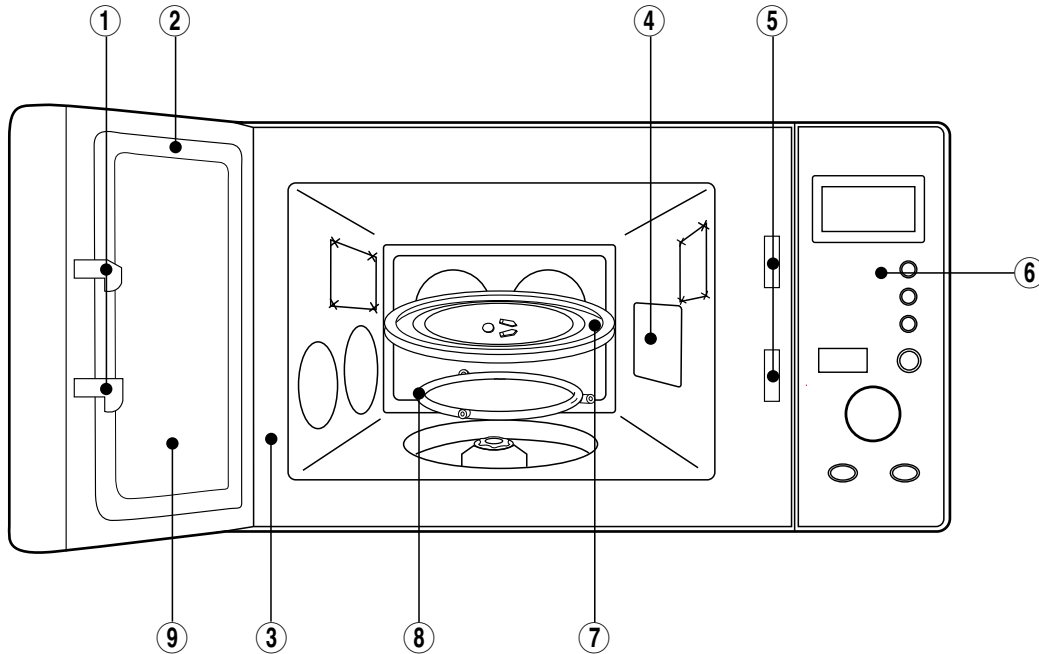

① **Door latch** - When the door is closed it will automatically shut off. If the door is opened while the oven is operating, the magnetron will automatically shut off.

② **Door seal** - The door seal maintains the microwave within the oven cavity and prevents microwave leakage.

③ **Oven cavity**

④ **Spatter shield** - Protects the microwave outlet from splashes of cooking foods.

⑤ **Safety interlock system** - Prevents the oven from operating while the door is opened.

⑥ **Control Panel**

⑦ **Glass cooking tray** - Made of special heat resistant glass. The tray must always be in proper position before operating. Do not cook food directly on the tray.

⑧ **Roller guide** - Supports the glass cooking tray.

⑨ **Door screen** - Allows viewing of food. The screen is designed so that light can pass through, but not the microwaves.

FEATURES DIAGRAM (continued)

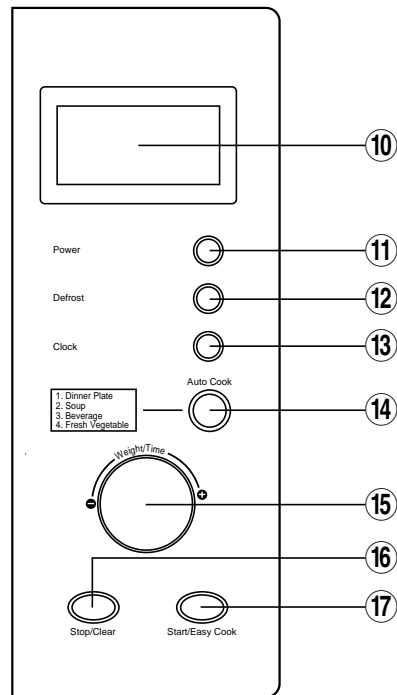

⑩ **Display** - Cooking time, Power level, indicators and present time are displayed.

⑪ **Power** - Used to set power level.

⑫ **Defrost** - Used to defrost by weight or time.

⑬ **Clock** - Used to dset clock.

⑭ **Auto cook** - Used to cook using a program or to reheat.

⑮ **Dial knob** - Used to set time and weight.

⑯ **Stop/Clear** - Used to stop the oven operation or to erase all entries.

⑰ **Start/Easy cook** - Used to start the oven operation and also increase the reheat time by 30 seconds.

OPERATION PROCEDURE

This section includes useful information about oven operation.

1. Plug power supply cord into a 230V 50Hz power outlet.
2. After placing the food in a suitable container, open the oven door and put it on the glass tray.
The glass tray and roller guide must always be in place during cooking.
3. Shut the door. Make sure that it is firmly closed.

1 The oven light is on only when the microwave oven is operating.

2 The oven door can be opened at any time during operation by touching the door release button on the control panel. The oven will automatically shut off.

3 Each time a button is touched, a BEEP will sound to acknowledge the touch.

4 The oven automatically cooks on full power unless set to a lower power level.

5 The display will show “ : 0” when the oven is plugged in.

6 Time clock returns to the present time when the cooking time ends.

7 When the Stop/Clear button is touched during the oven operation, the oven stops cooking and all information retained. To erase all information(except the present time), touch the Stop/Clear button once more. If the oven door is opened during the oven operation, all information is retained.

8 If the Start button is touched and the oven does not operate, check the area between the door and door seal for obstructions and make sure the door is closed securely. The oven will not start cooking until the door is completely closed or the program has been reset.

Make sure the oven is properly installed and plugged into the electrical outlet.

WATTAGE OUTPUT CHART

- The power-level is set by pressing the Power button. The chart shows the display, the power level and the percentage of power.

Touch Power button	Power level (Display)	Approximate Percentage of Power
once	P-HI	100%
twice	P-80	80%
3 times	P-60	60%
4 times	P-40	40%
5 times	P-20	20%

CONTROLS

SETTING THE CLOCK

When the oven is first plugged in, the display will flash “:0” and a tone will sound. If the AC power ever turns off, the display shows “:0” when the power comes back on.

Clock

1. Press Clock button.
This is a 12 hour clock system.
2. Press Clock button once more.
This is a 24 hour clock system.

NOTE : This oven has multiple clock systems. If you want 12 hour clock system, omit this step.

3. Turn the dial knob to adjust hour.

If you selected 12 hour system, the display will show the hours from “1” to “12”.
If you selected 24 hour system, the display will show the hours from “0” to “23”.
The adjusted hour starts blinking.

Clock

4. Press Clock button.

The minute stops blinking and “00” starts blinking.

The display will show the minutes from “0” to “59”.
The adjusted minute starts blinking.

5. Turn the dial knob to adjust minute.

Clock

6. Press Clock button.

When you press Clock button, the minute stops blinking, and the colon starts blinking. If you selected 12 hour clock system, this digital clock allows you to set from 1:00 to 12:59. If you selected 24 hour clock system, this digital clock allows you to set from 0:00 to 23:59.

WEIGHT DEFROSTING

WEIGHT DEFROST lets you easily defrost food by eliminating guesswork in determining defrosting time. The minimum weight for WEIGHT DEFROST is 200 gram and the maximum weight is 3,000 gram. Follow the steps below for easy defrosting.

Defrost

1. Press Defrost button.

The DEF. indicator & “0” appear and the g indicator starts blinking.

2. Turn the dial knob to adjust the defrosting weight.

The display will show what you selected.

Start

3. Press Start button.

When you press Start button, the g indicator disappears and the DEF. indicator starts blinking to show the oven is in the DEFROST mode. The display counts down the time to show you how much defrosting time is left in the DEFROST mode. The oven beeps during the defrosting cycle to signal that the food needs to be turned or rearranged. When the defrosting time ends, you will hear 3 beeps.

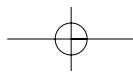

TIME DEFROSTING

When TIME DEFROST is selected, the automatic cycle divides the defrosting time into periods of alternating defrost and stand times by cycling on and off.

Defrost

1. Press Defrost button.

The DEF. indicator & "0" appear and the g indicator starts blinking.

2. Press Defrost button once more.

The g indicator disappears and ":0" is displayed.

3. Turn the dial knob to adjust the defrosting time.

The display will show what you selected.

NOTE: Your oven can be programmed for 59 minutes 00 seconds. (59:00)

Start

4. Press Start button.

When you press Start button, the DEF. indicator starts blinking to show the oven is the DEFROST mode. The display counts down the time to show you how much defrosting time is left in the DEFROST mode. The oven beeps during the defrosting cycle to signal that the food needs to be turned or rearranged. When the defrosting time ends, you will hear 3 beeps.

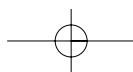

COOKING IN ONE STAGE

Power

X 3

1. Press Power button.
(Select the desired power level.)

The M/W indicator appears and the display will show what you selected.
This example shows power level 6.

NOTE: If step 1 is omitted, the oven will cook at full power.

2. Turn the dial knob to adjust the cooking time.

The display will show what you selected.

NOTE: Your oven can be programmed for 59 minutes 00 seconds.(59:00)

Start

3. Press Start button.

When you press Start pad, the M/W indicator starts blinking to show the oven is cooking.
The display counts down the time to show how much cooking time is left. When the cooking time ends, you will hear 3 beeps.

NOTE: Using lower power levels increases the cooking time which is recommended for foods such as cheese, milk and slow cooking of meats.

COOKING IN TWO STAGES

All recipes require frozen foods to be defrosted fully before cooking.
This oven can be programmed to automatically defrost foods before cooking.

Defrost

1. Press Defrost button.

The DEF. indicator & "0" appear and the g indicator starts blinking.

2. Turn the dial knob to adjust the defrosting weight.

The display will show what you selected.

Power

X 3

3. Press Power button.
(Select the desired power level.)

The M/W indicator appears and the display will show what you selected.
This example shows power level 6.

4. Turn the dial knob to adjust the cooking time.

The display will show what you selected.

Start

5. Press Start button.

When you press Start button, the DEF and M/W indicators come on to confirm the power levels selected.
The DEF. indicator starts blinking to show you that the oven is in DEFROST mode. The display counts down the time remaining in DEFROST mode. When the oven beeps, turn over, break apart and/or redistribute the food. At the end of DEFROST mode, the oven will beep and start M/W cook. The DEF. indicator disappears and the M/W indicator starts blinking. The display counts down the time remaining in M/W mode.
When M/W cook ends, you will hear 3 beeps.

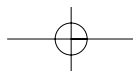

EASY COOK

EASY COOK allows you to reheat for 30 seconds at 100% (full power) by simply pressing the Easy cook button.

By repeatedly pressing the Easy cook button, you can also extend reheating time to 5 minutes by 30 seconds.

Easy cook	1. Press Easy cook button.	When you press Easy cook button, ":30" appears. After 1.5 seconds, the oven starts reheating. When the cooking time ends, you will hear 3 beeps.
------------------	----------------------------	--

AUTO COOK

AUTO COOK allows you to cook or reheat many of your favorite foods by repeatedly touching Auto cook button.

Auto cook	1. Press Auto cook button.	When you press AUTO COOK button once, "AC-1" is displayed. By repeatedly pressing this button, you can select one of the four menu programs as shown in the chart below.
	2. Turn the DIAL KNOB to adjust the desired quantity.	The display will show what you selected.

Food	Press Autocook button	Display	Weight	Directions
Dinner Plate	once	AC-1	350g	Put foods on the microwave plate and cover with vented plastic wrap.
			450g	
Soup	twice	AC-2	350g	Pour soup in microwave bowl or mug. Stir before serving.
			450g	
Beverage	three times	AC-3	1 CUP (200ml)	Pour beverage in microwave mug and place it on the turntable. Do not cover.
			2 CUPS (200mlx2)	
			3 CUPS (200mlx3)	Stir before serving.
Fresh vegetable	four times	AC-4	200g	Wash and put in casserole. Add no water if vegetables have just been washed. Cover tender vegetables with lid and stir after cooking.
			400g	

Start	3. Press Start button.	When you press Start button, the display changed into cooking time and the oven starts cooking. When the cooking time ends, you will hear 3 beeps.
--------------	------------------------	--

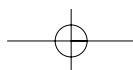

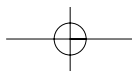

CHILD SAFETY LOCK

SAFETY LOCK lock prevents unwanted oven operation such as by small children.

To set, press and hold Stop/Clear button for 3 seconds, Lock indicator appears and a beep sounds.

To cancel, press and hold Stop/Clear button for 3 seconds, Lock indicator disappears and a beep sounds.

TO STOP THE OVEN WHILE THE OVEN IS OPERATING

1. Press Stop/Clear button.
 - You can restart the oven by pressing Start button.
 - Press Stop/Clear button once more to erase all instructions.
 - You must enter in new instructions.
2. Open the door.
 - You can restart the oven by closing the door and pressing Start button.

NOTE: Oven stops operating when door is opened.

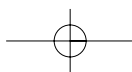

COOKING UTENSILS

Utensils should be checked to ensure that they are suitable for use in microwave ovens.

Microwave energy is produced by high frequency radio waves. They are reflected from metal, but will pass through most cooking utensils without heating them.

As the waves come into contact with the food, they are converted into heat energy. Listed below are the suggested cooking utensils for this microwave oven and when to use them.

1. Dishes with metal trim of any type-should not be used. This will cause sparking.
2. Glass or ceramic heat proof dishes-excellent for microwave cooking.
3. China dishes and plates-without metal trim may be used to cook and heat individual portions of food.
4. Wood or straw-use only for short period, wood contains some moisture and the microwave energy may cause the wood to dry out and crack.
5. Aluminum foil-may be used in very small pieces for shielding only.
Any aluminum foil used should never be closer than 2.5cm from side walls of oven.
6. Plastic-most heat resistant plastic dinnerware may be used for heating food. However polyethylene, melamine, phenol are unsuitable for use in the oven. They become hot in the microwave.
7. Wax paper-use as a cover to avoid splatters.
8. Metal-in general, metal utensils should not be used in microwave oven.

CARE AND CLEANING

Although your oven is provided with safety features, it is important to observe the following:

1. It is important not to defeat or tamper with safety interlocks.
2. Do not place any object between the oven front face and the door or allow residue to accumulate on sealing surfaces. Wipe the sealing area frequently with a mild detergent, rinse and dry. Never use abrasive powders or pads.
3. When opened, the door must not be subjected to strain, for example, a child hanging on an opened door or any load could cause the oven to fall forward to cause injury and also damage to the door. Do not operate the oven if it is damaged, until it has been repaired by a trained service technician. It is particularly important that the oven closes properly and that there is no damage to the:
 - i) Door(bent)
 - ii) Hinges and Hooks(broken or loosened)
 - iii) Door seals and sealing surfaces.
4. The oven should not be adjusted or repaired by anyone except a properly trained service technician.

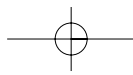

BEFORE YOU CALL FOR SERVICE

Refer to the following checklist, you may prevent an unnecessary service call.

- * The oven doesn't work;
 1. Check that the power cord is securely plugged in.
 2. Check that the door is firmly closed.
 3. Check that the cooking time is set.
 4. Check for a blown circuit fuse or tripped main circuit breaker in your house.
- * Sparking in the cavity;
 1. Check utensils. Metal containers or dishes with metal trim should not be used.
 2. Check that metal skewers or foil does not touch the interior walls.

If there is still a problem, contact the service station.

A list of these stations is included in the oven.

DO NOT ATTEMPT TO SERVICE THE OVEN YOURSELF !

QUESTIONS AND ANSWERS

- * **Q** : I accidentally ran my microwave oven without any food in it. Is it damaged?
A : Running the oven empty for a short time will not damage the oven. However, it is not recommended.
- * **Q** : Can the oven be used with the glass tray or roller guide removed?
A : No. Both the glass tray and roller guide must always be used in the oven before cooking.
- * **Q** : Can I open the door when the oven is operating?
A : The door can be opened anytime during the cooking operation. Then microwave energy will be instantly switched off and the time setting will maintain until the door is closed and START is touched.
- * **Q** : Why do I have moisture in my microwave oven after cooking?
A : The moisture on the side of your microwave oven is normal. It is caused by steam from cooking food hitting the cool oven surface.
- * **Q** : Dose microwave energy pass through the viewing screen in the door?
A : No. The metal screen bounces back the energy to the oven cavity. The holes are made to allow light to pass through. They do not let microwave energy pass through.

