

X - MICRO

X-Micro EVA 130 MP3 PLAYER

User Manual

V 1.0

CONTENTS

Precautions	1
System requirements	3
1.Installation insrtuction.....	4
1.1Install the driver	4
1.2Install the battery	4
2.USB mode.....	5
2.1Connect to the PC.....	5
2.2Download the music.....	5
2.3Remove the USB device	6
3.Basic operation	8
3.1Button and functions	8
3.2Power on / off	9
3.3Main menu	9
4.How to use this player.....	10
4.1Play music.....	10
4.2Voice mode	11
4.3FM Tuner.....	13

4.4	Setting menu	16
4.5	Previous function.....	17
4.6	About.....	17
4.7	Folder fucntion	18
4.8	Exit	19
5.	Other function.....	19
5.1	A-B play.....	19
5.2	Lock	20
5.3	Lyric sync	20
6.	FAQ.....	21
7.	Technical specifications.....	23

Precautions

- (1) Never use the player during driving or operating other vehicles to avoid traffic accident, which is also restricted by the law in some districts. Even on foot, it is still dangerous to listen in extremely high volume especially during crossing the street. Wherever with potential risks, please stop using the player for safety purpose.
- (2) Please insert the earphone before powering on the player, which can not only avoid damaging the earphone but keep the player in good condition.
- (3) Keep the player clean and away from heat source or direct sunlight, dirty, humid or rainy place.
- (4) If the surface is dirty, please clean with soft cloth dipped with clean water or soft abluent. Never clean the case with alcohol or diluents.
- (5) Never use the player in rather dry environment to avoid static.
- (6) Never disconnect the player from PC abruptly during downloading, uploading and formatting to avoid application failure.
- (7) When the player is used as removable disk, please follow the proper file download and upload procedures. Our company resumes no responsibility for any file lost due to improper operation.

- (8) As the software provided by original equipment manufacturer has the optimum flash storage speed, all players with memory less than 128MB cannot be formatted as FAT-32 in the operating system.

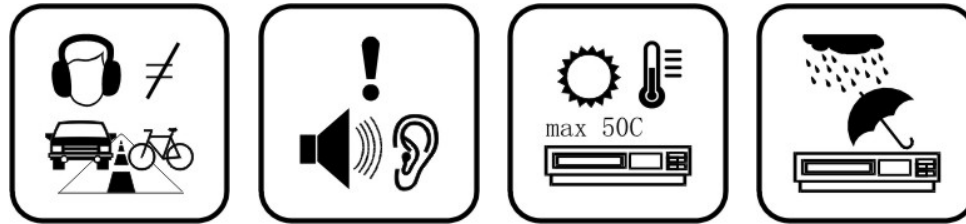

- (9) Attention: Because of the different memory calculating method and the player software (firmware) is stored in the device flash memory and, it will cause the difference between flash memory marked capacity and real capacity. The real flash memory capacity is lesser than the marked memory capacity of this device is normal. Due to different firmware size, it will have the different free flash memory capacity. Please refer the table as below for more details.

Marked capacity	Real capacity range	Free capacity range after stored firmware
128MB	122MB~128MB	73MB~127MB
256MB	244MB~256MB	191MB~255MB
512MB	488MB~512MB	428MB~511MB
1GB	953MB~1000MB	879MB~999MB
2GB	1907MB~2000MB	1804MB~1999MB

System requirements

System requirement of **X-Micro EVA 130 MP3 PLAYER**:

Mac OS V10.0 later version Linux OS kernel V2.4.0 later version

Microsoft[®] Windows 98se/2000/Me/XP

Pentium 200MHZ or above.

USB port

120MB hard disk space

Mouse installed

CD-ROM drive

1. Installation instruction

1.1 Install the driver

- A. Connect the X-Micro EVA 130 MP3 Player to the USB port of a PC, "Find new hardware" appears on the screen, then click "Search latest driver for this device" and insert the driver CD into CD-ROM, and then click "Next".
- B. Select "Look in" to direct the installation directory to the "Drivers" files in the driver CD, click Yes.
- C. PC will install the driver for Windows® 98SE automatically.

1.2 Install the battery

- A. Install one LR03 AAA size 1.5V alkaline or 1.2V NiMH battery properly upon indicator on the player.
- B. Press the ► || button to power the player on and enter the MUSIC standby mode.

2.USB mode

2.1 Connect to the PC

Before operation, please with USB port on this player inserted into the PC' USB port.
How to update the software or format the removable disk, please refer to the website.

2.2 Download the music

You can drag and drop the files and folders onto this removable device.

Data transferring



2.3 Remove the USB device

- A. Double click the Safely Remove Hardware icon in taskbar:



- B. From Safely Remove Hardware screen, highlight "USB Mass Storage Device" item, and then click "Stop" button. "Stop a Hardware Device" window appears on the screen as shown in the picture below.

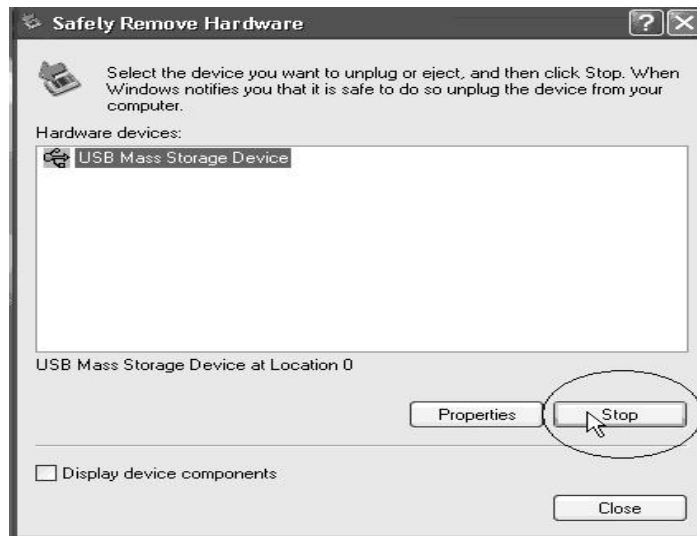

C. Click "OK". After the "Safe to Remove Hardware" window appears, the player can be disconnected from PC safely.



Notice: Never unplug the USB cable when transmitting data with PC to avoid damaging the Player; after data transmitting, please do not disconnect the player from PC until "Device now be safely removed" appears; while using USB function, all other buttons will be nonfunctional.

Any application lost or I/O error and power on issues caused by improper operations, please refer to FAQ.

3. Basic operation

3.1 Button and functions

- (1) Hold button
- (2) Menu button
- (3) I◀◀ Previous button
- (4) A-B/REC button
- (5) VOL- button
- (6) ▶▶ I Next button
- (7) Earphone jack button
- (8) VOL+ button
- (9) ▶ || Play/Pause/Stop button
- (10) Microphone button

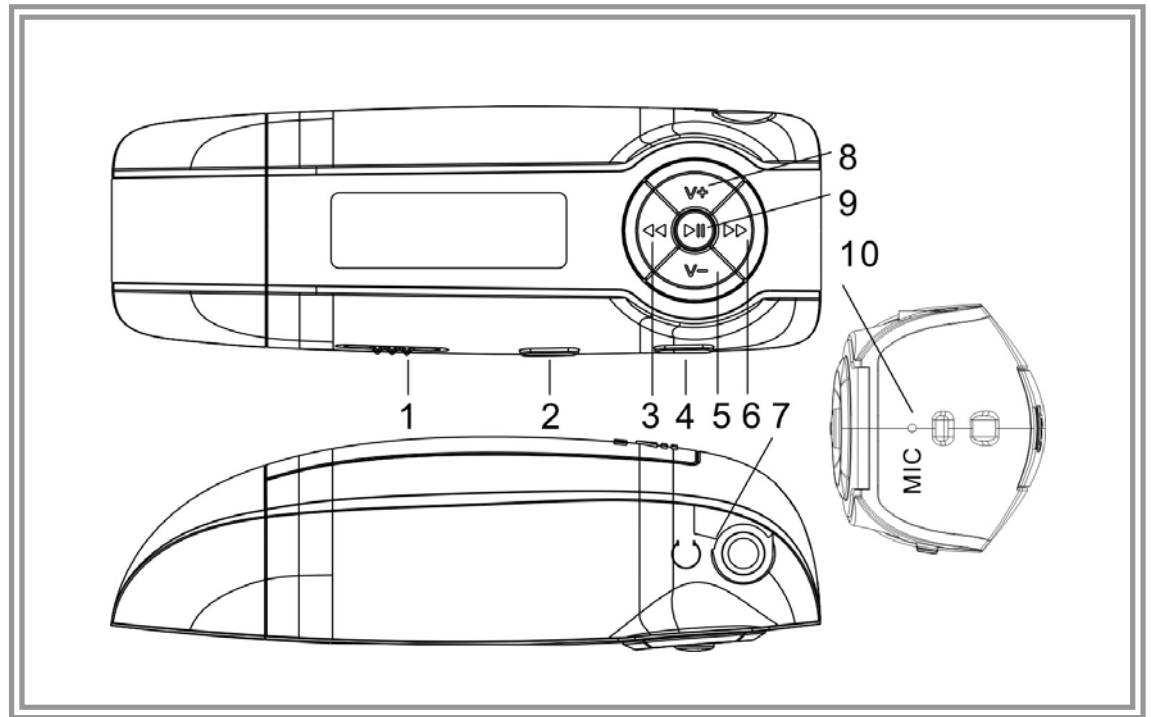

3.2 Power on / off

From power off mode, press the ▶ || button to power the player on and enter into the MUSIC standby mode; press the ▶ || button 3 seconds under any mode, the player will save the data and enter power off mode.

Standby mode

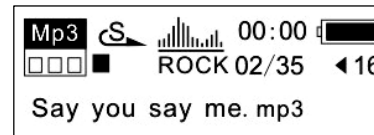

Notice: If you pick the battery out of the battery compartment to power the player off, all the data set can't be saved!

3.3 Main menu

From standby or playing mode, you can press the MENU button to enter the main menu.

Press the |◀ or ▶| button to select: Play music, Voice mode, FM Tuner, Setting, Preview, About, Folder and Exit; you can press the MENU button to enter the desired setting.

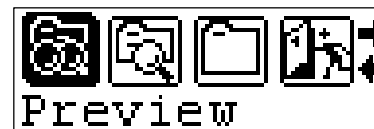
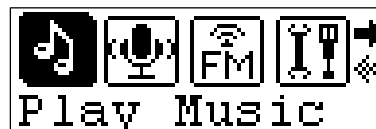

4.How to use

4.1 Play music

- A. From music standby mode, you can press the ▶ || button to play music and press the ▶ || button again to pause. To resume playing, please press the ▶ || button the third time.

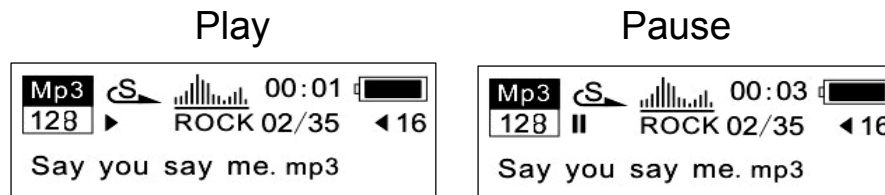

- B. From play or pause mode, hold the ▶ || button 2 seconds, the player will return to the music standby mode, press and hold the ▶ || button again, it will repeat step "A".
- C. From music standby or play mode, press the |◀◀ or ▶▶| button to select previous or next track.
- D. From stop status, you can press the |◀◀ or ▶▶| button to find your desired track quickly.
- E. From play mode, you can hold the |◀◀ or ▶▶| button to fast backward or forward in this track.
- F. From play mode, press the V + or V- button to adjust the volume.
- G. From music standby, play and pause mode, hold the ▶ || button for 3 seconds, the player will save the data and enter the power off mode.

4.2 Voice mode

Record function

From music mode or voice standby mode, press the A-B/REC button 2 seconds, the player will enter the recording mode, and press the A-B/REC button again to stop. You can press the ► || button to play voice, and press this button again to pause. To resume playing, please press this button a third time.

Recording

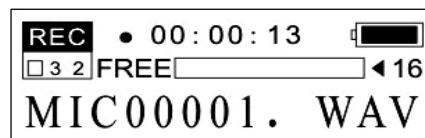

Stop recording

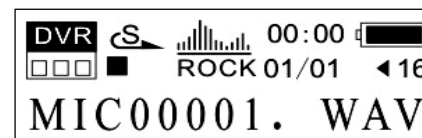

Playing voice

- A. From voice mode or voice standby mode, you can press the MENU button to enter the main menu. To enter the playing voice mode, please press the |◀◀ or ▶▶| button to select Voice and press the MENU button. You can press the ► || button to play, and press this button again to pause. To resume playing, please press this button a third time.

Play

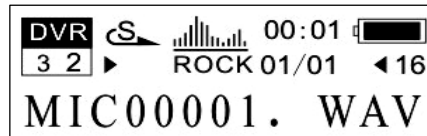

pause

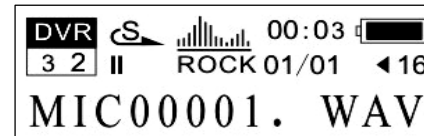

- B. From voice standby or play mode, you can hold the |◀◀ or ▶▶| button to select previous or next track.
- C. From stop status, you can press the |◀◀ or ▶▶| button to find your desired music quickly.
- D. From play mode, you can hold |◀◀ or ▶▶| button to fast backward or forward in this track.
- E. From play mode, press the V + or V- button to adjust the volume.
- F. From voice standby mode, hold the ▶ || button for 3 seconds, the player will be powered off.

Note: The EQ selection will be unavailable when playing the voice files.

4.3 FM Tuner

Playing FM

- A. From music playing, voice playing or standby mode, you can press the MENU button to enter the main menu, and then press the |◀◀ or ▶▶| button to select FM mode and press the MENU button to enter. The player will play FM under the preset station.
- B. From FM playing mode, you can switch between the saved channels by pressing the |◀◀ or ▶▶| button when the Preset appears after pressing the ▶ || button.

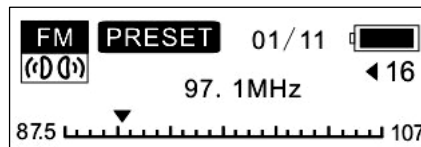

- C. From FM playing mode, you can press the |◀◀ or ▶▶| button to adjust the frequency manually, the frequency will increase or decrease by 0.1MHz; When reach the desired channel, you can press the MENU button to enter the FM main menu, and press the |◀◀ or ▶▶| button to select saving radio station, and then press the MENU button enter and the ▶ || button to save.

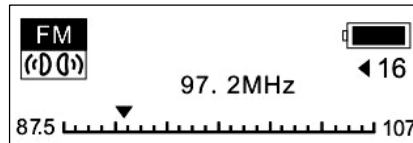

- D. From FM playing mode, you can press the VOL+ or VOL- button to adjust the volume.
- E. From FM playing mode, hold the ► || button for 3 seconds, the player will enter the power off mode.

FM Recording

From FM playing mode, press the A-B/ REC button 2 seconds to enter the FM recording mode, the FM music will be recorded in WAV format. You can press the ► || button to pause recording. You can press the A-B/ REC button to finish recording and save the file and listen under the Voice mode. The player will return to the FM Tuner screen.

FM recording

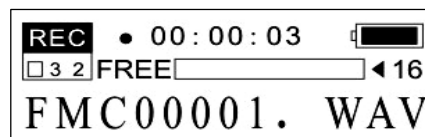

pause

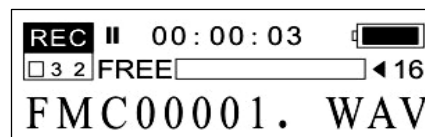

FM Setting

From FM playing mode, you can press the MENU to enter the function setting mode. You can press the | ◀ or ▶ | button to select: Play music, Play voice, Save station, Delete station, Auto Scan, Exit and then press the MENU button to enter the desired mode.

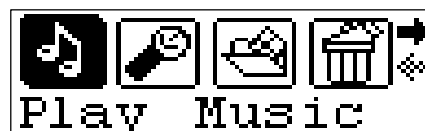

- A. Pay music: Press the MENU button to enter the FM main menu, and press the |◀◀ or ▶▶| button to select return to music playing, and then press the MENU button to exit the FM mode and enter the music playing standby mode.
- B. Play voice: Press the MENU button to enter the FM main menu, and press the |◀◀ or ▶▶| button to select return to voice playing, and then press the MENU button to exit the FM mode and enter the voice playing standby mode.
- C. Save station: Press the MENU button to enter the FM main menu, and then press the |◀◀ or ▶▶| button to select Save. Press the ▶ || button to confirm saving.

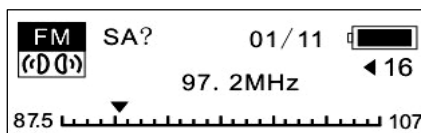

- D. Delete station: Press the MENU button to enter FM main menu, and press the |◀◀ or ▶▶| button to select Delete, and then press the ▶ || button to confirm delete.

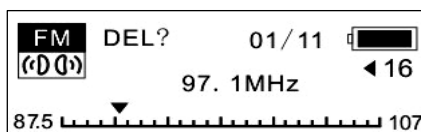

- E. Auto Scan: After entering this mode, the player will scan the radio station automatically and save.
- F. Exit: Return to FM playing mode.

4.4 Setting menu

From music mode or voice standby mode, you can press the MENU button to enter the main menu, and press the |◀ or ▶| button to select setting and press the MENU button to enter. The function setting includes: Equalizer, play mode, contrast, backlight, power set, record set, language and exit. You can press the MENU button to save the selected setting mode.

Settings	Equalizer	Normal, Pop, Rock, Classical, Jazz, Bass.
	Play mode	Normal, repeat one, repeat all, shuffle repeat
	Contrast	Press the ◀◀ or ▶▶ button to adjust
	Backlight	Always off, 5secs, 10secs, always on.
	Power set	Disable, 2MIN, 10MIN, 30MIN.
	Record set	8KHz, 11KHz, 16KHz, 22KHz,
	Language	This function depends on the software.
	Exit	Return to the previous menu.

4.5 Previous function

From music mode or voice standby mode, you can press the MENU button to enter the main menu, and press the |◀◀ or ▶▶| button to select the music preview function setting, and then press the MENU button to enter. During preview, it will play the initial 10 seconds of each music file and then skip to next. You can press the MENU button to exit.

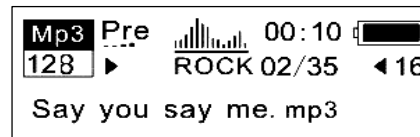

4.6 About

From music mode or voice standby mode, you can press the MENU button to enter the main menu, and press the |◀◀ or ▶▶| button to select about function, and then press the MENU button to enter. You can view the total memory and available memory.



4.7 Folder function

From music or voice standby mode, you can press the MENU button to enter the main menu, and press the |◀ or ▶| button to select folder function, and then press the MENU button to enter. You can press and hold the MENU button to browse the file, and press the |◀ or ▶| to select the desired one.



In the folder mode, press MENU to enter the PLAY or DELETE mode, press the |◀ or ▶| button to select. Press MENU to confirm. If you select the play, it will play the current song. If you select the delete, it will come into the delete mode. Re-press the |◀ or ▶| button to select the YES or NO. Press MENU to confirm and press ▶ || to exit.

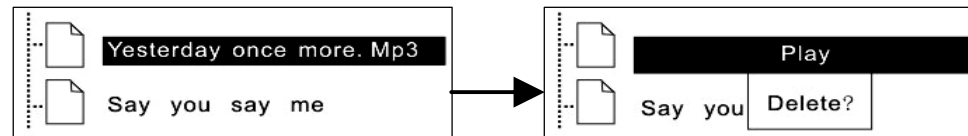

Note: You can't view the record folder and file under play music mode, which will only be available in play voice mode.

4.8 Exit

Return to music mode.

Note: From setting mode, you can press the ▶ || button to exit the setting mode quickly.

5. Other function

5.1 A-B play

From music or voice mode:

- (1) Press the A-B /REC button to select starting point A.
- (2) Press the A-B /REC button to select end point B, then it will repeat between A-B.
- (3) Press the A-B /REC button again to cancel setting and resume playing music or voice.

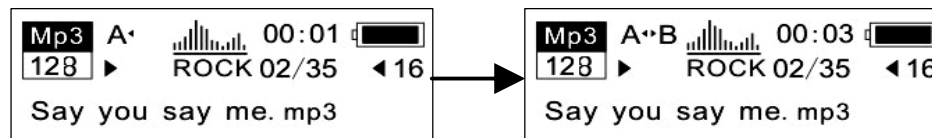

5.2 Lock

From music and voice standby/ play/ pause/ record mode, you can press the HOLD switch opposite the arrow to lock all the other buttons with a Lock icon on the LCD accordingly. If you want to use other buttons, please press the HOLD switch to the opposite direction of arrow.

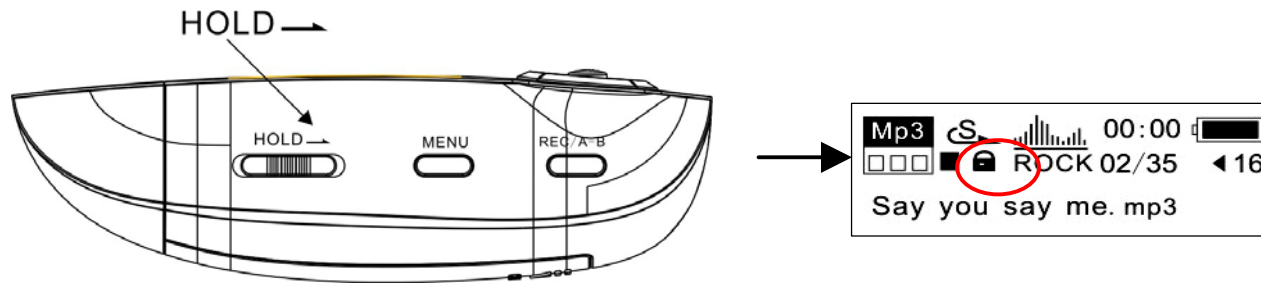

5.3 Lyric sync

This player supports lyric sync function.

Notice: The lyric name shall be the same as music with suffix of *. LRC and saved in the same directory, and only the lyrics with time indication can be displayed properly.

6.FAQ

Problem	Causes	Solution
No display after pressing the power button.	Without installing battery or battery is low.	Verify the battery is installed, change the battery.
Without sound when playing music.	<ol style="list-style-type: none"> 1. Volume is too low or without music in your player. 2. Battery is low. 3. Music or WMA file is corrupt. 	<ol style="list-style-type: none"> 1. Adjust the volume or download the file again. 2. Change the battery 3. Download the documents again.
Can 't download music file after connection.	<ol style="list-style-type: none"> 1. HOLD is on, the disk is write protected. 2. The USB is not connected to PC properly. 3. Storage directory is wrong. 	<ol style="list-style-type: none"> 1. Press the HOLD switch to the opposite direction. 2. Connect to the USB interface again and verify PC identified the removable disk. 3. Maximum 256 folders or files can be saved under root directory. If exceeded, please create another subdirectory under root directory before copy.

Can 't play the private compressed music files.	The music files currently are compressed with different compress rate and format, while this Player supports standard compressed music only, please do not adopts layer one or two compression.	Download the standard music files again.
No response after pressing button.	HOLD switch is on, buttons are locked.	Press the HOLD switch to the opposite direction.
Can't open the disk or prompt I/O error after connecting PC.	Caused by some improper operation.	Hold the V+button, and then connect USB cable, when there is a circle appears in the first box,then press firmware feature to format ,the upgrade will be ok until the circle change to be a tick.

7. Technical specifications

Bite rate:	8~320Kbps
Signal to noise ratio:	>85db
Dynamic scope:	>80(1KHZ)
Distortion:	<0.05% (REFERENCE LEVEL: 0dB (MUSIC) 1 mW, 4mW -52dB/-62dB (VOICE, REFERENCE FREQUENCY:1KHZ)
Output power:	5mW*2
USB port:	Standard USB2.0 high speed
Memory:	128MB/256MB/512MB/1GB/2GB
Dimensions of the device:	83.5*29.5*24mm
Weight of device:	<30g
Working condition:	Humidity<85%,-10~40°C
Storage condition:	Humidity <90%, normal temperature
Battery duration:	<12 hours, low power consumption
Record time	0.8hour(320KBPS,128MB);30HOURS (8KBPS,128MB)
Dynamic electricity	60mA
Static electricity	50mA
ID3 information display, blue backlight. In-phase lyric.	

X - MICRO
Plug & fly

www.x-micro.com