

Use and Care Manual

## Built-In Ovens



Models:

HBL8750, HBL8550, HBL8650



---

# Table of Contents

<b>About This Manual</b> .....	<b>1</b>
How This Manual is Organized .....	1
<b>Safety</b> .....	<b>2</b>
Important Safety Instructions .....	2
<b>Getting Started</b> .....	<b>6</b>
Parts and Accessories .....	6
Parts* .....	6
Accessories .....	7
Control* .....	10
Display Symbols* .....	11
Before Using the Oven for the First Time .....	12
<b>Operation</b> .....	<b>13</b>
About the Appliance .....	13
Basic Features .....	13
Turning the Oven On and Off .....	13
Setting the Clock .....	13
Setting the Date .....	14
Selecting the Upper or Lower Oven .....	16
Setting the Cooking Mode and Temperature .....	16
Info .....	16
Heating Time Limitation .....	16
Panel Lock .....	17
Timer .....	17
Fast Preheat .....	18
Special Features .....	18
Cook Time .....	19
End Time/Start Time .....	20
Recipe .....	22
Probe .....	25
Sabbath Mode .....	26
Setup .....	26
<b>Getting the Most Out of Your Appliance</b> .....	<b>28</b>
General Tips .....	28
Bake .....	29

- Convection Bake .....29
- True Convection .....31
- Pie .....32
- Pizza .....33
- Roast .....34
- Convection Roast .....34
- Broil .....35
- Convection Broil .....37
- Speed Convection .....38
- Proof .....39
- Warm .....39
- Dehydrate .....40

**Cleaning and Maintenance ..... 42**

- Cleaning .....42
- Self-Clean .....42
- Avoid These Cleaners .....43
- Cleaning Guide .....43
- Maintenance .....44
- Replacing an Oven Light .....44
- Removing the Oven Door .....46

**Service ..... 47**

- Before Calling Service .....47
- Troubleshooting Chart .....47
- Data Plate .....48
- STATEMENT OF LIMITED PRODUCT WARRANTY .....49

This Bosch Appliance is made by  
 BSH Home Appliances Corporation  
 5551 McFadden Ave.  
 Huntington Beach, CA 92649

**Questions?**

1-800-944-2904

[www.boschappliances.com](http://www.boschappliances.com)

**We look forward to hearing from you!**

---

# About This Manual

## How This Manual is Organized

You can get the most out of your new oven by reading this manual from beginning to end. This way you will systematically get to know your appliance and become familiar with its operation and features.

The manual consists of the following sections:

- The "*Safety*" section provides information on how to safely operate your oven.
- "*Getting Started*" introduces you to the oven components and features.
- The "*Operation*" section offers you step-by-step instructions on how to operate your oven.
- In "*Getting the Most Out of Your Appliance*" you can find a list of many common foods with the appropriate oven mode, temperature, rack position and bake time. This section also provides you with several bakeware and preparation tips.
- "*Cleaning and Maintenance*" provides you with information on how to clean and care for the various oven parts.
- The "*Service*" section includes your warranty and do-it-yourself troubleshooting tips.
- Pay special attention to the important safety instructions in the "*Safety*" section.

# Safety

	<b>Important Safety Instructions</b>
	READ AND SAVE THESE INSTRUCTIONS

	<b>WARNING:</b>
	When properly cared for, your new appliance has been designed to be safe and reliable. Read all instructions carefully before use. These precautions will reduce the risk of burns, electric shock, fire and injury to persons. When using kitchen appliances, basic safety precautions must be followed, including those in the following pages.

## Proper Installation and Maintenance

Have the installer show you the location of the circuit breaker or fuse. Mark it for easy reference.

This appliance must be properly installed and grounded by a qualified technician. Connect only to a properly grounded outlet. Refer to the Installation Instructions for details.

This appliance is intended for normal family household use only. It is not approved for outdoor use. See the Warranty. If you have any questions, contact the manufacturer.

Do not store or use corrosive chemicals, vapors, flammables or nonfood products in or near this appliance. It is specifically designed for use when heating or cooking food. The use of corrosive chemicals in heating or cleaning will damage the appliance and could result in injury.

Do not operate this appliance if it is not working properly, or if it has been damaged. Contact an authorized servicer.

Do not obstruct oven vents.

Do not repair or replace any part of the appliance unless specifically recommended in this manual. Refer all servicing to a factory authorized service center.

In the event of an error the display flashes and beeps continuously. If this happens during self-clean, disconnect appliance from the power supply and call a qualified technician.

In the event of an error the display flashes and beeps continuously. Disconnect appliance from the power supply and call a qualified technician.

## Fire Safety

Do not use aluminum foil or protective liners to line any part of the appliance, especially the oven bottom. Installing these liners may result in risk of electric shock or fire.

If materials inside an oven should ignite, keep door closed. Turn off the appliance, and disconnect the circuit at the circuit breaker box.



## Important Safety Instructions

READ AND SAVE THESE INSTRUCTIONS

Use this appliance only for its intended purpose as described in this manual. For example, never use the appliance for warming or heating the room. Never use the appliance for storage.

Always have a working smoke detector near the kitchen.

In the event that personal clothing or hair catches fire, drop and roll immediately to extinguish flames.

Smother flames from food fires other than grease fires with baking soda. Never use water on cooking fires.

Have an appropriate fire extinguisher available, nearby, highly visible and easily accessible near the oven.

### **WARNING:**

TO REDUCE THE RISK OF PERSONAL INJURY IN THE EVENT OF A GREASE FIRE, OBSERVE THE FOLLOWING:

- SMOTHER FLAMES with a close-fitting lid, cookie sheet, or metal tray, then turn off the burner. EXERCISE CAUTION TO PREVENT BURNS. If the flames do not go out immediately, EVACUATE AND CALL THE FIRE DEPARTMENT.
- NEVER PICK UP A FLAMING PAN—You may be burned.
- DO NOT USE WATER, including wet rags or towels—a violent steam explosion will result.
- Use an extinguisher ONLY if:
  - 1) You know you have a CLASS ABC extinguisher, and you already know how to operate it.
  - 2) The fire is small and contained in the area where it started.
  - 3) The fire department is being called.
  - 4) You can fight the fire with your back to an exit.

### **Burn Prevention**

DO NOT TOUCH HEATING ELEMENTS OR INTERIOR SURFACES OF OVEN — Heating elements may be hot even though they are dark in color. Interior surfaces of an oven become hot enough to cause burns. During and after use, do not touch, or let clothing, potholders, or other flammable materials contact heating elements or interior surfaces of oven until they have had sufficient time to cool. Other surfaces of the appliance may become hot enough to cause burns. Among these surfaces are oven vent openings, surfaces near these openings and oven doors.

Exercise caution when opening the appliance. Standing to the side, open the door slowly and slightly to let hot air and/or steam escape. Keep your face clear of the opening and make sure there are no children or pets near the unit. After the release of hot air and/or steam, proceed with your cooking. Keep doors shut unless necessary for cooking or cleaning purposes. Do not leave open doors unattended.

Do not heat or warm unopened food containers. Build-up of pressure may cause the container to burst and cause injury.



## Important Safety Instructions

READ AND SAVE THESE INSTRUCTIONS

Always place oven racks in desired location while oven is cool. If a rack must be moved while oven is hot, do not let potholder contact the heating elements.

Always use dry potholders. Moist or damp potholders on hot surfaces may result in burns from steam. Do not let potholder touch hot heating elements. Do not use a towel or other bulky cloth.

Secure all loose garments, etc. before beginning. Tie long hair so that it does not hang loose, and do not wear loose fitting clothing or hanging garments, such as ties, scarves, jewelry, or dangling sleeves.

### Child Safety

When children become old enough to use the appliance, it is the legal responsibility of the parents or legal guardians to ensure that they are instructed in safe operation of the appliance by qualified persons.

Do not allow anyone to climb, stand, lean, sit, or hang on any part of an appliance, especially a door, warming drawer or storage drawer. This can damage the appliance, and the unit may tip over, potentially causing severe injury.

Do not allow children to use this appliance unless closely supervised by an adult. Children and pets should not be left alone or unattended in the area where the appliance is in use. They should never be allowed to play in its vicinity, whether or not the appliance is in use.

### CAUTION:

Items of interest to children should not be stored in an appliance, in cabinets above an appliance or on the backsplash. Children climbing on an appliance to reach items could be seriously injured.

### Cleaning Safety

Do not clean the appliance while it is still hot. Some cleaners produce noxious fumes when applied to a hot surface. Wet cloths or sponges can cause burns from steam.

**IMPORTANT SAFETY NOTICE:** The California Safe Drinking and Toxic Enforcement Act requires the Governor of California to publish a list of substances known to the state to cause cancer, birth defects or other reproductive harm, and requires businesses to warn customers of potential exposure to such substances. The burning of gas cooking fuel and the elimination of soil during self-cleaning can generate small amounts of Carbon Monoxide. The fiberglass insulation in self-clean ovens gives off very small amounts of formaldehyde during the first several cleaning cycles. California lists formaldehyde as a potential cause of cancer. Carbon Monoxide is a potential cause of reproductive toxicity. Exposure to these substances can be minimized by:

1. Providing good ventilation when cooking with gas.
2. Providing good ventilation during and immediately after self-cleaning the oven.
3. Operating the unit according to the instructions in this manual.

When self-cleaning, confirm that the door locks and will not open. If the door does not lock, do not run Self-Clean. Contact service.



## Important Safety Instructions

READ AND SAVE THESE INSTRUCTIONS

Wipe out excessive spillage before self-cleaning the oven.

Birds have very sensitive respiratory systems . Keep pet birds out of the kitchen or other rooms where kitchen fumes could reach them. During self-clean, fumes are released that may be harmful to birds. Other kitchen fumes such as overheating margarines and cooking oils may also be harmful.

Keep oven free from grease build up.

### **Cookware Safety**

Do not place food directly on oven bottom.

Follow the manufacturer's directions when using cooking or roasting bags.

Do not clean parts or accessories in the self-clean oven.



# Getting Started

## Parts and Accessories

### Parts\*

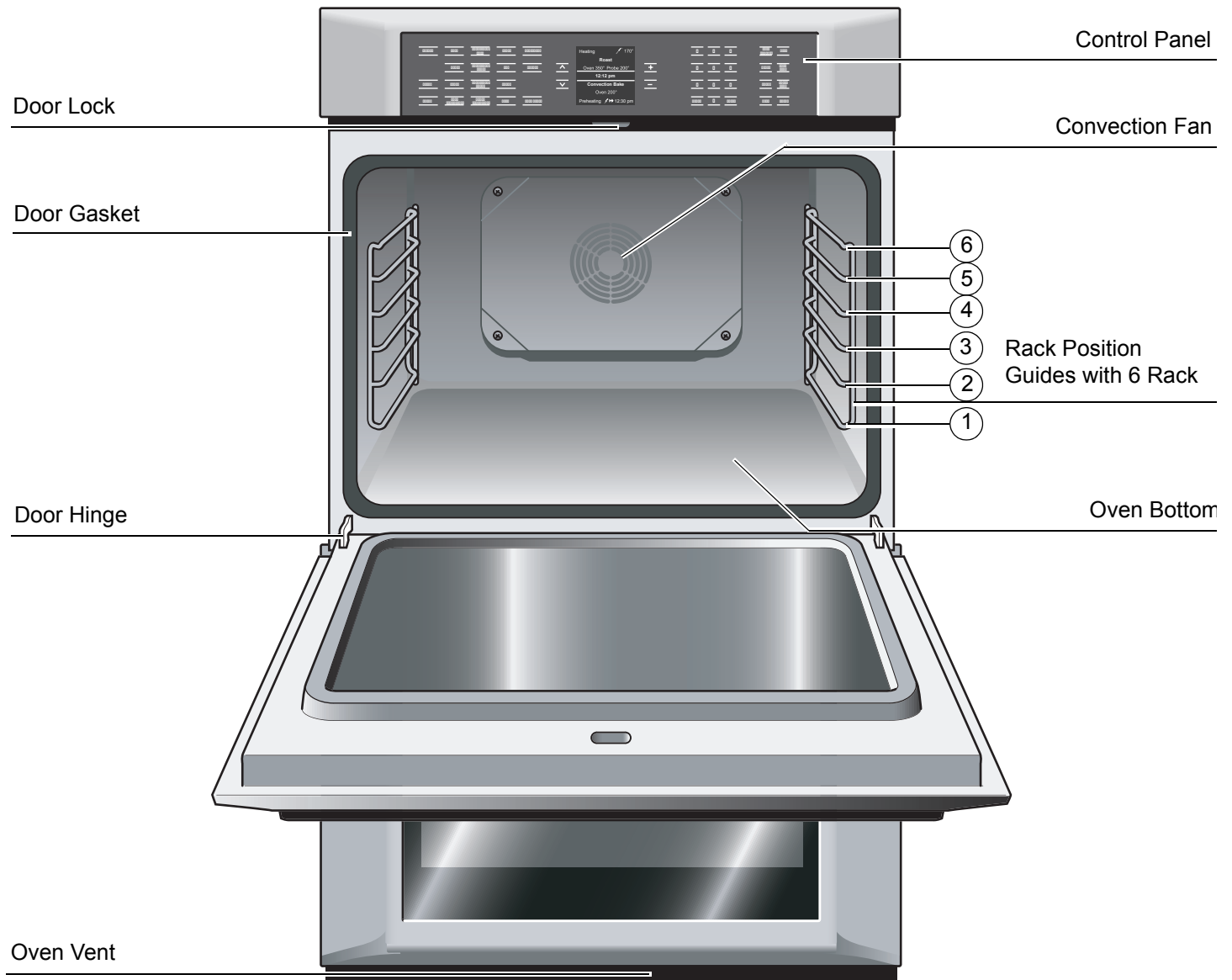

\* Picture shows double oven. Your appliance may vary slightly.

### Cooling Fan

The cooling fan runs during all cooking modes. The fan can be heard when it is running, and warm air may be felt as it is released from the oven vent. The fan may also run after the oven is off.

### Oven Vent

The oven vent is located at the bottom of the unit. Warm air may be released from the vent before, during and after cooking. It is normal to see steam escaping from

the vent, and condensation may collect in this area. This area may be warm when the oven is in use. Do not block the vent, since it is important for air circulation.

### Convection Fan

The convection fan operates during all convection modes. When the oven is operating in a convection mode, the fan turns off automatically when the door is opened. The convection fan may also run during self-clean.

### Oven Bottom

The oven bottom conceals the lower heating element. As a result the element is protected from damage and spills.

**Note:** Do not place food directly on the oven bottom.

	<b>WARNING:</b>
	Do not use aluminum foil or protective liners to line any part of the appliance, especially the oven bottom. Installation of these liners may result in a risk of electric shock or fire.

## Accessories

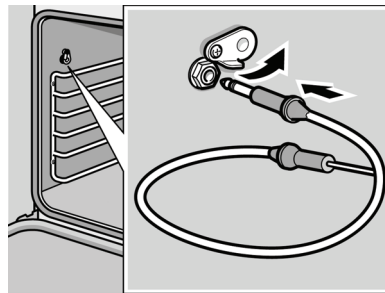

### Probe

The probe can be used to determine the internal doneness or the end temperature of many foods, especially meats and poultry.

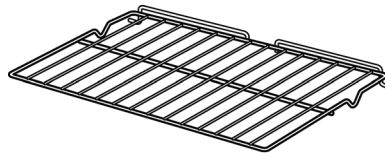

### Flat Rack

Do not clean in the self-clean oven.

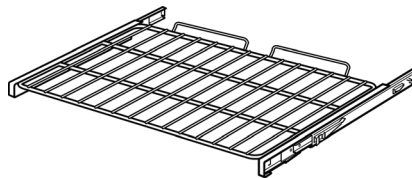

### Telescopic Rack

This rack allows for easier access when inserting or removing food. Do not clean in the self-clean oven.



### Broil Pan and Grid

Use for broiling and roasting. Do not clean in the self-clean oven.

## Inserting Rack

### Flat Rack

The rack is designed with a stop so it will stop before coming completely out of the oven and not tilt.



#### CAUTION:

To avoid burns, place oven racks in desired positions before turning oven on. Always use oven mitts when the oven is warm. If a rack must be moved while the oven is hot, do not let oven mitts contact hot heating elements.

#### Inserting Flat Rack into Oven:

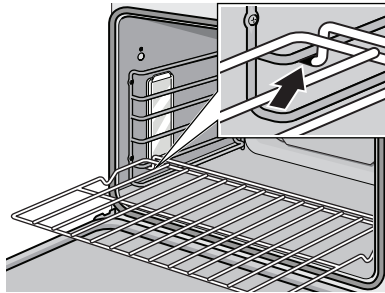

1. Grasp rack firmly on both sides.
2. Insert rack (see picture).
3. Tilt rack up to allow stop into rack guide.
4. Bring rack to a horizontal position and push the rest of the way in. Rack should be straight and flat, not crooked.

#### Removing Flat Rack from Oven:

1. Grasp rack firmly on both sides and pull rack toward you.
2. When the stop is reached, tilt rack up and pull the rest of the way out.

### Telescopic Rack

#### Inserting Telescopic Rack into Oven:

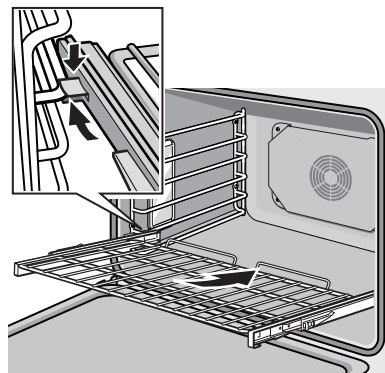

1. Hold the rack on a slight angle.

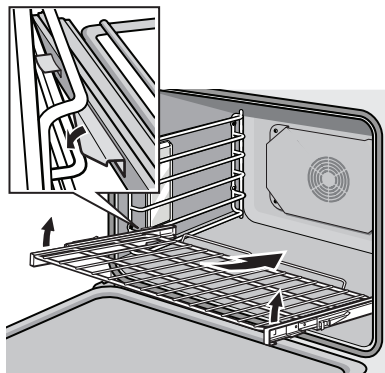

2. Engage the rear hooks in the accessory brackets.
3. Hold the rack straight.
4. Push the rack in until it is even with the front hooks.

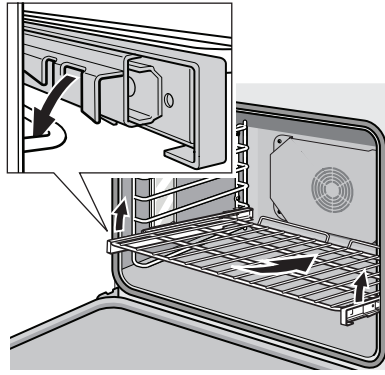





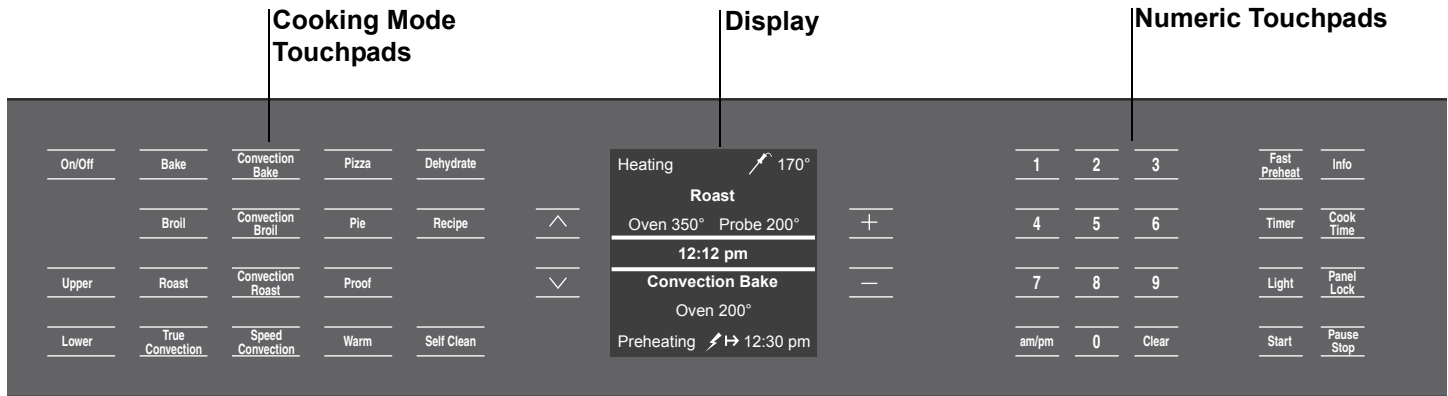

5. Lift the rack up.
  6. Push the rack in completely.
  7. Engage the rack's front hooks in the accessory brackets.
- This is very important to ensure that the rack is installed correctly (see the enlarged picture).

# Control\*



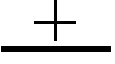
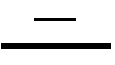
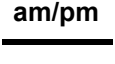
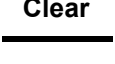
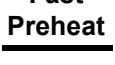



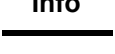

\*This is a double oven control panel. Your control panel may vary slightly.

**Touchpads:** You only have to press lightly on the touchpads to operate them. The touchpads will not work if you press several of them at once, such as when cleaning them.

	Turns the oven on and off.
	Moves the active field up.
	Moves the active field down.
	Touchpad for increasing setting values.
	Touchpad for decreasing setting values.
	Switches between am and pm in the clock setting.
	Clears the last number entered.
	Turns Fast Preheat on and off (not possible for all cooking modes).
	Sets and displays the timer. Beeps when time is up.
	Turns oven light on or off. Does not operate in self-clean mode.
	Starts the oven.
	Calls up information on the programmed cooking mode and rack position.

<b>Cook Time</b>	Sets and displays the cook time.
<b>Panel Lock</b>	Press and hold for four seconds to turn the panel lock on or off. Prevents the oven from being turned on or its settings from being changed accidentally.
<b>Pause Stop</b>	Press once to pause. Press twice to stop the oven and clear the programmed oven mode. Press and hold for two seconds to turn off the oven.
<b>Upper</b>	Switches to the upper oven in double oven models. Press before selecting or changing settings in the upper oven.
<b>Lower</b>	Switches to the lower oven in double oven models. Press before selecting or changing settings in the lower oven.

## Display Symbols\*

	<b>Timer</b> — Is displayed when Timer is active.		<b>Start Time Symbol</b> — Used when delaying the start of a timed oven mode. Shows the time of day that the oven mode will automatically start.
	<b>Fast Preheat Symbol</b> — Is displayed when Fast Preheat is active.		<b>Cook Time Symbol</b> — Used in conjunction with Cook Time mode. Shows the amount of time that the oven mode will run before turning off automatically.
	<b>Panel Lock Indicator</b> — Symbol is displayed when Panel Lock is turned on.		<b>Stop Time Symbol</b> — Used when delaying the start of a timed oven mode. Shows the time of day that the oven mode will automatically end.
	<b>Probe Symbol</b> — Appears when a probe is detected.		

\*All symbols are displayed on double ovens. Only the Fast Preheat Symbol, Panel Lock Indicator, and Probe Symbol appear on single ovens.

**Display:** Two lines appear in the display while settings are being made. The value that appears between the lines can be adjusted.

Upper	 02:10:23
Roast	
Oven 350°	
Probe 200°	
Press Start if ready	

## Before Using the Oven for the First Time

- Oven must be properly installed by a qualified technician before use.
- Remove all packing materials from inside and outside the oven.
- While cool, wipe with a clean, damp cloth and dry.
- There may be a slight odor during first uses; this is normal and will disappear.
- Optimum cooking results depend on proper cookware being used.
- Read and understand all safety precautions and Use and Care Manual information prior to operating.

---

# Operation

## About the Appliance

Your new oven combines premium cooking results and simple operation.

The oven design has been optimized to improve heat distribution in the oven cavity. The result is even browning, shorter cooking times and lower energy consumption.

Thanks to Self-Clean mode, hours of scrubbing into the darkest corners of the oven is a thing of the past. The oven burns off soil simply and easily. All that is left to do is to remove a few ashes from the oven when Self-Clean is done.

Clear labeling of the touch keys and knobs make operating the oven very easy. This manual includes all instructions for operating the oven.

Please call us if you ever have any questions. Our telephone number is located at the beginning of this manual. We welcome your comments and suggestions!

## Basic Features

### Turning the Oven On and Off

**To turn the oven on:**

Press **ON/OFF**.

The last oven mode selected and the default temperature appear in the display.

**To turn the oven off:**

Press **ON/OFF**.

The oven returns to standby mode.

**Double ovens:** To switch off only one oven, select the corresponding oven cavity using **UPPER** or **LOWER**. Next press **ON/OFF** within 10 seconds.

### Setting the Clock

This new oven includes time functions that require the current time to be set. It is therefore important to set the clock first.

The menu for setting the clock appears automatically after a power outage. In this case, proceed directly to step 2.



### To set the clock:

1. The oven must be turned off in order to access the “**Setup**” menu.  
Press **Info** for two seconds.

The “**Setup**” menu appears:

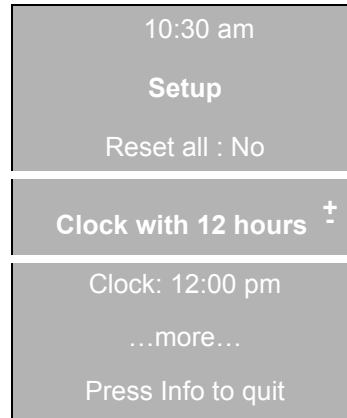

2. Use “+” and “-” to set a 12- or 24-hour clock display mode.
3. Press **V**.

“**Clock**” now appears between the two lines:

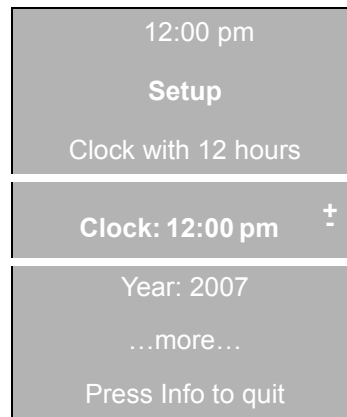

4. Use “+” and “-” or the numeric touchpads to set the time.

The desired time of day can be selected by pressing **am/pm**.

The clock is now set and starts as soon as a different menu item is selected using the arrows.

Press **Info** to confirm all entries and to exit the menu.

## Setting the Date

If the User Settings menu is already displayed, proceed with step 2.

### To set the date:

1. The oven must be turned off in order to access the “**Setup**” menu.  
Press and hold **Info** for two seconds to open the menu.

2. Use the arrows to select the **"Date"** menu item.

The year display now appears between the two lines:

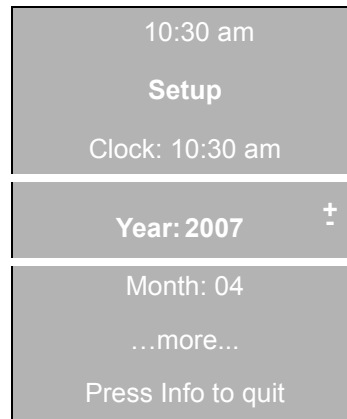

3. Use "+" and "-" or the numeric touchpads to set the year.

After two seconds, the month display will appear:

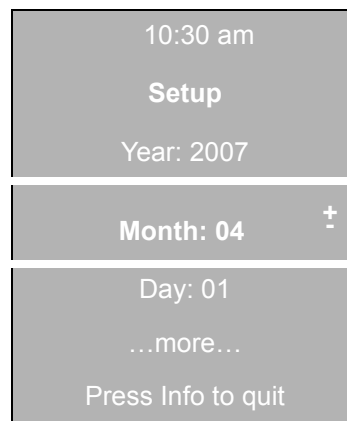

4. Use "+" and "-" or the numeric touchpads to set the month.

After two seconds, the day display will appear:

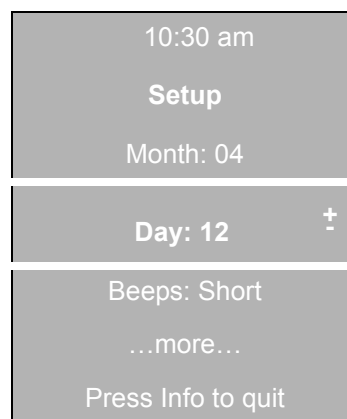

5. Use "+" and "-" or the numeric touchpads to set the day of the month.

The date is now set and starts as soon as a different menu item is selected using the arrows.

Press **Info** to confirm all entries and to exit the menu.

## Selecting the Upper or Lower Oven

To set a heating mode and temperature in a double oven, the corresponding oven has to be active. To select an oven, press **Upper** or **Lower**.

## Setting the Cooking Mode and Temperature

**To set the cooking mode and temperature:**

1. Turn oven on by pressing the **On/Off** touchpad.
2. Press the touchpad for the desired cooking mode.

The cooking mode and default temperature are displayed:

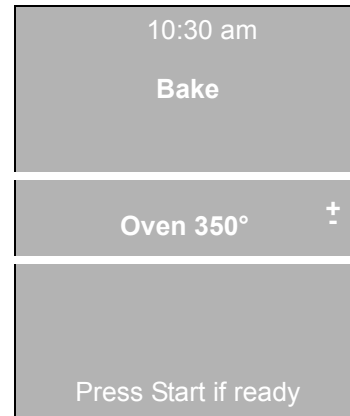

3. Use "+" and "-" or the numeric touchpads to set the temperature.
4. Press **Start**.

- Note:**
- The cooking mode can be changed at any time during operation. The temperature can be changed if it stands between the lines. Use "+" and "-" to set the new temperature.
  - For double oven models, the particular oven must be selected before the temperature can be changed. Press **Upper** or **Lower** to select an oven.

## Info

"**Info**" provides information on the current cooking mode and suggested rack positions.

Press **Info** repeatedly until the desired information appears in the display. After five seconds, the display automatically returns to the last screen before it was changed to the **Info** screen.

## Heating Time Limitation

The maximum heating time is limited. If you forget to turn off the oven, it turns off automatically after a set period of time (see table below), unless using Cook Time and Recipe.

The maximum time allowed for Dehydrate mode is 48 hours. The maximum time for Sabbath mode is 74 hours. For all other cooking modes, the maximum time allowed depends on the temperature:

Temperature in °F	Temperature in °C	Max. time allowed without activity
100–200	30–120	24 hours
201–550	121–300	12 hours

Heating stops until a setting is changed.

## Panel Lock

The panel lock is a child safety mechanism to prevent children from accidentally turning on the oven or changing an oven setting.

### Turning the panel lock on and off:

To turn the panel lock on, press and hold the **Panel Lock** key for four seconds. The Panel Lock symbol will appear in the display.

To turn the panel lock off, press and hold the **Panel Lock** key for four seconds. The message in the display will disappear.

When panel lock is activated, all keys are locked except for the following:

- **Cook Time:** Turns off beep for the end of cooking time.
- **Timer:** Turns off beep for the end of the timer.
- **On/Off:** Turns off oven.

## Timer

### To set the timer:

1. Press **Timer**.
2. Double oven models have two timers that can be set: use the arrows to select the preferred timer.

The timer is displayed between the two lines:

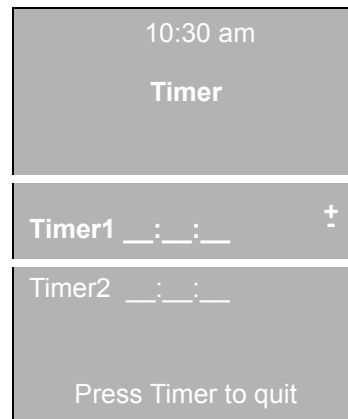

3. Use "+" and "-" or the numeric touchpads to set the timer.

4. Press **Timer**.

The timer starts.

A beep sounds when the timer ends. Press any touchpad to clear the beep sound and timer.

To change a running timer, press **Timer**, set a new time, and confirm by pressing **Timer** again.

To cancel a timer, set it to zero.

Press **Timer** twice to exit the timer menu.

- Note:**
- The maximum time the timer can be set is 24 hours.
  - The timer does not change when other settings are changed.
  - For double oven models, if both timers are running, only the timer that ends first is displayed. Press **Timer** to display both timers.

## Fast Preheat

Fast Preheat heats the oven quicker than standard preheat. It is available for Bake, Roast, True Convection, Convection Bake, Convection Roast, Pizza and Pie modes.

### To set Fast Preheat:

1. Set the cooking mode and temperature.
2. Press **Fast Preheat**.

The lightning icon ⚡ appears in the display:

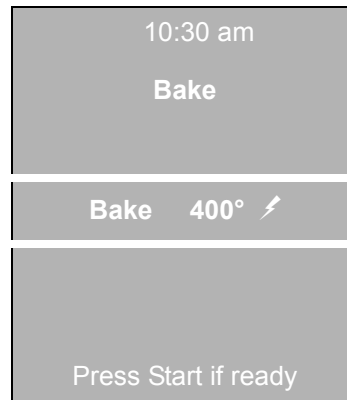

3. Press **Start**.

Fast Preheat can be turned off again by pressing **Fast Preheat**.

- Note:**
- The temperature must be set to at least 200 °F (100 °C) to use Fast Preheat.
  - Fast Preheat remains on even if the cooking mode is changed after Fast Preheat is started. If Fast Preheat is not available for the new mode, standard preheat is activated.

## Special Features

The special features provide you with additional conveniences when cooking.

Learn more about these special features in the following sections:

- Cook Time
- End/Start Time
- Recipe
- Probe
- Sabbath Mode

## Cook Time

Use the Cook Time feature to operate the cooking mode for a set period of time. The oven starts immediately and then turns off automatically when the set time is up.

### **CAUTION:**

To maintain food safety, do not leave food in the oven for more than one hour before or after cooking.

### **To set the Cook Time:**

1. Set the cooking mode and temperature.
2. Press **Cook Time**.

The "**Cook Time**" menu appears in the display with the default time (30 minutes):



3. Use "+" and "-" or the numeric touchpads to set the Cook Time.
4. Press **Start**.

The oven turns on. A beep sounds at the end of the programmed time. Open the oven door or press any touchpad to turn off the beep sound.

- Note:**
- To change the Cook Time after the oven has been started, press **Cook Time**. Use the "+" and "-" to set the new cooking time.
  - To cancel Cook Time, set it to zero.
  - Exiting the Cook Time menu is possible anytime by pressing **Cook Time**.

## End Time/Start Time

Use End Time or Start Time to delay the start of a timed mode. Enter the desired time for the mode to end or start. The oven calculates the proper start time or end time. It starts and stops automatically.

### To set the End Time:

1. Set the Cook Time as described in the previous section.
2. Press the **V** arrow.

The end time appears between the lines:

10:30 am	
<b>Cook Time</b>	
Cook time	00:30
<b>End time</b>	<b>11:00</b> $\pm$
Start time	10:30
Press Cook Time to quit	

3. Use “+” and “-” or the numeric touchpads to set the end time; for instance, 11:45 am:

10:30 am	
<b>Cook Time</b>	
Cook time	00:30
<b>End time</b>	<b>11:45</b> $\pm$
Start time	11:15
Press Cook Time to quit	

4. Press **Start**.

The oven enters delayed mode. When the programmed time is reached, the oven automatically turns on and then off again when done. A beep sounds at the end of the programmed time. Open the oven door or press any touchpad to turn off the beep sound.

**To set the Start Time:**

1. Set the Cook Time.
2. Press **^**.

The Start Time appears between the lines:



3. Use “+” and “-” or the numeric touchpads to set the start time; for instance, 11:00 am:



4. Press **Start**.

The oven enters delayed mode. When the programmed time is reached, the oven automatically turns on and then off again when done. A beep sounds at the end of the programmed time. Open the oven door or press any touchpad to turn off the beep sound.

Exiting the Cook Time menu is possible anytime by pressing **Cook Time**.



## Recipe

Recipe contains functions with pre-programmed settings. The cooking mode, temperature and cook time are automatically activated based on the items you choose in the menu. However, it is possible to change temperature and cooking time manually.

### CAUTION:

To maintain food safety, do not leave food in the oven for more than one hour before or after cooking.

### The following foods can be selected:

Category	Program	Rack Position	Weight (lbs)
Cookies*	One Rack	3	no weight
	Two Racks	1+4	no weight
	Three Racks	1+3+5	no weight
Cakes*	Sheet Cake	3	no weight
	Cupcakes	3	no weight
	Round Cake	3	no weight
Breads*	Biscuits	3	no weight
	Rolls	3	no weight
	Quick Breads	2	no weight
	Yeast Breads	2	no weight
Bar Cookies*	Brownies	3	no weight
	Lemon Bars	3	no weight
Pizza*	Self Rising	3	no weight
	Frozen Thin	3	no weight
Pie*	Frozen	3	no weight
	Fresh	2	no weight
Chicken	Whole	2	3.5–8.0
	Breast, bone-in	3	no weight
Turkey	Whole Unstuffed	1	10.0–25.0
	Breast	2	4.0–8.0
Meats	Rib Eye Medium Rare	2	3.0–5.5
	Rib Eye Medium	2	3.0–5.5
	Pork Loin	2	1.5–6.0
	Spiral Ham	2	6.0–10.0
Fish	Steaks 1 inch	3	no weight
	Whole	2	1.0–5.0
Casserole	Lasagna	3	no weight
	Macaroni and Cheese	3	no weight
	Green Bean Casserole	3	no weight
	Scalloped Potatoes	2	no weight

\*Insert food after preheat is finished.

- Note:**
- It is necessary to preheat for baked goods, pie, and pizza.
  - When using an automatic program, it is not necessary to preheat the oven when roasting meat or poultry.
  - If the food is not cooked to the desired degree of doneness, continue by using a normal heating mode (refer to the cooking charts).
  - It is possible to change the oven temperature and time for some programs.
  - Wrap spiral ham with aluminum foil prior to roasting.
  - Turkey may need to be covered after approximately 2 hours of roasting to prevent over browning.
  - After roasting beef and pork, let the meat stand covered with aluminum foil for 10 minutes in order to reach the final internal temperature.
  - The height of the rib eye roast should be 2 ½" to 3".
  - At the end of the automatic program check the internal temperature of the meat with a meat thermometer in order to ensure food safety.

**To set Recipe:**

1. Press **Recipe**.

The "**Recipe**" menu appears in the display with the category that was last selected; for instance, Cookies:

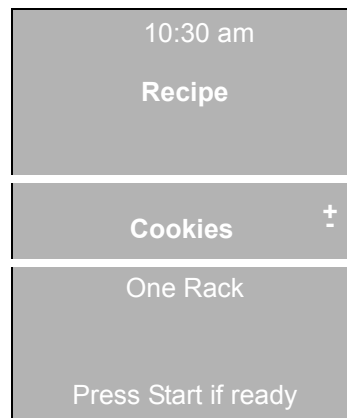

2. Use "+" and "-" to select the desired category; for instance, Turkey:

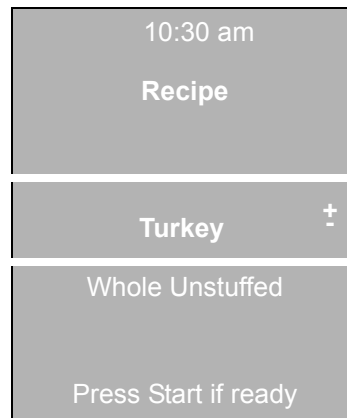

3. Press **V**.

The name of the first program of the selected category appears between the two lines:

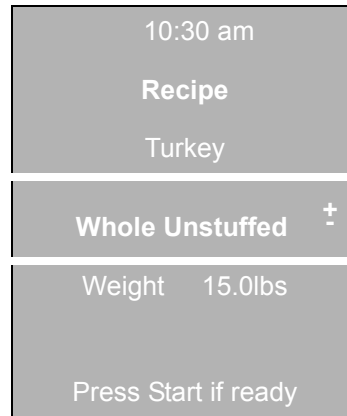

4. Use “+” and “-” to select the desired program; for instance, Breast.

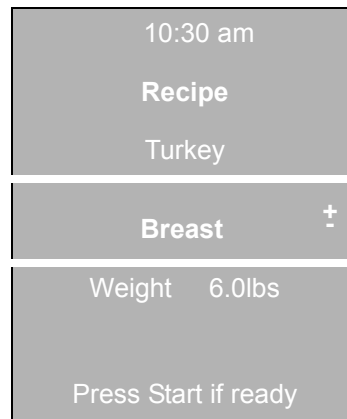

5. For programs that include weight, press **V** and use “+” and “-” to set the weight.

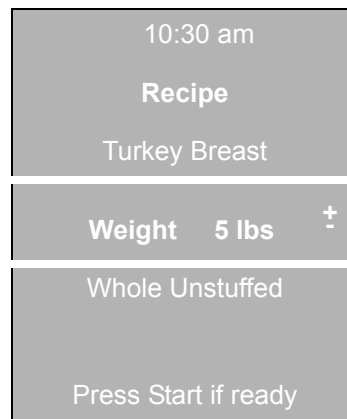

6. If desired, the cook time can be changed now by pressing **Cook Time**. Use “+” and “-” to set the new cooking time.
7. If desired, the temperature can be changed if it stands between the lines. Use “+” and “-” to set the new temperature.

**Note:** For meats and poultry, the temperature cannot be changed.

8. Press **Start**.

## Probe

The probe measures the internal temperature of the food. The probe is available for Bake, Roast and all convection cooking modes except Convection Broil.

### Inserting the probe:

Insert the tip of the probe in the middle and thickest part of the meat. Make sure the probe is not touching fat, bone, parts of the oven or pan.

### To use the probe:

1. Insert the probe into the meat as described above.
2. Connect the probe to the oven.
3. Set the cooking mode and temperature.

"Probe" appears in the display:

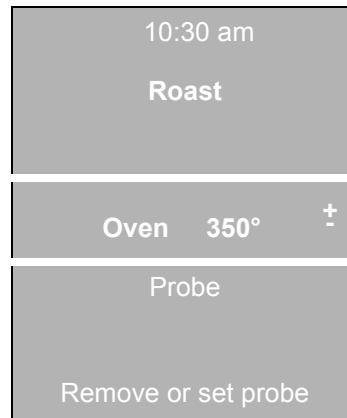

4. Press **V**.

"Probe" appears between the lines with the default temperature of 160 °F (70 °C):

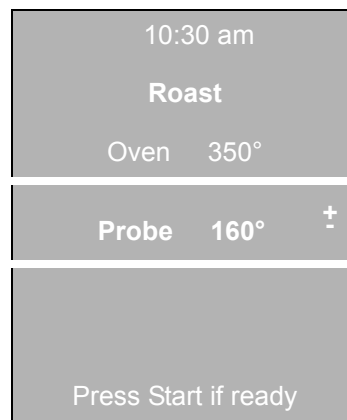

5. Use "+" and "-" or the numeric touchpads to set the probe temperature.
6. Press **Start**.

The oven turns off and a beep sounds once the internal temperature is reached. The probe icon disappears when the probe is removed.

- Note:**
- Probe is not available in Recipe mode or when a Cook Time has been set.
  - The probe temperature can always be changed when "Probe" appears between the lines in the display.
  - Do not store the probe in the oven.

- The range for the internal temperature is between 135°F and 200°F (60°C and 100°C).
- Always use the handle of the probe for inserting and removing.
- Always use a potholder to remove the probe since it becomes hot.
- For double oven models: the probe is only available for the upper oven.

## Sabbath Mode

The Sabbath Mode enables those of particular faiths to use their ovens on the Sabbath. Sabbath Mode must be activated in the Setup first (default setting = Yes).

### To set Sabbath Mode:

1. Press and hold **Bake** for four seconds.

The "**Sabbath Mode**" menu appears in the display:

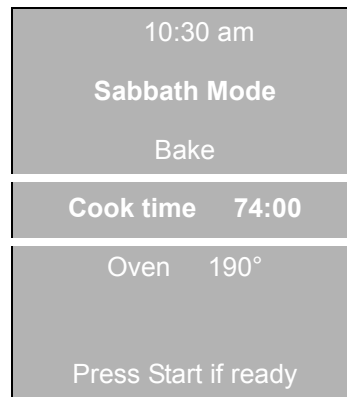

2. Use "+" and "-" or the numeric touchpads to set the desired time (24 to 74 hours).
3. Press **Start**.  
The oven starts.

- Note:**
- Press **Off** to cancel Sabbath Mode.
  - In double oven models: Sabbath Mode is only available for one oven at a time, and the other oven must be turned off.
  - The temperature in Sabbath Mode is 190 °F (85 °C).
  - You can set a period of time between 24 and 74 hours.

## Setup

The "**Setup**" menu is used to customize settings.

The oven must be turned off in order to access the "**Setup**" menu. Do the following to make changes:

1. Press **Info** for two seconds to access the "**Setup**" menu.
2. Use the arrows to select the desired menu item.
3. Use "+" and "-" to set the desired value.

The value is accepted as soon as a different menu item is selected using the arrows. Press **Info** to confirm all entries and to exit the menu.

The following can be set:

Menu item	Description	Default
Clock with	12-hour or 24-hour display mode.	12-hour
Clock	Sets the clock.	
Year Month Day	Sets the date.	
Beeps	Setting of beep length for finished cook process, timer and error: Short (10 sec), Medium (2 min), Long (5 min).	Short
Language	Language setting: English, Français, Español, Deutsch.	English
Temperature Unit	Fahrenheit (°F) or Celsius (°C).	°F
Weight in	lbs. or kg.	lbs
Sabbath	"Sabbath Mode" function: Yes or No.	Yes
Key Tones	Beeps each time a touchpad is pressed: Yes or No.	Yes
Oven Temperature Offset	Sets the temperature offset value. When an offset value is selected, the actual oven temperature is raised or lowered by this value. This feature is useful if food is consistently either too brown or too light.  The range for changing the offset is between +/- 35°F (+/- 19°C).  For double ovens: You can set the Oven Temperature Offset for each oven separately. To set either the upper or lower oven, select " <b>Up Offset</b> " or " <b>Lo. Offset</b> " from the menu.	0
Auto Conv	Activates or deactivates Auto Convection Conversion.	Yes
Reset All	Resets all settings to factory settings.	

---

# Getting the Most Out of Your Appliance

## General Tips

### Pan Placement

Baking results are better if pans are placed in the center of the oven. If baking more than one pan on a rack, allow at least 1" to 1 ½" of air space around the pan. When baking four cake layers at the same time, stagger pans on two racks so that one pan is not directly above the other.

### Preheating the Oven

- Place oven racks in desired position before heating the oven.
- Preheat the oven when using the Bake, Convection Bake, True Convection, Pizza, Pie, Broil, Convection Broil, and Warm modes.
- Preheat is not used for Speed Convection, Roast, Convection Roast, Proof, and Dehydrate modes.
- Allow oven to preheat while preparing recipe ingredients or food items.
- Setting a higher temperature does not shorten preheat time.
- Once oven is preheated, place food in the oven as quickly as possible to minimize the loss of heat and reduction of oven temperature.
- Use Fast Preheat to speed up preheating.

### For Best Results

- Use the cooking recommendations as a guide.
- Use the interior oven light to view the food through the oven window rather than opening the door frequently.
- Use the Timer to keep track of cooking times.
- Open the door as briefly as possible to avoid temperature reduction.

### Baking Pans and Dishes

- Glass baking dishes absorb heat. Therefore, reduce oven temperature 25 °F when baking in glass.
- Use pans that provide the desired browning. For tender, light, golden, brown crusts, use light, anodized or shiny metal bakeware.
- Dark, rough or dull pans (nonstick or anodized) will absorb heat and result in a browner, crisper crust. Some manufacturers recommend reducing the temperature 25 °F when using this type of pan. Follow manufacturers' recommendations.
- Insulated cookie sheets or bakeware may increase the length of cooking time.
- Do not set broil pans or any other heavy object on the open oven door.
- Do not keep the empty broil pan in the oven during cooking as this could change cooking performance. Store the broil pan outside the oven.

### High Altitude Baking

- When cooking at high altitude, recipes and cooking times will vary. For accurate information, write the Extension Service, Colorado State University, Fort Collins, Colorado 80521. There may be a cost for the guides. Specify which high altitude food preparation guide you prefer: general information, cakes, cookies, breads, etc.

### Condensation

- It is normal for certain amount of moisture to evaporate from the food during any cooking process. The amount depends on the moisture content of the food. The moisture may condense on any surface cooler than the inside of the oven, such as the control panel.

# Bake



**Bake** is cooking with dry, heated air. Both the upper and lower elements cycle to maintain the oven temperature.

The Bake mode can be used to prepare a variety of food items, from pastries to casseroles. Refer to recipe or package directions for oven temperature and baking time.

- Tips:**
- Preheat the oven if the recipe recommends it.
  - Baking time will vary with the size, shape and finish of the bakeware. Dark metal pans or nonstick coatings will cook faster with darker results. Insulated bakeware will lengthen the cook time for most foods.
  - For best results, bake food on a single rack with at least 1–1½" space between pans or dishes and oven walls.
  - Eliminate heat loss from the oven by using the window to periodically check food for doneness instead of opening the door.
  - If multiple racks are necessary, use a maximum of 2 racks. For cakes use rack positions 3 and 5. For cookies use rack positions 1 and 4. Stagger pans so that one is not directly above the other (see graphic below). You may also consider using a convection mode.

## 27" appliances:

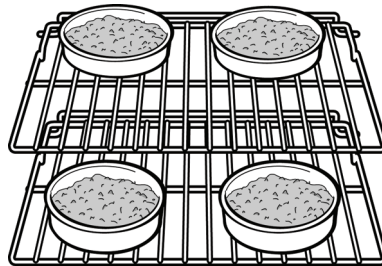

## 30" appliances:

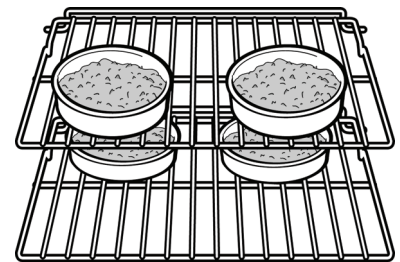

# Convection Bake



**Convection Bake** is similar to Bake. Heat comes from the upper and lower heating elements. The main difference in convection baking is that the heat is circulated throughout the oven by the convection fan.

The Convection Bake mode is well suited for cakes, bar cookies and breads to take advantage of the bottom heat, yielding a better crust on baked items. The benefits of Convection Bake include:

- Slight decrease in cook time.
- Higher volume (yeast items rise higher).



- Tips:**
- Place food in shallow, uncovered pans, such as cookie sheets without sides.
  - If baking more than one pan on a rack, allow at least 1" to 1½" of air space around the pan. Stagger pans so that one is not directly above the other (see graphic below).

**27" appliances:**

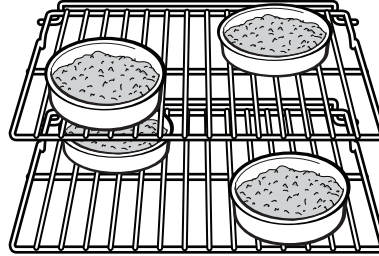

**30" appliances:**

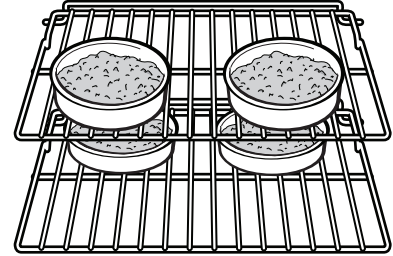

If you would like to convection bake cakes on 2 levels see the "True Convection Chart" for recommended rack positions.

## Auto Convection Conversion

Convection Bake and True Convection modes require a 25 °F reduction in temperature. Auto Convection Conversion reduces the temperature you enter automatically. Simply enter the package or recipe temperature when setting the mode. The control calculates the correct temperature and it is shown in the display.

The Auto Convection Conversion feature can be turned off to allow for manual temperature adjustments. See "Auto Convection Conversion" in the "Setup" section for details.

## Convection Bake Chart

Food Item	Rack Position	Temperature*	Time
<b>Cakes</b>			
Bundt Cake	2	325	45–65
Angel Food	1	325	40–50
Layers (8" or 9")	3	325	25–35
Rectangle (9x13)	3	325	30–37
<b>Bar Cookies</b>			
Lemon	3	325	30–40
Brownie	3	325	30–45
<b>Breads</b>			
Yeast Bread, loaf, 9x5	2	400	23–33
Quick Bread, loaf, 8x4	2	350	48–62

\*These temperatures have been reduced by 25 °F. Use these temperature if the Auto Convection Conversion feature is turned off.

# True Convection



**True Convection** cooks with heat from a third element behind the back wall of the oven. The heat is circulated throughout the oven by the convection fan.

True Convection is well suited for cooking individual serving-sized foods such as cookies and biscuits. It is also good for cooking on multiple racks (2 or 3) at the same time. Baking cookies is possible on 6 racks simultaneously. In this case, the baking time increases slightly. The benefits of True Convection include:

- Even browning.
- Time savings as a result of using multiple racks at one time.

- Tips**
- Reduce recipe temperature by 25 °F if Auto Convection Conversion is not activated. Refer to True Convection chart.
  - Place food in low-sided, uncovered pans such as cookie sheets without sides.
  - If baking more than one pan on a rack, allow at least 1" to 1½" of air space around the pan. Stagger pans so that one is not directly above the other (see graphic below).
  - For cakes use rack positions 2 and 5.

**27" appliances:**

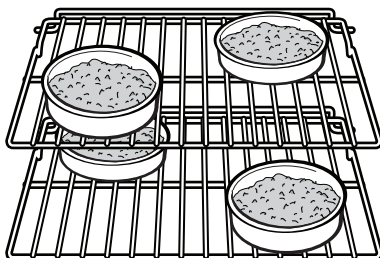

**30" appliances:**

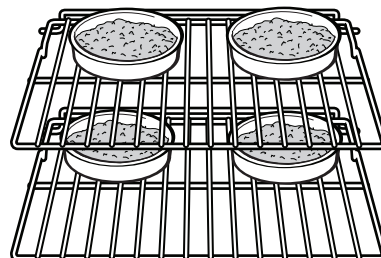

If you would like to convection bake cakes on 2 levels see the "*True Convection Chart*" for recommended rack positions.

## Auto Convection Conversion

True Convection and Convection Bake modes require a 25°F reduction in temperature. Auto Convection Conversion reduces the temperature you enter automatically. Simply enter the package or recipe temperature when setting the mode. The control calculates the correct temperature and it is shown in the display.

The Auto Convection Conversion feature can be turned off to allow for manual temperature adjustments. See "*Convection Conversion*" in the "*Setup*" section for details.

## True Convection Chart

Food Item	Rack Position			Temp.*	Time
	1 rack	2 racks	3 racks		
<b>Cakes</b>					
Cupcakes	4	2+5	1+3+5	325	17–27
Layers (8" or 9")	3	2+5		325	25–40
<b>Cookies</b>					
Sugar	3	2+5	1+3+5	350	6–10
Chocolate Chip	3	2+5	1+3+5	325	8–17
<b>Breads</b>					
Dinner Rolls	3	1+4	1+3+5	350	10–20
Biscuits	2	2+5	1+3+5	325	10–20
Muffins	3	2+5	1+3+5	400	14–25
<b>Cream Puffs</b>					
Fresh	3	2+5	1+3+5	400	23–33
*These temperatures have been reduced by 25 °F. Use these temperature if the Auto Convection Conversion feature is turned off.					

## Pie

	In the <b>Pie</b> mode, heat from the upper and lower element is circulated throughout the oven by the convection fan.
---	--

Use Pie to cook fresh or frozen pies.

- Tips:**
- Baking times may slightly decrease when using this mode. Check pies earlier.
  - To prevent over browning, the pie edge may need to be covered with foil or a pie ring.
  - Use bleached all purpose flour or pastry flour for crusts. Cake or bread flour may yield weak or tough crusts.
  - For tender crusts, substitute a small amount of vinegar for part of the liquid.
  - For a flaky crust, make sure that ingredients are cold during preparation.
  - To prevent dough from shrinking during cooking, place crust in pie pan, wrap in plastic wrap and rest in refrigerator for 30 minutes before adding filling. Note: dough can be stored like this for up to two days.
  - The convection fan cycles on and off when using pie mode.

## Pie Chart

Food	Rack	Temperature	Time
<b>2 Crust Fruit Pie</b> scratch frozen	2 3	375 375	45–60 75–85
<b>Custard Pie</b> scratch	2	425 350	12–15 35–48
<b>Pie Shell</b> scratch	2	475	8–12
<b>Meringue Topping Pie</b> scratch	2	350	12–18
<b>Nut Pie</b> scratch	2	350	45–60

## Pizza



In the **Pizza** mode, heat from the upper and lower elements is circulated throughout the oven by the convection fan.

Use the Pizza mode for fresh or frozen pizza.

- Tips:**
- For a crispy crust, place pizza directly on the rack.
  - For a softer crust, use a pizza pan.
  - When proofing dough, coat dough with olive oil and cover bowl tightly with plastic wrap to prevent crust formation.
  - Sprinkle cornmeal on the pizza pan to prevent sticking.
  - If using a pizza paddle, sprinkle the paddle liberally with cornmeal for ease in transferring the dough to the pan.
  - If par-baking handmade pizza dough, prick the dough with a fork before baking.
  - If using a pizza pan, choose a dark, perforated pan for a more crisp crust and a non-perforated pan for a softer crust.
  - Preheat baking stones while the oven is preheating.
  - Bake homemade pizzas on rack position 2 in center of the rack.
  - Follow manufacturer's directions for frozen pizza.
  - The convection fan cycles on and off when using pizza mode.

# Roast

	<b>Roast</b> uses both the upper and lower elements to maintain the oven temperature. Roasting uses more intense heat from the upper element than the lower element. This results in more browning of the exterior while the inside remains especially moist.
---	---

Roast is best suited for large cuts of meat and poultry.

- Tips:**
- Use a high-sided broil pan, or cover dish with a lid or foil.
  - Add liquids, such as water, juice, wine, bouillon or stock for flavor and moisture.
  - Roasting bags are suitable for use in this mode.
  - When roasting whole chicken or turkey, tuck wings behind back and loosely tie legs with kitchen string.

# Convection Roast

	<b>Convection Roast</b> uses heat from the top and bottom elements as well as heat circulated by the convection fan.
---	--

The Convection Roast mode is well suited for preparing tender cuts of meat and poultry.

The benefits of Convection Roast mode include:

- As much as 25% faster cooking than non-convection modes.
  - Rich, golden browning.
- Tips:**
- Use the same temperature as indicated in the recipe.
  - Check doneness early, since roasting time may decrease. Refer to Convection Roast chart for examples.
  - Do not cover meat or use cooking bags.
  - Use the broil pan and grid provided with the oven for roasting. A shallow, uncovered pan can also be used.
  - Use a meat thermometer to determine the internal temperature of the meat.
  - If the meat is browned to your liking, but is not yet done, a small strip of foil can be placed over the meat to prevent overbrowning.
  - Let meat stand covered with foil 10–15 minutes after removing it from the oven.
  - Refer to chart for recommended rack positions.

## Convection Roast Chart

Food Item	Rack Pos.	Weight	Oven Temp.	Time (min/lb)*	Internal Temp.
<b>Beef</b>					
Rib Eye Roast (boneless)					
Medium rare	2	3.0–5.5	325	27–31	145
Medium	2	3.0–5.5	325	30–38	160
Rump, eye, tip, sirloin (boneless)					
Medium rare	2	3.0–6.0	325	18–33	145
Medium	2	3.0–6.0	325	30–35	160
Tenderloin Roast (medium rare)	2	2.0–3.0	425	15–24	145
<b>Pork</b>					
Loin Roast (boneless or bone in)	2	1.5–2.9	350	19–36	160
Loin Roast (boneless or bone in)	2	3.0–6.0	350	14–23	160
Tenderloin	2	2.0–3.0	425	18–28	160
<b>Poultry</b>					
Chicken, whole	2	3.5–8.0	375	13–20	180
Turkey, unstuffed**	1	12.0–15.0	325	10–14	180
Turkey, unstuffed**	1	16.0–20.0	325	9–13	180
Turkey, unstuffed**	1	21.0–25.0	325	6–12	180
Turkey Breast	2	4.0–8.0	325	19–23	170
Cornish Hen	2	1.0–1.5	350	45–75 (total time)	180
<b>Lamb</b>					
Leg, bone-in					
Medium	2	4.0–6.0	325	30–35	170

\*Roasting times are approximate and may vary depending on shape of the meat.

\*\*Stuffed turkey requires additional roasting time. The minimum safe temperature for stuffing in poultry is 165 °F.

## Broil



**Broil** uses intense heat radiated from the upper element.

The Broil mode is best suited for cooking thin, tender cuts of meat (1" or less), poultry and fish. It can also be used to brown breads and casseroles. Always broil with the door closed. The benefits of broiling include:

- Fast and efficient cooking.
- Cooking without the addition of fats or liquids.

- Tips:**
- Preheat oven 3–4 minutes. Do not preheat for more than 5 minutes.
  - Steaks and chops should be at least ¾" thick.
  - Brush fish and poultry with butter or oil to prevent sticking.
  - Use the broil pan and grid included with the oven.
  - Do not cover the broil grid with foil. It is designed to drain fats and oils away from the cooking surface to prevent smoking and spattering.
  - Turn meats once during the recommended cook time (see Broil Chart for examples).
  - When top browning casseroles, use only metal or glass ceramic dishes such as Corningware®.
  - Never use heat-proof glass (Pyrex®); it cannot tolerate the high temperature.

## Broil Chart

Food Item	Rack Pos.	Broil Setting	Internal Temp.	Time side 1*	Time side 2*
<b>Beef</b>					
Steak, ¾" to 1"					
Medium Rare	6	3	145	5–7	4–6
Medium	5	3	160	8–9	5–7
Well	5	3	170	10–11	7–9
Hamburger, ¾" to 1"					
Medium	6	3	160	5–8	4–6
<b>Poultry</b>					
Chicken Thighs	3	1	180	14–15	12–13
<b>Pork</b>					
Pork Chops, 1"	4	2	160	8–10	8–9
Sausage - fresh	4	3	180	3–5	2–4
Ham Slice, ½"	5	3	160	4–5	3–4
<b>Seafood</b>					
Fish Filets, ¾" to 1"					
Buttered	3	1	145	11–15	Do not turn
<b>Lamb</b>					
Chops, 1"					
Medium Rare	4	3	145	4–6	4–5
Medium	4	3	160	5–7	5–6
Well	4	3	170	6–8	6–7

\*Broiling times are approximate and may vary slightly. Times are based on cooking with a preheated broil element.

# Convection Broil



**Convection Broil** is similar to Broil. It combines intense heat from the upper element with heat circulated by a convection fan.

Convection Broil mode is well suited for cooking thick, tender cuts of meat, poultry and fish. Convection Broil is not recommended for browning breads, casseroles and other foods. Always use convection broil with the door closed.

In addition to the benefits of standard broiling, convection broiling is faster.

- Tips:**
- Preheat oven 3–4 minutes. Do not preheat for more than 5 minutes.
  - Steaks and chops should be at least 1½" thick.
  - Use the broil pan and grid included with your oven.
  - Do not cover the broil grid with foil. It is designed to drain fats and oils away from the cooking surface to prevent smoking and spattering.
  - Turn meats once during the recommended cook time (see Convection Broil Chart for examples).
  - Never use heat-proof glass (Pyrex®); it cannot tolerate the high temperature.

## Convection Broil Chart

Food Item	Rack Pos.	Broil Setting	Internal Temp.	Time side 1*	Time side 2*
<b>Beef</b>					
Steak, 1½" or more					
Medium Rare	3	550	145	10–12	8–10
Medium	3	550	160	13–15	11–13
Well	3	550	170	15–17	13–15
Hamburger, 1" or more					
Medium	4	550	160	11–14	8–11
<b>Poultry</b>					
Chicken Breast, bone-in	3	450	170	18–22	17–20
<b>Pork</b>					
Chops, 1¼" or more	4	550	160	9–11	8–10
Sausage, fresh	4	550	180	5–7	3–5

\*Convection broiling times are approximate and may vary slightly. Times are based on cooking with a preheated broil element.



# Speed Convection

	<p><b>Speed Convection</b> uses all heating elements as well as the convection fan to evenly distribute heat throughout the oven cavity. The main difference between speed convection and other convection modes is that it does not require preheating.</p>
---	--

Speed Convection is well suited for frozen convenience foods such as fish sticks and chicken nuggets. The benefits of Speed Convection include:

- Decrease in cook time since **preheating is not necessary**.
- Crispy and evenly browned frozen foods.

- Tips:**
- Begin cooking all frozen convenience products in a cold, non-preheated oven. The food will still be done in package time.
  - Follow package instructions for time and temperature.
  - Flipping of food halfway through recommended cook time is not necessary.
  - Frozen foods that are sold in microwavable plastic containers should not be used in this mode.
  - Cook food items on rack position 3 unless directed otherwise by the product manufacturer.
  - Evenly space food items on pan.
  - For double ovens, only one cavity is available when using Speed Convection.

## Speed Convection Chart

Food Item	Rack Position	Temp.*	Time
<b>Frozen Food</b>			
Pizza Bites	3	450	9–11
Fish Sticks	3	475	10–14
Onion Rings	3	425	14–16
French Toast Sticks	3	450	7–11
Turnovers	3	400	18–26
Filled Pockets	3	350	27–31
Chicken Nuggets	3	400	9–13
Garlic Bread	3	450	7–11
Shoestring Fries	3	450	11–16

\*These temperatures have been reduced by 25 °F. Use these temperature if the Auto Convection Conversion feature is turned off.

# Proof



In **Proof**, the oven uses the upper and lower elements to maintain a low temperature to proof bread or other yeast doughs.

- Proofing is the rising of yeast dough.
- The Proof mode temperature range is 85 °F to 110 °F.
- The default temperature in the Proof mode is 100 °F.
- Loosely cover the bowl or pan and use any rack that accommodates the size of the container.
- Keep the door closed and use the oven light to check the rising of the dough.

# Warm



In **Warm**, the upper and lower elements maintain a low temperature in the oven cavity in order to keep food at serving temperature.

- Use the Warm mode to keep cooked foods hot until ready to serve.
- Warm mode temperatures are 150 °F–220 °F.
- The default temperature in the Warm mode is 170 °F.
- Foods that must be kept moist should be covered with a lid or aluminum foil.



## CAUTION:

When using Warm mode, follow these guidelines:

- Do not use the Warm mode to heat cold food.
- Be sure to maintain proper food temperature. The USDA recommends holding hot food at 140 °F or warmer.
- DO NOT warm food longer than one hour.

# Dehydrate



**Dehydrate** dries with heat from a third element behind the back wall of the oven. The heat is circulated throughout the oven by the convection fan.

Use Dehydrate to dry and/or preserve foods such as fruits, vegetables and herbs. This mode holds an optimum low temperature (100 °F – 160 °F) while circulating the heated air to slowly remove moisture. The oven stays on for 48 hours before shutting off automatically.

- Tips:**
- Dry most fruits and vegetables at 140 °F. Dry herbs at 100 °F (refer to the Dehydrate Chart for examples).
  - Drying times vary depending on the moisture and sugar content of the food, the size of the pieces, the amount being dried and the humidity in the air. Check food at the minimum drying time.
  - Multiple drying racks (not included) can be used simultaneously.
  - Treat fruits with antioxidants to avoid discoloration.
  - Consult a food preservation book, county Cooperative Extension Office or library for additional information.

## Dehydrate Chart

Food Item	Preparation	Approx. drying time (hrs)	Test for doneness
<b>Fruit</b>			
Apples	Dipped in ¼ cup lemon juice and 2 cups water, ¼" slices.	11–15	Slightly pliable.
Bananas	Dipped in ¼ cup lemon juice and 2 cups water, ¼" slices.	11–15	Slightly pliable.
Cherries	Wash and towel dry. For fresh cherries, remove pits.	10–15	Pliable leathery, chewy.
Orange peels	Orange part of skin thinly peeled from oranges.	2–4	Dry and brittle.
Orange slices	¼" slices of orange.	12–16	Skins are dry and brittle, fruit is slightly moist.
Pineapple rings canned	Towel dried.	9–13	Soft and pliable.
fresh	Towel dried.	8–12	Soft and pliable.
Strawberries	Wash and towel dry. Sliced ½" thick, skin (outside) down on rack.	12–17	Dry and brittle.

Food Item	Preparation	Approx. drying time (hrs)	Test for doneness
<b>Vegetables</b>			
Peppers	Wash and towel dry. Remove membrane of peppers, coarsely chopped about 1" pieces.	15–17	Leathery with no moisture inside.
Mushrooms	Wash and towel dry. Cut off stem end. Cut into 1/8" slices.	7–12	Tough and leathery, dry.
Tomatoes	Wash and towel dry. Cut thin slices, 1/8" thick, drain well.	15–20	Dry, brick red color.
<b>Herbs</b>			
Oregano, Sage, Parsley, Thyme, Fennel	Rinse and dry with paper towel.	Dry at 100 °F 4–6 hours.	Crisp and brittle.
Basil	Use basil leaves 3 to 4 inches from the top. Spray with water, shake off moisture and pat dry.	Dry at 100 °F 4–6 hours.	Crisp and brittle.

# Cleaning and Maintenance

## Cleaning

### Self-Clean

During Self-Clean, the oven is heated to a very high temperature. Soil is burned off at this temperature.

**IMPORTANT:**

Wipe out excessive spillage before self-cleaning the oven.

**IMPORTANT:**

Do not clean parts or accessories in the Self-Clean oven.

**To set the Self-Clean mode:**

1. Remove all accessories and racks from the oven.
2. Press **Self Clean**.

The "**Self Clean**" menu appears in the display:

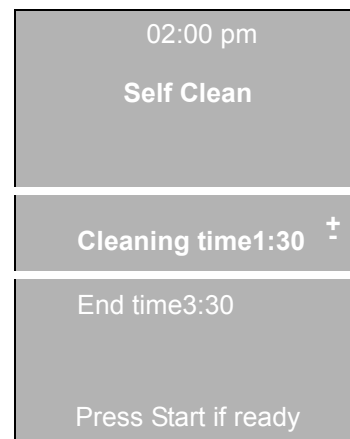

3. Use "+" and "-" or the numeric touchpads to set the desired cleaning time (1:30 to 2:30 hrs). Select 2:30 hours for a heavily soiled oven. Select 1:30 hours for a lightly soiled oven.
4. To change the end time, press  $\nabla$  and use "+" and "-" or the numeric touchpads to set the new end time.
5. Press **Start**.

Self-Clean starts, and the oven starts to lock the door. After a few seconds, the door is locked and "**Door Locked**" appears in the display. The oven can be opened again only after the oven has cooled and "**Self Clean**" disappears from the display.

Press **On/Off** to cancel Self-Clean.

Wipe remaining ash from the oven using a moist cloth.

- Note:**
- In double oven models, Self-Clean is only available for one oven at a time, and the other oven must be turned off.
  - The oven light cannot be turned on during self-cleaning.

- The special heat-resistant enamel and the polished components in the oven can become discolored over time. This is normal and does not affect operation. Do not use scouring pads or abrasive cleaners to treat discolorations.

## Avoid These Cleaners

Do not use commercial oven cleaners such as Easy Off®. They may damage the oven finish or parts.

Never use scouring pads or abrasive cleaners.

## Cleaning Guide

Part	Recommendations
Flat Rack	<p>Wash with hot soapy water. Rinse thoroughly and dry, or gently rub with cleansing powder or soap-filled pads as directed. DO NOT clean the rack in the self-cleaning oven.</p> <p>If flat racks are cleaned in the oven during the self clean mode, they will lose their shiny finish and may not glide smoothly. If this happens wipe the rack edges with a small amount of vegetable oil. Then wipe off excess.</p>
Telescopic Rack	<p>Wash with hot soapy water. Rinse thoroughly and dry, or gently rub with cleansing powder or soap-filled pads as directed. Avoid getting cleansing powder in the telescopic slides. Relubrication may become necessary. Use only high-temperature food-grade lubricants to re-lubricate slides.</p> <p>DO NOT clean the rack in the self-cleaning oven.</p>
Broil Pan and Grid	<p>Wash with hot soapy water. Rinse thoroughly and dry, or gently rub with cleansing powder or soap-filled pads as directed. DO NOT clean broil pan and grid in the self-cleaning oven.</p>
Fiberglass Gasket	<p>DO NOT CLEAN GASKET.</p>
Glass	<p>Wash with soap and water or glass cleaner. Use Fantastik® or Formula 409® to remove grease splatters and stubborn stains.</p>
Painted Surfaces	<p>Clean with hot soapy water or apply Fantastik® or Formula 409® to a clean sponge or paper towel and wipe clean. Avoid using powder cleaning agents, steel wool pads and oven cleaners.</p>
Porcelain Surfaces	<p>Immediately wipe up acid spills like fruit juice, milk and tomatoes with a dry cloth. Do not use a moistened sponge/cloth on hot porcelain. When cool, clean with hot soapy water or apply Bon-Ami® or Soft Scrub® to a damp sponge. Rinse and dry. For stubborn stains, use soap-filled pads. It is normal for porcelain to show fine lines with age due to exposure to heat and food soil.</p>

Part	Recommendations
Stainless Steel Surfaces	Always wipe or rub in the direction of the grain. Clean with a soapy sponge, then rinse and dry, or wipe with Fantastik® or Formula 409® sprayed on a paper towel. Protect and polish with Stainless Steel Magic® and a soft cloth. Remove water spots with a cloth dampened with white vinegar. Use Bar Keeper's Friend® to remove heat discoloration.
Plastic & Controls	When cool, clean with soapy water, rinse and dry.
Probe	Wipe with soapy water. Do not submerge. Do not wash in the dishwasher.
Printed areas (words and numbers)	Do not use abrasive cleansers.

## Maintenance

### Replacing an Oven Light



#### CAUTION:

- Make sure the appliance and lights are cool and power to the appliance has been turned off before replacing the light bulb(s). Failure to do so could result in electrical shock or burns.
- The lenses must be in place when using the appliance.
- The lenses serve to protect the light bulb from breaking.
- The lenses are made of glass. Handle carefully to avoid breaking. Broken glass could cause an injury.
- Light socket is live when door is open.

Use only 10 Watt, 12 Volt bi-pin halogen light bulbs. These bulbs can be purchased through retail stores.

Use a clean, dry cloth to handle halogen light bulbs. This will increase the life of the bulb.

#### To replace the halogen bulb on the oven ceiling:

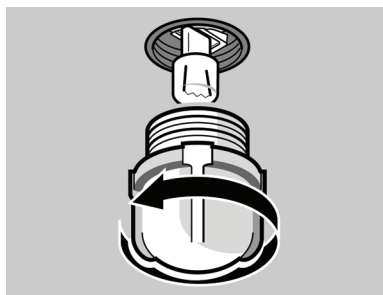

1. Turn off power to the oven at the main power supply (fuse or breaker box).
2. Remove the glass cover by unscrewing it.

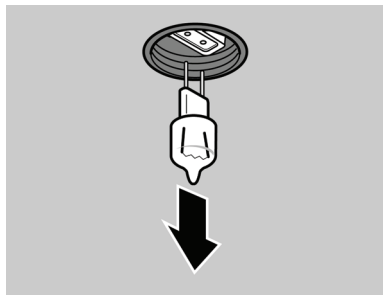

3. Remove the halogen bulb and replace. Grasp the new bulb with a clean, dry cloth.
4. Screw the glass cover back on.
5. Turn power back on at the main power supply (fuse or breaker box).

**To replace the halogen bulb on the oven sidewall:**

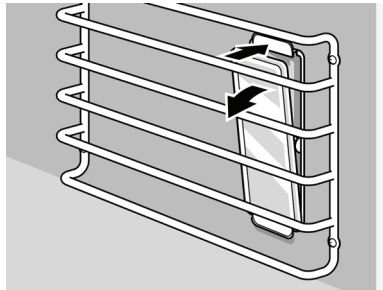

1. Turn off power to the oven at the main power supply (fuse or breaker box).
2. Push the top mounting clip back and remove the glass cover.

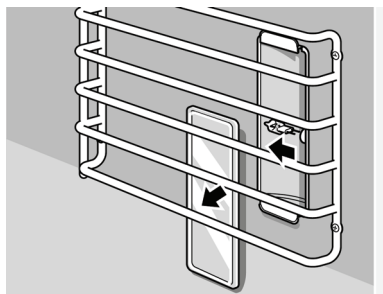

3. Pull the halogen bulb from its socket.

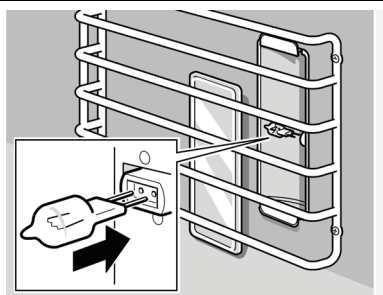

4. Replace the halogen bulb. Grasp the new bulb with a clean, dry cloth.

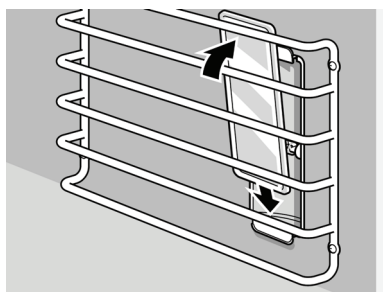

5. Put the glass cover back on by inserting it into the lower mounting clip and pressing upward until it locks into place.
6. Turn power back on at the main power supply (fuse or breaker box).



## Removing the Oven Door



### CAUTION:

When removing the door:

- Make sure oven is cool and power to the oven has been turned off before removing the door. Failure to do so could result in electrical shock or burns.
- The oven door is heavy and fragile. Use both hands to remove the oven door. The door front is glass. Handle carefully to avoid breaking.
- Grasp only the sides of the oven door. Do not grasp the handle as it may swing in your hand and cause damage or injury.
- Failure to grasp the oven door firmly and properly could result in personal injury or product damage.
- To avoid injury from hinge bracket snapping closed, be sure that both levers are securely in place before removing the door. Also, do not force door open or closed—the hinge could be damaged and injury could result.

### To remove the oven door:

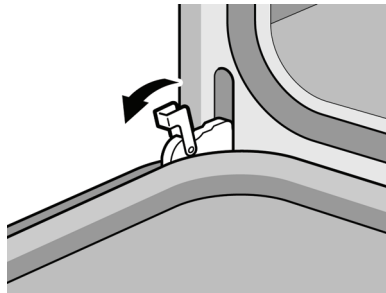

1. Be sure to read the above WARNING before attempting to remove the door.
2. Open the door completely.
3. Flip levers on hinges toward you.

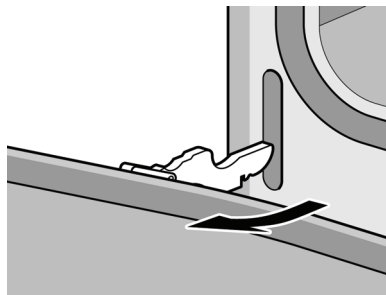

4. Close door carefully until it stops. It will be about half way closed.
5. Holding the door firmly on both sides using both hands, pull the door up and out of the hinge slots. Hold firmly; the door is heavy.
6. Place the door in a convenient and stable location for cleaning.

### To replace the oven door:



1. Holding the door firmly in both hands, place hinges in hinge slots.
2. Open door all the way to expose hinges and slots.
3. Push lever down and away from you until flush with the bracket.
4. Close and open door slowly to be sure it is correctly and securely in place. Door must be straight, not crooked.

# Service

## Before Calling Service

### Troubleshooting Chart

Oven Problem	Possible Causes and Suggested Solutions
Oven door is locked and will not open, even after cooling.	Turn the oven off at the circuit breaker and wait five minutes. Turn breaker back on. The oven should reset itself and will be operable.
Oven is not heating.	Check circuit breaker or fuse box to your house. Make sure there is proper electrical power to the oven. Be sure oven temperature has been selected.
Oven is not cooking evenly.	Refer to cooking charts for recommended rack position. Check " <i>Getting the Most Out of Your Appliance</i> " for tips and suggestions.
Baking results are not as expected.	Refer to cooking charts for recommended rack position. Check " <i>Getting the Most Out of Your Appliance</i> " for tips and suggestions. Adjust oven calibration if necessary. See " <i>Oven Temperature Offset</i> " under " <i>Setup</i> ".
Food takes longer to cook than expected.	The oven is carefully calibrated to provide accurate results. However, the temperature can be offset if food is consistently too brown or too light. See " <i>Oven Temperature Offset</i> " under " <i>Setup</i> ".
Food is overcooked.	The oven is carefully calibrated to provide accurate results. However, the temperature can be offset if food is consistently too brown or too light. See " <i>Oven Temperature Offset</i> " under " <i>Setup</i> ".
Convection Bake/True Convection results are not as expected.	The oven temperature must be manually reduced by 25 °F, unless Automatic Convection Conversion is activated. Refer to cooking charts and tips for rack positions, cooking times and pan selection. Adjust oven calibration if necessary. See " <i>Oven Temperature Offset</i> " under " <i>Setup</i> ".
Oven light is not working properly.	Replace or reinsert the light bulb if loose or defective. Touching the bulb with fingers may cause the bulb to burn out.
Oven light does not turn off.	Check for obstruction in oven door. Check to see if hinge is bent.
Oven is not self-cleaning properly.	Allow the oven to cool before running self-clean. Always wipe out loose soils or heavy spillovers before running self-clean. If oven is badly soiled, set oven for the maximum self-clean time.
Clock and timer are not working properly.	Make sure there is electrical power to oven.
"E" and a number appears in display and control beeps.	This is a fault code. Follow the instructions in the display. If the code remains or there are no instructions in the display, press <b>INFO</b> to display more information (if applicable) and to turn off the beep. If the code is still displayed, write down the fault code number, turn off the oven, and call Service.
With a new oven there is a strong odor when oven is turned on.	This is normal with a new oven and will disappear after a few uses. Operating the self-clean cycle also "burns-off" the smell more quickly.
Control does not react when a key is touched.	Be sure that surface is clean and dry. Touch the center of the touch key. Use the flat part of your finger.
Fan is running during modes that do not use convection	On some models, the convection fan runs while the oven is preheating. This is normal.

Oven Problem	Possible Causes and Suggested Solutions
Warm air or steam escapes from oven vent.	It is normal to see or feel steam or warm air escaping from the oven vent. Do not block the vent.
Cooling fan runs even when the oven is turned off.	This is normal. The cooling fan will continue to run, even after the oven has been turned off, until the oven has cooled sufficiently.

## Data Plate

The data plate shows the model and serial number. Refer to the data plate on the appliance when requesting service. The data plate is located on the underside of the control panel:

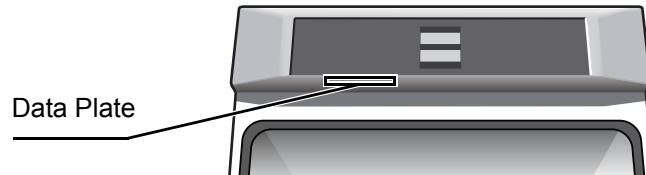

## How to Obtain Service or Parts

To reach a service representative, see the contact information at the front of the manual. Please be prepared with the information printed on your product data plate when calling.

# STATEMENT OF LIMITED PRODUCT WARRANTY

## What this Warranty Covers & Who it Applies to

The limited warranty provided by BSH Home Appliances Bosch in this Statement of Limited Product Warranty applies only to the Bosch appliance sold to you, the first using purchaser, provided that the Product was purchased:

- For your normal, household (non-commercial) use, and has in fact at all times only been used for normal household purposes.
- New at retail (not a display, "as is", or previously returned model), and not for resale, or commercial use.
- Within the United States or Canada, and has at all times remained within the country of original purchase.

The warranties stated herein apply only to the first purchaser of the Product and are not transferable.

Please make sure to return your registration card; while not necessary to effectuate warranty coverage, it is the best way for Bosch to notify you in the unlikely event of a safety notice or product recall.

## How Long the Warranty Lasts

Bosch warrants that the Product is free from defects in materials and workmanship for a period of twelve (12) months from the date of purchase. The foregoing timeline begins to run upon the date of purchase, and shall not be stalled, tolled, extended, or suspended, for any reason whatsoever.

## Repair/Replace as Your Exclusive Remedy

During this warranty period, Bosch or one of its authorized service providers will repair your Product without charge to you (subject to certain limitations stated herein) if your Product proves to have been manufactured with a defect in materials or workmanship. If reasonable attempts to repair the Product have been made without success, then Bosch will replace your Product (upgraded models may be available to you, in Bosch's sole discretion, for an additional charge). All removed parts and components shall become the property of Bosch at its sole option. All replaced and/or repaired parts shall assume the identity of the original part for purposes of this warranty and this warranty shall not be extended with respect to such parts. Bosch's sole liability and responsibility hereunder is to repair manufacturer-defective Product only, using a Bosch-authorized service provider during normal business hours. For safety and property damage concerns, Bosch highly recommends that you do not attempt to repair the Product yourself, or use an un-authorized servicer; Bosch will have no responsibility or liability for repairs or work performed by a non-authorized servicer. If you choose to have someone other than an authorized service provider work on your Product, THIS WARRANTY WILL AUTOMATICALLY BECOME NULL AND VOID. Authorized service providers are those persons or companies that have been specially trained on Bosch products, and who possess, in Bosch's opinion, a superior reputation for customer service and technical ability (note that they are independent entities and are not agents, partners, affiliates or representatives of Bosch). Notwithstanding the foregoing, Bosch will not incur any liability, or have responsibility, for the Product if it is located in a remote area (more than 100 miles from an authorized service provider) or is reasonably inaccessible, hazardous, threatening, or treacherous locale, surroundings, or environment; in any such event, if you request, Bosch would still pay for labor and parts and ship the parts to the nearest authorized service provider, but you would still be fully liable and responsible for any travel time or other special charges by the service company, assuming they agree to make the service call.

## Out of Warranty Product

Bosch is under no obligation, at law or otherwise, to provide you with any concessions, including repairs, pro-rates, or Product replacement, once this warranty has expired.

## Warranty Exclusions

The warranty coverage described herein excludes all defects or damage that are not the direct fault of Bosch, including without limitation, one or more of the following:

- Use of the Product in anything other than its normal, customary and intended manner (including without limitation, any form of commercial use, use or storage of an indoor product outdoors, use of the Product in conjunction with air or water-going vessels).
- Any party's willful misconduct, negligence, misuse, abuse, accidents, neglect, improper operation, failure to maintain, improper or negligent installation, tampering, failure to follow operating instructions, mishandling, unauthorized service (including self-performed "fixing" or exploration of the appliance's internal workings).
- Adjustment, alteration or modification of any kind.
- A failure to comply with any applicable state, local, city, or county electrical, plumbing and/or building codes, regulations, or laws, including failure to install the product in strict conformity with local fire and building codes and regulations.
- Ordinary wear and tear, spills of food, liquid, grease accumulations, or other substances that accumulate on, in, or around the Product.
- Any external, elemental and/or environmental forces and factors, including without limitation, rain, wind, sand, floods, fires, mud slides, freezing temperatures, excessive moisture or extended exposure to humidity, lightning, power surges, structural failures surrounding the appliance, and acts of God.

In no event shall Bosch have any liability or responsibility whatsoever for damage to surrounding property, including cabinetry, floors, ceilings, and other structures or objects around the Product. Also excluded from this warranty are scratches, nicks, minor dents, and cosmetic damages on external surfaces and exposed parts; Products on which the serial numbers have been altered, defaced, or removed; service visits to teach you how to use the Product, or visits where there is nothing wrong with the Product; correction of installation problems (you are solely responsible for any structure and setting for the Product, including all electrical, plumbing or other connecting facilities, for proper foundation/flooring, and for any alterations including without limitation cabinetry, walls, floors, shelving, etc.); and resetting of breakers or fuses.

**TO THE EXTENT ALLOWED BY LAW, THIS WARRANTY SETS OUT YOUR EXCLUSIVE REMEDIES WITH RESPECT TO PRODUCT, WHETHER THE CLAIM ARISES IN CONTRACT OR TORT (INCLUDING STRICT LIABILITY, OR NEGLIGENCE) OR OTHERWISE. THIS WARRANTY IS IN LIEU OF ALL OTHER WARRANTIES, WHETHER EXPRESS OR IMPLIED. ANY WARRANTY IMPLIED BY LAW, WHETHER FOR MERCHANTABILITY OR FITNESS FOR A PARTICULAR PURPOSE, OR OTHERWISE, SHALL BE EFFECTIVE ONLY FOR THE PERIOD THAT THIS EXPRESS LIMITED WARRANTY IS EFFECTIVE. IN NO EVENT WILL THE MANUFACTURER BE LIABLE FOR CONSEQUENTIAL, SPECIAL, INCIDENTAL, INDIRECT, "BUSINESS LOSS", AND/OR PUNITIVE DAMAGES, LOSSES, OR EXPENSES, INCLUDING WITHOUT LIMITATION TIME AWAY FROM WORK, HOTELS AND/OR RESTAURANT MEALS, REMODELLING EXPENSES IN EXCESS OF DIRECT DAMAGES WHICH ARE DEFINITELY CAUSED EXCLUSIVELY BY BOSCH, OR OTHERWISE. SOME STATES DO NOT ALLOW THE EXCLUSION OR LIMITATION OF INCIDENTAL OR CONSEQUENTIAL DAMAGES, AND SOME STATES DO NOT ALLOW LIMITATIONS ON HOW LONG AN IMPLIED WARRANTY LASTS, SO THE ABOVE LIMITATIONS MAY NOT APPLY TO YOU. THIS WARRANTY GIVES YOU SPECIFIC LEGAL RIGHTS, AND YOU MAY ALSO HAVE OTHER RIGHTS WHICH VARY FROM STATE TO STATE.**

No attempt to alter, modify or amend this warranty shall be effective unless authorized in writing by an officer of BSH.

**Notes:**





**BOSCH**

Invented for life