

D 6633

D6634

D6633 TS

D6634 S

BEKO

Oven

Operating Instructions

English version of the 285.6131.03
booklet (04.11.2004)



**This product ,
is produced in modern facilities which
are respectful to environment,without
giving harm to the nature**

Dear Customer,

It is our ultimate desire that you achieve the best performance from our product, which has been passed through meticulous quality control checks and is manufactured in modern facilities.

To this effect, we recommend that you read the entire guide carefully before operating the product and keep it as a reference.

BEKO

www.beko.com.tr



This product has 10 years life span.
It means that said period is time interval to stock its spare parts to keep this product functional.

Contents

1	Technical specifications	Page 2	5	Process that you must do before calling services	Page 21
2	Safety precaution and important items	Page 3	6	Important do's and dont's	Page 22
3	Superior properties of product, practical and useful informations	Page 4			
	Superior features.....	4			
	Introducing the control panel.....	5			
	Using of top burners.....	6			
	Using of oven part.....	8-11			
	Operating the timer.....	12-15			
	Transport.....	16			
4	Maintenance and cleaning	Page 17			
	Lamp changing.....	18			
	Gas installation.....	19			

1 Technical specifications

Outer width	: 600 mm
Outer depth	: 600 mm
Outer height	: 850 mm
Inner width	: 445 mm
Inner depth	: 410 mm
Inner height	: 332 mm
Oven volume	: 61 lt.
Drawer volume	: 44 lt.
Burner capacity (gross)	
Rapid burner-Front right	: 2900 W
Semi-rapid burner-front left	: 2000 W
Hot plate -rear left	: Ø 180, 1000 W (D 6633TS- D 6633)
Semi-rapid burner-rear left	: 2000 W
Auxiliary burner-rear right	: 1000 W
Supply voltage	: 220 V ~ 50 Hz
Grill output	: 2000 W
Torbo motor power	: 2300 rpm/35 W
Lamp (if available)	: 15 W/25W
Total power -	: 2160 W (D 6634/ D6634 S)
	: 3160 W max (D6633/ D6633TS)
Ignition	: electrical, automatic on top burners
Safety	: Locking system for taps

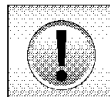

The datas and values about this product are obtained in laboratory test conditions therefore these values can be changed according to the usage and working conditions.

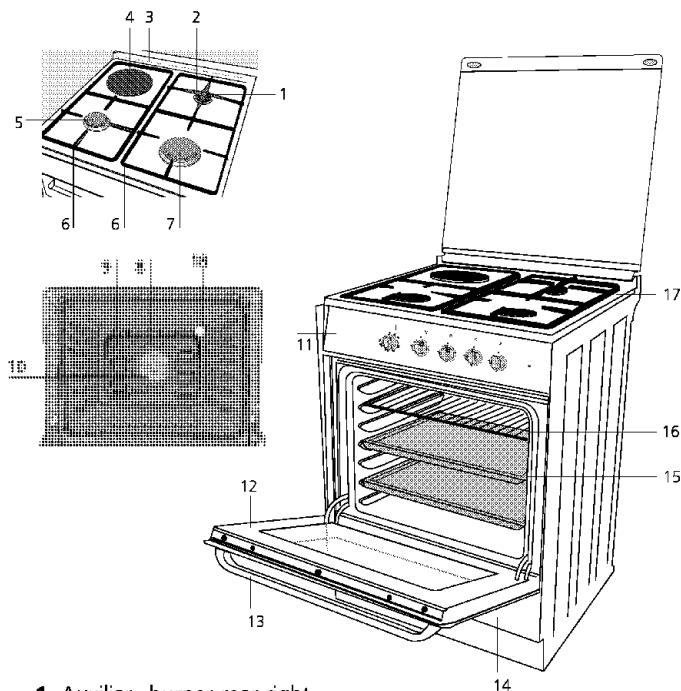

- 1. Auxiliary burner-rear right
- 2. Pan support adaptor
- 3. Integral air grille
- 4. Semi-rapid burner-rear left
- 5. Semi-rapid burner-front left
- 6. Pan supports
- 7. Rapid burner-Front right
- 8. Turbo heater
- 9. Air exit hole
- 10. Air inlet hole
- 11. Control panel
- 12. Front door
- 13. Handle
- 14. Bottom part
- 15. Trays
- 16. Grill shelf
- 17. Burners' plate
- 18. Lamp

2 Safety precautions and important items

- * The current value of the fuse in your home shall be suitable to the current drawn by your cooker.
- * Before your appliance is connected to the mains electricity supply, check to ensure that the voltage and the frequency shown in the data plate corresponds with your power supply. The data plate is situated back cover of the oven, or it is situated in the front of the storage compartment and can be seen by opening the storage compartment cover or pulling the drawer.
- * Before applying to authorized service, have the electrical wiring of your home ready for connection.
- * The ground cable should always be performed by the manufacturer or its authorized service agent or a similarly qualified person. Our company shall not held responsible for any damage caused by the utilisation of the oven without ground cabling.
- * If the current value is less than 16 Amperes please have 16 A fuse with electrician.
- * Before your appliance is connected please call authorized Arçelik service. This product is available for LPG gas bottle. To adjust your appliance for natural gas

- please contact Arçelik Service.
Please do not turn upside down LPG bottle while using.
- * While locating your oven; do not squeeze the supply cord under the oven body or inside the oven door, because the cable isolation can be damaged.
 - * If the supply cord is damaged, it must be replaced by the manufacturer or its service agent or a similarly qualified person in order to avoid a hazard.
 - * In models with the timer:
Always adjust the timer during the first operation or after any interruptions of the electric supply. Otherwise, your oven will not operate.
 - * Do not attempt to move the appliance by pulling the door and/or handles.
 - * While the front door is open do not put any heavy object on it, and do not allow children to sit on it.
 - * Accessible parts of the appliance will become very hot whilst the appliance is in use and until the appliance has cooled. Children should be kept away to avoid burns and scalds.
 - * The packaging materials can cause danger for the children.
 - * The appliance is not intended for use by young children or infirm persons without

- supervision.
- * Do not forget to remove the packaging material near the tray and wire grill, and the polysthrene stuck to the front door glass.
 - * Whilst the appliance is in use; avoid touching heating elements inside the oven as the accessible parts of the appliance will become very hot.
 - * Please ensure that top burner knobs are off position before closing of top lid. Otherwise top lid glass may crack.
 - * Always switch off the appliance from the mains when the appliance is not in use before cleaning or in the unlikely event of any probable product failure.
 - * Ensure the appliance is switched off before replacing the lamp, to avoid the possibility of electric shock.
In models with Grill;
Always use oven gloves when removing the grill rack and dishes from inside the oven when in use.
 - * If, whilst cooking, steam produced comes into contact with cool surfaces on the outside of the appliance, it will condense and produce water droplets. This is quite normal and is not a fault. Wipe it with a dry cloth.

3 The superior features of your oven

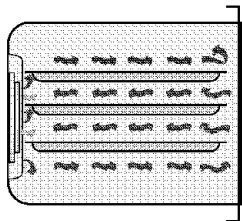

Turbo oven:

In this position, you can perform the functions listed below by operating the turbo-heating element and turbo-fan.

* In timer equipped models; timer and heater are connected serially. Therefore, to run heater, your timer must be adjusted (please refer timer guide).

* For food that is cooked at the same temperature but has different cooking times, you should set the oven program according to food which has shortest cooking period. Set the additional duration for the remaining foods after taking out the food that has first been cooked.

* Energy conservation can be achieved with your oven by cooking two or three different foods at the same time, without mixing their odours.

* Pierce the dough to prevent the space between the trays from becoming blocked through swelling while cooking pastries in the turbo position using three trays.

 In this position you can grill.

Before performing grilling, make sure to oil the grill with cooking oil.

Introduction of control panel

D 6633
D 6634 S
D 6634

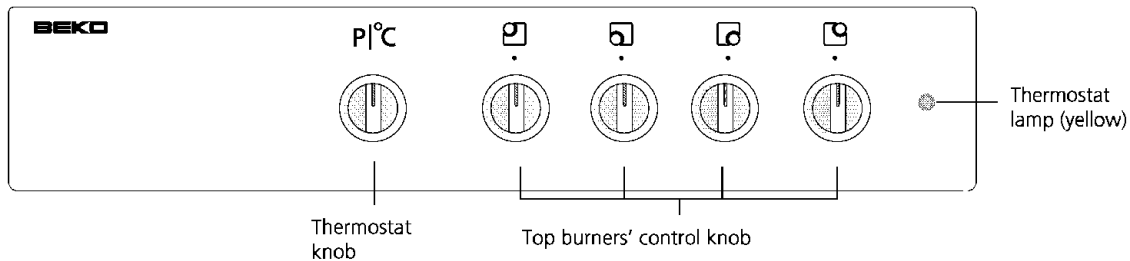

D6633 TS

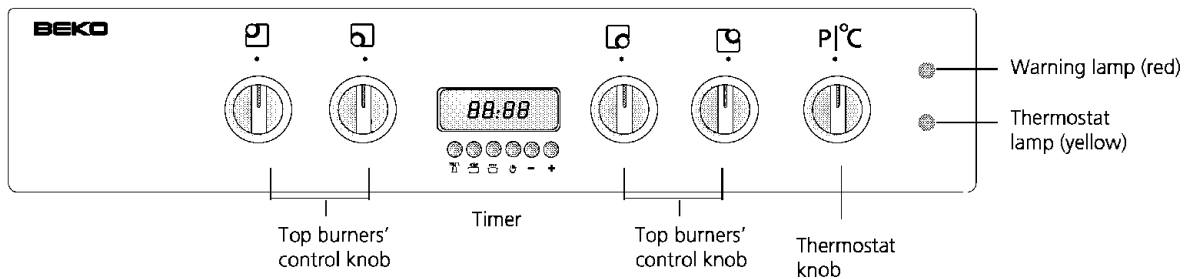

Warning lamp (red)

Indicates hob operation.

Thermostat lamp (yellow): If oven inner temperature exceeds your setted temperature, thermostat cuts off your appliance circuit and turn off lamp.

Operating the top burners

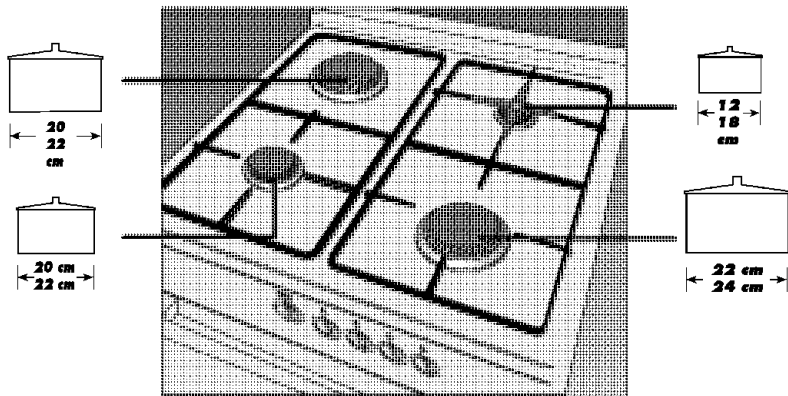

To obtain maximum efficiency

A correct use to burner results in gas saving and better out put. Therefore we recommend to use saucepans whose base completely cover the flames.

Four saucepans with much smaller diameters to be put auxiliary burner, use the pan support adaptor.

Use of top gas burners

Turn the relevant knob by slightly pressing in counter clockwise direction.

The large flame on the knob corresponds to maximum capacity position and the small flame corresponds to minimum capacity position.

Ignition from the knob In models with ignition;

You should turn the knob to counter-clockwise direction by pressing. The spark occurs itself immediately on the burners till you take your hand off the knobs.

After you release the knob, if the ignition does not continue repeat the same process by keeping the knob pressed for 15 seconds. If still no ignition occurs, wait for **1 minute** and repeat again.

Warning : Do not keep the knob in pressed position more than 15 seconds.

Operating the hot plates

Hotplate control position	Corresponding Cooking Values					
	1	2	3	4	5	6
Application	Warming	Simmering	Cooking-Frying-Boiling			

A rapid heating hotplate is denoted by a red spot in the centre of the hotplate:

Hotplate operating knobs

The knobs for the hob can be rotated in either direction to provide fully variable heat control. When any one of the hotplates is on, **the red indicator light on the control panel will be on.**

In order to switch the hotplate **OFF** turn the corresponding knob to the **0 (zero)** position. **Check that all the cooker controls have been switched off after use.**

Adjust the hotplates to mid position (3) and leave on for approximately 8 minutes in order to burn off the protective coating on the hotplates. Do not place any pans or other cooking utensil on the hotplates during this process. Fumes will be emitted during the above operation but this is quite normal.

You should adjust the electronic timer prior to using the hob. Otherwise your hob will not operate.

Good Quality Pans

* Use only good quality pans having a stable bottom as shown below. This results in the maximum use of energy.

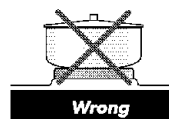
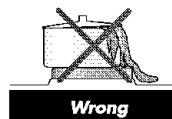
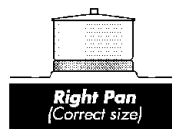

* Use pans for the correct diameter only. If the pan is too small energy is wasted.

* Do not place pans with wet bases or pan lids particularly wet lids on the hotplates damage could occur and safety problem will be experienced.

Hotplate diameter (mm)	Suggested diameter of the pan (mm)
------------------------	------------------------------------

Ø 220mm	→	220-240
Ø 180 mm	→	180-200
Ø 145 mm	→	150-170

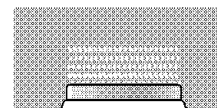
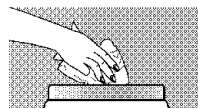

*** Drying the hotplates (max 5 min)**

- * When cool;
- * Clean off solid hotplates with a damp cloth and a little domestic cleaning cream. After cleaning, dry solid hotplates by switching on for a short time. Apply a thin coat of cooking oil from to time.
- * When wiping the hotplates with a damp cloth follow the circular grooved pattern on the hotplate.

Using of oven part

Oven heating control knob

- * The oven/or grill knob can only be rotated clockwise from the OFF position
- * Turn the oven on by rotating the oven knob clockwise.
- * Adjustment of the temperature in the oven is also made by using this knob.
- *The temperature values are written on the oven control knob. The amber temperature indicator light will glow until the pre-set temperature set using the oven knob is reached. Once the temperature has been reached, the amber light will go off and then cycle on and off during use to maintain the pre-set temperature.

The temperature in the oven shall be sensed by the thermostat. The thermostat switches off the heating element and the thermostat light when the set temperature level is reached inside the oven. When the temperature falls below thermostat comes back on line and the thermostat light illuminates. This way, the set temperature level is maintained throughout the cooking period.

- * The kinds of food you want to cook, thermostat positions, shelf positions and recommended cooking times are given at the cooking table.
- * Bring the knob to the position you want.
- * Preheat the oven for 10 minutes with oven door closed.
- * Locate the meal you want to cook into the oven after preheating.
- * After cooking, bring the knob to the "0" position.

Using the oven's timer ; If your oven has a timer; You can do full automatic, semi automatic and manual cooking. You should adjust the electronic timer prior to using oven. The electrical current to the heating elements flows through the electronic timer. The timer must be set in order for the heating elements to go into operation. In automatic cooking; do not leave spoilable foods in the oven up to cooking start time.

The stages of the thermostat control knob



Oven lamp and fan are on.

(75-250 range):

Turbo heating element is on.



Means only the grill heater is on. To set the knob "0" position after this stage, turn the knob in the counter-clockwise direction.

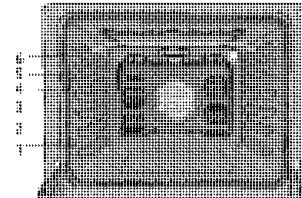

Cooking table

Foods	COOKING PAN	SHELF POSITIONS	THERMOSTAT POSITION	COOKING TIME (min)
		Fan with ring heater		Fan with ring heater
Short bread (Serves 8)	24-26 cm bread mould	3	170-180	15-25
Cake in mould (Serves 5)	18-22 cm cake mould	3	170-180	20-30
Cookie (Serves 12)	Cooking sheet	4	170-190	20-30
Flaky pastry (Serves 12)	Cooking sheet	4	180-190	20-30
Brioche	Cooking sheet	4	160-180	20-30
Pastry (Serves 8)	Big tray	4	180-190	35-45
Yeast dough (Serves 18)	Big tray	4	190-200	25-35
Biscuits (Serves 10)	Cooking sheet	4	170-180	15-25
Cake (Serves 20)	Big tray	4	170-180	20-30
Millefeuille pastry (Serves 8)	Big tray	4	200-210	20-30
Lasagne (Serves 8)	Lasagne dish	4	170-180	35-45
Pizza (Serves 8)	Big tray	4	200-220	20-30
Roast beef (Serves 8)	Roasting dish	4	250 (15min)*	90-120
Lamb shoulder (Serves 8)	Roasting dish	4	250 (15min)*	65-80
Roasted chicken	Roasting dish	4	250 (15min)*	55-65
Roasted turkey (5,5 kg)	Big tray	4	220 (25min)*	170-220
Fish	Roasting dish	4	200	15-20

*For roasted meats, the thermostat starts with the highest level and decreases to 150°C after 15 minutes.

- The values listed in the table are the results obtained from laboratory testing.
- You may find different flavours of the food according to your own cooking and usage practices.
- If you wish, you can add the time it takes to pre-heat the oven to the values listed in the table.

Shelf position (In fan with ring heater model)
 For 3 trays : 2 - 4 - 6
 For 2 trays : 4 - 6
 For 1 trays : 4

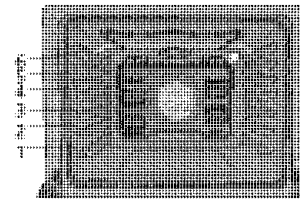

Note: The values on the cooking table are the results we got in our laboratory.

The cooking table may be changed according to the quantity of products. You can find different tastes suitable for your harmony according to your cooking and using habits.

* If you want use the oven tray and want to make a cooking in another pot, prefer the right cooking adjustment because of your experiences.

* Don't use the pots that have heat perfecting or bad conduction and glass pots for making cooking pastry. The oven tray is the convenient off all.

* To use mold makes a better result for cooking cakes

* The cooking time may be changed according to the quantity of products.

* When putting the trays into the oven, be careful to put the trays on a level with others.

* Before cooking, make a first heating for 10 minutes , then put your food into oven.

* 5 minutes prior to the finishing time you can close the system for providing energy savings with non- opening the door.

To get the passing of steam from oven to exhaust, the lid should be opened when using oven.

The accessories on product (according to different models)

* Grill; For grilling or putting saucepan when using another pot in oven.

* Oven tray (grand); For cooking pastries.

* Grill in tray; For grilling

* Deep tray; For cooking the watery foods, recommending

* Glass tray; For cooking the watery foods, recommending

WARNING ABOUT THE GLASS TRAY

* After cooking, don't put the glass tray that you out of the oven on wet and cold surface. Wait for it's cooling on a dry cloth.

* Don't put the glass tray, that you take out of the refrigerator, into the hot oven.

* Don't cut the material in glass tray with knife.

* Don't clean the trays of the oven with materials such as hard brush, dish fiber or knife. During cleaning, don't use materials with sharp edge.

* Do the cleanings of glass surface with special glass cleaning materials.

For pastries like cake etc. use enamelled tray.

Operating the grill

- **Always keep the oven door closed when grilling.**

- ☛ Preheat the grill at  (grill setting) for approximately 5 minutes. For this period the heat control knob shall be at the **max** setting and the door must be closed.
- ☛ The indicator light will illuminate to show that the grill is switched on.
- ☛ Apply oil on the grill shelf to prevent meat from sticking on the bars.
- ☛ Put a tray on one of the bottom shelves in order to collect oil and for easy cleaning put some water in it.
- ☛ Use 4 or 5. shelf position for grilling.
- ☛ **Do not allow children to sit or stand on the oven door when the door is open.**

- Ensure the food is correctly positioned under the grill element.
- Food which requires browning only should either be placed under the hot grill in the grill pan, or on the floor of the grill compartment, according to the depth of the dish. The grill pan wire grid may be removed.
- Do not line the grill pan with aluminium foil as the increase in heat is a fire hazard.
- Plates and dishes placed on the floor of the grill compartment will be heated when the main oven is in use.



☛ Accessible part may become hot when the grill is in use. Don't allow children to be close.

If tray and thread grill are given with oven; use these when making grill.

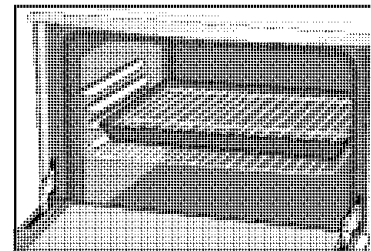

	Grill 	
	Shelf position	Cooking duration (min.)
Lamb	4 - 5	12-15
Lamb chops	4 - 5	12-15
Beef		
Veal chops	4 - 5	15-25 (1)
Mutton chop	4 - 5	15-25 (1)

(1) Depending on the thickness

Shelf positions

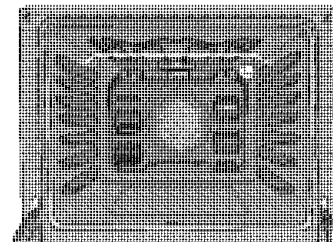

- 6. shelf
- 5. shelf
- 4. shelf
- 3. shelf
- 2. shelf
- 1. shelf



Operating the timer (If your cooker has a timer)

Setting the electronic timer





You should adjust the electronic timer prior to using the oven. Otherwise your oven will not operate.

Your oven's electronic timer is operated similar to a normal timer. Your oven's electronic timer will be reset if the electrical power is cutoff. The electronic timer will run slow if the frequency of your supply power is not appropriate (This malfunction is not due to your timer itself. In such cases, you must re-adjust your timer).

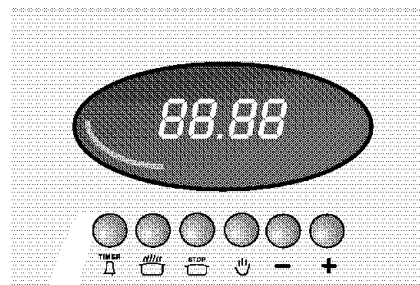
The following functions are available on your programmable timer.

1. You can adjust cooking durations between 00.00 - 24.00 hours.
2. You can use it as a chiming alarm between 00.00 - 24.00 hours.
3. You can run a cooking program for fully-automatic, semi-automatic and non-programmed (manual) cooking. (The heating elements inside the oven are tied into the electronic timer and are programmable.





-  : Programming button for warnings
-  : Cooking period adjustment button
-  : Cooking terminating time adjustment button
-  : Manual adjustment button (non-programmed cooking)
-  : Time adjustment buttons

Please note

- * The timer controls the oven heating element only and the current time of day must be set before the oven will function.
- * If the timer has been set to an automatic or semi automatic programme, the daily time cannot be readjusted, the semi or auto programme, must be cancelled. See **"How to cancel automatic programme"**.



How to set the current time of day

The clock display uses a 24 hour configuration
8:30 pm = 20:30

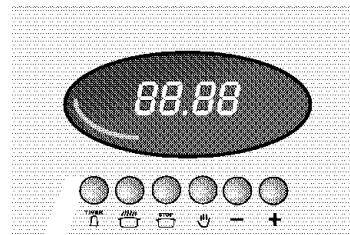
- * Press and hold "   " buttons at the same time.
- * Press "+" button to increase or "-" to decrease, the time.
- * Adjust using the "+" or "-" buttons to set the current time. If **"Auto"** flashes, See **"How to cancel automatic programme"**.
- * Release the buttons, the clock will now start.



Manual cooking (or to cancel a programme)

- * Press "  " button, press the "-" button, until 0:00 is displayed.
- * Press the "  " button.

The **"auto"** and "  " sign will disappear.

- * Set the oven knob to the required cooking temperature and function selection knob to the desired position.
- * The oven will switch on. The Amber oven indicator will light.
- * At the end of cooking, switch off by resetting the oven thermostat knob to the "●" (off) mark.

Note:

The timer will not switch off the oven. To switch off the oven turn the oven thermostat and selection knob to the "●" (off) mark.

Semi-automatic programming

This mode allows a manual start time but an automatic switch off time, which is very useful to prevent the over cooking of food.

- * Press "🕒" button. Press the "+" (or "-") buttons, to set the cooking time duration (Auto and "🕒" will be displayed) in minutes.
 - * Set the oven thermostat knob to the required temperature and function selection knob to the desired position.
 - * The oven will switch on and cooking will commence.
 - * The programmer will switch the oven off at the end of the preset cooking time. "Auto" will flash and the timer alarm will beep.
- To turn off the alarm press the "STOP" button.
- * Set the oven thermostat knob to the "●" (off) mark.
 - * Press "🕒" button to cancel "Auto".

Automatic programming

The programmer will switch the oven on and off at the required times.

Ensure the oven thermostat is in "●" (off) position, and the correct time has been set.

- * Press the "🕒" button to cancel any program stored. (Auto and "🕒" symbol will not be displayed)
- * Press the "STOP" button and press "+" (or "-") buttons, to set the stop time required. (🕒 and auto will be displayed)
- * Press the "🕒" button and press "-" button to set the cooking time (duration) required.
- * Set the oven knob to the required cooking temperature and place your food in the oven.
- * The oven will switch on at the required time, cook the food and switch off at the predetermined time.
- * At the end of cooking the alarm will beep and "Auto" will flash. To turn off the alarm press the "STOP" button.

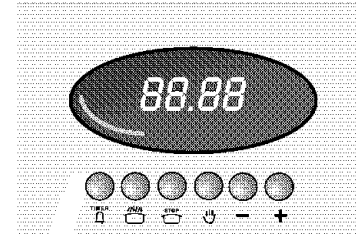

Press “👉” button to cancel “Auto”.

* Set the oven thermostat and function selection knob to the “●” (off) mark.

Note: Make sure you follow food manufacturer’s instructions.

* Press the “👉” button to view the remaining cooking time during cooking.

Timer alarm

The timer alarm can be adjusted to bleep between 0 and 23 hours 59 minutes. i.e. as a minute minder to remind you to switch off a hob heating zone.

* Press the “🔔” button, press the “+” or “-” buttons to set the desired alarm time.

* The timer alarm will bleep at the end of the time period.

* To turn off the alarm press the “🛑” button.

How to cancel automatic programme

* Press “👉” button, press “-” button until the clock display shows 0:00

* Press “👉” button, the programme has now been cancelled.

* The current time can then be reset.

(If Available)

Activating the Demo mode/Key lock

The Demo mode is conditionally applicable as key lock. If it is activated, the relays remain open all the time.

Thus timer can be operated as usual but the connected appliance or appliance module remains unaffected. This means that your child can select the cook program but the program will not be activated and thus the connected appliance or appliance module will not be switched on.

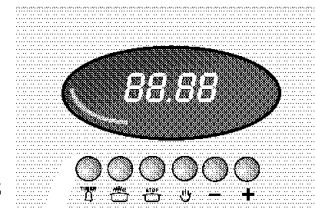

To activate the demo mode/key lock:

1. Make sure that the clock is in manual mode and cancel any active programs.

2. Hold the “🔔” button and the “👉” button down simultaneously for approx. 8 seconds. The display will read “ON”.

3. Press the “+” button.

The display reads “OFF” and the “👉” symbol appears. After approx. 5 seconds the time reappears next to the “👉” symbol. The key lock is now activated.

To deactivate the demo mode/key lock:

1. Make sure that the clock is in manual mode and cancel any active programs.

2. Hold the “🔔” button and the “👉” button down simultaneously for approx. 8 seconds. The display will read “OFF”.

3. Press the “+” button.

The display reads “ON” and the “👉” symbol disappears. After approx. 5 seconds the time reappears on the display. The key lock is now deactivated.

Future transportation

*** Transporting the oven;**

Store the oven's original box. Transport the oven in its original carton. Follow the guidance marks that are printed on the carton.

To prevent the wire grill and tray inside the oven from damaging the oven door, place a strip of cardboard or paper 1 to 1.5 cm in thickness onto the inside of the oven door that lines up with the position of the trays. Tape the oven door to the side walls.

*** If you do not have the original carton;**

Take the necessary precautions in order to prevent the exterior panels, and the glass surfaces of the oven from being damaged.

Pack the oven in bubble wrap or thick cardboard and tape it securely in order to prevent damage during transportation.

The oven must be transported upright. Do not place other items on the top of the cooker.

4 Maintenance and cleaning

Turn off the mains switch before cleaning

* Before switching on again ensure that all controls are in the OFF position.

* Make sure that the oven, grill and burners are sufficiently cool before you start cleaning.

* Your product is manufactured in a manner that it should not overflow the oily food juices under the counter. The pan supports can easily be removed and the top burner plate can be cleaned with soapy water, and rinsed with a dry cloth.

* Wash and rinse the gas burner caps and the pan supports with soapy water. **Never wash the gas burner caps and the pan supports in the dishwasher.** For the dirt and stains on the burner heads that can not be cleaned, use the metal surface cleaners you can obtain from the market according to their instructions.

* It is recommended that the acidic matters such as oil, lemon etc. should be cleaned immediately.

* Use a damp cloth to clean the interior and exterior. Never use any sharp instruments, abrasive household cleaner, or detergents for cleaning. For hard stains use suitable washing liquid.

* Ensure that the door seal is dry after cleaning. We recommend that grill elements be wiped with a damp cloth to remove any fat splashes. This will prevent fumes for any fat being burned off when the cooker is next used.

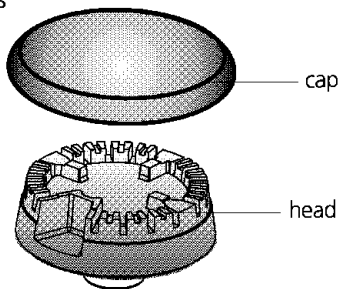

Vitreous enamel hob surround

Clean with a cloth wrung out in soapy water. Stubborn stains can be removed with a cream, paste or liquid cleaner. Check that the cleaning agent used is approved by the Vitreous Enamel Development Council.

* Never clean the cooker surface by using materials such as hard brushes, steel pads or knives, which can easily scratch the enamelled and stainless steel surfaces.

* Special cleaners that are commercially available may be used after carefully reading the warning labels written on them. Do not use cleaning agents containing acid or chlorine.

Cleaning can be accomplished using a soft piece of cloth wetted with soapy water or with commercially available special surface cleaners and a soft piece of cloth. Especially use liquid paste or cream type cleaners.

Control panel

Wipe over the control panel with a damp cloth and polish with a dry cloth. Do not use oven cleaners or aerosols, scouring pads or abrasive powder for cleaning the plastic knobs as damage will occur. Do not attempt to remove any of the control knobs from the panel as this may cause damage and is a safety hazard.

Oven interior

Before switching on again ensure that all controls are in the OFF position. Take out all trays and the grill out of the oven. Clean out the interior with a piece of moist, soapy cloth. Then, clean it once more with a wet piece of cloth and let it to dry.

Do not use dry powder agents for cleaning.

Special cleaners that are commercially available may be used after carefully reading the warning that are written on the labels.

*** Catalytic-enamelled models;** The oven interior of this model is coated with catalytic enamel since the catalytic enamel cleans itself, you do not have to perform an extra cleaning after the cooking operation.

If your oven obtains steel rack;

To clean the steel rack, unscrew the 4 screws. After cleaning operation, assemble the steel rack to the oven body again.

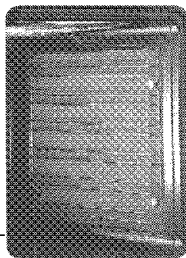

Warning!

Never clean the inside of the oven and trays with hard brushes, steel pads or knives. Do not use cleaning agents containing acid or chlorine on **stainless steel surfaces and the handle**. Cleaning can be accomplished using a soft piece of cloth wetted with soapy water or with commercially available special surface cleaners and a soft piece of cloth.

Do not use these materials for cleaning

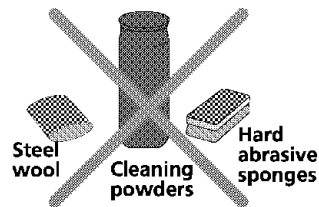

Replacing the oven lamp (In models with lamp):

1. Unplug the power cable.
2. Then, remove the protective glass cover of the lamp inside your oven by turning it counterclockwise.
3. Then, remove the bulb by turning it counterclockwise.
4. After installing the correct bulb obtained from an Authorized Service, reinstall the protective glass of the lamp.

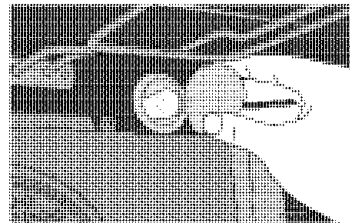

Installation of gas

*Before your appliance is connected to the gas supply, check the ensure that the gas category and pressure specifications shown in the data plate corresponds with your gas supply. If necessary call authorized service for adjusting to gas category.

*This appliance shall be installed in accordance with the regulations in force and only used in a well ventilated space. Read the instructions before installing or using this appliances. In the interest of safety this appliances must be installed and/or serviced by a competent person as stated in the gas safety regulations current editions.

* Please refer to the data plate for details about gas supply and pressures.
* The appliance must not be installed in a room without a window or other controllable opening. If is installed in a room without a door which opens directly to tohe outside, a permanent opening is required.
The air circulation should be 2 m³/h per kW of burners.

If your cooker adjusted for natural gas;
Natural gas valve must be easy reachable position.

Connection of the gas hose to the oven

Convenient position is selected by interchanging the hose nozzle and plug according to the location of the main gas inlet valve. If you make a connection with a flexible metal hose , locate a seal between the main gas pipe. The inner diameter of the flexible hose, which the butane hose nozzle is connected, should be 6mm for the house-type gas tubes.

The inner diameter of the flexible hose, which the natural hose nozzle is connected, should be 15mm. The hose should tightly be fitted to the hose nozzle by squeezing with a clamp. The plastic hose end is soaked in hot water for one minute to soften and inserted fully into the hose nozzle. The clamp is fastened securely by a screw driver. The other end of the hose is connected to the gas valve with the same operation.

The hose should be replaced before its last expiry date.

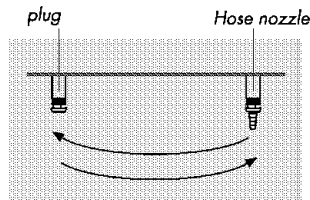

Caution!

Make the oven connection to the gas inlet valve, the hose length must be short and be sure that there is no leakage. The hose used should not be longer than 125 cm for safety.

Gas leakage control

During control, be sure that the control knobs are closed and the gas inlet valve is open. Apply soap bubbles to the connections for leakage control. In case leakage exists, buble will appear. In such case, check the gas connection immediately. Do not control gas leaks by using fire.

Caution!

Never use lighter or match flame, for controlling the gas leakage.

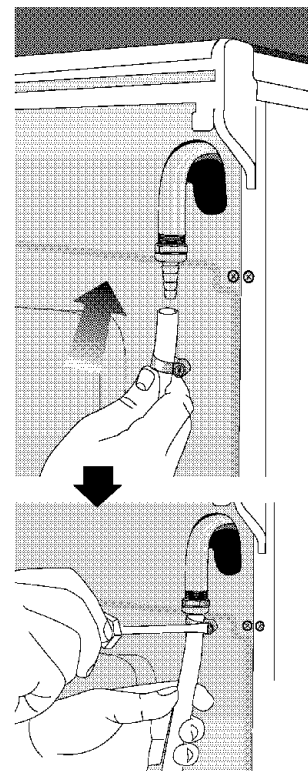

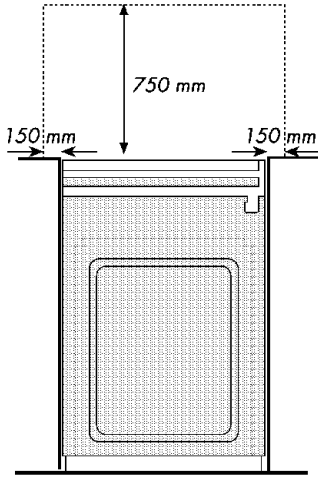

Adjacent side walls above the appliance must not be nearer to the cooker than 150 mm and should be of heat resistant material. Leave at least 750 mm clearance above the hotplates.

The appliance should be located on a level surface.

The two front feet can be adjusted as required. To ensure that your appliance is standing level adjust the two front feet by turning clockwise or counterclockwise until the product is in firm contact with the floor.

5 Process that you must do before calling service

Before calling service, please do the controls below



If the oven is not heating;

Your product's plug can be not connected to grounded socket. Fuse can be off. In the models with clock, clock can be not set up.



Is temperature device mode with oven heating remote-control device knob?



Is the fuse of socket that the oven's connected or main fuse off?



If light is not ignite;

Is the plug installed to socket? Is the burner head is right position? Is the spark plug dirty or moist?



If gas burner is not working;

Be sure; LPG gas bottle is not exhausted or gas inlet valve is not close. Also it can be natural gas is not coming or burner should be moist. In the gas safety models; if burner is not occur, turn the button keep pushing for 5 secs.



If internal illumination lamp is off;

Is there electricity? Can the lamp be out of order? If its out of order, change it by looking guide.



Cooking (if top / bottom part is not cooking equal);

Control the temperature value, time of cooking and shelf positions according to using guide.



If there is still problem in the product; please call authorized service.

6 Important do's and don'ts

Don'ts

- * Don't leave children unsupervised where the cooker is installed and in use as all surfaces will get hot.
- * Don't allow children to sit or stand on the oven door when open in its down position or allow any person to sit or stand on part of the appliance.
- * Don't use large preserving pans or fish kettles across two hotplates as this will damage the hob.
- * Don't store items above the cooker that children may attempt to reach.
- * Don't use water to extinguish oil or fat fires.
- * Don't use the cooker as space heater, dryer.
- * Don't heat up unopened food containers as pressure can build up causing the container to burst.
- * Don't place flammable or plastic items on or near the hob, and never place wet cloths etc. on the hob to dry.
- * Don't use biological washing powder or harsh abrasives or chemical cleaners for cleaning the oven inner panels.
- * Don't leave a hotplate on for long periods when not covered by a pan. Spillage should be dealt with as soon as it occurs, taking due care as the hob surface

may be hot. Any spillage left on the surface after cooking should be cleaned off before the hob is switched on again to prevent baking on.

- * Don't store flammable materials, aerosol etc. In adjacent cabinets.
- * Don't cover ventilation slots in any way.
- * Don't use the handles to hang towels, dishcloths etc.
- * Don't use round-bottomed (traditional) woks. Use flat-bottomed types.
- * Don't place dishes, pans, trays directly onto the oven compartment base.
- * Don't cover oven shelves with aluminium foil as the air circulation in the oven will be disrupted.
- * Don't line the grill pan with aluminium foil.
- * Don't attempt to grill with the door closed.
- * Don't use the grill to warm plates.

Do's

- * Have your appliance installed by a qualified engineer or a technician.
- * Make sure you understand the controls prior to using your appliance.
- * Ensure that no flammable materials are adjacent to the appliance as the sides of the appliance become hot during

operation.

- * Keep children away from the cooker at all times when in use as surfaces will get extremely hot.
- * Always turn off the electricity supply at the wall switch before cleaning.
- * Check all controls on the appliance are switched off after cooking.
- * Keep all ventilation slots clear of obstructions.
- * Remember that the oven and the utensil will be very hot when in use.
- * Note that times and temperatures in this book are for guidance only.
- * Ensure meat and poultry is thoroughly defrosted before cooking.
- * Take care when removing utensils from the grill as they may be hot.
- * Take care when opening the door. Let steam and hot air escape before removing the food.
- * Use quality oven gloves for removing hot food utensils from the oven/grill.
- * Select the correct shelf position before turning the oven or grill on.
- * Clean your cooker regularly, ideally after each use.
- * Allow the appliance to cool before cleaning.
- * Always refer servicing to a qualified appliance service engineer.