

Portable MiniDisc Recorder

Operating Instructions

Recorder Operation _____ **page 11**

Software Operation _____ **page 32**



NetMD



MDLP

"WALKMAN" is a registered trademark of Sony Corporation to represent Headphone Stereo products.  is a trademark of Sony Corporation.

MZ-NE410

WARNING

To prevent fire or shock hazard, do not expose the unit to rain or moisture.

Do not install the appliance in a confined space, such as a bookcase or built-in cabinet.

To prevent fire, do not cover the ventilation of the apparatus with news papers, table cloths, curtains, etc. And don't place lighted candles on the apparatus.

To prevent fire or shock hazard, do not place objects filled with liquids, such as vases, on the apparatus.

Certain countries may regulate disposal of the battery used to power this product. Please consult with your local authority.

Caution

The use of optical instruments with this product will increase eye hazard.

CAUTION — INVISIBLE LASER RADIATION WHEN OPEN

AVOID EXPOSURE TO BEAM

Information

IN NO EVENT SHALL SELLER BE LIABLE FOR ANY DIRECT, INCIDENTAL OR CONSEQUENTIAL DAMAGES OF ANY NATURE, OR LOSSES OR EXPENSES RESULTING FROM ANY DEFECTIVE PRODUCT OR THE USE OF ANY PRODUCT.

For customers who purchased this product in the USA

Owner's Record

The serial number is located at the rear of the disc compartment lid and the model number is located at the top and bottom. Record the serial number in the space provided below. Refer to them whenever you call upon your Sony dealer regarding this product.

Model No. MZ-NE410

Serial No. _____

Product registration

Please register this product on line at www.sony.com/walkmanreg
<<http://www.sony.com/walkmanreg>>

Proper registration will enable us to send you periodic mailings about software upgrades, new products, services and other important announcements. Thank you.

If you have any questions about this product, contact:

- <http://www.sony.com/walkmansupport>
- **Sony Network Portable Audio Support Line**
1-(866)-456-7669
- **Sony Customer Information Services Center**
12451 Gateway Blvd. Fort Myers, FL 33913

Declaration of Conformity

Trade Name: SONY

Model No.: MZ-NE410

Responsible Party: Sony Electronics Inc.

Address: 680 Kinderkamack Road,
Oradell, NJ 07649 USA

Telephone No.: 201-930-6972

This device complies with Part 15 of the FCC Rules. Operation is subject to the following two conditions: (1) This device may not cause harmful interference, and (2) this device must accept any interference received, including interference that may cause undesired operation.

This equipment has been tested and found to comply with the limits for a Class B digital device, pursuant to Part 15 of the FCC Rules. These limits are designed to provide reasonable protection against harmful interference in a residential installation. This equipment generates, uses, and can radiate radio frequency energy and, if not installed and used in accordance with the instructions, may cause harmful interference to radio communications. However, there is no guarantee that interference will not occur in a particular installation. If this equipment does cause harmful interference to radio or television reception, which can be determined by turning the equipment off and on, the user is encouraged to try to correct the interference by one or more of the following measures:

- Reorient or relocate the receiving antenna.
- Increase the separation between the equipment and receiver.
- Connect the equipment into an outlet on a circuit different from that to which the receiver is connected.

— Consult the dealer or an experienced radio/TV technician for help.

You are cautioned that any changes or modifications not expressly approved in this manual could void your authority to operate this equipment.

SONY MZ-NE410



**Tested To Comply
With FCC Standards**

FOR HOME OR OFFICE USE

- SonicStage, OpenMG and the OpenMG logo, MagicGate, Memory Stick and the MagicGate Memory Stick logo, Memory Stick and the Memory Stick logo, Net MD and the Net MD logo are trademarks of Sony Corporation.
- Microsoft, Windows, Windows NT and Windows Media are trademarks or registered trademarks of Microsoft Corporation in the United States and /or other countries.
- IBM and PC/AT are registered trademarks of International Business Machines Corporation.
- Macintosh is a trademark of Apple Computer, Inc. in the United States and/ or other countries.
- MMX and Pentium are trademarks or registered trademarks of Intel Corporation.
- All other trademarks and registered trademarks are trademarks or registered trademarks of their respective holders.
- ™ and ® marks are omitted in this manual.

Notice for users

On the supplied software

- Copyright laws prohibit reproducing the software or the manual accompanying it in whole or in part, or renting the software without the permission of the copyright holder.
- In no event will SONY be liable for any financial damage, or loss of profits, including claims made by third parties, arising out of the use of the software supplied with this recorder.
- In the event a problem occurs with this software as a result of defective manufacturing, SONY will replace it. However, SONY bears no other responsibility.
- The software provided with this recorder cannot be used with equipment other than that which is so designated.
- Please note that, due to continued efforts to improve quality, the software specifications may be changed without notice.
- Operation of this recorder with software other than that provided is not covered by the warranty.

Program © 2001, 2002 Sony Corporation

Documentation © 2003 Sony Corporation

Table of contents

Recorder Operations

Looking at the controls	12
-------------------------------	----

Getting started!	14
------------------------	----

Playing an MD right away!	16
---------------------------------	----

Various ways of playback	18
Selecting the play mode	18
Adjusting treble or bass (Digital Sound Preset)	19
Selecting the sound quality	19
Adjusting the sound quality	19

Using the group function	21
What is the group function?	21
Playing a track in group play	21
Selecting the play mode for group play (Group Play Mode)	22

Other Operations	23
Viewing various information	23
Starting the playback quickly (Quick Mode)	24
Protecting your hearing (AVLS)	25
Locking the controls (HOLD)	25

Additional information	26
Precautions	26
Specifications	28

Troubleshooting and explanations	29
Troubles and solutions	29
While playing	29
While using group function	30
Others	30
Explanations	31

Software Operation

What is a Net MD?	33
<hr/>	
Basic Operations	34
Basic operational flow using the Net MD	34
Providing the required system environment	35
System requirements	35
Installing the software onto your computer	36
Before installing the software	36
Installing SonicStage Ver.1.5	37
Connecting the Net MD to your computer	39
Storing audio data to your computer	40
Starting SonicStage	40
Recording audio CDs to the hard disk drive	41
Labeling audio data	43
Transferring audio data from your computer to the Net MD (Check-out)	44
Checking out audio files to the Net MD	44
Listening to an MD	47
Listening to an MD with the Net MD connected to the computer	47
Listening to an MD with the Net MD disconnected from the computer	47
<hr/>	
Advanced operations	48
Using other functions!	48
Using the SonicStage online help	48

Other information	50
Settings and Precautions	50
Settings according to OS	50
For users with OpenMG Jukebox, SonicStage, or SonicStage Premium installed on their computer	52
Note on hard disk drive space	53
Notes on system suspend/hibernation mode	53
Backing up the audio data	53
Note on the battery	53
Uninstalling the SonicStage software	54
For Windows XP users	54
For Windows Millennium Edition/Windows 98 Second Edition users	54
For Windows 2000 users	55
Troubleshooting	56
If your computer does not recognize the Net MD	58
If the installation was not successful	58
If check-out (check-in) was not successful	59
Information and explanations	60
Net MD FAQ	60
On copyright protection	61
Glossary	63
Index	65

Before using this product

This recorder can only record materials from the connected computer. This manual explains the recorder operations and the installation and basic use of the supplied SonicStage software. For details on the various operations, refer to the pages indicated below.

When using the recorder

Recorder Operation (pages 11 to 31)

Pages 11 to 31 in this manual explain the use of the Net MD as an ordinary MiniDisc Walkman.



Troubleshooting and explanations (page 29)

This section shows the troubles you may find while using the recorder, and their solutions.

When using the Net MD (the recorder) connected to your computer

Software Operation (pages 32 to 64)

Pages 32 to 64 in this manual explain the installation and basic operations of the supplied SonicStage software. Refer to these pages for details.

Other information (page 50)

This section shows the troubles you may find while using the SonicStage software, and their solutions. It also has the list of frequently asked questions and answers.

SonicStage Ver. 1.5 Help

This is an online help that you can view on your computer screen.

Refer to online help for details on the use of the software. To display the help window, see page 48.

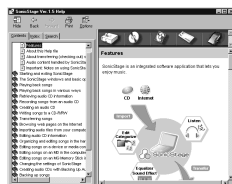

Notes on the "Software Operation" section

- The displayed items in the illustrations that appear in this section may differ from the actual items displayed by the software.
- Explanations in this section assume familiarity with basic Windows operations. For details on the use of your computer and the operating system, please refer to the respective manuals.
- Explanations in this section cover general Net MD products. For this reason, some explanations (and some illustrations) may not be applicable to your Net MD. Please refer to the operating instructions of your Net MD as well.

Checking the supplied accessories

Headphones/earphones (1)

Dedicated USB cable (1)

CD-ROM (SonicStage Ver. 1.5 and Net MD Simple Burner Ver. 1.1) (1)*

*Do not play a CD-ROM on an audio CD player.

Looking at the controls

Front of the recorder

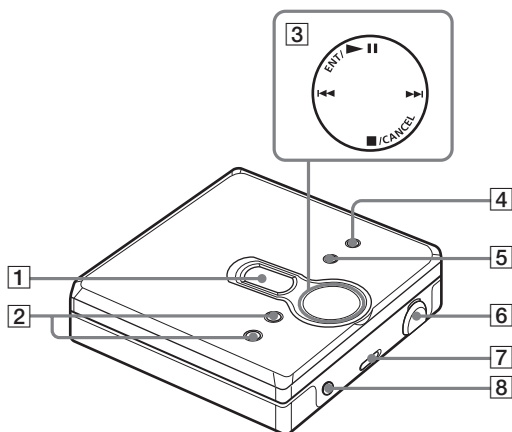

1 Display window

2 VOL +* and – button

* The VOL + button has a tactile dot.

3 4-position control key
ENT/▶|| (enter/play/pause)*
◀◀ and ▶▶ (search/AMS)
■/CANCEL (stop/cancel)

* The ENT/▶|| button has a tactile dot.

4 MENU button

5 GROUP button

6 USB jack

When connecting to your computer, connect the dedicated USB cable to this jack.

7 HOLD switch

8 ◡ (headphones/earphones) jack

Back of the recorder

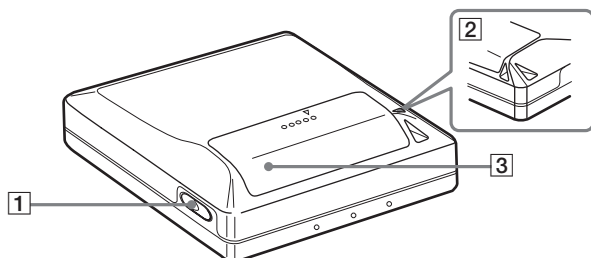

- 1** OPEN button
- 2** Hand strap hole
Use the hole to attach your own strap.
- 3** Battery compartment lid

The display window of the recorder

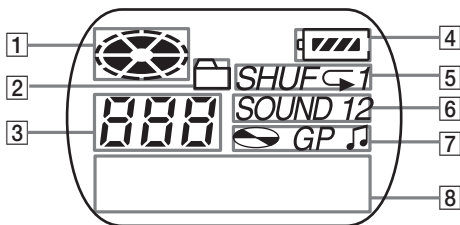

- 1** Disc indication
- 2** Group mode indication
Lights up when group mode is on.
- 3** Track number display
- 4** Battery level indication
Shows approximate battery condition.
- 5** Play mode indication
Shows play mode of the MD.
- 6** SOUND indication
- 7** Disc, group, track indication
- 8** Character information display
Displays the track names, elapsed time, etc.

Getting started!

1 Insert an alkaline dry battery.

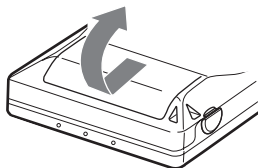

Slide to open the battery compartment lid.

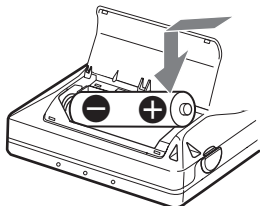

Insert one LR6 (size AA) alkaline dry battery minus end first.

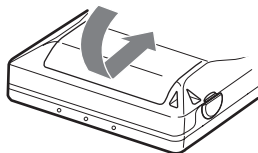

Close the lid.

When to replace the battery

You can check the battery condition through the battery indicator while using the recorder.



Battery power decreasing



Weak battery



The battery has gone out.

“LoBATT” flashes in the display, and the power goes off.

Battery life¹⁾

When	SP Stereo	LP2 Stereo	LP4 Stereo
playing ²⁾	Approx. 42 hours	Approx. 48 hours	Approx. 56 hours
checking out audio data from the computer ³⁾	75 tracks (of about 5 minutes each)	300 tracks (of about 5 minutes each)	600 tracks (of about 5 minutes each)

¹⁾ When using a new Sony LR6 (size AA) “STAMINA” alkaline dry battery (produced in Japan).

²⁾ Measured in accordance with the JEITA (Japan Electronics and Information Technology Industries Association) standard.

³⁾ The numbers of tracks that can be checked out differs according to the computer’s operating environment.

Notes

- Disconnect the dedicated USB cable before replacing the dry battery.
- The battery life may be shorter than that specified, depending on the operating conditions, the temperature of the location, and varieties of batteries.

2 Make connections and unlock the control.

- 1 Connect the headphones/earphones to .

- 2 Slide HOLD in the opposite direction of the arrow indicated on the recorder (HOLD ) to unlock the control.

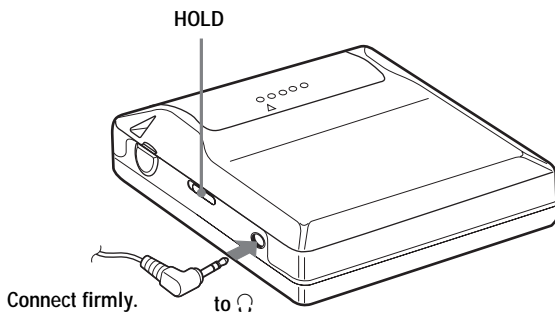

Playing an MD right away!

1 Insert an MD.

1 Press OPEN to open the lid.

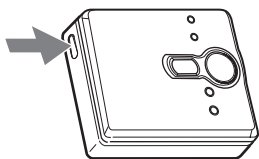

2 Insert an MD to the direction of the arrow with the label side facing front, and press the lid down to close.

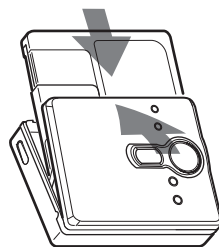

2 Play an MD.

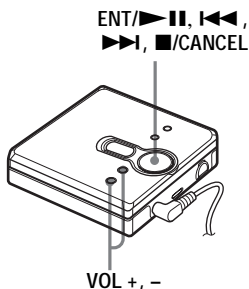

1 Press ▶||.

2 Press VOL + or - to adjust the volume. The volume indicator appears in the display allowing you to check the volume level.

To stop play, press ■.

Playback starts from the point you last stopped playing.

To start playback from the beginning of the first track, hold down ▶|| for 2 seconds or more.

To	Operation
Pause	Press ▶▶ . Press ▶▶ again to resume play.
Find the beginning of the current track or the previous track ¹⁾	Press ◀◀◀ . Press ◀◀◀ repeatedly until the beginning of the desired track appears.
Find the beginning of the next track ²⁾	Press ▶▶▶ once.
Go backwards or forward while playing	Hold down ◀◀◀ or ▶▶▶ .
Search for a point in a track while viewing the elapsed time (Time search)	While pausing, press and hold ◀◀◀ or ▶▶▶ .
Search for a specific track while viewing track numbers (Index search)	While the recorder is stopped, press and hold ◀◀◀ or ▶▶▶ .
Remove the MD	Press ■ , and then press OPEN. ³⁾

¹⁾ If you press **◀◀◀** twice continuously while playing the first track of the disc, the recorder goes to the beginning of the last track on the disc.

²⁾ If you press **▶▶▶** during the last track of the disc, the recorder goes to the beginning of the first track on the disc.

³⁾ If you open the lid, the playback will begin from the beginning of the first track (except when group mode is on).

Suppressing the skip of the sound (G-PROTECTION)

The G-PROTECTION function was developed to provide a higher level of shock resistance than that of existing players in order to allow the recorder to be used while jogging.

Note

The playback sound may skip if:

- the recorder receives stronger continuous shock.
- a dirty or scratched MiniDisc is played.



- The MZ-NE410 supports DSP TYPE-S for ATRAC/ATRAC3. It thus allows you to enjoy TYPE-S high-quality sound from MDs recorded in MDLP mode on TYPE-S-equipped MD decks, etc.
- The recorder can play the track recorded by 2 × or 4 × long playing mode (LP2 or LP4). Normal stereo playback, LP2 stereo playback, LP4 stereo playback or monaural playback is automatically selected to match the audio source.

Selecting the play mode

You can select various play modes such as normal play, single-track play (1 Trk), or shuffle play (Shuff). You can also select repeat play with the selected play mode.

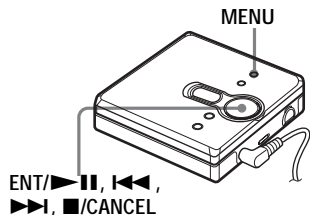

- 1 Press MENU.
- 2 Press ◀◀ or ▶▶ repeatedly until "P-MODE" appears in the display, and then press ENT/▶▶||.
- 3 Press ◀◀ or ▶▶ repeatedly to select the play mode, and then press ENT/▶▶||.

Each time you press ▶▶, the display item indicated by **A** changes as follows:

Pressing ENT/▶▶|| while **A** is flashing causes the play mode to enter.

Pressing ▶▶ repeatedly changes **A**.

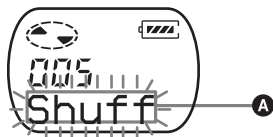

Display A ¹⁾	Play mode
Normal (normal play)	All the tracks are played once.
1 Trk (single-track play)	A single track is played once.

Display A ¹⁾	Play mode
Shuff (shuffle play)	All the tracks are played in random order.

¹⁾ Group play mode (◻) appears whenever you play a disc with group settings. For more details, see "Playing a track in group play" (page 21).

- 4 Press ◀◀ or ▶▶ repeatedly until "RepOFF" or "RepON" (playing a track repeatedly) appears in the display, and then press ENT/▶▶|| to enter the selection.

If you select "RepON", "◁" appears on **B** and the playback repeats with the play mode selected in step 3.

B lights up when you press ENT/▶▶||.

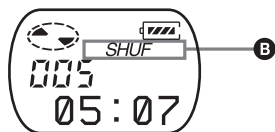

Display B	Play mode
◁	Repeat play of all tracks
◁ 1	Repeat play of a selected track
SHUF ◁	Repeat shuffle play of all tracks

To cancel the procedure
Press MENU.

To return the preceding settings
Press ■/CANCEL.

Adjusting treble or bass (Digital Sound Preset)

You can adjust the treble and bass to suit your taste. The player can store two sets of treble-bass adjustments, which can then be selected later during playback.

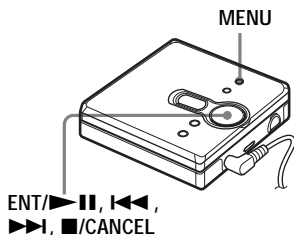

Selecting the sound quality

Factory settings

Factory settings of the digital sound preset are as follows:

- "SOUND1": bass +1, treble ± 0
- "SOUND2": bass +3, treble ± 0

- 1 While playing, press MENU.
- 2 Press ◀◀ or ▶▶ repeatedly until "SOUND" appears in the display, and press ENT/▶▶||.
- 3 Press ◀◀ or ▶▶ repeatedly to select "SOUND1", "SOUND2", or "OFF" in the display, and then press ENT/▶▶|| to enter the selection. Selecting "OFF" turns off the digital sound preset function.

Adjusting the sound quality

You can change the preset sound quality. To change the preset sound quality, select "SOUND1" or "SOUND2", the one you want to change, in advance.

- 1 While playing, press MENU.
- 2 Press ◀◀ or ▶▶ repeatedly until "SOUND" appears in the display, and then press ENT/▶▶||.
- 3 Press ◀◀ or ▶▶ repeatedly until "SET" appears in the display, and then press ENT/▶▶||.
- 4 Press ◀◀ or ▶▶ repeatedly until "SOUND1" or "SOUND2" appears in the display, and then press ENT/▶▶||.

The display shows the currently "BASS" sound setting.

- 5 Press ◀◀ or ▶▶ repeatedly to adjust the sound level.

Shows "SOUND1" or "SOUND2" is selected



The sound can be adjusted in 8 steps. (-4, -3, ... ± 0 , ...+2, +3)

- 6 Press ENT/▶▶||. "BASS" is set and the display changes to "TRE" (treble) setting mode.
- 7 Press ◀◀ or ▶▶ repeatedly to adjust the sound level, and then press ENT/▶▶|| to enter the selection. "TRE" (treble) is set. The sound settings are saved and the playback display appears again.

To cancel the procedure
Press MENU.

To return the preceding
settings
Press ■/CANCEL.

Note

When using a digital sound preset, the sound may break or become distorted if the volume is turned up too high, depending on the settings or the track. In this case, change the settings of the sound quality.

What is the group function?

The group function is provided to allow playback of discs with group settings. The group function is convenient for playback of MDs on which several albums or CD singles have been recorded in MDLP (LP2/LP4) mode.

What is a disc with group settings?

The recorder can operate various functions in units of group; that is tracks that have been recorded on a disc as part of separate groups, as shown below.

Before group settings are made

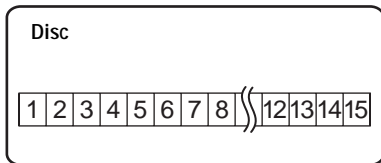

- Track 1 to 5 are assigned to group 1.
- Track 8 to 12 are assigned to group 2.
- Track 13 to 15 are assigned to group 3.
- Track 6 to 7 are assigned to no group.

After setting the group (group play)

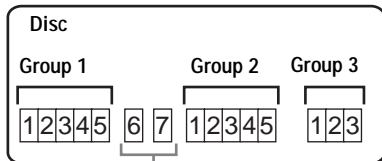

Tracks that were not assigned to a group are treated as being part of "GP --".

You can create a maximum of 99 groups on a disc.

Note

The recorder does not support the recording of group settings on the recorder. Use the supplied SonicStage software to assign tracks to group. For details, see "Software Operation" section (page 32).

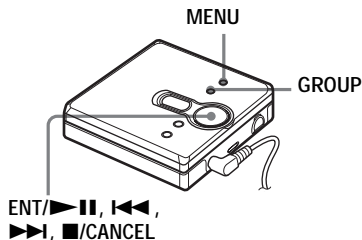

Playing a track in group play

In group play, all groups are played in order, starting with group 1, followed by the unassigned tracks ("GP --"). Playback stops after all the tracks have been played.

- 1 Press MENU.
- 2 Press ◀◀ or ▶▶ repeatedly until "P-MODE" appears in the display, and then press ENT/▶||.
- 3 Press ◀◀ or ▶▶ repeatedly until "☐" and "Normal" appear in the display, and then press ENT/▶||.
- 4 Press ◀◀ or ▶▶ repeatedly until "RepOFF" appears in the display, and then press ENT/▶|| to enter the selection.

To cue to the start of a group (Group Skip)



- 1 While playing, press GROUP.
- 2 Press ◀◀ or ▶▶.
Pressing the ◀◀ or ▶▶ button cues to the first track of the previous or next group.

Selecting the play mode for group play (Group Play Mode)

The shuffle play and repeat play function can be used during group play mode.



- 1 Press MENU.
- 2 Press **◀◀** or **▶▶** until “P-MODE” appears in the display, and then press ENT/▶▶.
- 3 Press **◀◀** or **▶▶** repeatedly to select the play mode, and then press ENT/▶▶.

After normal playback (page 18), the following play modes are displayed.

Display	Play mode
 , Normal (Normal Group Play)	All tracks in the groups play back once (starting with the first track in group 1).
 , Shuff (In-Group Shuffle)	Shuffle play starts with the group that is currently playing, and continues with the succeeding groups.

- 4 Press **◀◀** or **▶▶** repeatedly until “RepOFF” or “RepON” appears in the display, and then press ENT/▶▶ to enter the selection.

If you select “RepON”, “↶” appears in the display and playback repeats in the respective group play mode (Group Repeat Play).

Display	Play mode
 , ↶	Repeat play of tracks within a group
 , SHUF ↶	Repeat shuffle play of tracks within a group

To cancel the procedure
Press MENU.

To return the preceding settings

Press **■**/CANCEL.

Viewing various information

You can check the track name, disc name, etc. during playback. Group-related items appear only when a track with group settings is played.

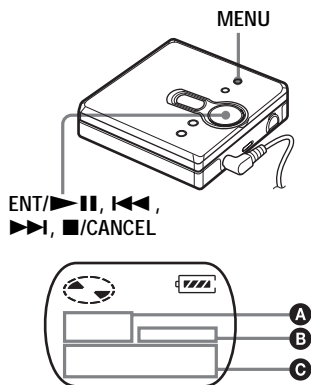

A	B	C
Track number	—	The elapsed time
Track number	♪	Track name
The number of total tracks in the groups	GP	Group name
The number of total tracks	🎵	Disc name
Track number	—	Track mode

- 1 Press MENU.
- 2 Press ◀◀ or ▶▶ repeatedly until “DISP” appears in the display, and then press ENT/▶||.

- 3 Press ◀◀ or ▶▶ repeatedly until the information that you want appears in the display, and then press ENT/▶|| to enter the selection.

Each time you press ▶▶, the display changes as follows:

Display	Meaning
LapTim	The elapsed time of the current track
T:Name	Track name
G:Name	Group name
D:Name	Disc name
T-MODE	Indicates the recording mode selected on the MD recorder used; i.e., “SP”, “LP2”, “LP4”, or “MONO”.

Notes

- Depending on the group settings, the operating conditions and the disc settings, you may not be able to select certain indications or the indications may appear differently.
- The “T-MODE” indication appears only during playback. It appears for a few seconds, and is then replaced by the elapsed time of the current track.

To cancel the procedure
Press MENU.

To return the preceding settings
Press ■/CANCEL.

Starting the playback quickly (Quick Mode)

After pressing the playback button or cueing to the track, the playback can start quickly.

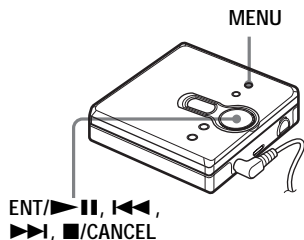

- 1 Press MENU.
- 2 Press ◀◀◀ or ▶▶▶ repeatedly until "OPTION" appears in the display, and then press ENT/▶▶||.
- 3 Press ◀◀◀ or ▶▶▶ repeatedly until "Power" appears in the display, and then press ENT/▶▶||.
- 4 Press ◀◀◀ or ▶▶▶ repeatedly until "QUICK" appears in the display, and then press ENT/▶▶||.

To switch back to the normal setting

Select "NORMAL" in step 4.

To cancel the procedure

Press MENU.

To return the preceding settings

Press ■/CANCEL.

Notes

- When the power mode is set to "QUICK", the power remains on within the recorder even when nothing appears in the display. This leads to a shorter battery life.
- If no recorder operation (including opening or closing of the lid) occurs for an hour, the power in the recorder automatically turn off. For this reason, the next time you start playback or do another operation, the recorder will not respond quickly. The unit, however, will return to quick mode afterwards.

Protecting your hearing (AVLS)

The AVLS (Automatic Volume Limiter System) function keeps down the maximum volume to protect your ears.

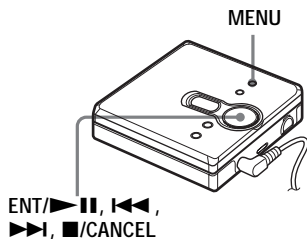

- 1 Press MENU.
- 2 Press ◀◀ or ▶▶ repeatedly until "OPTION" appears in the display, and then press ENT/▶▶||.
- 3 Press ◀◀ or ▶▶ repeatedly until "AVLS" appears in the display, and then press ENT/▶▶||.
- 4 Press ◀◀ or ▶▶ repeatedly until "ON" appears in the display, and then press ENT/▶▶|| to enter the selection.
"ON" appears in the display, and after a few seconds, the playback display appears again.

To cancel the AVLS function
Select "OFF" in step 4.

To cancel the procedure
Press MENU.

To return the preceding settings
Press ■/CANCEL.

Locking the controls (HOLD)

To prevent the buttons from being accidentally operated when you carry the player, use this function.

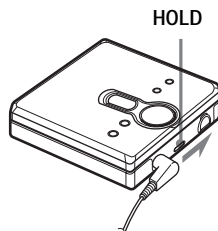

- 1 Slide HOLD in the direction of the  to lock.

To unlock the controls
Slide HOLD to the opposite direction of the arrow.

Precautions

On safety

- Do not carry or store the dry battery in the same place with metallic objects such as coins, key rings, or necklaces. This may cause a short-circuit and the generation of heat.
- Incorrect battery usage may cause the battery fluid to leak or battery to burst. To prevent such accidents, make sure the battery is installed with the + and – poles oriented correctly.
- If a battery leak should develop, carefully and thoroughly wipe away the battery fluid in the battery compartment before inserting a new battery.
- If you will not use the recorder for a long time, be sure to remove the dry battery.

On Handling

- Do not drop or bump the recorder. This may cause the recorder to malfunction.
- Do not pull headphones/earphones cords.
- Do not place the recorder in the following places:
 - An extremely hot place (over 60°C (140°F))
 - A place exposed to direct sunlight or near a heater
 - In a car with the windows rolled up (especially in the summer)
 - In a damp place such as a bathroom
 - Near a source of electromagnetic fields such as a magnet, speaker, or TV
 - In a dusty place

On heat build-up

Heat may build up in the recorder if it is used for an extended period of time. This, however, is not a malfunction.

On mechanical noise

The recorder emits mechanical noise while operating, which is caused by the power-saving system of the recorder. This is not a malfunction.

On installation

Never use the recorder where it will be subjected to extremes of light, temperature, moisture or vibration.

On the MiniDisc cartridge

- Do not touch the internal disc directly. Forcing the shutter open may damage the internal disc.
- When transporting a MiniDisc, keep it in its case.
- Do not place the cartridge where it will be subjected to light, temperature, moisture or dust.
- Do not affix the label outside of the specified area on the MD. Make sure the label is placed within the recessed space on the disc.

On the headphones/earphones

Road safety

- Do not use headphones/earphones while driving, cycling, or operating any motorized vehicle. This may lead to a traffic accident and is illegal in many areas. It can also be potentially dangerous to play your recorder at high volumes while walking, especially at pedestrian crossings. You should exercise extreme caution or discontinue using the recorder in potentially hazardous situations.
- If you experience an allergic reaction to the supplied headphones/earphones, stop using them at once and consult a doctor or a Sony service center.

Preventing hearing damage

Avoid using headphones/earphones at high volumes. Hearing experts advise against continuous, loud and extended play. If you experience a ringing in your ears, reduce the volume or discontinue use.

Caring for others

Keep the volume at a moderate level. This will allow you to hear outside sounds and to be considerate of the people around you.

On cleaning

- After wiping the recorder casing with a soft cloth slightly moistened with water, wipe it again with a dry cloth. Do not use any type of abrasive pad, scouring powder or solvent such as alcohol or benzene as this may mar the finish on the casing.
- Wipe the disc cartridge with a dry cloth to remove dirt.
- Dust on the lens may prevent the unit from operating properly. Be sure to close the disc compartment lid after inserting or ejecting an MD.
- To maintain good sound quality, use a soft cloth to clean the plugs of the headphones/earphones. A dirty plug may cause noise or intermittent breaks in the sound during playback.
- Clean the terminals periodically with a cotton swab or a soft cloth as illustrated.

Dry battery compartment

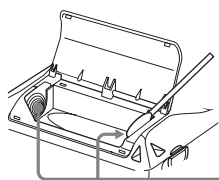

Terminals

To protect a recorded MD

To record-protect an MD, slide open the tab at the side of the MD. In this position, the MD cannot be recorded. To record again, slide the tab back so the tab is visible.

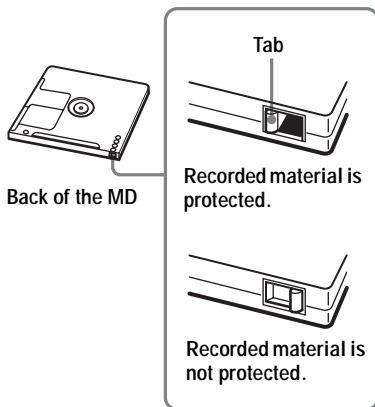

If you have any questions or problems concerning your recorder, please consult your nearest Sony dealer. (If a trouble occurred when the disc was in the recorder, we recommend that the disc be left in the recorder when you consult your Sony dealer so that the cause of trouble may be better understood.)

When consulting your Sony dealer, be sure to bring the recorder and the headphones/earphones.

Specifications

MD Player

Audio playing system

MiniDisc digital audio system

Laser diode properties

Material: GaAlAs

Wavelength: $\lambda = 790 \text{ nm}$

Emission duration: continuous

Laser output: less than 44.6 μW

(This output is the value measured at a distance of 200 mm from the objective lens surface on the optical pick-up block with 7 mm aperture.)

Recording and playback time (when using MDW-80)

Maximum 160 min. in monaural

Maximum 320 min. in LP4 stereo

Revolutions

Approx. 380 rpm to 2,700 rpm

Error correction

ACIRC (Advanced Cross Interleave Reed

Solomon Code)

Sampling frequency

44.1 kHz

Coding

ATRAC (Adaptive TRansform Acoustic Coding)

ATRAC3 — LP2/LP4

Modulation system

EFM (Eight to Fourteen Modulation)

Number of channels

2 stereo channels

1 monaural channel

Frequency response

20 to 20,000 Hz $\pm 3 \text{ dB}$

Outputs

Ⓜ: stereo mini-jack, maximum output level

5 mW + 5 mW, load impedance 24 Ω (USA)

5 mW + 5 mW, load impedance 16 Ω (Canada)

General

Power requirements

One LR6 (size AA) alkaline battery (not supplied)

Recommended temperature for check-in/check-out

+5 °C (+41°F) or higher

Battery operation time

See "Battery life" (page 14)

Dimensions

Approx. 81 × 28.9 × 74.4 mm (w/h/d) (3¹/₄ × 1³/₁₆ × 3 in.) without projections.

Mass

Approx. 106 g (3.8 oz) the recorder only

US and foreign patents licensed from Dolby Laboratories.

Design and specifications are subject to change without notice.

Optional accessories

MDR series stereo Headphones/earphones*

SRS series Active Speakers

- * When using optional headphones, use only headphones/earphones with stereo mini plugs. You cannot use headphones/earphones with micro plugs.

Your dealer may not handle some of the above listed accessories. Please ask the dealer for detailed information about the accessories in your country.



Troubles and solutions

If you find any troubles operating the recorder, follow the steps below.

- 1 Check this section, “Troubles and solutions” (page 29).
- 2 If you cannot solve the problem after you made checks, consult your nearest Sony dealer.

While playing

Symptom	Cause/Remedy
An MD is not played normally.	<ul style="list-style-type: none">• Repeat play is selected. ➔ Use MENU on the recorder to change back to the normal play (page 18).• Playback mode is changed. ➔ Use MENU on the recorder to change back to the normal play (page 18).
An MD is not played from the first track.	<ul style="list-style-type: none">• Disc playing stopped before it came to the last track. ➔ Press ► for 2 seconds or more to start playing.• Group play mode is selected. ➔ Use MENU on the recorder to change back to the normal play (page 18), and then press ► for 2 seconds or more to start playing.
The digital sound preset function does not work.	<ul style="list-style-type: none">• The digital sound preset is off. ➔ Select “SOUND1” or “SOUND2” (page 19).
Playback sound skips.	<ul style="list-style-type: none">• The recorder is placed where it receives continuous vibration. ➔ Put the recorder on a stable place.• A very short track may cause sound to skip. ➔ Try not to create a track under one second long.
Sound has a lot of static.	<ul style="list-style-type: none">• Strong magnetism from a television or such device is interfering with operation. ➔ Move the recorder away from the source of strong magnetism.
Noise is momentarily heard.	<ul style="list-style-type: none">• The sound was recorded in LP4 stereo mode. ➔ Because of the nature of the compression method used in LP4 mode, noise may be output on very rare occasions during playback of sound recorded in this mode.
Volume cannot be turned up.	<ul style="list-style-type: none">• AVLS is on. ➔ Release AVLS settings (page 25).

Symptom	Cause/Remedy
No sound comes through the headphones/earphones.	<ul style="list-style-type: none"> The headphones/earphones plug is not firmly connected. ➔ Plug in the plug of the headphones/earphones firmly to . Volume is too low. ➔ Adjust the volume by pressing VOL + or -. The plug is dirty. ➔ Clean the plug.
The recorder skips to several tracks ahead or behind when you press ⏮ or ⏭ .	<ul style="list-style-type: none"> The GROUP button has been pressed ( is flashing in the display). ➔ The recorder returns to normal if no operation has made for 5 seconds.
The edited tracks may exhibit sound dropout during search operations.	<ul style="list-style-type: none"> This occurs due to the MiniDisc system limitation. The fragmentation of data may cause sound dropout while searching because the tracks are played in higher speed than normal playback.

While using group function

Symptom	Cause/Remedy
The group function does not operate.	<ul style="list-style-type: none"> While using a disc with no group setting, an attempt was made to select some group-related menu (“No Gp” appears in the display). ➔ Use a disc with group setting.
A track cannot be checked out to a new group. A new group cannot be created on the supplied SonicStage software.	<ul style="list-style-type: none"> This is due to the MiniDisc system limitations. Group information has been written to the area where the disc name is stored. The disc name and track names are recorded in the same area, which can store a maximum of approximately 1,700 characters. If the total number exceeds this amount, a new group cannot be created even though group mode is on. It is also impossible to make group settings at this time.

Others

Symptom	Cause/Remedy
The recorder does not work or works poorly.	<ul style="list-style-type: none"> The volume is low. ➔ Turn up the volume. No disc is inserted (“NoDISC” appears in the display). ➔ Insert a recorded disc.

<p>The recorder does not work or works poorly.</p>	<ul style="list-style-type: none"> • The HOLD function is turned on (“HOLD” appears in the display when you press an operation button on the recorder). <ul style="list-style-type: none"> ➔ Disable HOLD by sliding the HOLD switch to the opposite direction of the arrow. • The lid is not firmly closed. <ul style="list-style-type: none"> ➔ Close the lid until it clicks. • Moisture has condensed inside the recorder. <ul style="list-style-type: none"> ➔ Take the MD out and leave the recorder in a warm place for several hours until the moisture evaporates. • The dry battery is weak (“LoBATT” flashes or nothing appears). <ul style="list-style-type: none"> ➔ Replace the dry battery with a new one. • The dry battery have been inserted incorrectly. <ul style="list-style-type: none"> ➔ Insert the battery correctly. • An MD with nothing recorded on is inserted (“BLANK” appears in the display). <ul style="list-style-type: none"> ➔ Insert a recorded MD. • The disc is damaged or does not contain proper recording (“Rd ERR” appears in the display). <ul style="list-style-type: none"> ➔ Reinsert the disc. If the error message still appears, replace it with another disc. • While operating, the recorder received a mechanical shock, too much static, abnormal power voltage caused by lightning, etc. <ul style="list-style-type: none"> ➔ Restart the operation as follows. <ol style="list-style-type: none"> 1 Remove the dry battery from the recorder. 2 Leave the recorder for about 30 seconds. 3 Insert the dry battery.
--	--

Explanations

About the DSP TYPE-S for ATRAC/ATRAC3

This recorder supports playback with the DSP TYPE-S specification for high-level Sony MiniDisc decks equipped with digital signal processors (DSP). This specification allows tracks recorded in MDLP mode to be played back with high quality sound. Since this recorder also supports DSP TYPE-R specification, superb sound is produced during playback in SP (normal stereo) mode as well.

Suppressing the skips of the sound (G-PROTECTION)

The G-PROTECTION function was developed to provide a higher level of shock resistance than that of existing players.

Recording audio data to your computer

You can record audio data to your computer from sources such as audio CDs and the Internet (page 40).



Audio CDs



Internet



On the computer

Listening

You can listen to an audio CD in the CD-ROM drive of your computer, or audio data in the hard disk drive (page 47).



What is a Net MD?

Net MD is a standard that enables the transfer of audio data from a computer to a MiniDisc device. To use this Net MD with your computer requires a software application called “SonicStage”.

SonicStage software provides a database for managing audio data in the computer and functions for playing the audio data in various play modes, editing the data, and transferring the results to other devices and hardware connected to the computer. It is an integrated software application with a variety of functions for enjoying music.

Transferring audio data to the Net MD

You can transfer audio data stored in your computer to an MD (page 44).

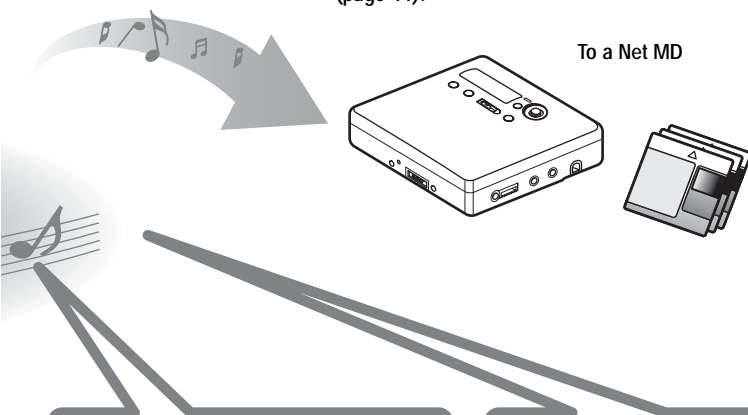

Editing

You can easily edit audio data or add labels from the keyboard (page 43).



Creating a music library

You can create a music library of your favorite songs on your computer.



Basic operational flow using the Net MD

The following is the basic steps that you will take following the purchase of your recorder. Through these steps, you will prepare and set up your computer for use of your recorder as a Net MD. Do the following steps, and refer to the indicated pages for details.

1 Providing the required system environment.

(page 35)

2 Installing the software onto your computer.

(page 36)

3 Connecting the Net MD to your computer.

(page 39)

4 Storing audio data to your computer.

In this manual, recording from an audio CD is explained.

(page 40)

5 Transferring audio data from your computer to an MD (Check-out).

(page 44)

6 Listening to an MD.

You can listen to audio data that have been checked out from your computer to your Net MD.

(page 47)

Providing the required system environment

System requirements

The following hardware and software are required in order to use the SonicStage software for the Net MD.

Computer	IBM PC/AT or Compatible
	<ul style="list-style-type: none">• CPU: Pentium II 400 MHz or higher (Pentium III 450 MHz or higher is recommended.)• Hard disk drive space¹⁾: 120 MB or more• RAM: 64 MB or higher (128 MB or higher is recommended)
	Others
	<ul style="list-style-type: none">• CD-ROM drive (capable of digital playback by WDM)• Sound Board• USB port (supports USB 2.0 Full Speed (previously USB 1.1))
Operating System	Factory installed: Windows XP Home Edition/Windows XP Professional/Windows Millennium Edition/Windows 2000 Professional/Windows 98 Second Edition
Display	High Color (16bit) or greater, 800 × 480 dots or more (800 × 600 dots or more is recommended)
Others	<ul style="list-style-type: none">• Internet access: for Web registration and EMD services• Windows Media Player (version 7.0 or higher) installed for playing WMA files

¹⁾ See page 53 for details.

This software is not supported by the following environments:

- Macintosh
- Windows XP versions other than Home Edition or Professional
- Windows 2000 versions other than Professional
- Windows 98 versions other than Second Edition
- Windows NT
- Windows 95
- Personally constructed PCs or operating systems
- An environment that is an upgrade of the original manufacturer-installed operating system
- Multi-boot environment
- Multi-monitor environment

Notes

- We do not ensure trouble-free operation on all computers that satisfy the system requirements.
- We do not ensure trouble-free operation of the system suspend, sleep, or hibernation function on all computers.

Installing the software onto your computer

This section explains the installation of the SonicStage Ver.1.5 software supplied with your Net MD.

Before installing the software

1 Make sure to note the following before installing the software.



Do not connect the dedicated USB cable before the installation!

The SonicStage software may not correctly load or operate if the dedicated USB cable is connected to your computer during the installation.



Close all other Windows applications before starting the installation!

Make sure to close any virus-check software, as such software usually demand large amounts of system resources.

2 Depending on the following operating system or software already installed on your computer, refer to the reference pages before installing the software.

Windows XP → page 50	<ul style="list-style-type: none">• To install this software, you must log on with a user name with “Computer Administrator”.• If you perform the “System Restore” function in the Windows “System Tools” menu, the tracks managed by SonicStage may become corrupted and rendered unplayable.
Windows Millennium Edition → page 51	<ul style="list-style-type: none">• If you perform the “System Restore” function of the Windows “System Tools” menu, the tracks managed by SonicStage may become corrupted and rendered unplayable.
Windows 2000 → page 51	<ul style="list-style-type: none">• You must log on as “Administrator” before installing the software.
OpenMG Jukebox, SonicStage, or SonicStage Premium → page 52	<ul style="list-style-type: none">• Depending on the version of your software, the existing software may be overwritten by the new version or it may co-exist with SonicStage Ver.1.5. As the installation process will depend on the version, see the reference page for details.

Installing SonicStage Ver.1.5

1 Turn on your computer and start up Windows.

2 Insert the installation CD-ROM for SonicStage into the CD-ROM drive of your computer.

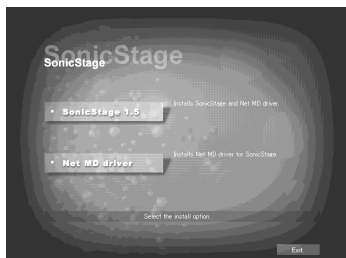

The setup program starts up automatically and the SonicStage Ver.1.5 installation window appears.

3 Click to select [SonicStage 1.5].

To use this software with the Net MD, you must install SonicStage Ver.1.5 and the Net MD driver.

Click [SonicStage 1.5]

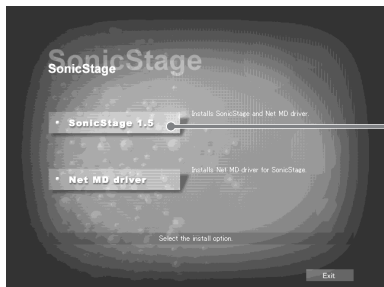

- When installing SonicStage for the first time
- When SonicStage, SonicStage Premium, or OpenMG Jukebox is installed on the computer

continued

4 Follow the displayed instructions.

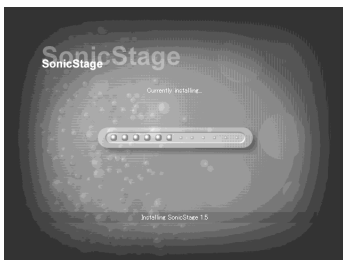

Read the instructions carefully. The installation may take 20 to 30 minutes, depending on your system environment (page 59).

5 After the installation is completed, click [Restart] to restart the computer.

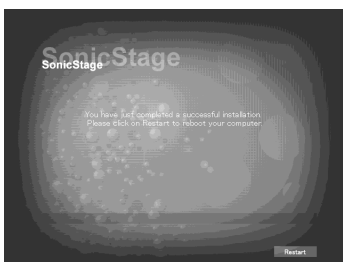

Make sure to restart your computer only after the installation has completed.

Was the installation successful?

If any trouble occurs during the installation, see “Troubleshooting” (page 56).

Notes

- Do not delete, move, or edit any of the installed folders using Explorer or any other application. Doing so could cause the SonicStage database to become unstable or corrupted.
- While the installation is still in progress, do not interrupt the operation or take the CD-ROM out of the CD-ROM drive. Doing so may render it impossible to install the software thereafter.

Connecting the Net MD to your computer

After the software installation is completed, connect the Net MD to your computer. Refer to the operating instructions of the Net MD as well.

- 1 Make sure the remaining power of the dry battery is sufficient.

Note

Disconnect the dedicated USB cable before replacing the dry battery.

- 2 Insert a recordable disc into the Net MD.
-

- 3 Make the power source and the dedicated USB cable connections with the Net MD and the computer.

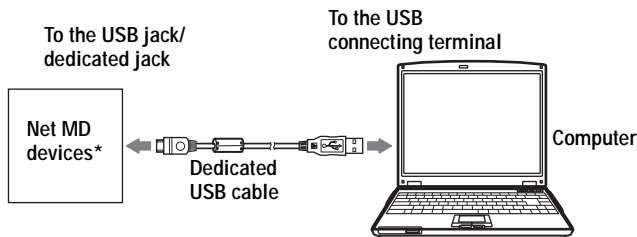

* If a cradle is supplied with your Net MD, connect the dedicated USB cable to the USB cradle and place the Net MD onto the USB cradle.

- 4 Check the connections.

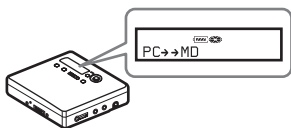

When the connections have been properly made, "PC→MD"* appears in the display of the Net MD.

*Depending on the device, "Net MD" may be displayed.

Notes

- When using the Net MD connected to your computer, make sure to run the recorder with a new dry battery. We do not assure the results should there be a mis-operation, check-out failure, or destruction of audio data caused by insufficient battery power.
- Place the recorder on a stable surface so that the dedicated USB cable does not become detached.

Storing audio data to your computer

This section explains how to record and store audio data from an audio CD to the hard disk drive of your computer.

The procedure in this section is used to record all tracks on an audio CD. To record only specific tracks from a CD, or from other sound sources, see the online help for details (page 48).

Note

The system may malfunction if your computer changes to system suspend or hibernation mode while the software is playing, recording, or connecting to an external device or media* such as a Net MD. Make sure to disable any changes to suspend or hibernation mode. See page 53 for details.

* For this software, the word “MD” refers to the built-in MD slot on the computer, and “Device/ Media” to a Net MD that is externally connected over a USB cable.

Starting SonicStage

Do one of the following:

- Double click  ([SonicStage] icon) on the computer.
- Select [Start] - [Programs]* - [SonicStage] - [SonicStage].

* [All Programs] in the case of Windows XP

SonicStage starts up and the main window appears.

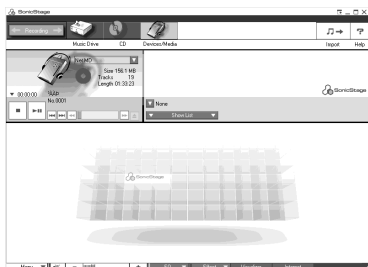

Recording audio CDs to the hard disk drive

In SonicStage Ver.1.5, the hard disk drive is called the “Music Drive”. The Music Drive manages all audio data stored by SonicStage.

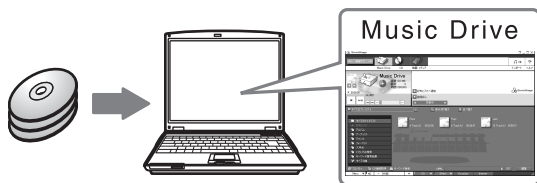

- 1 Insert the audio CD that you want to record into the CD-ROM drive of your computer.



The CD window appears in the display.

Note

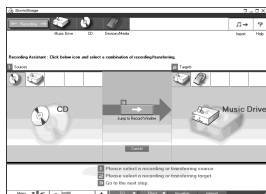

When you record an audio CD from your CD-ROM drive for the first time, the “CD Drive Optimization” dialog box appears when you insert the audio CD. Clicking [Start] initiates a check of the CD-ROM drive to verify that the CD-ROM drive is able to perform the recording properly.

- 2 Click .



The recording navigation window* appears in the display.

*The recording navigation window makes it easy to make a recording. Simply by doing **1**, **2** and **3** in the next step, you can select the audio source in the left panel and the recording destination in the right panel.

- 3 Select  (CD) for [**1** Sources] and  (Music Drive) for [**2** Targets], then click **3**  [Jump to Record Window].

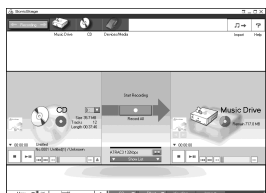

The display changes to the recording window.

-
- 4 Click **ATRAC3 132kbps**  in the middle of the recording window and select the recording mode.

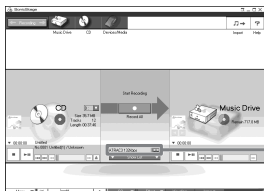

When recording data in LP2 mode:
select ATRAC3 132kbps

When recording data in LP4 mode:
select ATRAC3 66kbps

-
- 5 If the list panel is not displayed, click .



List panels appear under the recording window. The contents of the audio CD appear in the left list panel.

-
- 6 Click  [Record All].

Recording starts.

Upon completion, recorded tracks appear in the right list panel.

To stop recording

Click  ([Stop]).

To resume recording, click . When recording is resumed, it starts from the beginning of the track that was last stopped.

Labeling audio data

After recording has completed, you can label the audio data in the Music Drive. Once audio data in the Music Drive is labeled, the label information will be transferred to a disc along with the audio data, allowing you to view the data on your Net MD.

- 1 Start up SonicStage (page 40) and click  (Music Drive).



“All Playlists” appears and all the albums stored on the Music Drive appear in the Music Drive window.

- 2 Double click the desired album name.

A list of the audio files in that album appears.

- 3 Click  in the lower right part of the display.

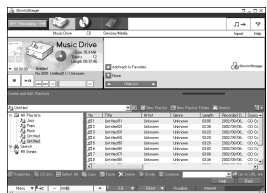



The editing panel appears in the display.

- 4 Select an item by clicking [Title], [Album], [Artist], or [Genre], and then right-click and select [Rename].

You can also click [▼] at [Album] or [Artist] to display a dropdown list, and then select an item from the list.

- 5 When the track title is highlighted, enter the text data from the keyboard.
-

 You can also import names from a database with the  ([CD Info]) button for use in labeling tracks or albums. See the online help for details (page 48).

Transferring audio data from your computer to the Net MD (Check-out)

Audio data stored on the Music Drive can be transferred to your Net MD. This process is called “Check-out”. The number of times a track can be checked out is restricted in this software for the protection of copyrights (page 61).



Checking out audio files to the Net MD

This section explains how to check out all audio files in a playlist*.



- * A playlist is a container that allows the stored audio files in the Music Drive to be classified by genre, artist, etc.

Notes

- Make sure the remaining power of the dry battery is sufficient.
- Check-outs should be done at a temperature of +5 °C (+41 °F) or higher.

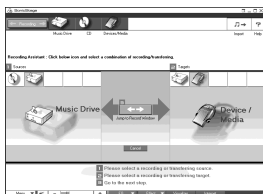
1 Click  to display the recording navigation window.



2 Select  (Music Drive) for [1 Sources] and  (Device/Media) for [2 Targets], then click  ([Jump to Record Window]).
The display changes to the recording window.

-
- 3 Click **Normal**  in the middle of the display and select the recording mode (page 42).

Standard transfer mode: Data are transferred in the format of the original files.

Maximum available transfer space: All data are transferred in LP4 mode.

SP transfer mode: All data are converted and transferred in normal stereo mode. Select this mode if you listen to checked-out data on equipment that does not support MDLP mode.



- 4 If the list panel is not displayed, click **Show List**  .

A playlist appears in the display.



-
- 5 Confirm that the audio files you are about to check out are okay for checking out.



The music notations beside the track number in the left panel of the list represent the number of times the file can be checked out (e.g.  = the track can be checked out three more times). If  appears beside the track number, the file cannot be checked out.

-
- 6 Click  [Check-Out All].

Checking out of the files starts.

All files in the playlist are checked out to the connected Net MD.

To cancel a check-out

Click  ([Stop]).

Notes

- Make sure the battery power is sufficient before checking out (or checking in) audio data. If the battery becomes exhausted during a check-out (or check-in), the check-out (or check-in) will not be completed. If this happens, replace the dry battery with a new one and try again.
- Make sure not to disconnect the dedicated USB cable or power source until the operation has completed once the check-out (or check-in) operation has begun. Failure to do this may result in the loss of check-out authorization. Even if a check-out fails, the audio file may be considered checked out on the SonicStage side and the file's check-out authorization may be reduced.
- Make sure not to bump the Net MD after check-out has started. If you do, the contents of the recording may not be stored correctly.
- Due to the limitations of the MD system, you may not be able to record the full amount of remaining recording time.
- Due to the limitations of the MD system, a maximum of about 1,700 characters can be stored for disc name, group names and track names on the disc. Take note of this fact when checking out a large number of tracks.
- The checking out of audio data may take longer if the battery is weak.

Listening to an MD

You can listen to an MD on the Net MD while it is connected to your computer. When disconnected from your computer, the Net MD can be used as an ordinary MiniDisc device.

For details on Net MD operations, refer to the “Recorder Operations” section.

Listening to an MD with the Net MD connected to the computer

If you listen to an MD with the Net MD connected to the computer, be sure to listen with the Net MD itself (connecting to the headphones/earphones, speakers, etc.). The MD sound cannot be heard from headphones/earphones that are connected to the computer.

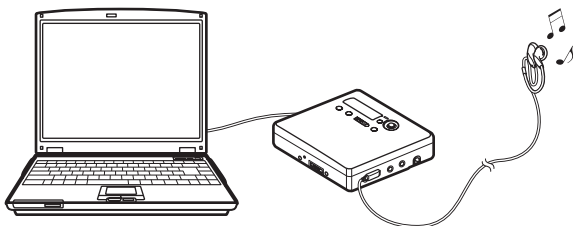

Listening to an MD with the Net MD disconnected from the computer

Listen to the MD after disconnecting the dedicated USB cable from the computer and the Net MD.

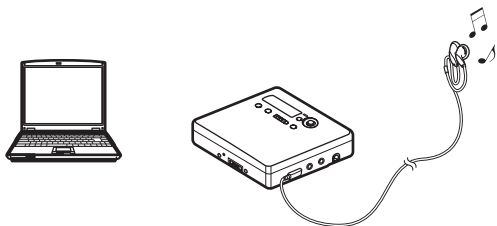

Notes

Generally, you cannot erase or divide/combine checked-out audio files. If you want to edit such files, check them back in first. Checked-out files can be edited on some MD devices; however, erasing a track will decrease the number of times the file can be checked out, and dividing or combining tracks will render the file impossible to check back into the computer (page 60).

Using other functions!

Using the SonicStage online help

This manual explains only the basic operations of the SonicStage software. However, the software has a host of other functions that allow you to carry out various operations, such as importing audio files from the Internet, classifying and managing audio files, and playing in various play modes. For information and details on the various menus and operations, go to the online help.

To display online help

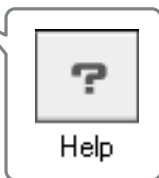

Click  (help) while the SonicStage software is running.



You can display the online help by selecting the following:
[Start]–[Programs]*–[SonicStage]–[SonicStage Help]

* [All Programs] in the case of Windows XP.

Viewing online help

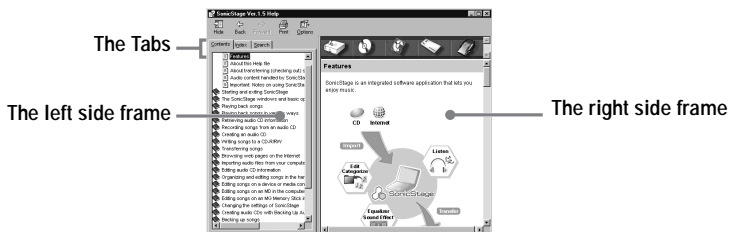

Let's find out how to use the online help first. An explanation on the use of the online help can also be found in the online help.

1 Double click [Overview] in the left-hand frame.

2 Click [About this Help file].

The explanation will appear in the right-hand frame.

3 Read the text.

Scroll the display if necessary.

Click underlined words to jump to their explanations.

Note

In the online help, "Device/Media" is the general term for external devices such as Net MDs, Network Walkmans (i.e., portable IC audio players or portable "Memory Stick" audio players), and MusicClips.

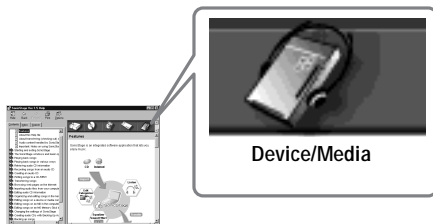

Settings and Precautions

Settings according to OS

The settings and precautions will differ according to the operating system being used. Check the items that apply to your system.

 For Windows XP users

Restrictions when running the SonicStage software under Windows XP

- To install this software, you must log on with a user name with “Computer Administrator”* as an attribute.
- You must log on with the user name “Administrators” or “Power Users” to use the SonicStage software.
- Both edition of Windows XP (Home/Professional) can be used.
- The NTFS format of Windows XP Home Edition or Windows XP Professional (factory installed) can be used only with the standard (factory) settings.

* To check whether the user name has the attribute of “Computer Administrator”
Go to [Start]- [Control Panel]-[User Account], and then check the user name displayed on the window.

When using SonicStage under Windows XP

If you use the “System Restore” function in Windows “System Tools”, audio data managed by SonicStage may become corrupted and rendered unplayable.

Before executing the system restoration procedure, you should first back up all audio files and restore them after doing the system restoration procedure.

For details about backup procedures, refer to online help.

Note

Restoring backup data requires access to the Internet. If an audio file becomes unplayable after restoring the system, an error dialog box may appear. If this occurs, do as instructed by the message.

 For Windows Millennium Edition users

When using SonicStage under Windows Millennium Edition

If you use the “System Restore” function in Windows “System Tools”, audio data managed by SonicStage may become corrupted and rendered unplayable.

Before executing the system restoration procedure, you should first back up all audio files and restore them after doing the system restoration procedure.

For details about backup procedures, refer to online help.

Note

Restoring backup data requires access to the Internet. If an audio file becomes unplayable after restoring the system, an error dialog box may appear. If this occurs, do as instructed by the message.

 For Windows 2000 users

Restrictions when running the SonicStage software under Windows 2000

- You must log on as “Administrator” to install the SonicStage software.
- You must log on with the user name “Administrators” or “Power Users” to use the SonicStage software.
- Of the Windows 2000 versions, SonicStage is supported only by Windows 2000 Professional.
- The NTFS format of Windows 2000 Professional (factory installed) can be used only with the standard (factory) settings.

 For Windows 98 Second Edition users

Importing MP3 files to the computer or playing WAV files on the computer

Microsoft Media Player version 7.0 or higher is required for importing MP3 files or playing WAV files. Users of earlier versions can download the most recent version from the Microsoft website (<http://www.microsoft.com/>).

For users with OpenMG Jukebox, SonicStage, or SonicStage Premium installed on their computer

Note

Confirm whether any tracks have been checked out from your computer. If tracks have been checked out from OpenMG Jukebox, an earlier version of SonicStage, or SonicStage Premium, it may not be possible to check those tracks back in with SonicStage Ver.1.5. It is recommended to check in the tracks before installing SonicStage Ver.1.5.

Check the following contents before installing SonicStage Ver.1.5.

The installation items and procedure will vary depending on the software installed on your computer.

Users with OpenMG Jukebox installed

Installed Version	What to do
Ver.1.0~2.1	Install SonicStage 1.5. OpenMG Jukebox Ver.1.0-2.1 is automatically uninstalled and replaced. ¹⁾
Ver.2.2	OpenMG Jukebox Ver.2.2 and SonicStage Ver.1.5 can co-exist in the computer. If you install SonicStage Ver.1.5, then OpenMG Jukebox Ver.2.2 will be automatically upgraded to the latest version.

- ¹⁾ Audio files recorded with OpenMG Jukebox Ver.1.0-2.1 are automatically converted to SonicStage Ver.1.5 files. For safety sake, it is recommended that you back up your audio data with the back-up tool before doing the upgrade to SonicStage Ver.1.5.

Users with an earlier version of SonicStage installed

Installed Version	What to do
Ver.1.0~1.5	Install SonicStage Ver.1.5. The earlier version is automatically uninstalled and replaced. ¹⁾

- ¹⁾ Audio files recorded with SonicStage Ver.1.0-1.5 are automatically converted to SonicStage Ver.1.5 files. For safety sake, it is recommended that you back up your audio data with the back-up tool before doing the upgrade to SonicStage Ver.1.5.

Users with a SonicStage Premium installed

Installed Version	What to do
SonicStage Premium	Install SonicStage Ver.1.5. SonicStage Ver.1.5 and SonicStage Premium can co-exist in the computer.

Precautions on the co-existence of SonicStage Ver. 1.5 with OpenMG Jukebox Ver.2.2 or SonicStage Premium

- Make sure the OpenMG Jukebox Ver.2.2 icon is not displayed in the task tray. If it is, the Net MD may not be recognized by your computer.
- Audio data recorded on the computer are stored in a common file and used by both applications. Therefore, if you delete an audio file (e.g., one album) in one application, it will be deleted in the other software as well.

Precaution on using a computer on which OpenMG Jukebox Ver.1.0-2.1 or SonicStage Ver.1.0-1.2 is installed

After installing SonicStage Ver. 1.5, make sure you do not replace SonicStage Ver.1.5 with OpenMG Jukebox Ver.1.0-2.1 or SonicStage Ver.1.0-1.2, as all audio data in the Music Drive may be lost. If you begin the installation of OpenMG Jukebox Ver.1.0-2.1 or SonicStage Ver.1.0-1.2 by mistake, stop the installation immediately.

Note on hard disk drive space

120 MB or more free space on the hard disk drive is required. If your computer does not have enough space, the software will not be properly installed. The required free space differs according to the version of your Windows OS, or the amount of audio files that you handle.

Notes on system suspend/hibernation mode

- If the computer changes to system suspend/hibernation mode during the recording of a CD or the checking in/out of a data file, the audio data may be lost or the computer may not wake up properly. The computer suspend/hibernation function should therefore be turned off.
- If you change the media while the computer is in system suspend/hibernation mode, audio data may be lost after the computer wakes up.
- If the computer changes to system suspend/hibernation mode, the computer may not recognize the Net MD when it wakes up. If this happens, disconnect the dedicated USB cable and reconnect it again.

Backing up the audio data

Before doing any procedure that may affect the operating system itself (such as a system recovery), you should back up all of your audio data with the [SonicStage backup tool] from the [Start] - [Programs] - [SonicStage].

Note on the battery

- Make sure the battery power is sufficient before checking out (or checking in) audio data. If the battery becomes exhausted during a check-out (or check-in), the check-out (or check-in) will not be completed. If this happens, replace the dry battery with a new one and try again.
- When replacing a dry battery, make sure to disconnect the dedicated USB cable.

Uninstalling the SonicStage software

To uninstall the SonicStage software, follow the procedures below.

For Windows XP users

Log on with a user name with “Computer Administrator” as an attribute. Refer to the operating instructions of your computer for details on logging on as an administrator.

-
- 1 Click [Start]–[Control Panel].
The “Control Panel” window appears.

 - 2 Double-click [Add/Remove Programs].
The “Add/Remove Programs” dialog box appears.

 - 3 Click [Change or Remove Programs].

 - 4 Click [SonicStage 1.5.XX] in the “Currently Installed Programs” list, and then click [Change and Remove].

 - 5 Click [OpenMG Secure Module 3.1]* in the “Currently Installed Programs” list, and then click [Change and Remove].
Do as instructed by the message and restart the computer. When the computer restarts, the uninstallation will be completed.

* If SonicStage Ver.1.5 is co-existing with OpenMG Jukebox Ver.2.2 or SonicStage Premium on your computer, and you uninstall one or the other, make sure [OpenMG Secure Module 3.1] is not uninstalled since it is commonly used with both software applications.

For Windows Millennium Edition/Windows 98 Second Edition users

-
- 1 Click [Start]–[Settings]–[Control Panel].
The “Control Panel” window appears.
-

2 Double-click [Add/Remove Programs].
The Add/Remove Programs Properties window appears.

3 Click [SonicStage 1.5.XX] in the list of programs for automatic removal, and then click [Add/Remove].

4 Click [OpenMG Secure Module 3.1]* in the list of programs for automatic removal, and then click [Add/Remove].
Do as instructed by the message and restart the computer. When the computer restarts, the uninstallation will be completed.

For Windows 2000 users

Log on as “Administrator”, and then follow the instructions below.
Refer to the operating instructions of your computer for details on logging on as an administrator.

1 Click [Start]–[Settings]–[Control Panel].
The “Control Panel” window appears.

2 Double-click [Add/Remove Programs].
The “Add/Remove Programs” dialog box appears.

3 Click [Change or Remove Programs].

4 Click [SonicStage 1.5.XX] in the “Currently Installed Programs” list, and then click [Change/Remove].

5 Click [OpenMG Secure Module 3.1]* in the “Currently Installed Programs” list, and then click [Change/Remove].
Do as instructed by the message and restart the computer. When the computer restarts, the uninstallation will be completed.

* If SonicStage Ver.1.5 is co-existing with OpenMG Jukebox Ver.2.2 or SonicStage Premium on your computer, and you uninstall one or the other, make sure [OpenMG Secure Module 3.1] is not uninstalled since it is commonly used with both software applications.

Troubleshooting

Please do the following steps if you encounter a problem while using the SonicStage software. In case a message appears, it is recommended that you write it down.

Step 1: Check the symptoms in this “Troubleshooting” section.

A variety of information can also be found in the operating procedures and “Settings and Precautions” (page 50) as well.

Step 2: Check the symptoms in the SonicStage 1.5 online help (page 48).

Check “Troubleshooting” under “Additional information” in the online help. Useful information may also be found in other sections in the online help.

Step 3: If the trouble cannot be solved after checking the above references.

Check the following table and then consult your nearest Sony dealer.

Computer <ul style="list-style-type: none"> • Manufacturer: • Model: • Type: Desktop type / Laptop type
Name of operating system:
RAM capacity:
Hard disk drive (containing SonicStage and audio data) <ul style="list-style-type: none"> • Capacity of the drive: • Free space:
Installed folder containing SonicStage (if other than the default folder)¹⁾ <ul style="list-style-type: none"> • Location of the installed folder:
Version of the software (SonicStage Ver.1.5) ²⁾ :
Error Message (if one appeared):
If an externally connected CD-ROM drive is used <ul style="list-style-type: none"> • Manufacturer: • Model: • Type: CD-ROM / CD-R/RW / DVD-ROM / Other () • Type of connection to the computer: PC card / USB / IEEE1394 / Other ()
If another device with USB connection is used <ul style="list-style-type: none"> • Name of the device (or devices):

¹⁾ If you do not specify the destination, the software is installed at C:\Program Files\Sony\SonicStage.

²⁾ To check the SonicStage software version, go to [Menu] - [About SonicStage] in the SonicStage window, or see the version information on the supplied CD-ROM.

If your computer does not recognize the Net MD

- **Is the Net MD connected correctly to your computer?**

- If the Net MD is not firmly connected to the computer, the Net MD will not be recognized by your computer.
- Reconnect the dedicated USB cable. If the computer still does not recognize the Net MD, disconnect the Net MD, restart the computer, and connect the dedicated USB cable again.

- **Is an MD inserted in the Net MD?**

Check if an MD is inserted in the Net MD.

- **If your computer does not recognize your Net MD even when the Net MD is connected and a disc is inserted, the Net MD driver may not be correctly installed.**

Go to the [USB Controller] in the Windows Device Manager window to verify that your Net MD is correctly recognized.

A [!] mark in the Device Manager window indicates that your Net MD is not correctly recognized. Reinstall the Net MD driver.

1 Click [Start]–[Settings]–[Control Panel].¹⁾

2 Double click [System] in the control panel.²⁾

3 Click the [Hardware]³⁾ tab, and then click [Device Manager].

The Device Manager window appears.

¹⁾ In Windows XP, select [Start]–[Control Panel].

²⁾ In Windows XP, double click [System] if the control panel is in the “classic” format, or click [Performance and Maintenance] and then [System] if the control panel is in the “category” format.

³⁾ Depending on your system, the [Hardware] tab may not be provided. In this case, click the [Device Manager] tab to display the Device Manager window.

If the installation was not successful

- **Be sure to close all Windows applications before you start the installation.**

If you start the installation while other programs are running, a malfunction may occur. This is especially true for programs that require large amounts of system resources, such as virus-check software.

- **Be sure not to connect the Net MD to your computer before you start the installation.**

If the dedicated USB cable is connected to your computer before the installation, the installation cannot be done correctly. Connect the dedicated USB cable after the installation completed.

- **Make sure your computer has enough hard disk drive space.**

120MB of free space or more on the hard disk drive is required. If your computer does not have enough space, the installation may not be possible.

- **If the installation seems to be stopped**

It may take 30 minutes or more for the installation to complete, depending on your computer or CD-ROM drive.

During the installation, watch out for the occurrence of any of the following problems.

Problem	Cause/Remedy
The installation appears to have stopped before it has completed.	Check for the appearance of an error message beneath the installation window. → Press the [Tab] key while holding down the [Alt] key. If an error message has appeared, press the [Enter] key. The installation will resume. If there is no message, the installation is still in progress. Wait a little while longer.
The progress bar on the display is not moving. The access lamp has not lit for a few minutes.	The installation is progressing normally. Please wait.

- **If the installation is still unsuccessful after all that you have done.**

— The installation can be done by copying all files to the hard disk as follows:

- 1 Create a new folder on the hard disc.
- 2 Insert the supplied CD-ROM (SonicStage Ver.1.5) into the CD-ROM drive.
- 3 When the installation window appears, click [Exit] to cancel the installation.
- 4 Right-click the start menu and start up Explorer.
- 5 Select [SS15E] on the CD-ROM drive, and then click [Edit] -[Select All].
- 6 Click [Edit]-[Copy to Folder] (or [Edit]-[Copy]) to copy all files to the folder that you created in step 1.
- 7 Remove the CD-ROM from the CD-ROM drive, open the folder that was copied to the hard disk and double-click [setup.exe].
- 8 When the installation window appears, follow the displayed instructions to install [SonicStage 1.5].

— The installation may be done by installing the software from [Start]-[Run].

If check-out (check-in) was not successful

- **Was the battery power sufficient?**

If the battery becomes exhausted during a check-out (or check-in), the check-out (or check-in) will not be completed. In this case, replace the dry battery with a new one and try again.

- **Is the surrounding temperature too low?**

During a check-out (or check-in), make sure the surrounding temperature is +5 °C (+41° F) or higher. If the temperature is low, the recorder's operation will become slow because of the nature of the battery.

Information and explanations

Net MD FAQ

This section introduces frequently asked questions and answers on the Net MD.

On the Net MD

What is a “Net MD”?

Net MD is a specification that allows audio data in a computer to be transferred to a MiniDisc through a USB cable.

Till now, MiniDiscs could be used to record only analog sources (through a microphone or analog input) or PCM sources such as CDs. Recording audio files on a computer was impossible. However, thanks to SonicStage and other music management software based on such copyright protection technology as “OpenMG”¹⁾ and “MagicGate”²⁾, conversion of audio files to the ATRAC or ATRAC3³⁾ format used on MDs became possible, enabling the recording of computer files to MDs.

- 1) Copyright protection technology for managing audio data recorded on computers, etc.
- 2) Technology for verifying the copyright-protection status of audio data in check-out/check-in operations between a computer and a Net MD device.
- 3) File type for recording to an MD.

How does the SonicStage software make using MDs more convenient?

- It allows you to record audio data from your computer to your MD.
- Editing operations are easily done using on-screen operations.
 - Labeling: Allows use of keyboard for easy labeling of contents.
 - Moving tracks or groups: Allows tracks or groups to be moved simply by dragging and dropping. Track movements are easy to see.
 - Group settings: Groups are easy to create or release.

These operations can be used to edit tracks on a disc in the Net MD. If you want to edit the contents of an MD, connect the Net MD to your computer, and edit the tracks in the SonicStage Device/Media window.

Can tracks recorded on the Net MD be checked in to a computer?

No, they cannot.

Audio data that was originally checked out from a computer can only be checked back into the same computer. Tracks that are recorded on the Net MD using a microphone or through an analog or digital connection cannot be transferred to the computer or copied.

Computer ⇔ MiniDisc : OK.

MiniDisc ⇔ Computer : OK only for tracks originally checked out from the computer.

On copyright protection

The OpenMG technology* allows you to enjoy digital music, while maintaining the copyrights of its holders. OpenMG Jukebox encrypts audio files in OpenMG format and stores them on the hard disk of your computer to prevent unauthorized distribution.

* The copyright protection technology of this software conforms to SDMI (Secure Digital Music Initiative) specifications.

This software places some restrictions on recording and playback to protect copyrights.

You can check in audio files only to the same computer from which they were checked out.

They cannot be copied or checked in to other computers.

For details, see “Features by copyright protection by OpenMG” (page 62).

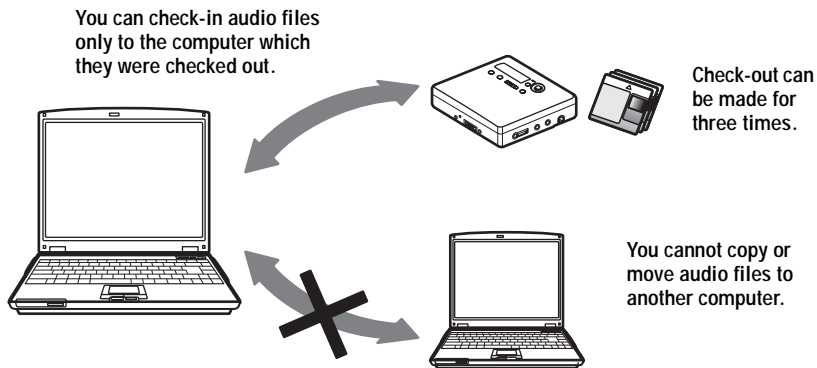

continued

Restrictions on audio content

High-quality digital audio content is widely available through music distribution services on the Internet. To protect the copyrights of its holders from unauthorized distribution, some audio content is distributed with certain restrictions on recording and playback. For example, the playback period or playback count for the data may be limited. In such cases, checking out of the audio contents may not be possible.

Depending on the contents, some audio data that could be checked out are subject to editing restrictions on the Net MD; e.g., audio contents cannot be erased or track marks cannot be added or erased.

It is not possible to check in tracks other than those that were checked out from your computer (for example, tracks recorded using a microphone or through analog or digital connection).

Features by copyright protection by OpenMG

The SonicStage software features OpenMG, a copyright protection technology developed by Sony to protect music copyrights. OpenMG uses high-level cryptographic technology to protect music contents with computers.

Users should be aware of the restrictions described below.

- Music recorded on the hard disk using the SonicStage software cannot be played when copied to other computers.
- Installation of the same SonicStage software to other computers is not permitted.

• Usage Rules

If Usage Rules are included in the music by way of the copyright holder or the distributor, operation will be restricted to use permitted by the Usage Rule. For music, such as compact discs, that does not contain a Usage Rule, the Default Usage Rule of SDMI will apply. This Default Usage Rule states that one file can be checked out up to three times only.

- On music contents that are not compatible with the SonicStage software
Under the supervision of SDMI, this software prohibits recording of music with a copy prohibition signal.
- Upgrading SonicStage software
This software was developed in accordance with the current arrangement between Sony and SDMI. If this arrangement is modified in the future, some of the software functions may become unavailable. Sony may offer an upgrade kit in this case at additional user expense.

Glossary

ATRAC3

ATRAC3, which stands for Adaptive Transform Acoustic Coding³, is audio compression technology that satisfies the demand for high sound quality and high compression rates. The ATRAC3 compression rate is approximately 10 times higher than that of the Audio CD, resulting in an increased data capacity for the media.

“Check-In /Check-Out”

Check-out is to transfer music files from a personal computer to an external device/media (such as a Network Walkman). Returning checked-out music files to the same computer is to check in. (You cannot move checked-out music files to another computer.)

You can check out a music file, check it back in, and then check it out again an infinite number of times. The SDMI rules provide that up to four copies of a music file can be checked out at one time. OpenMG employs a method whereby three copies of a song can be checked out simultaneously, while the fourth copy is maintained as a master on your PC.

Electronic Music Distribution (EMD) service

EMD is a website that distributes music files which are available for purchase.

MP3

MP3, which stands for MPEG-1 Audio Layer³, is a standard for audio file compression determined by the Motion Picture Experts Group, an ISO (International Organization for Standardization) working group. It enables compression of audio files to about 1/10 of the data size of a standard compact disc. Since the MP3 encoding algorithm is disclosed, there are various encoders/decoders that are compliant with this standard, including freeware that is available for no charge. The MP3 standard is therefore widely used in the computer field.

Music Drive

Music Drive is a music database for managing audio data on a computer. In Music Drive, audio files can be managed along with such information as artist names, track names, and CD jacket images, or can be combined and categorized in different playlists.

OpenMG

Copyright protection technology for the import and management of musical content from distribution services or CDs. By using software that are compliant with OpenMG, audio contents can be encrypted before storage on a hard disk drive to allow playback of those audio files on that computer. OpenMG also prevents the unauthorized distribution of the contents via the Internet or other networks.

Playlist

A playlist is like a container that can be used to hold and categorize files stored in Music Drive. For example, by making a “jazz” playlist and then putting your favorite jazz tracks into the playlist, you can play all of the tracks repeatedly or check them all out at the same time.

continued

Recording mode (Bit rate)

This is a measure of data volume per second. The rate is expressed in bps (bits per second). In SonicStage, the bit rate can be selected for recording an audio CD or converting MP3 and WAV format audio files into ATRAC3 format from among three rates: 132 kbps, 105 kbps or 66 kbps. In the case of 105 kbps, 105,000 bits of information is processed per second. If the bit rate is large, that means a large amount of information is used to play the music. Thus, 105 kbps data produces better sound quality than 66 kbps data, and 132 kbps data provides better sound quality than 105 kbps data. However, audio files in formats such as MP3 have different encoding methods, and so the sound quality is not determined by the bit rate alone.

SDMI

SDMI, which stands for Secure Digital Music Initiative, is a forum that consists of over 130 companies in the fields of recorded audio content, computers, and consumer electronics. It is dedicated to the development of integrated copyright protection technology that can be used worldwide.

SDMI is working to create a framework for preventing the improper usage of audio files and to promote legal music distribution services. The copyright protection technology OpenMG is based on the SDMI standard.

Windows Media Audio

This is an audio compression technology that includes the management system called "Windows Media Rights Manager".

Windows Media Technology

This is a technology that includes a contents management system called Windows Media Rights Manager which encrypts contents and distributes music contents along with their conditions for usage, distribution, etc. Audio files supporting Windows Media Technologies (WMT) downloaded via EMD* can be imported into and managed by OpenMG Jukebox.

* EMD may not be available in certain areas of the world.

Index

- A
- Accessories
 - optional 28
 - supplied 11
- ATRAC3 60, 63
- Audio CD 32, 41
- AVLS 25
- B
- back up 53
- Battery life 14
- C
- CD-ROM 35
- Check-in 60, 63
- Check-out 44, 60, 63
- Cleaning 27
- Connecting 39
- copyright protection 61
- D
- delete (software) 54
- Device/Media 44, 49
- Digital Sound Preset 19
- DSP TYPE-S 31
- E
- EMD services 63
- G
- G-PROTECTION 17
- Group
 - function 21
 - play 21
 - skip 21
- H
- hard disk
 - free space 35, 53
 - storing 41
- HOLD 15, 25
- I
- Index search 17
- Installing 37
- L
- labeling 43
- M
- MP3 63
- Music Drive 41, 63
- N
- Net MD 33, 60
- Net MD driver 58
- O
- Online help 48
- OpenMG 63
- OpenMG Jukebox software 36, 52
- P
- Play mode
 - group 22
 - tracks 18
- Playlist 44, 63
- Q
- Quick Mode 24
- R
- Recording mode (Bit rate) 42, 45, 64
- Recording navigation window 41
- S
- SDMI 64
- SonicStage Premium 36, 52
- SonicStage software (earlier version) 36, 52
- start (software) 40
- System environment 35
- System limitations 35
- T
- Time search 17
- Transferring
 - to the computer 40
 - to the Net MD 44
- U
- Uninstalling
 - Windows 2000 55
 - Windows 98 Second Edition 54
 - Windows Millennium Edition 54
 - Windows XP 54
- USB cable 11
- W
- Windows 2000 55
- Windows 98 Second Edition 54
- Windows Millennium Edition 54
- Windows XP 54
- WMA 64
- WMT 64

This warranty is valid only in Canada.

SONY[®]

Portable Memory Stick Audio Player
Portable IC Audio Player
Portable MiniDisc Recorder

LIMITED WARRANTY

Sony of Canada ("Sony") warrants this Product (including any accessories) against defects in material or workmanship as follows:

1. **LABOUR:** For a period of 90 days from the date of purchase, if this Product is determined to be defective, Sony will repair or replace the Product, at its option, at no charge, or pay the labour charges to any Sony authorized service facility. After the Warranty Period, you must pay for all labour charges.
2. **PARTS:** In addition, Sony will supply, at no charge, new or rebuilt replacements in exchange for defective parts for a period of one (1) year. After 90 days from the date of purchase, labour for removal and installation is available from Sony authorized service facilities or a Sony Service Centre at your expense.

You can extend the warranty period for an additional nine months by registering your product (www.sonystyle.ca). Once you register your product, the limited warranty period is twelve months from the original date of purchase from Sony or a Sony authorized dealer. The ninety (90) day warranty period is extendable only to the original purchaser, for an additional period of nine (9) months, for a total of twelve (12) months from the date of purchase when the Product is registered electronically. After the applicable period you must pay for all parts and labour charges.

To obtain warranty service, you must take the Product, or deliver the Product freight prepaid, in either its original packaging or packaging affording an equal degree of protection, to any authorized Sony service facility.

This warranty does not cover customer instruction, installation, set up adjustments or signal reception problems.

This warranty does not cover cosmetic damage or damage due to acts of God, accident, misuse, abuse, negligence, commercial use, or modification of, or to any part of the Product, including the antenna. This warranty does not cover damage due to improper operation or maintenance, connection to improper voltage supply, or attempted repair by anyone other than a facility authorized by Sony to service the Product. This warranty does not cover Products sold AS IS or WITH ALL FAULTS, or consumables (such as fuses or batteries). This warranty is valid only in Canada.

Proof of purchase in the form of a bill of sale or receipted invoice which is evidence that the unit is within the Warranty period must be presented to obtain warranty service.

This warranty is invalid if the factory-applied serial number has been altered or removed from the Product.

REPAIR OR REPLACEMENT AS PROVIDED UNDER THIS WARRANTY IS THE EXCLUSIVE REMEDY OF THE CONSUMER. SONY SHALL NOT BE LIABLE FOR ANY INCIDENTAL OR CONSEQUENTIAL DAMAGES FOR THE BREACH OF ANY EXPRESS OR IMPLIED WARRANTY ON THIS PRODUCT, EXCEPT TO THE EXTENT PROHIBITED BY APPLICABLE LAW. ANY IMPLIED WARRANTY OF MERCHANTABILITY OR FITNESS FOR A PARTICULAR PURPOSE ON THIS PRODUCT IS LIMITED IN DURATION TO THE DURATION OF THIS WARRANTY.

Some provinces do not allow the exclusion or limitation of incidental or consequential damages, or allow limitations on how long an implied warranty lasts, so the above limitations or exclusions may not apply to you. This warranty gives you specific legal rights, and you may have other rights which vary from province to province.

For your convenience, Sony of Canada Ltd. has established telephone numbers for frequently asked questions:

To locate the service or dealer nearest you, or for service assistance or resolution of a service problem, or for product information or operation, call:

Sony Customer Information Center

1 (877) 770-7669

or write to:

Sony of Canada Ltd.

115 Gordon Baker Road, Toronto, Ontario M2H 3R6 CANADA

or visit:

www.sonystyle.ca/productregistration

Portable Audio

This information is used to process your warranty registration and for after-sales support purposes. It may also be used by Sony of Canada Ltd. and affiliated Sony companies for customer relationship development and analysis, and to provide you with information and promotional offers on other products and services that may be of interest to you. For a copy of our Privacy Code, please visit our website at www.sonystyle.ca/privacy or call 1-877-899-7669.

This warranty is valid only in the United States.

SONY[®]

Portable Memory Stick Audio Player/
Portable MiniDisc Recorder/
Portable CD Player

LIMITED WARRANTY

Portable Audio

Sony Electronics Inc. ("Sony") warrants this Product (including any accessories) against defects in material or workmanship as follows:

1. **LABOR:** For a period of 90 days from the date of purchase, if this Product is determined to be defective, Sony will repair or replace the Product, at its option, at no charge, or pay the labor charges to any Sony authorized service facility. After the Warranty Period, you must pay for all labor charges.

2. **PARTS:** In addition, Sony will supply, at no charge, new or rebuilt replacements in exchange for defective parts for a period of one (1) year. After 90 days from the date of purchase, labor for removal and installation is available from Sony authorized service facilities or a Sony Service Center at your expense.

To obtain warranty service, you must take the Product, or deliver the Product freight prepaid, in either its original packaging or packaging affording an equal degree of protection, to any authorized Sony service facility.

This warranty does not cover customer instruction, installation, set up adjustments or signal reception problems.

This warranty does not cover cosmetic damage or damage due to acts of God, accident, misuse, abuse, negligence, commercial use, or modification of, or to any part of the Product, including the antenna. This warranty does not cover damage due to improper operation or maintenance, connection to improper voltage supply, or attempted repair by anyone other than a facility authorized by Sony to service the Product. This warranty does not cover Products sold AS IS or WITH ALL FAULTS, or consumables (such as fuses or batteries). This warranty is valid only in the United States.

Proof of purchase in the form of a bill of sale or receipted invoice which is evidence that the unit is within the Warranty period must be presented to obtain warranty service.

This warranty is invalid if the factory applied serial number has been altered or removed from the Product.

REPAIR OR REPLACEMENT AS PROVIDED UNDER THIS WARRANTY IS THE EXCLUSIVE REMEDY OF THE CONSUMER. SONY SHALL NOT BE LIABLE FOR ANY INCIDENTAL OR CONSEQUENTIAL DAMAGES FOR BREACH OF ANY EXPRESS OR IMPLIED WARRANTY ON THIS PRODUCT, EXCEPT TO THE EXTENT PROHIBITED BY APPLICABLE LAW. ANY IMPLIED WARRANTY OF MERCHANTABILITY OR FITNESS FOR A PARTICULAR PURPOSE ON THIS PRODUCT IS LIMITED IN DURATION TO THE DURATION OF THIS WARRANTY.

Some states do not allow the exclusion or limitation of incidental or consequential damages, or allow limitations on how long an implied warranty lasts, so the above limitations or exclusions may not apply to you. In addition, if you enter into a service contract with the Sony Partnership within 90 days of the date of sale, the limitation on how long an implied warranty lasts does not apply to you. This warranty gives you specific legal rights, and you may have other rights which vary from state to state.

For your convenience, Sony Electronics Inc. has established telephone numbers for frequently asked questions:

To locate the servicer or dealer nearest you, or for service assistance or resolution of a service problem, or for product information or operation, contact:

www.sony.com/walkmansupport

Sony Network Portable Audio Support Line
1-(866)-456-7669

Sony Customer Information Service Center
12451 Gateway Blvd.
Fort Myers, FL 33913

For an accessory or part not available from your authorized dealer, call:

1-(800)-488-SONY (7669)

D324343302



Printed using VOC (Volatile Organic Compound)-free vegetable oil ink.

<http://www.sony.net/>

Printed in Malaysia



* 3 2 5 3 6 0 0 1 2 *

(2)