

Instruction Manual

HI8417 - HI8519 HI8520 - HI8521

Microprocessor Bench-top pH Meters

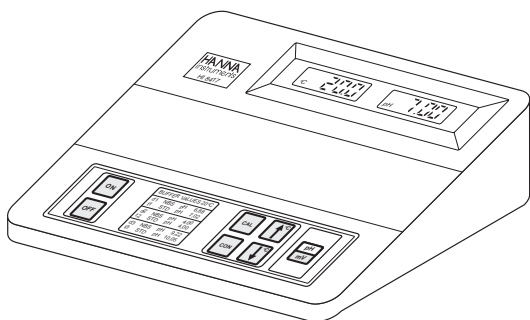

 **HANNA**
instruments

<http://www.hannainst.com>

CE

These Instruments are in
Compliance with the CE Directives

Dear Customer,

Thank you for choosing a Hanna Instruments Product.

Please read this instruction manual carefully before using the instrument.

This manual will provide you with all the necessary information for the correct use of the instrument, as well as a precise idea of its versatility in a wide range of applications.

These instruments are in compliance with CSA, UL and **CE** (EN 50081-1 and EN 50082-1) directives.

TABLE OF CONTENTS

PRELIMINARY EXAMINATION	3
GENERAL DESCRIPTION	3
FUNCTIONAL DESCRIPTION AND SPECIFICATIONS:	
HI8417	5
HI8519	8
HI8520	10
HI8521	12
OPERATIONAL GUIDE	14
PH CALIBRATION	18
PROCEDURE FOR HI8417	18
PROCEDURE FOR HI8519	20
PROCEDURE FOR HI8520/HI8521	21
CAL. W/ MANUAL TEMP. COMPENSATION	22
PH VALUES AT VARIOUS TEMPERATURE	23
TEMPERATURE CALIBRATION	23
TROUBLESHOOTING GUIDE	24
ELECTRODE CONDITIONING & MAINTENANCE	25
TEMPERATURE-RESISTANCE CORRELATION FOR HANNA PH SENSITIVE GLASS	28
ACCESSORIES	30
ELECTRODE APPLICATION REFERENCE GUIDE	37
WARRANTY	38
CE DECLARATION OF CONFORMITY	39



**ISO 9000 Certified
Company since 1992**

PRELIMINARY EXAMINATION

Remove the instrument from the packing material and examine it to make sure that no damage has occurred during shipping. If there is any damage, notify your dealer.

Note: Save all packing material until you are sure that the instrument functions correctly. All defective items must be returned in the original packing with the supplied accessories.

GENERAL DESCRIPTION

HI8417, HI8519, HI8520 and HI8521 Hanna Instruments bench-top pH meters are designed for simplicity of use.

They feature: large liquid crystal display (LCD), user friendly keyboard, error codes to guide the user in calibration and troubleshooting and storage of calibration data even after the unit is shut off.

HI8417, HI8519 and HI8521 can also measure ion concentration (ISE) and ORP in the mV range (with automatic range switching from ISE to ORP when reading exceeds $\pm 399.9\text{mV}$, HI8417 and HI8521 only).

All models, except for HI8519, are microprocessor-based and provide automatic or manual temperature compensation for both calibration and measurement.

These models meet the most stringent demands of the laboratory:

HI8417 pH/mV/°C meter automatically recognizes six standard calibration buffer values—three each for NBS (pH 4.01, 6.86, 9.18) technical standard calibration buffers (pH 4.01, 7.01, 10.01).

A recorder output of 0 to 2 Volts is available and the wide mV range and high resolution allow for ORP or ion-selective measurement.

HI8417 comes supplied with **HI1131B** glass-body combination pH electrode, **HI7669/2W** temperature probe (with 1 meter / 3.3' cable), 12VDC adapter (**HI710005** or **HI710006**) and a dust cover.

HI 8519 pH/mV meter includes: manual temperature compensation and front panel knobs for offset and slope calibration.

HI8519 comes supplied with **HI1332B** plastic-body combination pH electrode, 12VDC adapter (**HI710005** or **HI710006**) and a dust cover.

HI8520 pH/°C meter automatically recognizes 3 standard calibration buffer values (4.01, 7.01 and 10.01 pH).

HI8520 comes supplied with **HI1332B** plastic-body combination pH electrode, **HI7669/2W** temperature probe (with 1 meter/ 3.3' cable), 12VDC adapter (**HI710005** or **HI710006**) and a dust cover.

HI8521 pH/mV/°C meter automatically recognizes 3 standard calibration buffer values (4.01, 7.01 and 10.01 pH).

HI8521 comes supplied with **HI1332B** plastic-body combination pH electrode, **HI7669/2W** temperature probe (with 1 meter/ 3.3' cable), 12VDC adapter (**HI710005** or **HI710006**) and a dust cover.

FUNCTIONAL DESCRIPTION & SPECIFICATIONS OF HI8417

THE FRONT PANEL OF HI8417

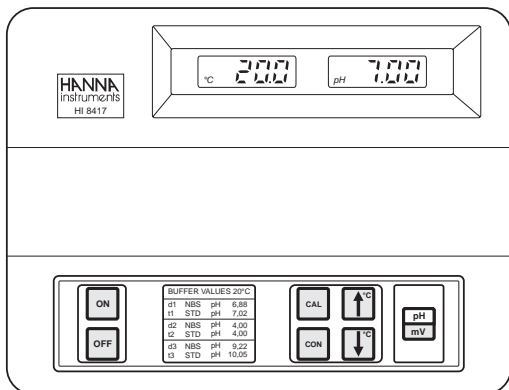

ON / OFF To turn the instrument ON and OFF. (Warning: Push the OFF key before unplugging instrument. If unplugged before turned off, the meter's memory will be erased).

CAL To enter the calibration mode.

CON To confirm the calibration data.

↑°C / ↓°C To set temperature for manual compensation.

pH/mV To select mV for mV, ORP or ISE measurements or pH for pH measurements.

Large LCD on the left

This LCD displays the temperature measured by the HI7669/2W probe or the value set manually with the keyboard. If the temperature has been set manually, the "°C" symbol will flash. When the temperature probe is connected the "°C" symbol stops flashing. When the temperature measured by the probe is out of range (-10 / +125°C), the "Err3" signal appears.

Large LCD on the right

This LCD displays the pH or mV reading. The corresponding pH or mV symbol will be displayed along with the measured value. An error signal ("Err1", "Err2", "Err4" or "Err5") will appear on this display to indicate when the range is exceeded or if the buffer during calibration is wrong.

THE REAR PANEL OF HI8417

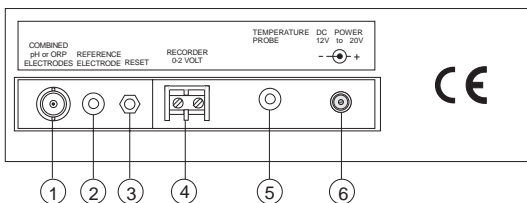

1. BNC socket for pH and ORP electrode.
2. Reference Jack socket for reference electrode.
3. RESET button.
4. Recorder output connections.
5. Temp. Probe socket (for HI7669/2W).
6. DC Power Socket (for HI710005 or HI710006).

Electrode and probe connections

For combination **pH or ORP** electrodes (with internal reference) plug the electrode's BNC to the socket provided (#1).

For an electrode with a separate reference, connect the measuring electrode's BNC to the BNC socket (#1) and the reference electrode's jack to the socket provided (#2).

For **temperature** measurements and automatic temperature compensation connect the temperature probe to the °C socket (#5).

Recorder Output

HI8417 is provided with a recorder output from 0 to 2 volts. Connect the recorder output (#4) and select the pH or mV range by pressing the pH/mV key. The output signal is related to the values as follows:

pH output:

e.g. $0.01 \text{ pH} = 1.42857 \text{ mV}$
 $0.00 \text{ pH} = 0 \text{ mV}$
 $7.00 \text{ pH} = 1000 \text{ mV}$
 $14.00 \text{ pH} = 2000 \text{ mV}$

mV output:

e.g. $0.1 \text{ mV} = 0.05 \text{ mV}$
 $-1999 \text{ mV} = 0 \text{ mV}$
 $0.0 \text{ mV} = 1000 \text{ mV}$
 $+1999 \text{ mV} = 2000 \text{ mV}$

The output impedance is 100 ohms. The maximum output short-circuit current is 20 mA.

RESET button

The RESET button (#3) is used when the instrument displays erroneous messages due to strong electrical interference or when the

instrument's power supply is disconnected before the meter is switched off. Press the RESET button and restart the entire operation.

Power connection

Plug the 12VDC adapter (**HI710005** or **HI710006**) into the DC socket (#6).

Note: Make sure the main line is protected by a fuse.

Note: **HI8417** uses a rechargeable battery to retain the pH calibration data. It lasts approximately one month when fully charged. The battery is automatically charged any time the meter is plugged-in (either turned on or off).

SPECIFICATIONS		HI8417
Range	pH	0.00 to 14.00
	ISE	0.0 to $\pm 399.9\text{mV}$
	ORP	$\pm 1999\text{mV}$
	$^{\circ}\text{C}$	-10.0 to 125.0
Resolution	pH	0.01
	ISE	0.1mV
	ORP	0.1/1mV
	$^{\circ}\text{C}$	0.1
Accuracy (@ 20 $^{\circ}\text{C}$ / 68 $^{\circ}\text{F}$)	pH	± 0.01
	ISE	$\pm 0.2\text{ mV}$
	ORP	$\pm 1\text{ mV}$
	$^{\circ}\text{C}$	± 0.5
Typical EMC Deviation	pH	± 0.01
	ISE/ORP	$\pm 0.2\text{mV}$
	$^{\circ}\text{C}$	± 0.7
Recorder Output	pH	0 to 2 V
	mV	0 to 2 V
	Max. Current	20mA
Offset		$\pm 1\text{ pH}$
Slope		from 85% to 105%
Calibration		Automatic 2 points with 5 memorized buffers (pH 4.01, 6.86, 7.01, 9.18, 10.01)
Temperature Compensation		Manual from 0 to 100 $^{\circ}\text{C}$ (32 to 212 $^{\circ}\text{F}$)
		Automatic from -10 to 125 $^{\circ}\text{C}$ (14 to 257 $^{\circ}\text{F}$)
Electrode		HI1131B glass body combination refillable pH electrode (included)
Temp. Probe		HI7669/2W Temperature Probe (included)
Input Impedance		10^{12} ohm
Power		Power socket for 12VDC
Environment		0 to 50 $^{\circ}\text{C}$ (32 to 122 $^{\circ}\text{F}$); 95% RH (not condensing)
Dimensions		230Lx170Wx70H mm (9.1x6.7x2.7")
Shipping Weight		1.5 Kg (3.3 lb.)

FUNCTIONAL DESCRIPTION & SPECIFICATIONS OF HI8519

THE FRONT PANEL OF HI8519

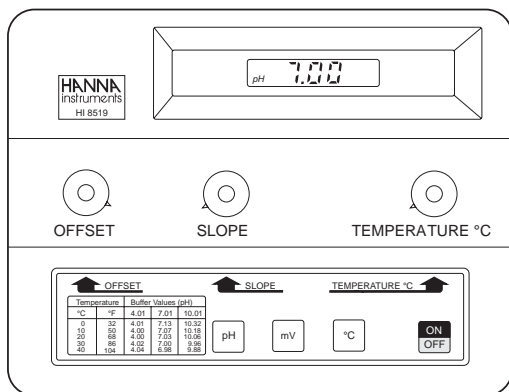

ON/OFF To switch the meter ON and OFF.

pH To display pH values.

mV To display mV values.

°C To display temperature values set by the temperature knob (for pH compensation).

Knobs

OFFSET For adjustment of offset during pH calibration.

SLOPE For adjustment of slope during pH calibration.

TEMP °C For setting temperature in °C.

THE REAR PANEL OF HI8519

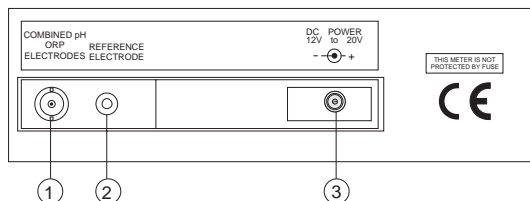

1. BNC socket for pH or ORP electrode.
2. Reference Jack socket for reference electrode.
3. DC Power Socket (for HI710005 or HI710006).

Electrode and probe connections

For combination **pH or ORP** electrodes (with internal reference) plug the electrode's BNC to the socket provided (#1).

For an electrode with a separate reference, connect the measuring electrode's BNC to the BNC socket (#1) and the reference electrode's jack to the socket provided (#2).

Power connection

Plug the 12VDC adapter (**HI710005** or **HI710006**) into the DC socket (#3).

Note: Make sure the main line is protected by a fuse.

SPECIFICATIONS		HI 8519
Range	pH	0.00 to 14.00
	mV	±1999
Resolution	pH	0.01
	mV	1
Accuracy (@20°C / 68°F)	pH	±0.01
	mV	±1
Typical EMC Deviation	pH	±0.06
	mV	±4
Calibration		Manual 2 points through offset and slope knobs
Temperature Compensation		Manual from 0 to 100°C (32 to 212°F)
Electrode		HI 1332B plastic body, combination, double junction refillable pH electrode (included)
Input Impedance		10 ¹² ohm
Power		12VDC power
Environment		0 to 50°C (32 to 122°F); 95% RH
Dimensions		230x170x70 mm (9.1x6.7x2.7")
Shipping Weight		1.35 Kg (3 lb.)

FUNCTIONAL DESCRIPTION & SPECIFICATIONS OF HI8520

THE FRONT PANEL OF HI8520

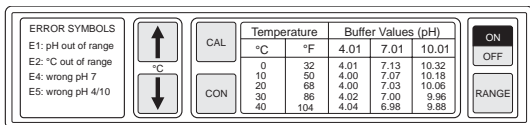

- ON / OFF To switch instrument ON and OFF.
- RANGE To display pH or temperature measurements.
- CAL/CON CAL to enter the calibration procedure and CON to confirm calibration data.

↑ / ↓ For setting temperature for manual compensation.

THE REAR PANEL OF HI8520

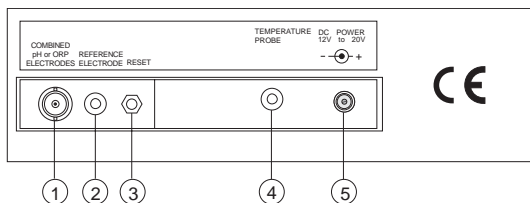

1. BNC socket for pH electrode.
2. Reference Jack socket for reference electrode.
3. RESET button.
4. Temperature Probe socket (for HI7669/2W).
5. DC Power Socket (for HI710005 or HI710006).

Electrode and probes connections

For combination **pH** electrodes (with internal reference) plug the electrode's BNC to the socket provided (#1).

For an electrode with a separate reference, connect the measuring electrode's BNC to the BNC socket and the reference electrode's jack to the socket provided (#2).

For **temperature** measurements and automatic temperature compensation connect the temperature probe to the °C socket (#4).

RESET button

The RESET button (#3) is used when the instrument displays erroneous messages due to strong electrical interference or when the instrument's power supply is disconnected before the meter is switched

off. Press the RESET button and restart the entire operation.

Power connection

Plug the 12VDC adapter (**HI710005** or **HI710006**) into the socket on the back of the meter (#5).

Note: Make sure the main line is protected by a fuse.

Note: **HI8520** uses a rechargeable battery to retain the pH calibration data. It lasts approximately one month when fully charged. The battery is automatically charged any time the meter is plugged-in (either turned on or off).

SPECIFICATIONS		HI 8520
Range	pH	0.00 to 14.00
	°C	0.0 to 100.0
Resolution	pH	0.01
	°C	0.1
Accuracy (@20°C / 68°F)	pH	±0.01
	°C	±0.4
Typical EMC Deviation	pH	±0.02
	°C	±0.4
Calibration		Automatic 2 points with auto-buffer recognition
Temperature Compensation		Automatic or Manual From 0 to 100°C (32 to 212°F)
Electrode		HI 1332B plastic body, combination, double junction refillable pH electrode (included)
Temperature Probe		HI 7669/2W temp. probe (included)
Input Impedance		10 ¹² ohm
Power		12VDC power
Environment		0 to 50°C (32 to 122°F); 95% RH
Dimensions		230x170x70 mm (9.1x6.7x2.7")
Shipping Weight		1.35 Kg (3 lb.)

FUNCTIONAL DESCRIPTION & SPECIFICATIONS OF HI8521

THE FRONT PANEL OF HI8521

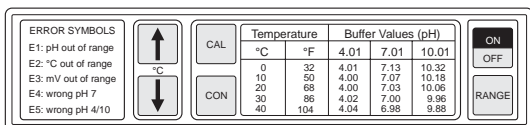

- ON / OFF** To switch instrument ON and OFF.
- RANGE** To display pH / ORP / Temperature measurements.
- CAL/CON** CAL to enter the calibration procedure and CON to confirm calibration data.

↑ / ↓ For setting temperature for manual compensation.

THE REAR PANEL OF HI8521

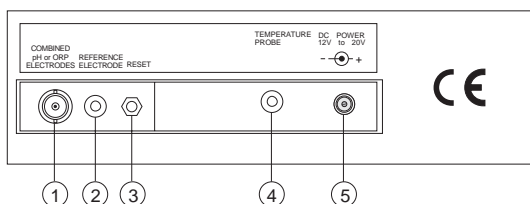

1. BNC socket for pH or ORP electrode.
2. Reference Jack socket for reference electrode.
3. RESET button.
4. Temperature Probe socket (for HI7669/2W).
5. DC Power Socket (for HI710005 or HI710006).

Electrode and probes connections

For combination **pH** or **ORP** electrodes (with internal reference) plug the electrode's BNC to the socket provided (#1).

For an electrode with a separate reference, connect the measuring electrode's BNC to the BNC socket and the reference electrode's jack to the socket provided (#2).

For **temperature** measurements and automatic temperature compensation connect the temperature probe to the °C socket (#4).

RESET button

The RESET button (#3) is used when the instrument displays erroneous messages due to strong electrical interference or when the

instrument's power supply is disconnected before the meter is switched off. Press the RESET button and restart the entire operation.

Power connection

Plug the 12VDC adapter (**HI710005** or **HI710006**) into the socket on the back of the meter (#5).

Note: Make sure your main line is protected by a fuse.

Note: **HI8521** uses a rechargeable battery to retain the pH calibration data. It lasts approximately one month when fully charged. The battery is automatically charged any time the meter is plugged-in (either turned on or off).

SPECIFICATIONS		HI 8521
Range	pH	0.00 to 14.00
	ISE	0.0 to $\pm 399.9\text{mV}$
	ORP	0 to $\pm 1999\text{mV}$
	$^{\circ}\text{C}$	0.0 to 100.0
Resolution	pH	0.01
	ISE	0.1mV
	ORP	1mV
	$^{\circ}\text{C}$	0.1
Accuracy (@20 $^{\circ}\text{C}$ / 68 $^{\circ}\text{F}$)	pH	± 0.01
	ISE	$\pm 0.2\text{mV}$
	ORP	$\pm 0.1\text{mV}$
	$^{\circ}\text{C}$	± 0.4
Typical EMC Deviation	pH	± 0.05
	ISE/ORP	$\pm 4\text{mV}$
	$^{\circ}\text{C}$	± 0.1
Calibration	Automatic 2 points with auto-buffer recognition	
Temperature Compensation	Automatic or Manual From 0 to 100 $^{\circ}\text{C}$ (32 to 212 $^{\circ}\text{F}$)	
Electrode	HI 1332B plastic body, combination, double junction refillable pH electrode (included)	
Temperature Probe	HI 7669/2W temp. probe (included)	
Input Impedance	10^{12} ohm	
Power	12VDC power	
Environment	0 to 50 $^{\circ}\text{C}$ (32 to 122 $^{\circ}\text{F}$); 95% RH	
Dimensions	230x170x70 mm (9.1x6.7x2.7")	
Shipping Weight	1.4 Kg (3.1 lb.)	

OPERATIONAL GUIDE

TAKING PH MEASUREMENTS

Connect the instrument to the 12VDC adapter (HI710005 or HI710006). Plug the adapter into the mains.

Make sure that the instrument has been calibrated for pH before taking pH measurements (see page 18).

For HI8519 only:

- Connect the pH electrode to the meter and switch the instrument on by pressing the ON/OFF key.



- Immerse the electrode tip (4 cm/1½") into the sample and shake briefly.

- Take the temperature of the solution with a ChecktempC or a glass thermometer (e.g. 25°C).



- Press the °C key to display temperature settings on the LCD.

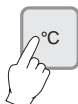

- Adjust the Temperature °C knob to display the temperature of the sample.



- Press the pH key to display the pH measurement.
- The display shows the pH value of the test solution compensated for temperature.



For HI8417, HI8520, HI8521 only:

- Connect the electrode and the temperature probe (if automatic temperature compensation is desired).

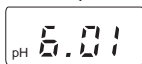

- Press the ON/OFF key to turn the meter on. The meter will automatically default to the pH measurement mode.



- Immerse the electrode and the temperature probe in the sample and shake briefly. Wait for 30 seconds before taking readings.



- The display shows the pH reading compensated for temperature.

- In HI8417 the temperature reading is also displayed on the left LCD.

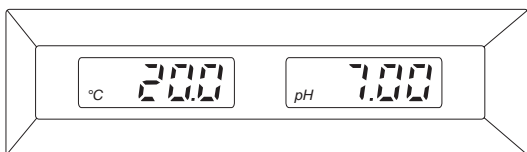

Note: the electrode should be submerged approximately 4 cm (1½") into the solution. If the temperature probe is used, it should be located as close to the pH electrode as possible.

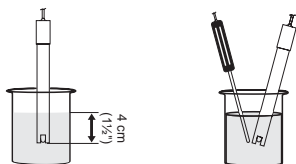

If measurements are taken in different samples successively, it is recommended that the electrode is rinsed thoroughly for better conditioning and to eliminate cross-contamination of the sample.

For the rinsing process, it is recommended to use a liberal amount of the next solution to be measured.

Using refillable electrodes

Unscrew the small refill cap to open the refill hole during measurements. After measurement replace the refill hole cap.



MANUAL TEMPERATURE COMPENSATION FOR HI8417, HI8520 AND HI8521

- When the temperature probe is not connected, take the temperature of the solution with a ChecktempC or a glass thermometer.



- Press the RANGE key to enter the temperature mode (not necessary for HI8417).



- When the temperature is set manually, "°C" symbol blinks. With the temperature probe connected, the "°C" symbol is displayed continuously.
- Use the UP or DOWN arrow keys to manually adjust the display reading to the value of the reference thermometer.

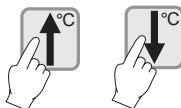
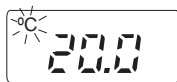

TAKING TEMPERATURE MEASUREMENTS (NOT FOR HI 8519)

- Taking a temperature measurement is very easy.
- Turn the instrument ON and press the RANGE key (for **HI8520** and **HI8521** only) to get into temperature mode.
- Make sure the temperature probe is connected and allow the reading to stabilize (1 or 2 minutes).
- The temperature value will be displayed on the left LCD for **HI8417**.



TAKING ORP MEASUREMENTS

HI8417, **HI8519** and **HI8521** have the capability to take ORP measurements, using an ORP electrode. Hanna Instruments offers a variety of ORP electrodes for this purpose (see page 35). Contact your Dealer for more information.

Just as pH measurements allow the acidity or the alkalinity of a substance to be expressed in numbers, oxidation-reduction potential (redox) measurements provide the quantification of the oxidizing or reducing power of any liquid.

For HI8519 only:

- Connect the ORP electrode to the meter and submerge the tip (4 cm / 1½") into the sample to be tested.

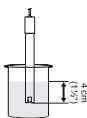

Note: ORP measurements are taken without temperature compensation.

- Press the mV key to enter the mV mode. Allow a few minutes for the reading to stabilize.
- The display will indicate the absolute mV value (positive or negative).



For HI8417 and HI8521

- Connect the ORP electrode to the meter and submerge the tip (4 cm / 1½") into the sample to be tested.

Note: ORP measurements are taken without temperature compensation.

- Press the pH/mV key (HI8417) or RANGE key (HI8521) once to enter the mV mode.



- Allow a few minutes for the reading to stabilize.

- The display will indicate the absolute mV value (positive or negative).

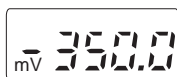

- When values are less than ± 400 mV, tenths of mV are displayed; for values greater than ± 400 mV, the decimal digit disappears. Note that the change in scale (from 0.1mV to 1mV resolution) is automatic. "Err2" for HI8417 or "E3" for HI8521 appears if the value exceeds ± 1999 mV (out of range).

AFTER MEASUREMENTS

- Press the ON/OFF key again to switch the instrument OFF.



PH CALIBRATION

IMPORTANT

The instrument's pH range should be re-calibrated:

- When the meter is new.
- Whenever the pH electrode is replaced.
- At least once a month.
- After use in aggressive chemicals.
- After cleaning procedure and changing the reference electrolyte.
- For greatest accuracy.

INITIAL PREPARATION

Pour small quantities (up to 4cm / 1½" level) of pH 7.01 (HI7007 or HI8007) and pH4.01 (HI7004 or HI8004) or pH 10.01 (HI7010 or HI8010) solution into clean beakers. If possible use plastic beakers to minimize any EMC interferences.

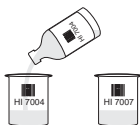

If you are measuring in the acid range use pH4.01 as second buffer or pH 10.01 if you are measuring in the alkaline range.

Note: with HI8417 HI7006/HI8006 (pH 6.86) and HI7009/HI8009 (pH 9.18) can be used in place of HI7007/HI8007 (pH 7.01) and HI7010/HI8010 (pH 10.01) respectively.

For accurate calibration, use two beakers for each buffer solution; the first for rinsing the electrode, the second for calibration. In this way, contamination of the buffer is minimized.

RINSE



CALIBRATION

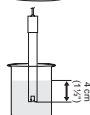

Note: the electrode should be submerged approximately 4 cm (1½") into the solution. If the temperature probe is used, it should be positioned as close to the pH electrode as possible.



PH CALIBRATION FOR HI8417

HI8417 provides 6 pre-programmed calibration buffers: three NBS buffers (d1, d2, d3 i.e. pH 6.86, 4.01, 9.18 respectively) and three technical buffers (t1, t2, t3 i.e. pH 7.01, 4.01, 10.01 respectively).

When the ATC probe is not used, make sure the temperature is set manually to reflect the temperature of the solution (see page 23).

Procedure:

- Switch the instrument on after connecting the pH electrode and the temperature probe.
- Immerse the pH electrode and the ATC probe into a neutral pH buffer solution (pH 7.01 for technical buffers, or pH 6.86 for NBS buffers).

Shake briefly and wait 1-2 minutes for thermal equilibrium.

- Press the CAL key. The symbol "d1" will appear on the display. For calibration with technical buffers (pH 7.01), press CAL key again and "t1" will appear on the display.

(Note: the "pH" symbol will be flashing throughout the calibration procedure).

- Press the CON key. The buffer value will be displayed on the right LCD.
- Allow 1-2 minutes for the pH reading to stabilize.

The pH reading will be temperature compensated.

E.g. if the buffer temperature is at 25°C, the right display will show "pH 7.01". If the buffer temperature is at 20°C, the display will show "pH 7.03" (see page 23).

°C 20.0

pH 7.03

If "Err4" appears the calibration solution is wrong. Repeat the process using fresh buffers.

Err4

Note: If you are not using the ATC probe, refer to page 22 to manually correct for temperature.

- Press the CON key again to accept the buffer value. The first point calibration is now complete.
- If the pH/mV key is pressed at this point, the calibration process is ended and only the offset of the meter is calibrated. This is known as one point calibration. For greatest accuracy, however, it is recommended that a two-point calibration is performed.
- Rinse the electrode and the temperature probe before immersing them into pH 4.01/ pH10.01 (or 9.18) calibration buffer, shake briefly and wait for thermal equilibrium.



d 1

t 1



- The meter automatically recognizes the buffer value and prompts for the second at "d2" or "t2" (= pH 4.01, acid) or "d3" or "t3" (pH 9.18 and pH10.01 respectively, alkaline).

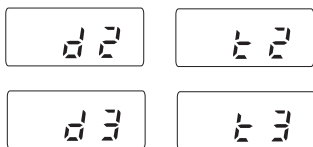

- Press the CON key to confirm the pH value.
- The display will indicate the temperature compensated buffer value e.g. if the temperature is at 25°C, the display will show "pH 4.01" or "10.01" or "pH 9.18", depending on the solution being used. If the temperature is at 20°C, the display will show respectively "pH 4.00" or "pH 10.06" or "pH 9.22" (see page 23).



- Press CON key again to confirm calibration. The meter is now calibrated.
- The pH symbol will stop flashing and the unit is ready for measurements.
- If the reading is drifting, turn the meter off and repeat the calibration procedure waiting longer for the reading to stabilize. However, usually 1 or 2 minutes is enough time to prevent a drifting reading.



Note: If you need to unplug the instrument, press the OFF key thus switching the instrument off before disconnecting the power cord. In this way the instrument will retain the calibration data. Otherwise, re-calibration might be necessary. In the case of a power failure while the instrument is operational, re-calibration might be required.

PH CALIBRATION FOR HI8519

Note: If you need to calibrate to NBS standards, use pH 6.86 (HI7006 or HI8006) and pH 9.18 (HI7009 or HI8009) instead of pH7.01 and 10.01 respectively.

Use a ChecktempC or a glass thermometer with an resolution of 0.1° as reference thermometer.

Procedure:

- Switch the instrument on after connecting the pH electrode.
- Rinse and immerse the pH electrode in pH 7.01 buffer and shake briefly. Wait 1 or 2 minutes for the reading to stabilize.
- Note the temperature of the buffer solution using a ChecktempC or a glass thermometer (e.g. 20°C).
- Press the °C key to select temperature setting. Adjust the Temperature °C knob until display shows the noted temperature.

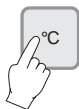

TEMPERATURE °C →



- Press the pH key to select pH measurement.
- Wait 1-2 minutes and adjust the OFFSET knob until display shows the pH value at the noted temperature (see the pH versus temperature chart at page 23).
- Rinse and immerse the pH electrode in pH 4.01/pH 10.01 buffer and shake briefly.



OFFSET →



- Wait 1-2 minutes and adjust the SLOPE knob until display shows the pH value at the noted temperature (see the pH versus temperature chart at page 23).
- The pH calibration is now complete.



SLOPE →



PH CALIBRATION FOR HI8520 AND HI8521

Procedure:

- Switch instrument on after connecting the pH electrode and the temperature probe.
- Immerse the pH electrode and the temperature probe in pH 7.01 buffer solution, shake briefly and wait 1 or 2 minutes for thermal equilibrium.
- Press the RANGE key to display pH measurement.

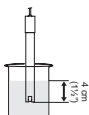

- Press the CAL key. The temperature compensated buffer value will be displayed e.g. if the buffer temperature is at 25°C, the display will show pH7.01. If the buffer temperature is at 20°C, display will show pH 7.03 (see page 23). If "E4" appears the calibration solution is wrong.

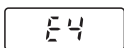
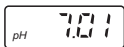

- Wait until the pH symbol stops flashing: that means the reading is stable.
- Press the CON key. The symbol "E5" will appear to indicate that the electrode is still in pH 7.01 buffer, but expecting a pH 4.01 or 10.01 buffer.

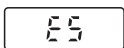

- Rinse the electrode and temperature probe before immersing them into pH 4.01 / pH 10.01 calibration buffer, shake briefly and wait for thermal equilibrium.
- The symbol "E5" should disappear and the temperature compensated buffer value is flashing.
- Wait until the pH symbol stops flashing, press the CON key to confirm the calibration.
- The pH calibration is now complete.

CALIBRATION WITH MANUAL TEMPERATURE COMPENSATION FOR HI8417, HI8520 AND HI8521 ONLY)

If for some reason the temperature probe is defective, or it is required to calibrate with manual temperature compensation, follow the procedure below:

- Unplug the temperature probe from the meter.
- Note the temperature of the buffer with a ChecktempC or a glass thermometer.
- Use the UP and DOWN arrow keys to set the temperature to the noted temperature.

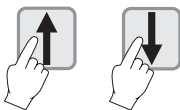

- Follow the calibration procedure as for pH calibration with temperature probe connected (see page 18 for HI8417 or page 21 for HI8520/HI8521).

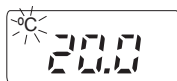

PH VALUES AT VARIOUS TEMPERATURE

Temperature has an effect on pH. The calibration buffer solutions are effected by temperature changes to a lesser degree than normal solutions.

For manual temperature calibration (standard with **HI 8519** or optional with **HI 8417**, **HI 8520** and **HI 8521**) please refer to the following chart.

TEMP		pH VALUES				
°C	°F	4.01	6.86	7.01	9.18	10.01
0	32	4.01	6.98	7.13	9.46	10.32
5	41	4.00	6.95	7.10	9.39	10.24
10	50	4.00	6.92	7.07	9.33	10.18
15	59	4.00	6.90	7.04	9.27	10.12
20	68	4.00	6.88	7.03	9.22	10.06
25	77	4.01	6.86	7.01	9.18	10.01
30	86	4.02	6.85	7.00	9.14	9.96
35	95	4.03	6.84	6.99	9.10	9.92
40	104	4.04	6.84	6.98	9.07	9.88
45	113	4.05	6.83	6.98	9.04	9.85
50	122	4.06	6.83	6.98	9.01	9.82
55	131	4.07	6.84	6.98	8.99	9.79
60	140	4.09	6.84	6.98	8.97	9.77
65	149	4.11	6.85	6.99	8.95	9.76
70	158	4.12	6.85	6.99	8.93	9.75

For instance, if the buffer temperature is 25°C, the display should show pH 4.01, 7.01 or 10.01 at pH 4, 7 or 10 buffers, respectively. At 20°C, the display should show pH 4.00, 7.03 or 10.06. The meter reading at 50°C will then be 4.06, 6.98 or 9.82.

TEMPERATURE CALIBRATION (HI8417, HI8520, HI8521 ONLY)

All Hanna bench-top meters have been accurately temperature calibrated at the factory. We recommend that you have your bench-top meters temperature calibrated once a year.

Your nearest Hanna Service Center is available to quickly service your meter. Contact your Dealer or the nearest Hanna Service Center for more information.

TROUBLESHOOTING

Symptoms are:	The Problem is:	Possible Solutions:
The instrument does not work with the HI7669/2W probe (not HI8519)	A defective ATC Probe	Replace the probe.
The meter fails to calibrate or gives erroneous results	A defective pH electrode	Replace the electrode and repeat the pH calibration.
The meter is slow in responding or gives erroneous readouts	The electrode is not working or the diaphragm is clogged	Leave the electrode in a storage solution after cleaning the diaphragm. If the problem is not solved, replace the electrode and re-calibrate the pH scale.
The meter does not accept the 2nd buffer solution	A defective pH electrode or bad buffer solution	Try the cleaning procedure. If this does not work, replace the electrode and re-calibrate the pH. Use fresh buffer solution.
The reading drifts	Temperature not stable	Thermal equilibrium not reached. Wait longer.
"Err1" (for HI8417) "E 1" (for HI8520/ HI8521) on the display	Out of range on the pH scale	a) Verify the pH electrode is connected. b) Make sure the pH sample is included between 0 and 14 pH. c) Check the level of the electrode's filling electrolyte and the state of the electrode itself.
"Err3" (for HI8417) "E 2" (for HI8520/ HI8521) on the display	Out of range in °C	Verify the temperature probe is connected and make sure the °C is within -10/125°C for HI8417 or -10/100°C for HI8520/HI8521.
"Err2" (for HI8417) "E 3" (for HI8521) on the display	Out of range in mV	Verify the temperature probe is connected and make sure the mV is within ±1999 range.
"Err4" (for HI8417) "E 4" (for HI8520/ HI8521) on the display	Erroneous buffer solution used for offset calibration	Make sure that the buffer solution used is of pH 7 and replace if necessary.
	Defective electrode	Replace the electrode and re-calibrate the pH scale.
"Err5" (for HI8417) "E 5" (for HI8520/ HI8521) on the display	Erroneous buffer solution used for slope calibration	Be sure the correct pH buffer solution is being used for slope calibration (4.01, 9.18 or 10.01 pH).
	Defective electrode	Check the electrode and replace if necessary.

ELECTRODE CONDITIONING AND MAINTENANCE

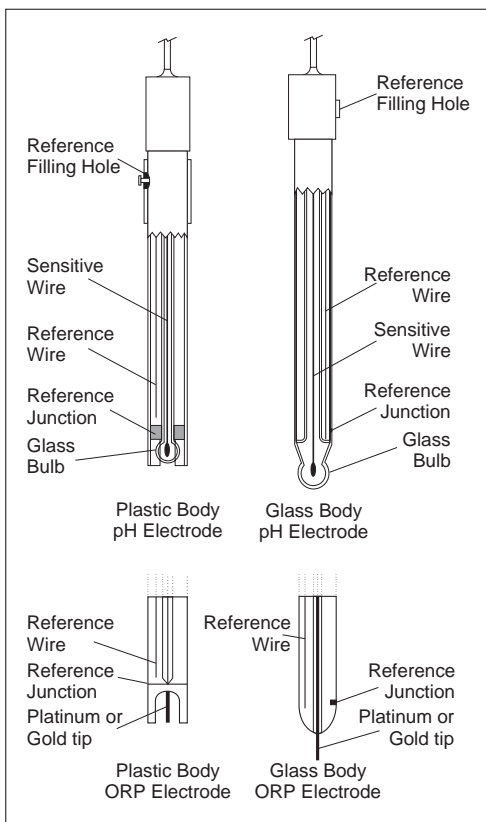

PREPARATION

Remove the protective cap.

DO NOT BE ALARMED IF ANY SALT DEPOSITS ARE PRESENT. This is normal with electrodes and they will disappear when rinsed with water. During transport tiny bubbles of air may form inside the glass bulb affecting proper functioning of the electrode. These bubbles can be removed by "shaking down" the electrode as you would do with a glass thermometer.

If the bulb and/or junction is dry, soak the electrode in **HI 70300** or **HI 80300** Storage Solution for at least one hour.

For refillable electrodes:

If the filling solution (electrolyte) is more than 2½ cm (1") below the fill hole, add **HI 7082** or **HI 8082** 3.5M KCl Electrolyte Solution for double junction or **HI 7071** or **HI 8071** 3.5M KCl + AgCl Electrolyte Solution for single junction electrodes.

For a faster response, unscrew the fill hole screw during measurements.

For AmpHel® electrodes:

If the electrode does not respond to pH changes, the battery is run down and the electrode should be replaced.

MEASUREMENT

Rinse the electrode tip with distilled water. Immerse the tip (bottom 4 cm /1½") in the sample and stir gently for a few seconds.

For a faster response and to avoid cross contamination of the samples, rinse the electrode tip with a few drops of the solution to be tested, before taking measurements.

STORAGE

To minimize clogging and assure a quick response time, the glass bulb and the junction should be kept moist and not allowed to dry out.

Replace the solution in the protective cap with a few drops of **HI 70300** or **HI 80300** Storage Solution or, in its absence, Filling Solution (**HI 7071** or **HI 8071** for single junction or **HI 7082** or **HI 8082** for double junction electrodes). Follow the Preparation Procedure above before taking measurements.

Note: NEVER STORE THE ELECTRODE IN DISTILLED OR DEIONIZED WATER.

PERIODIC MAINTENANCE

Inspect the electrode and the cable. The cable used for connection to the meter must be intact and there must be no points of broken insulation on the cable or cracks on the electrode stem or bulb. Connectors must be perfectly clean and dry. If any scratches or cracks are present, replace the electrode. Rinse off any salt deposits with water.

For refillable electrodes:

Refill the reference chamber with fresh electrolyte (**HI 7071** or **HI 8071** for single junction or **HI 7082** or **HI 8082** for double junction electrodes). Allow the electrode to stand upright for 1 hour.

Follow the Storage Procedure above.

CLEANING PROCEDURE

General Soak in Hanna **HI 7061** or **HI 8061** General Cleaning Solution for approximately ½ hour.

Removal of films, dirt or deposits on the membrane/junction:

- *Protein* Soak in Hanna **HI 7073** or **HI 8073** Protein Cleaning Solution for 15 minutes.
- *Inorganic* Soak in Hanna **HI 7074** or **HI 8074** Inorganic Cleaning Solution for 15 minutes.
- *Oil/grease* Rinse with Hanna **HI 7077** or **HI 8077** Oil and Fat Cleaning Solution.

IMPORTANT: After performing any of the cleaning procedures rinse the electrode thoroughly with distilled water, refill the reference chamber with fresh electrolyte (not necessary for gel-filled electrodes) and soak the electrode in **HI 70300** or **HI 80300** Storage Solution for at least 1 hour before taking measurements.

TROUBLESHOOTING

Evaluate your electrode performance based on the following.

- **Noise** (Readings fluctuate up and down) could be due to:
 - **Clogged/Dirty Junction:** Refer to the Cleaning Procedure above.
 - **Loss of shielding** due to low electrolyte level (in refillable electrodes only): refill with fresh **HI 7071** or **HI 8071** for single junction or **HI 7082** or **HI 8082** for double junction electrodes.
- **Dry Membrane/Junction:** Soak in **HI 70300** or **HI 80300** Storage Solution for at least 1 hour.
- **Drifting:** Soak the electrode tip in warm (approx. 50-60°C) Hanna **HI 7082** or **HI 8082** Solutions for one hour and rinse the tip with distilled water. Refill with fresh **HI 7071** or **HI 8071** for single junction electrodes and **HI 7082** or **HI 8082** for double junction electrodes (refillable electrodes only).
- **Low Slope:** Refer to the cleaning procedure above.
- **No Slope:** Check the electrode for cracks in glass stem or bulb and replace the electrode.
- **Slow Response/Excessive Drift:** Soak the tip in **HI 7061** or **HI 8061** Solutions for 30 minutes, rinse thoroughly in distilled water and then follow the Cleaning Procedure above.

TEMPERATURE-RESISTANCE CORRELATION

The resistance of glass electrodes partially depends on the temperature. The lower the temperature, the higher the resistance. It takes longer time for the reading to stabilize if the resistance is higher. In addition, the response time will suffer to a greater degree at temperatures below 10°C.

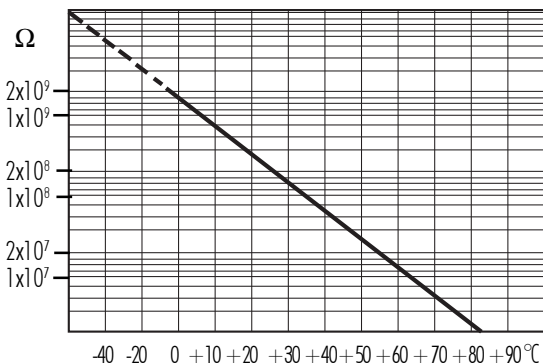

Since the resistance of the pH electrode is in the range of 200 Mohm, the current across the membrane is in the pico Ampere range. Large currents can disturb the calibration of the electrode for many hours.

For these reasons **high humidity environments, short circuits and static discharges** are detrimental for a stable pH reading.

The pH electrode's life also depends on the temperature. If constantly used at high temperatures, the electrode life is drastically reduced.

Typical Electrode Life

Ambient Temperature

90 °C

120°C

1- 3 years

Less than 4 months

Less than 1 month

High concentrations of sodium ions interfere with readings in alkaline solutions; the pH at which the interference starts to be significant depends upon the composition of the glass. This interference is the alkaline error and causes the pH to be underestimated. Hanna's glass formulations have the indicated characteristics.

Alkaline Error

Sodium Ion Correction for the Glass at 20-25°C		
Concentration	pH	Error
0.1 Mol L ⁻¹ Na ⁺	13.00	0.10
	13.50	0.14
	14.00	0.20
1.0 Mol L ⁻¹ Na ⁺	12.50	0.10
	13.00	0.18
	13.50	0.29
	14.00	0.40

ACCESSORIES

pH CALIBRATION SOLUTIONS

HI 70004P	pH 4.01 Buffer Sachets, 20mL, 25 pcs
HI 70007P	pH 7.01 Buffer Sachets, 20mL, 25 pcs
HI 70010P	pH 10.01 Buffer Sachets, 20mL, 25 pcs
HI 7004L	pH 4.01 Buffer Solution, 460 mL
HI 7006L	pH 6.86 Buffer Solution, 460 mL
HI 7007L	pH 7.01 Buffer Solution, 460 mL
HI 7009L	pH 9.18 Buffer Solution, 460 mL
HI 7010L	pH 10.01 Buffer Sol., 460 mL

pH CALIBRATION SOLUTIONS IN FDA APPROVED BOTTLES

HI 8004L	pH 4.01 Buffer Solution, 460 mL
HI 8006L	pH 6.86 Buffer Solution, 460 mL
HI 8007L	pH 7.01 Buffer Solution, 460 mL
HI 8009L	pH 9.18 Buffer Solution, 460 mL
HI 8010L	pH 10.01 Buffer Solution, 460 mL

ELECTRODE STORAGE SOLUTION

HI 70300L	Storage Solution, 460 mL
-----------	--------------------------

ELECTRODE STORAGE SOLUTION IN FDA APPROVED BOTTLES

HI 80300L	Storage Solution, 460 mL
-----------	--------------------------

ELECTRODE CLEANING SOLUTIONS

HI 70000P	Electrode Cleaning Sachets, 20 mL, 25 pcs
HI 7061L	General Cleaning Sol., 460 mL
HI 7073L	Protein Cleaning Sol., 460mL
HI 7074L	Inorganic Cleaning Sol., 460mL
HI 7077L	Oil & Fat Cleaning Sol., 460 mL

ELECTRODE CLEANING SOLUTIONS IN FDA APPROVED BOTTLES

HI 8061L	General Cleaning Solution, 460 mL
HI 8073L	Protein Cleaning Solution, 230 mL
HI 8077L	Oil & Fat Cleaning Solution, 460mL

REFILL ELECTROLYTE SOLUTIONS

HI 7071	3.5M KCl + AgCl Electrolyte, 4x50mL, for single junction electrodes
HI 7072	1M KNO ₃ Electrolyte, 4x50 mL

HI 7082 3.5M KCl Electrolyte, 4x50 mL, for double junction electrodes

REFILL ELECTROLYTE SOLUTIONS IN FDA APPROVED BOTTLES

HI 8071 3.5M KCl + AgCl Electrolyte, 4x50mL, for single junction electrodes

HI 8072 1M KNO₃ Electrolyte, 4x50 mL

HI 8082 3.5M KCl Electrolyte, 4x50 mL, for double junction electrodes

ORP PRETREATMENT SOLUTIONS

HI 7091L Reducing Pretreatment Solution, 460 mL

HI 7092L Oxidizing Pretreatment Solution, 460 mL

pH & ORP ELECTRODES

All electrodes part numbers ending in B are supplied with a BNC connector and 1 m (3.3') cable.

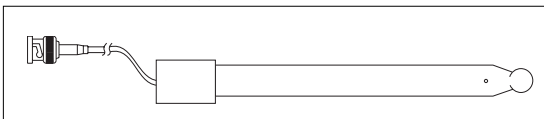

HI 1043B

Glass-body, double junction, refillable, combination pH electrode. Use: strong acid/alkali.

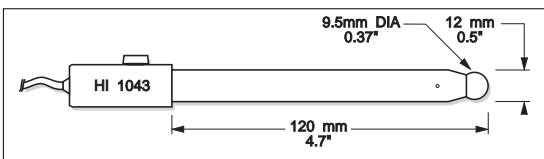

HI 1053B

Glass-body, triple ceramic, conic shape, refillable, combination pH electrode. Use: emulsions.

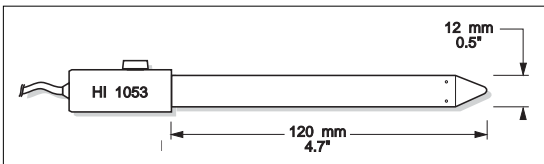

HI 1083B

Glass-body, micro, Viscolene, non-refillable, combination pH electrode. Use: biotechnology, micro titration.

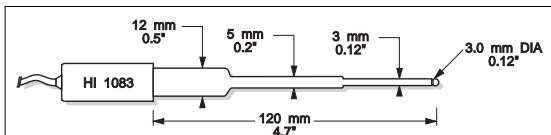

HI 1131B

Glass-body, single junction, refillable, combination pH electrode. Use: general purpose.

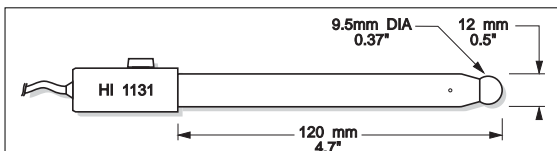

HI 1330B

Glass-body, semimicro, single junction, refillable, combination pH electrode. Use: laboratory, vials.

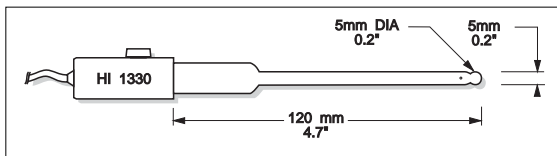

HI 1331B

Glass-body, semimicro, single junction, refillable, combination pH electrode. Use: flasks.

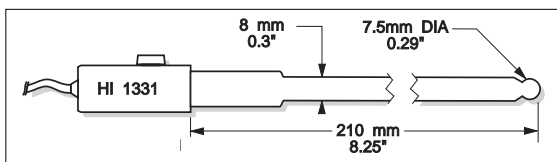

HI 1230B

Plastic-body (Ultem®), double junction, gel-filled, combination pH electrode. Use: general, field.

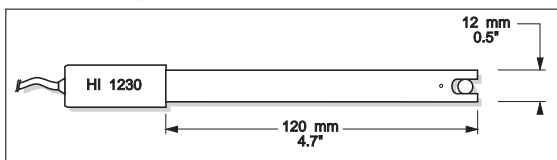

HI 2031B

Glass-body, semimicro, conic, refillable, combination pH electrode.
Use: semisolid products.

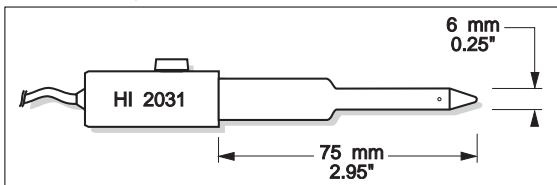

HI 1332B

Plastic-body (Ultem®), double junction, refillable, combination pH electrode.
Use: general purpose.

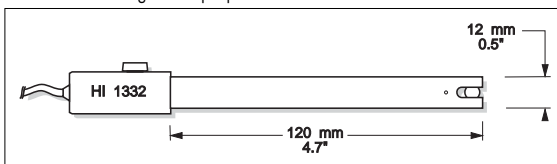

FC 100B

Plastic-body (Kynar®), double junction, refillable, combination pH electrode.
Use: general purpose for food industry.

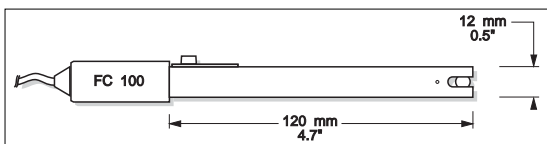

FC 200B

Plastic-body (Kynar®), open junction, conic, Viscolene, non-refillable, combination pH electrode.
Use: meat & cheese.

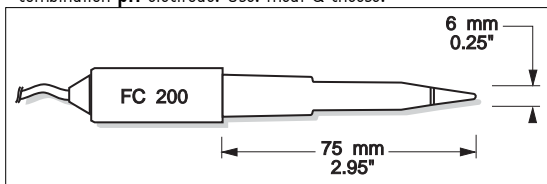

FC 210B

Glass-body, double junction, conic, Viscolene, non-refillable, combination pH electrode. Use: milk, yogurt.

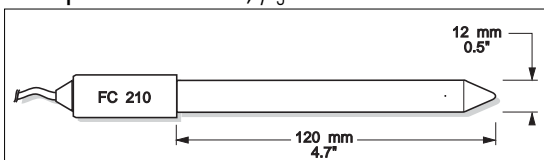

FC 220B

Glass-body, triple-ceramic, single junction, refillable, combination pH electrode. Use: food processing.

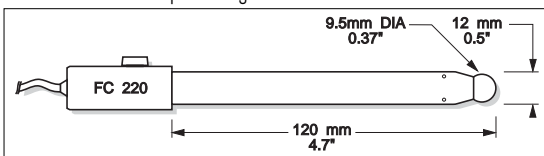

FC 911B

Plastic-body (Kynar®), double junction, refillable with built-in amplifier, combination pH electrode. Use: very high humidity.

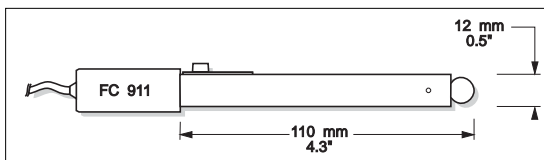

HI 1413B

Glass-body, single junction, flat tip, Viscolene, non-refillable, combination pH electrode. Use: surface measurement.

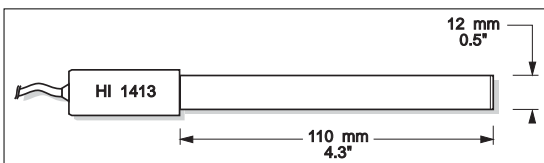

Ultem® is registered Trademark of "General Electric Co."

Kynar® is registered Trademark of "Pennwalt Corp."

ORP electrodes:

HI 3131B

Glass-body, refillable, combination platinum **ORP** electrode.

Use: titration.

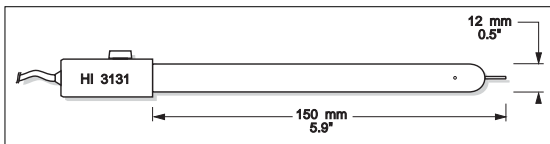

HI 3230B

Plastic-body (Ultem®), gel-filled, combination platinum **ORP** electrode. Use: general purpose.

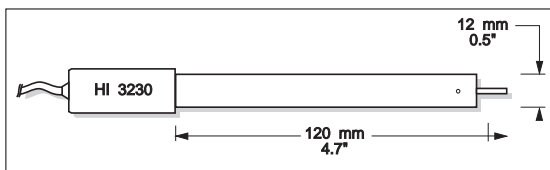

HI 4430B

Plastic-body (Ultem®), gel-filled, combination gold **ORP** electrode. Use: general purpose.

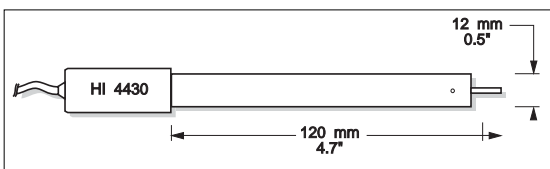

Extension cables for screw-type electrodes only (screw to BNC connector):

HI7855/1 Extension cable 1m (3.3') long

HI7855/3 Extension cable 3m (9.9') long

HI7855/5 Extension cable 5m (16.5') long

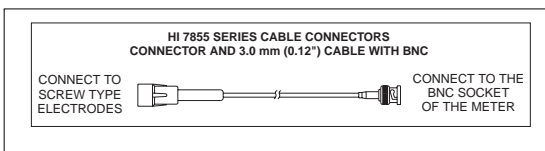

- HI7855/10** Extension cable 10m (33') long
HI7855/15 Extension cable 15m (49.5') long

Power Units:

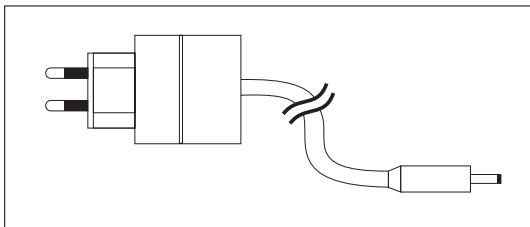

- HI710005** Voltage adapter from 115 VAC to 12 VDC
HI710006 Voltage adapter from 230 VAC to 12 VDC

OTHER ACCESSORIES

- ChecktempC** Pocket-size thermometer (range -50.0 to 150.0°C)
HI 76405 Electrode holder

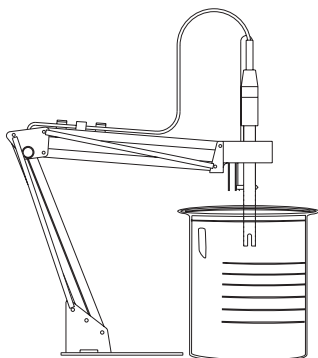

- HI 7669/2W** Temperature probe with 1 m (3.3') screened cable (not for HI 8519)
HI 8427 pH and ORP electrode simulator with 1 m (3.3') coaxial cable ending in female BNC connectors
HI 931001 pH and ORP electrode simulator with LCD and 1 m (3.3') coaxial cable ending in female BNC connectors
MANPHBNR3 Instructions manual

ELECTRODE APPLICATION REFERENCE GUIDE

Application	Electrodes
1. Aquarium	HI 1332B, HI 1911B
2. Bath-water	HI 1910B, HI 1130B
3. Beer	HI 1131B
4. Bread	HI 2031B, FC 200B
5. Cheese	FC 200B
6. Dairy products	FC 911B, FC 100B
7. Dirty water	HI 1910B, HI 1912B
8. Emulsions	HI 1053B
9. Environment	HI 1230B
10. Flasks	HI 1331B
11. Food industry general use	FC 911B, FC 100B
12. Fruit	FC 200B, FC 220B
13. Fruit juices, organic	FC 210B
14. Galvanizing waste solution	HI 1130B, HI 1912B
15. Heavy-duty applications	HI 1135B
16. High purity water	HI 1053B
17. Horticulture	HI 1053B, FC 200B
18. In-line applications	HI 1134B, HI 1135B, HI 2114B, HI 2910B
19. Laboratory general use	HI 1131B, HI 1230B, HI 1332B, HI 1330B
20. Leather	HI 1413B
21. Lemon juice	FC 100B
22. Meat	FC 200B, HI 2031B
23. Micro plate sampling of less than 100 mL	HI1083B
24. Milk and Yogurt	FC 210B
25. Paints	HI 1053B
26. Paper	HI 1413B
27. Photographic chemicals	HI 1230B
28. Quality control	HI 1332B
29. Sausages	FC 200B, HI 2031B
30. Semisolid products	HI 2031B
31. Skin	HI 1413B
32. Soil samples	HI 1230B
33. Solvents	HI 1043B
34. Strong acid	HI 1043B
35. Submersion application	HI 1130B
36. Surface measurements	HI 1413B
37. Swimming pool	HI 1130B, HI 2114B, HI 2910B
38. Titrations with constant temperature range	HI 1131B
39. Titrations with wide temperature range	HI 1131B
40. Very high humidity	FC 911B, HI 1912B, HI 1911B
41. Vials and test tube	HI 1330B
42. Wine processing	FC 220B

WARRANTY

All Hanna Instruments **meters are guaranteed for two years** against defects in workmanship and materials when used for their intended purpose and maintained according to instructions. **The electrodes and the probes are guaranteed for a period of six months.** This warranty is limited to repair or replacement free of charge.

Damage due to accident, misuse, tampering or lack of prescribed maintenance are not covered.

If service is required, contact the dealer from whom you purchased the instrument. If under warranty, report the model number, date of purchase, serial number and the nature of the failure. If the repair is not covered by the warranty, you will be notified of the charges incurred. If the instrument is to be returned to Hanna Instruments, first obtain a Returned Goods Authorization number from the Customer Service department and then send it with shipping costs prepaid. When shipping any instrument, make sure it is properly packaged for complete protection.

To validate your warranty, fill out and return the enclosed warranty card within 14 days from the date of purchase.

All rights are reserved. Reproduction in whole or in part is prohibited without the written consent of the copyright owner, Hanna Instruments Inc., 584 Park East Drive, Woonsocket, Rhode Island, 02895, USA.

Hanna Instruments reserves the right to modify the design, construction and appearance of its products without advance notice.

CE DECLARATION OF CONFORMITY



DECLARATION OF CONFORMITY

We

Hanna Instruments Srl
V.le delle industrie 12
35010 Ronchi di Villafranca (PD)
ITALY

herewith certify that the bench pH meters

HI 8417 HI 8519 HI 8520 HI 8521

have been tested and found to be in compliance with the following regulations:

IEC 801-2	Electrostatic Discharge
IEC 801-3	RF Radiated
IEC 801-4	Fast Transient
EN 55022	Radiated, Class B

Date of Issue: 20-12-1995

D. Volpato - Engineering Manager

On behalf of
Hanna Instruments S.r.l.

Recommendations for Users

Before using these products, make sure that they are entirely suitable for the environment in which they are used.

Operation of these instruments in residential area could cause unacceptable interferences to radio and TV equipment, requiring the operator to take all necessary steps to correct interferences.

The glass bulb at the end of the electrode is sensitive to electrostatic discharges. Avoid touching this glass bulb at all times.

During calibration of instruments, ESD wrist straps should be worn to avoid possible damage to the electrode by electrostatic discharge.

To maintain the EMC performance of equipment, the recommended cables noted in the user's manual must be used.

In particular cases the instruments could turn off. In such cases, turn them on by pressing the ON/OFF key.

Any variation introduced by the user to the supplied equipment may degrade the instruments' EMC performance.

To avoid electrical shock, do not use these instruments when voltages at the measurement surface exceed 24VAC or 60VDC.

To avoid damage or burns, do not perform any measurement in microwave ovens.

PRINTED IN PORTUGAL

MANPHNR3 05/98



* MANPHNR3 *



<http://www.hannainst.com>