

Bushnell®



Model: 18-0832
LIT. #: 98-0377/01-04

Instruction Manual • Manuel D'instructions
Manual de Instrucciones • Bedienungsanleitung
Manuale di Istruzioni • Manual de Instruções

ENGLISH	2-30
FRANÇAIS	31-64
ESPAÑOL	65-94
DEUTSCH	95-124
ITALIANO	125-154
PORTUGUÊS	155-186

Congratulations on your purchase of a Bushnell® ImageView® binocular. Before using the product, please read the instructions contained in this manual and take time to familiarize yourself with the different parts and features of the product.



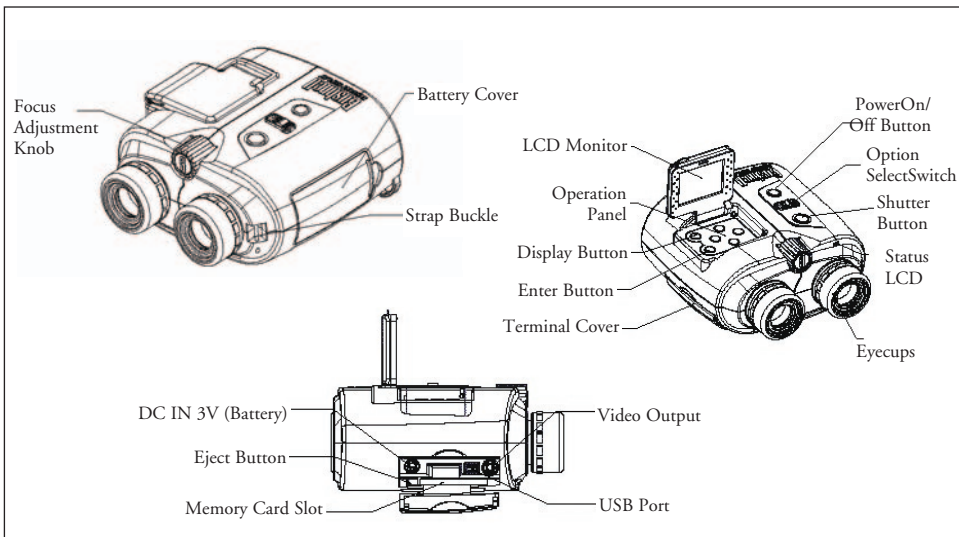

PARTS AND NAMES



SYSTEM OPERATION

Power On				Power On AC adaptor/AA Battery
Capture	Movie Capture	Playback - Still	Playback-Movie	Image/Movie Export
Push the option select switch to still camera mode.	Push the option select switch to movie mode.	Open the LCD monitor.	Open the LCD monitor.	Open the terminal cover.
Open the LCD monitor.	Open the LCD monitor.	Push the option select switch to still camera mode.	Push the option select switch to movie mode.	Use the USB cable to connect.
Adjust the focus knob.	Press the shutter button to start recording.	Press the display button.	Press the display button.	On this mode, the binocular becomes the external hard disk. Edit the movie or image(s) directly.
Press the shutter button.	Press the shutter button again to stop recording.	Use the operation panel to select an image.	Use the operation panel to select a movie.	Exit
	You can record up to a 30 second movie clip. If over 30 seconds, the binocular will keep the last 30 seconds.	Press the enter button (display function mode)	Press the enter button (display function mode)	
		1. Thumbnail 2. Magnify 3. Management 4. Set Up 5. Exit	1. Thumbnail 2. Management 3. Set Up 4. Exit	

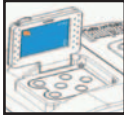
OPERATION GUIDE - Image Capture

<u>Operating Procedure</u>	<u>Picture Description</u>	<u>Binocular Action</u>
1. Press the Power Button		Use the power button to turn the binocular on and off. The LCD will turn off automatically to conserve power if it is left idle (no button or switches operated) for 2 minutes. The camera will turn off the main power to conserve energy if left idle for 5 minutes
2. Push the capture mode of the Option Select Switch to Still Camera Mode.		Now you can take images in capture mode. This procedure selects still image record/playback
3. Open the LCD Monitor		Compose images using either the monitor screen or binocular eyepieces. Focusing should always
4. Adjust the Center Focus Knob to make the image of your subject clear on the LCD monitor.		Turn the focus adjustment knob until the image on the monitor screen is clear.

Operating Procedure

5. Press the shutter button to take the picture

Picture Description



Binocular Action

The recorded image remains on the monitor for about one second, then restores the original mode.

OPERATION GUIDE - Movie Capture

Operating Procedure

1. Press the power button
2. Push the Movie mode of the option select switch to Movie mode
3. Open the LCD monitor

Picture Description

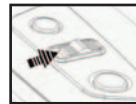

Binocular Action

Use the power button to turn the binocular on and off. The LCD will turn off automatically to conserve power if it is left idle (no button or switches operated) for 2 minutes. The camera will turn off the main power to conserve energy if left idle for 5 minutes

Now you can record movies in Movie Mode. This procedure selects movie record/playback.

Compose images using either the monitor screen or binocular eyepiece. Focusing should always be done while viewing the LCD monitor.

Operating Procedure

- Adjust the Center Focus Knob to make the image of your subject clear on the LCD monitor.
- Press the shutter button.
- Press the shutter button again.

Picture Description

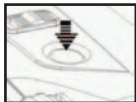
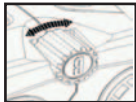





Binocular Action

Turn the focus adjustment knob until the image on the monitor screen is clear.

Start to record movies.

Finish recording movie. (The movie length is 30 seconds maximum. The Instant Replay will continue to record over the previous movie until the shutter button is pressed for a second time to stop recording. Therefore, the internal memory will always contain the most recent 30 seconds of action recorded.)

Operating Procedure

- Push the capture mode of the option select switch to Still Camera Mode
- Open the LCD monitor
- Press display button
- Use the   buttons on the operation panel to select the image to be played.
- Press the enter button for additional playback functions
- Use the   buttons on the operation panel to select the desired function

Picture Description

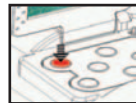
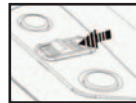

Binocular Action

Selects still image record/playback

View images using the monitor screen.

The recorded image is displayed on the monitor

Display the previous or next image stored in the binocular.

Playback Function items appear on the right of the screen

Select the function on the screen.

OPERATION GUIDE - Playback Recorded Images

Operating Procedure

- Press the power button

Picture Description



Binocular Action

Use the power button to turn the binocular on and off. The LCD will turn off automatically to conserve power if it is left idle (no button or switches operated) for 2 minutes. The camera will turn off the main power to conserve energy if left idle for 5 minutes

- Press the enter button

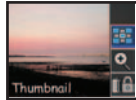

Display Function items appear on the right of the screen.

OPERATION GUIDE - Functions (Playback Recorded Images)

Operating Procedure **Thumbnail Function**



- Use the buttons of the operation panel to select a specific image.
- Press the enter button
- Press the enter button

Picture Description



Binocular Action

This displays 9 images on the monitor at the same time.

The currently selected image will be framed (highlighted).

The specific image file is displayed on the monitor screen.

Restore playback images mode

Operating Procedure **Magnify Function**



- Press the enter button
- Use the buttons of the panel to move the display area vertically or horizontally

Picture Description



- Press the enter button



Binocular Action

Display the recorded image.

Display the enlarged image currently.

Zoom in on the image:
 "Up Arrow": The image moves up
 "Down Arrow": Image moves down
 "Left Arrow": Image moves left
 "Right Arrow": Image moves right

Restore playback images mode

Operating Procedure
Delete and Lock Function



1. Use the buttons on the operation panel to select the managing file option
2. Press the enter button

Picture Description

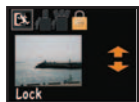
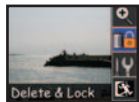

Binocular Action

Display the file management screen

Use the “Up Arrow” and “Down Arrow” buttons to select the images. Use the “Left Arrow” and “Right Arrow” buttons to select [Exit – Delete – Lock] option

Go back to playback images mode

Set-Up Function



1. Press the display button
2. Press the enter button



You cannot enter the Set-Up Function if no memory card is inserted

Display the setting screen

If a memory card has been inserted, press the enter button, then use the direction arrow buttons to select the settings

Operating Procedure
Set-Up Function - cont'd
Time and Date

1. Use the buttons on the operation panel to set the Time and Date
2. Press the enter button

Picture Description

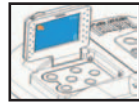
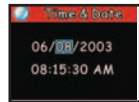
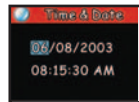

Binocular Action

The Time and Date Setting shows on the screen. Change the number at the highlighting position.

Use the “Left Arrow” and “Right Arrow” buttons to select the highlighting position. And use the “Up Arrow” and “Down Arrow” buttons to change the number.

Go back to still image playback mode

Format CF

1. Use the buttons on the operation panel to select Yes or No.
2. Press the enter button

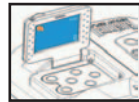
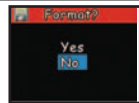



The “Format CF” setting shows on the screen. Set items at the highlighting position.

Yes – Format CF Card
 No – Cancel Format

Go back to image playback mode

Operating Procedure

Video Out

1. Use the   buttons on the operation panel to select the Video Out setting
2. Press the enter button

Picture Description

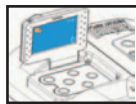

Binocular Action



The Video Out setting shows on the screen. The default is NTSC (US/Japan video standard)

Choose PAL if applicable to your country (most European and Asian countries)

Go back to image playback mode.

Operating Procedure

Sound

1. Use the   buttons on the operation panel to select sound setting.
2. Press the enter button

Picture Description

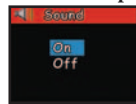



Binocular Action

The key sound setting shows on the screen. The default is on.

The key sound setting shows on the screen. The current setting is off.

Go back to playback images Mode

Resolution

1. Use the   buttons on the operation panel to select resolution setting.
2. Press the enter button

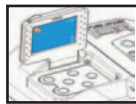



The resolution setting shows on the screen. The default is 1600x1200.

The resolution setting shows on screen. The current setting is 800x600.

Go back to playback images mode

Panel Brightness

1. Use the   buttons on the operation panel to select resolution setting.
2. Press the enter button

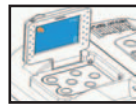

The panel brightness setting shows on the screen. The current brightness is identified by the arrowhead.

The panel brightness is controlled by the arrowhead.

Go back to playback images mode

Restore the capture mode

OPERATION GUIDE - Playback Recorded Movies

Operating Procedure

1. Press the power button

Picture Description



Binocular Action

Use the power button to turn the binocular on and off. The LCD will turn off automatically to conserve power if it is left idle (no button or switches operated) for 2 minutes. The camera will turn off the main power to conserve energy if left idle for 5 minutes.

2. Push the Movie mode of the option select switch to Movie Mode



Selects Movie record/playback

3. Open the LCD monitor

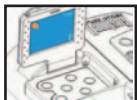

View movie using the monitor screen.

4. Press display button



The recorded movie is displayed on the monitor

Operating Procedure

5. Use the "Right Arrow" button on the operation panel to play the movie

Picture Description



6. Press the enter button

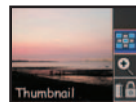

Binocular Action

Monitor screen is playing. When the movie is finished it will return to the last scene.

Display Function items appear on the right of the screen

OPERATION GUIDE - Functions (Playback Recorded Movies)

Thumbnail Function



1. Use the buttons of the operation panel to select the movie.



This displays 9 movies on the monitor at the same time.

2. Press the enter button







The currently selected movie will be framed (highlighted).



The recorded movie is displayed on the monitor screen.

Operating Procedure

3. Use the  button on the operation panel to play the movie.
4. Use the   buttons to select the movie
5. Use the  button on the operation panel to play the movie
6. Press the enter button

Picture Description



Binocular Action

The monitor displays “Loading Movie” for about 1 second and then plays the movie

The recorded movie is displayed on the monitor

The monitor displays “Loading Movie” for about 1 second and then plays the movie

Go back to movie playback mode

Operating Procedure **Delete and Lock Function**



1. Use the buttons on the operation panel to select the managing file option
2. Press the enter button

Picture Description

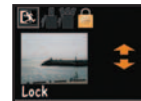
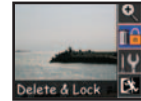

Binocular Action

Display the file management screen

Use the   buttons to select the movie. Use the   buttons to select [Exit-Delete-Lock] option

Go back to movie playback mode

Set-Up Function



1. Press the display button
2. Press the enter button



You can't enter the Set-Up Function if no memory card is inserted

Display the setting screen

If a memory card has been inserted, press the enter button, then use the direction arrow buttons to select the settings

Operating Procedure

Time and Date

1. Use the buttons on the operation panel to set the Time and Date
2. Press the enter button mode

Picture Description

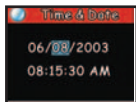



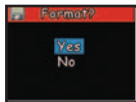
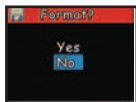

Format CF

1. Use the buttons on the operation panel to select Yes or No.
2. Press the enter button



Binocular Action

The Time and Date Setting shows on the screen. Change the number at the highlighting position.

Use the   buttons to select the highlighting position. And use the   buttons to change the number.

Go back to still movie playback



The “Format CF” setting shows on the screen. Set items at the highlighting position.

Yes – Format CF Card
No – Cancel Format

Go back to movie playback mode

Operating Procedure



Video Out

1. Use the   buttons on the operation panel to select the Video Out setting
2. Press the enter button

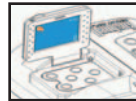
Picture Description



Resolution

1. Use the   buttons on the operation panel to select resolution setting.
2. Press the enter button

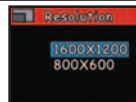

Binocular Action

The Video Out setting shows on the screen. The default is NTSC (US/Japan video standard)

Choose PAL if applicable to your country (most European and Asian countries)

Go back to movie playback mode.

The resolution setting shows on the screen. The default is 1600x1200.

The resolution setting shows on screen. The current setting is 800x600.

Go back to movie playback mode

Operating Procedure

Picture Description

Binocular Action

Operating Procedure

Picture Description

Binocular Action

Sound

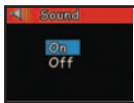

The key sound setting shows on the screen. The default is on.

Panel Brightness



The panel brightness setting shows on the screen. The current brightness is identified by the arrowhead.

1. Use the   buttons on the operation panel to select sound setting.

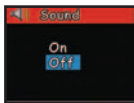

The key sound setting shows on the screen. The current setting is off.

1. Use the   buttons on the operation panel to select resolution setting.



The panel brightness is controlled by the arrowhead.

2. Press the enter button



Go back to movie playback Mode

2. Press the enter button



Go back to movie playback Mode

Exit



Restore the movie capture mode

OPERATION GUIDE - Play Back on Television

Operating Procedure

Picture Description

Binocular Action

1. Connect to the TV



Make sure that the power of TV and camera are turned off.

2. Open terminal cover of the device and connect video cable to AV out port.

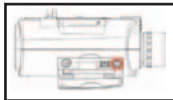

3. Connect the other end of video cable to the video in port on the TV



4. Connect to the AC adaptor (or battery)



5. Press the Power button



6. Press the TV power



Disconnect:

1. Make sure the camera power is turned off.
2. Remove the video cable.



OPERATION GUIDE - Low Battery Status

1. Press the Power button



2. If the battery capacity goes low, the battery symbol on the screen will flash, a warning beep will be sent out and LED will flash.



3. If the batteries go dead, the battery symbol will appear on the screen and the device will send out a warning beep. Please recharge the battery immediately.



BINOCULAR INSTRUCTIONS - IPD Adjustment (Eye Spacing Adjustment)

Operating Procedure

Picture Description

Binocular Action

How to Adjust for Distance Between Your Eyes – The distance between the eyes, called Interpupillary Distance (IPD), varies from person to person. To achieve perfect alignment of the lens to the eye, follow these simple steps.

1. Hold your binocular in the normal viewing position
2. Grasping your binocular firmly, move it horizontally until you see a single circular field.

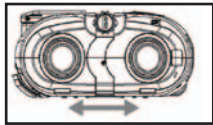
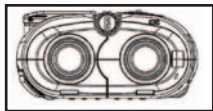

According to the user's interpupillary distance, adjust for the distance between your eyes

Your binocular is fitted with eyecups designed for your comfort and to exclude extraneous light.

BINOCULAR INSTRUCTIONS - Diopter Adjustment (Focusing)

How to Adjust for Individual Eye Strength – As individual eyesight varies from one person to another, most binoculars have a diopter setting feature which allows you to fine-tune the binoculars to your vision. The camera and binocular are set up to be in focus for people with 20/20 vision or corrected vision. You may need to adjust the left eye to match the camera as well as the right eye as you would do with most binoculars. Follow the focusing instructions below for your type of binocular.

Operating Procedure

- a. Press the power button

Picture Description



- b. Adjust the interpupillary distance

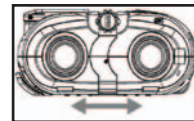

- c. Open the LCD monitor



- d. Adjust the Focus adjustment knob to make the image clear

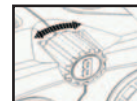

- e. Look through binocular at the same object that the camera is focused on. If the object is clear for you left eye proceed to step g and then h. If object is not clear in the left eye proceed to step f and then g and h.

Binocular Action

Use the power button to turn the binocular on and off. The binocular will turn off automatically to conserve power if it is left idle (no button or switches operated) for 2 minutes.

According to the user's interpupillary distance, adjust for distance between your eyes

Compose images using wither the monitor screen or the binocular eyepieces

Turn the focus adjustment knob until the image on the monitor screen is clear.

Operating Procedure

f. Turn the screw to relax with a screw driver

Picture Description

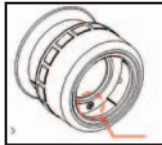

g. Adjust left eye slightly.

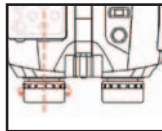

h. Adjust the right eye slightly.

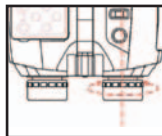

After adjusting, you can see objects clearly. A different user can adjust to fit his or her needs. The binocular is now set up for your individual eye sight. The eyepiece adjustments will not affect the camera focus.

Binocular Action

Allow your eyesight to adjust slightly (Left eye first)

Adjust the diopter to find the clearest focus

Adjust to find the clearest focus
If both barrels of the binocular are in sync with the each other and with the camera, than you only have to turn the center focus knob to adjust the focus for all three.

Connecting to PC Instructions (Install CD)

If your computer system is Windows ME, Win2000, or Win XP, please skip over this process (the drive is only necessary for Windows 98)

Operating Procedure

1. Turn your computer on.
2. Put the CD into CD-Rom and system will auto-run.
3. Select "Install Driver" to install software. This will install the driver on your computer.
4. Select "Next" to continue.
5. Select the item to install and click the "Install" icon on your computer monitor.
6. Select the item to complete. Exit the install image. Click on the Finish Icon.

Picture Description

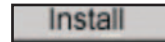

Binocular Action

Your computer monitor will show the Install image.

Your computer monitor will show a welcome image.

YOU WILL NEED TO RESTART YOUR COMPUTER AFTER INSTALLATION IS FINISHED AND BEFORE CONNECTION CAMERA AND USB CABLE.

Connecting to PC Instructions (USB Connection)

Operating Procedure

a. Connect the USB cable securely from the Instant Replay USB port to your computer.

Picture Description

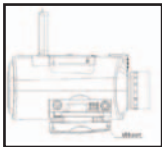

b. Press the Power button on the Instant Replay.



c. The Instant Replay will be recognized as a new (USB) storage device, essentially no different from an external hard drive, which contains your still image and movie files. Using Windows Explorer or “My Computer”, you may view the contents of the Instant Replay CF card/internal memory, clicking on any of the files to view your images and movies. You may save them to your internal hard drive individually, after opening and viewing them in Microsoft Photo Editor or another graphics program. Or you may wish to select some or all of the Instant Replay’s files in Explorer and drag or copy/paste them to a folder on your hard drive, just as you would any normal files.

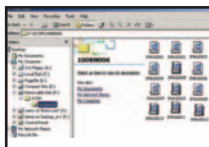
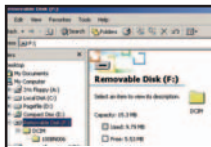

Binocular Action

The PC window will show “A New Hard Disk Is Found”
On this mode the binocular becomes the external hard disk –
Edit the movies and images directly

Operating Procedure

3. Transfer the movies and images to the computer

4. Exit

Picture Description



Binocular Action

The monitor shows that it is transferring the files to the selected folder

Pick the icon of task tray on your computer screen and select exit to disconnect the USB cable.

TWO-YEAR LIMITED WARRANTY

Your Bushnell® product is warranted to be free of defects in materials and workmanship for two years after the date of purchase. In the event of a defect under this warranty, we will, at our option, repair or replace the product, provided that you return the product postage prepaid. This warranty does not cover damages caused by misuse, improper handling, installation, or maintenance provided by someone other than a Bushnell Authorized Service Department.

Any return made under this warranty must be accompanied by the items listed below:

- 1) A check/money order in the amount of \$10.00 to cover the cost of postage and handling
- 2) Name and address for product return
- 3) An explanation of the defect
- 4) Proof of Date Purchased
- 5) Product should be well packed in a sturdy outside shipping carton, to prevent damage in transit, with return postage prepaid to the address listed below:

IN U.S.A. SEND TO:

Bushnell Performance Optics
Attn.: Repairs
8500 Marshall Drive
Lenexa, Kansas 66214

IN CANADA SEND TO:

Bushnell Performance Optics
Attn.: Repairs
25A East Pearce Street, Unit 1
Richmond Hill, Ontario L4B 2M9

For products purchased outside the United States or Canada please contact your local dealer for applicable warranty information. In Europe you may also contact Bushnell at:

BUSHNELL Performance Optics Gmbh
European Service Centre
MORSESTRASSE 4
D- 50769 KÖLN
GERMANY
Tél: +49 (0) 221 709 939 3
Fax: +49 (0) 221 709 939 8

This warranty gives you specific legal rights.
You may have other rights which vary from country to country.
©2004 Bushnell Performance Optics

Bushnell®

FRANÇAIS



Model: 18-0832
LIT. #: 98-0377/01-04

Manuel D'instructions

Merci de votre achat de jumelles Bushnell. C'est un instrument de précision conçu pour fournir de nombreuses années de service agréable. Ce manuel vous permettra d'en obtenir les performances optimales car il explique comment le régler en fonction des yeux de l'utilisateur et comment en prendre soin. Veuillez lire attentivement ce mode d'emploi avant d'utiliser les jumelles.

IDENTIFICATION DES PIÈCES

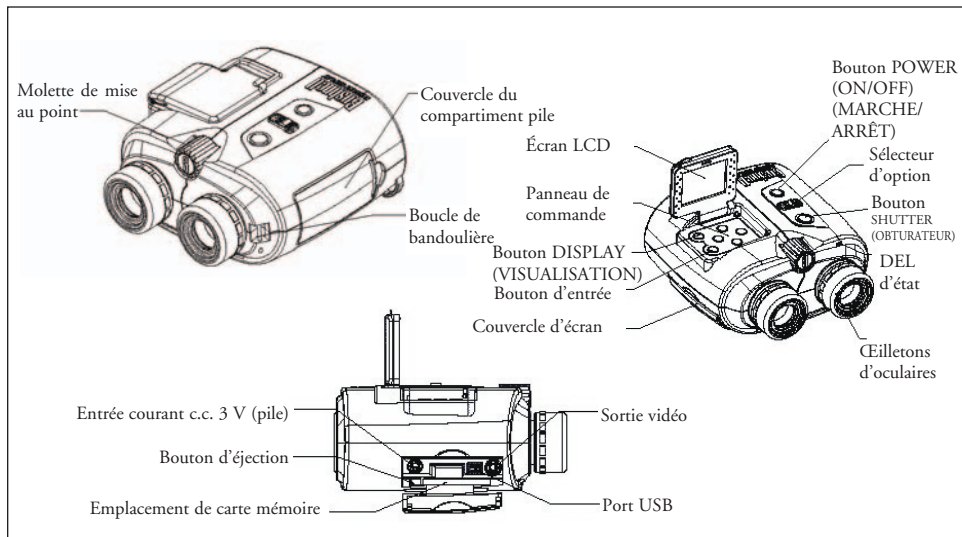

Mise sous tension

Mise sous tension
(adaptateur c.a./pile AA)

Saisie	Saisie de films	Lecture (mode Appareil photo)	Lecture (mode Film)	Exportation d'une image/d'un film
Poussez le sélecteur d'option sur le mode Appareil photo.	Poussez le sélecteur d'option sur le mode Film.	Ouvrez l'écran LCD.	Ouvrez l'écran LCD.	Ouvrez l'écran LCD.
Ouvrez l'écran LCD.	Ouvrez l'écran LCD.	Poussez le sélecteur d'option sur le mode Appareil photo.	Poussez le sélecteur d'option sur le mode Film.	Utilisez le câble USB pour connecter.
Réglez la molette de mise au point.	Appuyez sur le bouton SHUTTER (OBTURATEUR) pour commencer à enregistrer.	Appuyez sur le bouton DISPLAY (VISUALISATION).	Appuyez sur le bouton DISPLAY (VISUALISATION).	(Dans ce mode, les jumelles deviennent le disque dur externe. Éditez le film ou l'image directement).
Appuyez sur le bouton SHUTTER (OBTURATEUR).	Appuyez de nouveau sur le bouton SHUTTER (OBTURATEUR) pour arrêter d'enregistrer. (Vous pouvez enregistrer une séquence filmée d'une durée maximale de 30 secondes. Si vous enregistrez pendant plus de 30 secondes, l'instrument ne conservera que les 30 dernières secondes).	Utilisez le panneau de commande pour sélectionner l'image.	Utilisez le panneau de commande pour sélectionner le film.	Sortez.
		Appuyez sur le bouton d'entrée (mode visualisation des fonctions).	Appuyez sur le bouton d'entrée (mode visualisation des fonctions).	
		1. Miniature 2. Grossir 3. Gestion 4. Configuration 5. Sortir 6. Sortez	1. Miniature 2. Gestion 3. Configuration 4. Sortir 5. Sortez	

GUIDE D'UTILISATION - Saisie d'images

Mode d'emploi

1. Appuyez sur le bouton POWER (MARCHE/ARRÊT)

Description de l'image



2. Poussez le sélecteur d'option vers le mode Appareil photo pour la saisie.



3. Ouvrez l'écran LCD.



Action sur les jumelles

Utilisez le bouton POWER (MARCHE/ARRÊT) pour mettre les jumelles sous tension et hors tension. LCD se mettent automatiquement hors tension pour conserver l'énergie des piles si elles sont laissées au repos (aucun bouton ou aucune commande n'est actionné(e)) pendant 2 minutes. S'il est laissé au repos pendant 5 minutes, l'appareil photo coupe l'alimentation principale pour économiser l'énergie.

Action sur les jumelles – Vous pouvez maintenant prendre des images en mode de saisie. Cette opération sélectionne l'enregistrement/la lecture d'images fixes.

Composez des images en utilisant soit l'écran soit les oculaires des jumelles. La mise au point doit toujours se faire en regardant l'écran LCD.

Mode d'emploi

4. Réglez la molette de mise au point afin que l'image du sujet soit claire sur l'écran LCD.
5. Appuyez sur le bouton SHUTTER (OBTURATEUR) pour prendre la photo.

Description de l'image

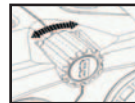

Action sur les jumelles

Tournez la molette de mise au point jusqu'à ce que l'image vue sur l'écran soit claire.

L'image enregistrée reste sur l'écran environ une seconde puis l'instrument revient au mode initial.

GUIDE D'UTILISATION - Saisie de films

Mode d'emploi





1. Appuyez sur le bouton POWER (MARCHE/ARRÊT).

Description de l'image



Action sur les jumelles

Utilisez le bouton POWER (MARCHE/ARRÊT) pour mettre les jumelles sous tension et hors tension. LCD se mettent automatiquement hors tension pour conserver l'énergie des piles si elles sont laissées au repos (aucun bouton ou aucune commande n'est actionné(e)) pendant 2 minutes. S'il est laissé au repos pendant 5 minutes, l'appareil photo coupe l'alimentation principale pour économiser l'énergie.

- | | <u>Description de l'image</u> | <u>Action sur les jumelles</u> |
|--|---|---|
| 2. <u>Mode d'emploi</u>
Poussez le sélecteur d'option vers le mode Film. |  | Vous pouvez maintenant enregistrer une séquence filmée en mode Film. Cette opération sélectionne l'enregistrement/la lecture de séquences filmées. |
| 3. Ouvrez l'écran LCD. |  | Composez des images en utilisant soit l'écran soit les oculaires des jumelles. La mise au point doit toujours se faire en regardant l'écran LCD. |
| 4. Réglez la molette de mise au point afin que l'image du sujet soit claire sur l'écran LCD. |  | Tournez la molette de mise au point jusqu'à ce que l'image vue sur l'écran soit claire. |
| 5. Appuyez sur le bouton SHUTTER (OBTURATEUR). |  | Commencez à enregistrer des séquences filmées. |
| 6. Appuyez de nouveau sur le bouton SHUTTER (OBTURATEUR). | | Finissez d'enregistrer la séquence filmée. (La durée maximum de la séquence filmée est de 30 secondes). L'Instant Replay continue à enregistrer par-dessus l'ancienne |

- | <u>Mode d'emploi</u> | <u>Description de l'image</u> | <u>Action sur les jumelles</u> |
|--|---|--|
| 1. Appuyez sur le bouton POWER (MARCHE/ARRÊT). |  | Utilisez le bouton POWER (MARCHE/ARRÊT) pour mettre les jumelles sous tension et hors tension. LCD se mettent automatiquement hors tension pour conserver l'énergie des piles si elles sont laissées au repos (aucun bouton ou aucune commande n'est actionné(e)) pendant 2 minutes. S'il est laissé au repos pendant 5 minutes, l'appareil photo coupe l'alimentation principale pour économiser l'énergie. |

GUIDE D'UTILISATION - Lecture des images enregistrées

- | <u>Mode d'emploi</u> | <u>Description de l'image</u> | <u>Action sur les jumelles</u> |
|--|---|--|
| 1. Appuyez sur le bouton POWER (MARCHE/ARRÊT). |  | Utilisez le bouton POWER (MARCHE/ARRÊT) pour mettre les jumelles sous tension et hors tension. LCD se mettent automatiquement hors tension pour conserver l'énergie des piles si elles sont laissées au repos (aucun bouton ou aucune commande n'est actionné(e)) pendant 2 minutes. S'il est laissé au repos pendant 5 minutes, l'appareil photo coupe l'alimentation principale pour économiser l'énergie. |

Mode d'emploi

2. Poussez le sélecteur d'option vers le mode Appareil photo pour la saisie.

Description de l'image

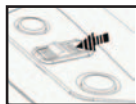



3. Ouvrez l'écran LCD.

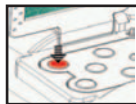

4. Appuyez sur le bouton DISPLAY (VISUALISATION).



5. Utilisez les boutons   du panneau de commande pour sélectionner l'image à visionner.



6. Appuyez sur le bouton d'entrée pour d'autres fonctions de lecture.

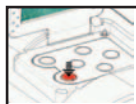

Action sur les jumelles

Sélectionne l'enregistrement/la lecture d'images fixes.



Visionnez les images sur l'écran LCD.

l'image enregistrée est affichée sur l'écran.

Affiche l'image précédente ou suivante qui est enregistrée dans les jumelles.

Les fonctions de lecture apparaissent du côté droit de l'écran.

Mode d'emploi

7. Utilisez les boutons   du panneau de commande pour sélectionner la fonction souhaitée.

Description de l'image



8. Appuyez sur le bouton d'entrée.

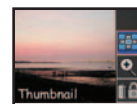

Action sur les jumelles

Sélectionne la fonction sur l'écran.

Les fonctions apparaissent du côté droit de l'écran.

GUIDE D'UTILISATION - Fonctions

Mode d'emploi

Fonction miniature (icône qui apparaît sur l'écran LCD)



Description de l'image



Action sur les jumelles

9 images apparaissent simultanément sur l'écran.

1. Utilisez les boutons du panneau de commande pour sélectionner une image spécifique.



L'image sélectionnée est encadrée (en surbrillance).

- **Mode d'emploi**

2. Appuyez sur le bouton d'entrée.

Description de l'image



Action sur les jumelles

Le fichier de l'image spécifique est affiché sur l'écran.

3. Appuyez sur le bouton d'entrée.



Restaure le mode de lecture d'images.

Fonction de grossissement (icône qui apparaît sur l'écran LCD)



1. Appuyez sur le bouton d'entrée.



Affiche l'image enregistrée.

2. Utilisez les boutons du panneau de commande pour déplacer verticalement ou horizontalement la partie affichée.



Affiche l'image sélectionnée agrandie.



Flèche vers le haut : L'image se déplace vers le haut. Flèche vers le bas : L'image se déplace vers le bas. Flèche vers la gauche : L'image se déplace vers la gauche. Flèche vers la droite : L'image se déplace vers la droite.

- **Mode d'emploi**

3. Appuyez sur le bouton d'entrée.

Description de l'image



Action sur les jumelles

Restaure le mode de lecture d'images.

Fonction d'effacement et de verrouillage (icône qui apparaît sur l'écran LCD)



1. Utilisez les boutons du panneau de commande pour sélectionner l'option de gestion des fichiers.

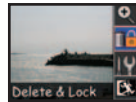

Affiche l'écran de gestion des fichiers

2. Appuyez sur le bouton d'entrée.

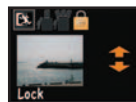

Utilisez les boutons « flèche vers le haut » et « flèche vers le bas » pour sélectionner les images. Utilisez les boutons « flèche vers la gauche » et « flèche vers la droite » pour sélectionner l'option [Exit – Delete – Lock] (Sortir - Effacer - Verrouiller).



Retournez au mode de lecture d'images.

- Mode d'emploi

Fonction Configuration

(icône qui apparaît sur l'écran LCD)



1. Appuyez sur le bouton DISPLAY (VISUALISATION). Display the setting screen
2. Appuyez sur le bouton d'entrée.

Description de l'image

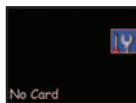

Heure et date

1. Utilisez les boutons du panneau de commande pour régler l'heure et la date.

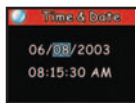
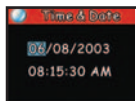

Action sur les jumelles

Il n'est possible d'accéder à la fonction Configuration que si une carte mémoire est insérée.

Affiche l'écran de configuration.

Si une carte mémoire a été insérée, appuyez sur le bouton d'entrée puis utilisez les boutons des flèches pour sélectionner les réglages.

Le réglage de l'heure et de la date apparaît sur l'écran. Changez le nombre à la position en surbrillance.

Utilisez les boutons « flèche vers la gauche » et « flèche vers la droite » pour sélectionner la position en surbrillance. Utilisez les boutons « flèche vers le haut » et « flèche vers le bas » pour changer le nombre.

- Mode d'emploi

2. Appuyez sur le bouton d'entrée.

Description de l'image

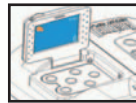

Format CF

1. Utilisez les boutons du panneau de commande pour sélectionner Yes (oui) ou No (non).
2. Appuyez sur le bouton d'entrée.

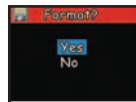
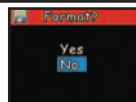

Sortie vidéo



Action sur les jumelles

Retournez au mode de lecture d'images.



Le réglage "Format CF" apparaît sur l'écran. Effectuez le réglage à la position en surbrillance.

Yes – carte Format CF
No – Annuler le Format

Retournez au mode de lecture d'images.

Le réglage de la sortie vidéo apparaît sur l'écran. Le réglage par défaut est NTSC (norme vidéo des États-Unis/du Japon).

- **Mode d'emploi**

1. Utilisez les boutons   du panneau de commande pour sélectionner le réglage de la sortie vidéo.

Description de l'image



2. Appuyez sur le bouton d'entrée.

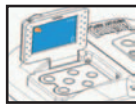

Action sur les jumelles

Choisissez PAL si cette norme vidéo est applicable dans le pays où vous vous trouvez (la plupart des pays d'Europe et d'Asie).

Retournez au mode de lecture d'images.

Résolution

1. Utilisez les boutons   du panneau de commande pour sélectionner le réglage de la résolution.



2. Appuyez sur le bouton d'entrée.

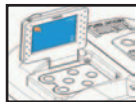
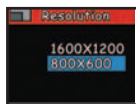



Le réglage de la résolution apparaît sur l'écran. Le réglage par défaut est 1600 x 1200.

Le réglage de la résolution apparaît sur l'écran. Le réglage courant est 800 x 600.

Retournez au mode de lecture d'images.

- **Mode d'emploi**
Son

1. Utilisez les boutons   du panneau de commande pour sélectionner le réglage du son.

2. Appuyez sur le bouton d'entrée.

Description de l'image

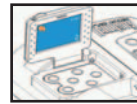
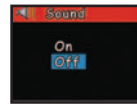
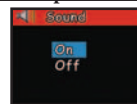



Action sur les jumelles

Le réglage du son apparaît sur l'écran. Le réglage par défaut est Activé.

Le réglage du son apparaît sur l'écran. Le réglage actuel est Désactivé

Retournez au mode de lecture d'images.

Luminosité de l'écran

1. Utilisez les boutons   du panneau de commande pour sélectionner le réglage de la luminosité.



Le réglage de la luminosité de l'écran apparaît sur l'écran. La luminosité actuelle est identifiée par la tête de flèche.

La luminosité de l'écran est contrôlée par la tête de flèche.

- **Mode d'emploi**

2. Appuyez sur le bouton d'entrée.

Description de l'image

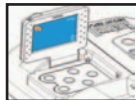

Action sur les jumelles

Retournez au mode de lecture d'images.

Sortez

GUIDE D'UTILISATION - Lecture des films enregistrés

- **Mode d'emploi**

1. Appuyez sur le bouton POWER (MARCHE/ARRÊT).

Description de l'image



Action sur les jumelles

Utilisez le bouton POWER (MARCHE/ARRÊT) pour mettre les jumelles sous tension et hors tension. LCD se mettent automatiquement hors tension pour conserver l'énergie des piles si elles sont laissées au repos (aucun bouton ou aucune commande n'est actionné(e)) pendant 2 minutes. S'il est laissé au repos pendant 5 minutes, l'appareil photo coupe l'alimentation principale pour économiser l'énergie.

2. Poussez le sélecteur d'option vers le mode Film.



Sélectionne l'enregistrement/la lecture de films.

- **Mode d'emploi**

3. Ouvrez l'écran LCD.

Description de l'image

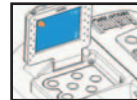

4. Appuyez sur le bouton DISPLAY (VISUALISATION).



5. Utilisez le bouton « flèche vers la droite » du panneau de commande pour visionner le film.



6. Appuyez sur le bouton d'entrée droit de l'écran.

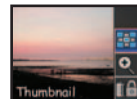

Action sur les jumelles

Visionnez le film sur l'écran LCD.

le film enregistré est affiché sur

Le film se déroule à l'écran. Lorsque la lecture du film est terminée, l'instrument reste à la dernière scène.

Les fonctions apparaissent du côté

GUIDE D'UTILISATION - Fonctions

- **Mode d'emploi**

Fonction miniature
(icône qui apparaît sur l'écran LCD)



Description de l'image



Action sur les jumelles

9 films apparaissent simultanément sur l'écran.

- Mode d'emploi

1. Utilisez les boutons du panneau de commande pour sélectionner un film.

Description de l'image





2. Appuyez sur le bouton d'entrée.



3. Utilisez le bouton  du panneau de commande pour visionner le film.



4. Utilisez les boutons   pour sélectionner le film.



5. Utilisez le bouton  du panneau de commande pour visionner le film.



Action sur les jumelles

Le film sélectionné est encadré (en surbrillance).

le film enregistré est affiché sur l'écran.

L'écran indique "Loading Movie" (chargement du film) pendant environ 1 seconde puis le film apparaît.

le film enregistré est affiché sur l'écran.

L'écran indique "Loading Movie" (chargement du film) pendant environ 1 seconde puis le film apparaît.

- Mode d'emploi

6. Appuyez sur le bouton d'entrée.

Description de l'image



Fonction d'effacement et de verrouillage (icône qui apparaît sur l'écran LCD)



1. Utilisez les boutons du panneau de commande pour sélectionner l'option de gestion des fichiers.

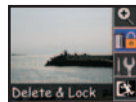

2. Appuyez sur le bouton d'entrée.





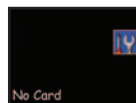

Fonction Configuration (icône qui apparaît sur l'écran LCD)



Action sur les jumelles

Retournez au mode de lecture de films.

Affiche l'écran de gestion des fichiers

Utilisez les boutons   pour sélectionner le film.
Utilisez les boutons   pour sélectionner l'option [Exit - Delete - Lock] (Sortir - Effacer - Verrouiller).

Retournez au mode de lecture de films.

Il n'est possible d'accéder à la fonction Configuration que si une carte mémoire est insérée.

- **Mode d'emploi**

1. Appuyez sur le bouton DISPLAY (VISUALISATION).

Description de l'image



2. Appuyez sur le bouton d'entrée.



Action sur les jumelles

Affiche l'écran de configuration.

Si une carte mémoire a été insérée, appuyez sur le bouton d'entrée puis utilisez les boutons des flèches pour sélectionner les réglages.

Heure et date

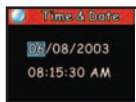

1. Utilisez les boutons du panneau de commande pour régler l'heure et la date.

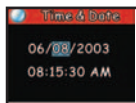

2. Appuyez sur le bouton d'entrée.



Le réglage de l'heure et de la date apparaît sur l'écran. Changez le nombre à la position en surbrillance.

Utilisez les boutons ◀ ▶ pour sélectionner la position en surbrillance. Utilisez les boutons ▲ ▼ pour changer le nombre.

Retournez au mode de lecture de films.

- **Mode d'emploi**

Format CF

Description de l'image

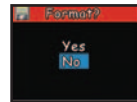

1. Utilisez les boutons du panneau de commande pour sélectionner Yes (oui) ou No (non).



2. Appuyez sur le bouton d'entrée.



Action sur les jumelles

Le réglage "Format CF" apparaît sur l'écran. Effectuez le réglage à la position en surbrillance.

Yes – carte Format CF
No – Annuler le Format

Retournez au mode de lecture de films.

Sortie vidéo



1. Utilisez les boutons ▲ ▼ du panneau de commande pour sélectionner le réglage de la sortie vidéo.



Le réglage de la sortie vidéo apparaît sur l'écran. Le réglage par défaut est NTSC (norme vidéo des États-Unis/du Japon).

Choisissez PAL si cette norme vidéo est applicable dans le pays où vous vous trouvez (la plupart des pays d'Europe et d'Asie).

- **Mode d'emploi**

2. Appuyez sur le bouton d'entrée.



Description de l'image



Action sur les jumelles

Retournez au mode de lecture de films.

Résolution

1. Utilisez les boutons   du panneau de commande pour sélectionner le réglage de la résolution.

2. Appuyez sur le bouton d'entrée.

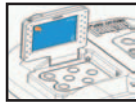

Le réglage de la résolution apparaît sur l'écran. Le réglage par défaut est 1600 x 1200.

Le réglage de la résolution apparaît sur l'écran. Le réglage courant est 800 x 600.

Retournez au mode de lecture de films.

Son

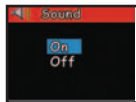

Le réglage du son apparaît sur l'écran. Le réglage par défaut est Activé.

- **Mode d'emploi**

1. Utilisez les boutons   du panneau de commande pour sélectionner le réglage du son.

2. Appuyez sur le bouton d'entrée.

Description de l'image

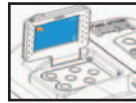
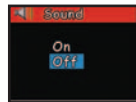



Action sur les jumelles

Le réglage du son apparaît sur l'écran. Le réglage actuel est Désactivé.

Retournez au mode de lecture de films.

Luminosité de l'écran

1. Utilisez les boutons   du panneau de commande pour sélectionner le réglage de la luminosité.

2. Appuyez sur le bouton d'entrée.

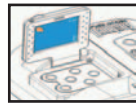

Le réglage de la luminosité de l'écran apparaît sur l'écran. La luminosité actuelle est identifiée par la tête de flèche.

La luminosité de l'écran est contrôlée par la tête de flèche.

Retournez au mode de lecture de films.

- Mode d'emploi

Sortez.

Description de l'image



Action sur les jumelles

Revenez au mode de saisie de film.

GUIDE D'UTILISATION-Lecture sur l'écran de TV

- Mode d'emploi

Connectez:

1. Connectez à la TV.

Description de l'image



Action sur les jumelles

Vérifiez que l'alimentation est coupée à la TV et à l'appareil photo.

2. Ouvrez le couvercle des sorties du dispositif et connectez le câble vidéo au port de sortie AV.

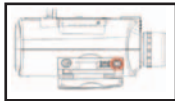

3. Connectez l'autre extrémité du câble vidéo au port d'entrée vidéo sur la TV.



- Mode d'emploi

4. Connectez à l'adaptateur c.a. (ou pile)

Description de l'image



5. Appuyez sur le bouton Power (Marche/arrêt).



6. Appuyez sur le bouton marche/arrêt de la TV.



Déconnectez:

1. Vérifiez que l'alimentation est coupée à l'appareil photo.



2. Retirez le câble vidéo.

GUIDE D'UTILISATION-État de tension insuffisante de pile

1. Appuyez sur le bouton Power (Marche/arrêt).



Action sur les jumelles

Pendant la lecture des images sur l'écran de TV, l'adaptateur c.a. peut être branché sur n'importe quelle prise de courant du bâtiment, afin d'alimenter le dispositif.

- **Mode d'emploi**

Description de l'image

Action sur les jumelles

2. Si la tension de la pile devient insuffisante, le symbole de pile clignote sur l'écran, un bip d'avertissement est émis et la LED clignote.



3. Si la tension restant dans les piles s'épuise, le symbole de pile apparaît sur l'écran et le dispositif émet un bip d'avertissement. Veuillez recharger immédiatement la pile.



GUIDE D'UTILISATION-Transfert des images

- **Mode d'emploi**

Description de l'image

Action sur les jumelles

1. Connectez fermement le câble USB entre le port USB de l'Instant Replay et l'ordinateur.

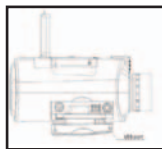

L'écran du PC doit indiquer "A New Hard Disk Is Found" (un nouveau disque dur est repéré). Dans ce mode, les jumelles deviennent le disque dur externe – Éditez les films et les images directement.

2. Appuyez sur le bouton POWER (MARCHE/ARRÊT) de l'Instant Replay.



- **Mode d'emploi**

Description de l'image

Action sur les jumelles

3. L'Instant Replay sera reconnu comme nouveau dispositif de mémorisation (USB), de manière semblable à un disque dur externe, qui contient les fichiers de vos images et films. En utilisant l'explorateur de Windows ou "Mon ordinateur", vous pouvez visualiser le contenu de la carte CF/mémoire interne de l'Instant Replay, en cliquant sur n'importe lequel des fichiers afin de voir vos images et films. Vous pouvez les sauvegarder individuellement sur le disque dur interne après les avoir ouverts et visionnés à l'aide de l'éditeur photo de Microsoft ou d'un autre programme graphique. Vous pouvez aussi sélectionner quelques-uns ou tous les fichiers de l'Instant Replay dans l'explorateur et les glisser ou copier/coller dans un répertoire du disque dur, tout comme pour des fichiers ordinaires.

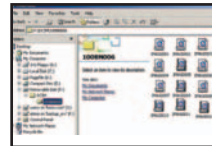
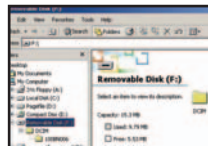

4. Transférez les films et les images vers l'ordinateur.



L'écran indique le transfert des fichiers vers le répertoire sélectionné.

- **Mode d'emploi**

- Sortez.

Description de l'image

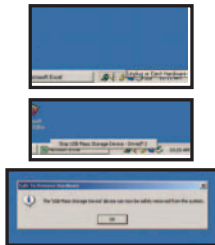

Action sur les jumelles

Choisissez l'icône de la barre de tâches sur l'écran de l'ordinateur et sélectionnez Sortie pour déconnecter le câble USB.

- **Mode d'emploi**

- Sélectionnez "Next" (suite) pour continuer.
- Sélectionnez l'article à installer et cliquez sur l'icône "Install" (Installer) de l'écran de l'ordinateur.
- Sélectionnez l'article à terminer. Sortez de la fonction d'installation. Cliquez sur l'icône de fin de tâche.

Description de l'image

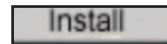

Action sur les jumelles

GUIDE D'UTILISATION-Instructions sur la connexion à un PC (Installation du CD)

Si le système d'exploitation de votre ordinateur est Windows ME, Win2000 ou Win XP, veuillez omettre cette opération (le pilote n'est nécessaire que pour Windows 98).

- **Mode d'emploi**

- Mettez votre ordinateur sous tension.
- Mettez le CD dans le lecteur de CD et le système doit s'exécuter automatiquement.
- Sélectionnez "Install Driver" (Installer le pilote) pour installer le logiciel. Cette opération installe le pilote sur votre ordinateur.

Description de l'image



Action sur les jumelles

L'écran de l'ordinateur doit représenter l'image de l'Installation.

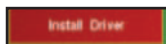

L'écran de l'ordinateur doit représenter une image de bienvenue.

VOUS DEVREZ RELANCER VOTRE ORDINATEUR UNE FOIS L'INSTALLATION TERMINÉE ET AVANT DE CONNECTER L'APPAREIL PHOTO ET LE CÂBLE USB.

GUIDE D'UTILISATION-Réglage de la distance interpupillaire (espace entre les yeux)

Comment régler pour la puissance oculaire -- Étant donné que la vision est différente pour chaque personne, la plupart des jumelles comportent un dispositif de réglage dioptrique qui permet de les régler exactement à la vision de chaque utilisateur. L'appareil photo et les jumelles sont réglés pour une mise au point convenant aux personnes ayant une vision de 20/20 ou corrigée. Il peut être nécessaire de régler l'œil gauche pour correspondre à l'appareil photo ainsi que l'œil droit, comme on le fait généralement avec les jumelles. Suivez les instructions de mise au point ci-dessous qui correspondent au type de vos jumelles.

- **Mode d'emploi**

1. Tenez les jumelles à la position normale d'observation.

Description de l'image

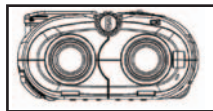

2. En saisissant fermement les jumelles, déplacez-les horizontalement de façon à voir un seul champ circulaire.



Action sur les jumelles

Selon la distance interpupillaire de l'utilisateur, réglez en fonction de la distance entre les yeux.

Pour être confortables et éliminer la lumière superflue, les jumelles disposent d'ocilletons d'oculaires.

RÉGLEZ TOUJOURS À CETTE POSITION AVANT L'UTILISATION.

GUIDE D'UTILISATION-Réglage dioptrique (mise au point)

- **Mode d'emploi**

Comment régler pour la puissance oculaire -- Étant donné que la vision est différente pour chaque personne, la plupart des jumelles comportent un dispositif de réglage dioptrique qui permet de les régler exactement à la vision de chaque utilisateur. Suivez les instructions de mise au point ci-dessous qui correspondent au type de vos jumelles.

Description de l'image



1. Appuyez sur le bouton POWER (MARCHE/ARRÊT).

Action sur les jumelles

Utilisez le bouton POWER (MARCHE/ARRÊT) pour mettre les jumelles sous tension et hors tension. Les jumelles se mettent automatiquement hors tension pour conserver l'énergie

- **Mode d'emploi**

2. Réglez la distance interpupillaire.

Description de l'image



3. Ouvrez l'écran LCD.



4. Réglez la molette de mise au point pour obtenir une image claire.

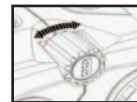

5. Regardez à travers les jumelles le même objet sur lequel l'appareil photo est mis au point. Si l'objet est clair à l'œil gauche, passez aux opérations g puis h. S'il n'est pas clair, passez à l'opération f puis aux opérations g et h.

Action sur les jumelles

des piles si elles sont laissées au repos (aucun bouton ou aucune commande n'est actionné(e)) pendant 2 minutes.

Selon la distance interpupillaire de l'utilisateur, réglez en fonction de la distance entre les yeux.

Composez des images en utilisant soit l'écran soit les oculaires des jumelles.

Tournez la molette de mise au point jusqu'à ce que l'image vue sur l'écran soit claire.

- **Mode d'emploi**

6. Dévissez la vis de verrouillage à l'aide d'un tournevis.

Description de l'image



7. Ajustez légèrement l'œil gauche.

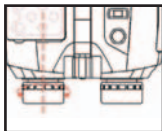

8. Ajustez légèrement l'œil droit.

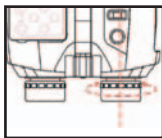

9. Si les deux cylindres des jumelles sont en synchronisation l'un avec l'autre et avec l'appareil photo, il suffit de tourner la molette centrale de mise au point pour effectuer la mise au point des trois lentilles.

Action sur les jumelles

Attendez que votre vision s'ajuste légèrement (œil gauche d'abord).

Ajustez le réglage dioptrique pour obtenir une mise au point claire.

Ajustez pour obtenir une mise au point claire.

Après le réglage, vous pouvez voir clairement les objets. Un autre utilisateur pourra effectuer les réglages selon ses besoins.

Les jumelles sont maintenant réglées en fonction de votre vision.

Les réglages d'oculaire n'affectent pas la mise au point de l'appareil photo.

GARANTIE LIMITÉE DE DEUX ANS

Votre produit Bushnell® est garanti exempt de défauts de matériaux et de fabrication pendant deux ans après la date d'achat. Au cas où un défaut apparaîtrait sous cette garantie, nous nous réservons l'option de réparer ou de remplacer le produit, à condition de nous le renvoyer en port payé. La présente garantie ne couvre pas les dommages causés par une utilisation, une manipulation, une installation incorrecte(s) ou un entretien incorrect ou fourni par quelqu'un d'autre qu'un centre de réparation agréé par Bushnell.

Tout retour effectué dans le cadre de la présente garantie doit être accompagné des articles indiqués ci-dessous :

- 1) un chèque ou mandat d'une somme de 10,00 \$ US pour couvrir les frais d'envoi et de manutention
- 2) le nom et l'adresse pour le retour du produit
- 3) une description du défaut constaté
- 4) la preuve de la date d'achat
- 5) Le produit doit être emballé soigneusement, dans un carton d'expédition solide, pour éviter qu'il ne soit endommagé durant le transport ; envoyez-le en port payé, à l'adresse indiquée ci-dessous :

AUX ÉTATS-UNIS, ENVOYEZ À:

Bushnell Performance Optics
Attn.: Repairs
8500 Marshall Drive
Lenexa, Kansas 66214

AU CANADA, ENVOYEZ À:

Bushnell Performance Optics
Attn.: Repairs
25A East Pearce Street, Unit 1
Richmond Hill, Ontario L4B 2M9

Pour les produits achetés en dehors des États-Unis et du Canada, veuillez contacter votre distributeur local pour tous renseignements concernant la garantie. En Europe, vous pouvez aussi contacter Bushnell au :

BUSHNELL Performance Optics Gmbh
European Service Centre
MORSESTRASSE 4
D- 50769 Cologne
Allemagne
Tél: +49 (0) 221 709 939 3
Fax: +49 (0) 221 709 939 8

La présente garantie vous donne des droits légaux spécifiques.

Vous pouvez avoir d'autres droits qui varient selon les pays.

©2004 Bushnell Performance Optics

Bushnell®

ESPAÑOL



18-0832
LIT. #: 98-0377/01-04

Manual de Instrucciones

Felicidades por haber comprado un binocular Bushnell, un instrumento de precisión diseñado para ofrecerle muchos años de agradables observaciones. Este manual le ayudará a lograr un rendimiento óptimo explicando cómo puede ajustar el binocular a sus ojos y cómo debe cuidar de este instrumento. Lea detenidamente las instrucciones antes de usar su binocular.

PARTES Y NOMBRES

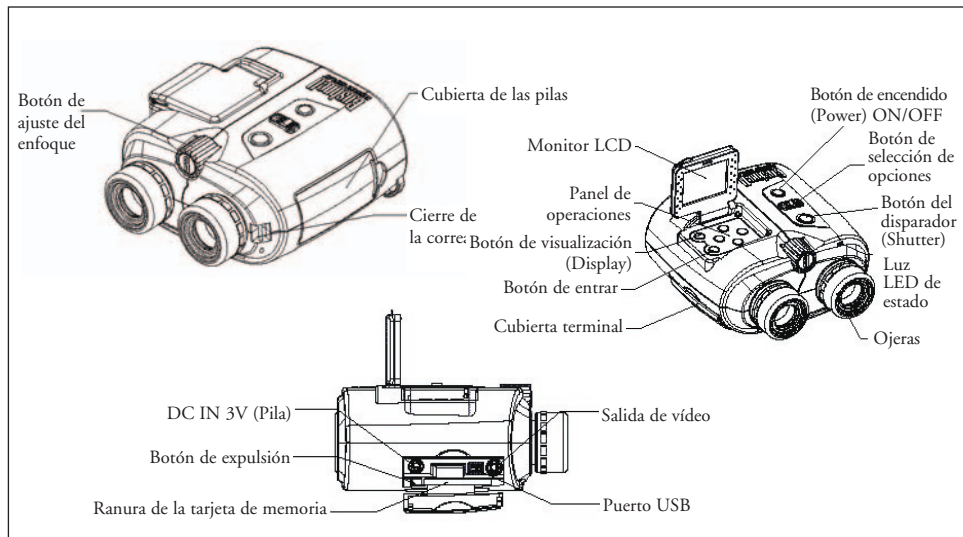

FUNCIONAMIENTO DEL SISTEMA





Encendido en posición On

Captación	Captación de película	Reproducción (modalidad de cámara estática)	Modalidad de reproducción de película
Pulse el botón de selección de opciones a la modalidad de cámara estática	Pulse el botón de selección de opciones a la modalidad de película	Abra el monitor LCD	Abra el monitor LCD
Abra el monitor LCD	Abra el monitor LCD	Pulse el botón de selección de opciones a la modalidad de cámara estática	Pulse el botón de selección de opciones a la modalidad de película
Ajuste el control de enfoque	Pulse el botón del disparador para comenzar la grabación	Pulse el botón de visualización	Pulse el botón de visualización
Pulse el botón del disparador	Pulse de nuevo el botón del disparador para detener la grabación	Use el panel de operaciones para seleccionar la imagen	Use el panel de operaciones para seleccionar la película
Capte la imagen	(Puede grabar hasta 30 segundos de un clip de película. Si supera los 30 segundos, el binocular mantendrá los últimos 30 segundos)	Pulse el botón de entrar (modalidad de función de visualización)	Pulse el botón de entrar (modalidad de función de visualización)
		1. Thumbnail (Imagen en miniatura) 2. Aumentar 3. Gestionar 4. Fijar 5. Salir	1. Thumbnail (Imagen en miniatura) 2. Gestionar 3. Fijar 4. Salir

Encendido en posición On (Adaptador de CA/Pilas AA)

Exportación de imágenes/películas
Abra la cubierta terminal
Use el cable USB para conectar
(En esta modalidad, el binocular se convierte en un disco duro externo. Edite la película y la imagen directamente)
Salir



GUÍA DE FUNCIONAMIENTO - Captación de la imagen

Procedimiento de operación	Descripción de la foto	Acción del binocular
1. Pulse el botón de encendido		Use el botón de encendido para encender y apagar el binocular. LCD se apagará automáticamente para conservar energía si se deja inactivo (sin operar botones o interruptores) durante 2 minutos. Si se deja inactiva durante 5 minutos, la cámara se apagará para conservar energía.
2. Ponga la modalidad de captación de selección de opciones. Cambie a la modalidad de cámara estática.		Ahora puede captar imágenes en la modalidad de captación. Este procedimiento selecciona la grabación/reproducción de imágenes estáticas
3. Abra el monitor LCD		Componga imágenes usando la pantalla del monitor o los oculares del binocular. El enfoque se debe hacer siempre mientras se mira por el monitor LCD
4. Ajuste el control de enfoque central para lograr que la imagen del sujeto aparezca nítida en el monitor LCD		Gire el control de ajuste del enfoque hasta que la imagen aparezca nítida en el monitor.

Procedimiento de operación	Descripción de la foto	Acción del binocular
5. Pulse el botón del disparador para sacar la foto		La imagen grabada permanece en el monitor durante un segundo aproximadamente, luego vuelve a la modalidad original.

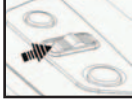
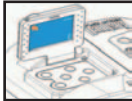

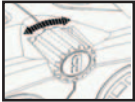



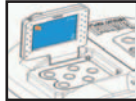

GUÍA DE FUNCIONAMIENTO - Captación de películas

Procedimiento de operación	Descripción de la foto	Acción del binocular
1. Pulse el botón de encendido		Use el botón de encendido para apagar y encender el binocular. LCD se apagará automáticamente para conservar energía si se deja inactivo (sin operar botones o interruptores) durante 2 minutos. Si se deja inactiva durante 5 minutos, la cámara se apagará para conservar energía.
2. Mueva el interruptor de selección de opciones a la modalidad de película		Ahora puede grabar películas en la Modalidad de película. Este procedimiento selecciona la grabación/reproducción de película.
3. Abra el monitor LCD		Componga imágenes usando la pantalla del monitor o el ocular del binocular. El enfoque debe hacerse siempre mientras se mira por el monitor LCD.

Procedimiento de operación	Descripción de la foto	Acción del binocular
4. Ajuste el control de enfoque central para lograr que el sujeto aparezca con nitidez en el monitor LCD.		Gire el control de ajuste del enfoque hasta que la imagen aparezca nítida en la pantalla del monitor.
5. Pulse el botón del disparador		Comience a grabar películas.
6. Pulse de nuevo el botón del disparador.		Termine de grabar la película. (La duración máxima de la película es de 30 segundos. El Instant Replay seguirá grabando sobre la película anterior hasta que se pulse el botón del disparador segunda vez para detener la grabación. Por consiguiente, la memoria interna contendrá siempre los 30 segundos más recientes de la acción que se esté grabando.)

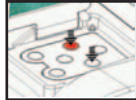
GUÍA DE FUNCIONAMIENTO - Reproducción de imágenes grabadas

Procedimiento de operación	Descripción de la foto	Acción del binocular
1. Pulse el botón de encendido		Use el botón de encendido para encender y apagar el binocular. LCD se apagará automáticamente para conservar energía si se deja inactivo (sin operar botones o interruptores) durante 2 minutos. Si se deja inactiva durante 5 minutos, la cámara se apagará para conservar energía.

Procedimiento de operación	Descripción de la foto	Acción del binocular
2. Ponga el interruptor de selección de opciones en la modalidad de cámara estática		Selecciona grabación/reproducción de imágenes
3. Abra el monitor LCD		Vea las imágenes en la pantalla del monitor.
4. Pulse el botón de visualización (display)		la imagen grabada se visualiza en el monitor
5. Use los   botones de “Flecha arriba” o “Flecha abajo” del panel de operaciones para seleccionar la imagen que quiere reproducir		Visualiza la imagen previa o siguiente almacenada en el binocular.
6. Pulse el botón de entrar para ver funciones de reproducción adicionales		Los artículos de la función Reproducir aparecen a la derecha de la pantalla
7. Use los   botones de “Flecha arriba” o “Flecha abajo” del panel de operaciones para seleccionar la función deseada		Seleccione la función en la pantalla.

Procedimiento de operación**Descripción de la foto****Acción del binocular**

8. Pulse el botón de entrar

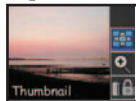

Los artículos de la función de Visualización (Display) aparecen a la derecha de la pantalla.

GUÍA DE FUNCIONAMIENTO - Funciones**Procedimiento de operación****Descripción de la foto****Acción del binocular****Función "Thumbnail"**
[Imagen en miniatura]

Muestra 9 imágenes en el monitor al mismo tiempo.

1. Use los botones del panel de operaciones para seleccionar una imagen específica.



La imagen seleccionada actualmente se enmarcará (realzará).

2. Pulse el botón de entrar



El archivo de imagen específico se visualiza en la pantalla del monitor.

3. Pulse el botón de entrar



Restablece la modalidad de reproducción de imágenes

Procedimiento de operación**Descripción de la foto****Acción del binocular****Función de aumento**

1. Pulse el botón de entrar



Visualiza la imagen actual ampliada.

2. Use los botones del panel para mover el área de visualización vertical u horizontalmente



"Flecha arriba": La imagen se mueve hacia arriba
"Flecha abajo": La imagen se mueve hacia abajo
"Flecha izquierda": La imagen se mueve a la izquierda
"Flecha derecha": La imagen se mueve a la derecha

3. Pulse el botón de entrar



Restablece la modalidad de reproducción de imágenes

Procedimiento de operación

Descripción de la foto

Acción del binocular

Función de Borrar y Fijar



1. Use los botones del panel de operaciones para seleccionar la opción del archivo de gestión

2. Pulse el botón de entrar

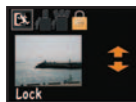
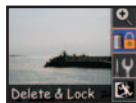

Visualiza la pantalla del archivo de gestión

Use los botones de “Flecha arriba” y “Flecha abajo” para seleccionar las imágenes. Use los botones de “Flecha izquierda” y “Flecha derecha” para seleccionar la opción [Salir – Borrar – Fijar].

Vuelve a la modalidad de reproducción de imágenes

Función de Configurar



1. Pulse el botón de visualización

2. Pulse el botón de entrar

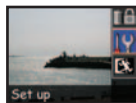
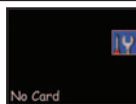

No se puede entrar la función Configurar si no se inserta una tarjeta de memoria.

Visualiza la pantalla de configuración

Si tiene insertada una tarjeta de memoria, pulse el botón de entrar, luego use los botones de flechas de dirección para seleccionar las configuraciones

Procedimiento de operación

Descripción de la foto

Acción del binocular

Función de Configurar Hora y Fecha

1. Use los botones del panel de operaciones para fijar la Hora y Fecha

2. Pulse el botón de entrar

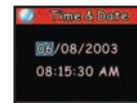

Formato CF

1. Use los botones del panel de operaciones para seleccionar Sí o No.

2. Pulse el botón de entrar

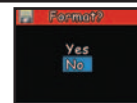

La configuración de Hora y Fecha aparece en la pantalla en la posición que está realizada.

Use los botones de “Flecha izquierda” y “Flecha derecha” para seleccionar la posición que aparece realizada y use los botones de “Flecha arriba” y “Flecha abajo” para cambiar el número.

Regresa a la modalidad de reproducción de imagen estática

La configuración de “Formato CF” aparece en la pantalla. Fije los artículos en la posición realizada.

Sí – Formatear Tarjeta CF
No – Cancelar formato



Regresa a la modalidad de reproducción de imágenes

Procedimiento de operación

Descripción de la foto

Acción del binocular

Salida de Vídeo

1. Use los   botones de “Flecha arriba” y “Flecha abajo” del panel de operaciones para seleccionar la configuración de salida de vídeo
2. Pulse el botón de entrar





La configuración de salida de vídeo aparece en la pantalla. La opción predeterminada es NTSC (norma de vídeo de EE.UU./Japón)

Elija PAL si se aplica a su país (la mayoría de los países europeos y asiáticos)

Regrese a la modalidad de reproducción de imagen.

Resolución

1. Use los   botones de “Flecha arriba” y “Flecha abajo” del panel de operaciones para seleccionar la configuración de resolución.
2. Pulse el botón de entrar



La configuración de resolución aparece en pantalla. La opción predeterminada es 1600x1200.

La configuración de resolución aparece en pantalla. La configuración presente es 800x600.



Vuelva a la modalidad de reproducción de imagen

Procedimiento de operación

Descripción de la foto

Acción del binocular

Sonido

1. Use los   botones de “Flecha arriba” y “Flecha abajo” del panel de operaciones para seleccionar la configuración de resolución.
2. Pulse el botón de entrar





La configuración principal de sonido se muestra en la pantalla. Es la opción predeterminada.

Aparece en la pantalla la configuración principal de sonido. La configuración presente está desconectada.

Regresa a la modalidad de reproducción de imágenes

Brillo del panel

1. Use los   botones de “Flecha arriba” y “Flecha abajo” del panel de operaciones para seleccionar la configuración de resolución.
2. Pulse el botón de entrar



La configuración de brillo del panel se muestra en pantalla. El brillo presente se identifica mediante la punta de flecha.

El brillo del panel se controla mediante la punta de flecha.

Vuelva a la modalidad de reproducción de imágenes

Restablecer la modalidad de captación

Salir

GUÍA DE FUNCIONAMIENTO - Reproducción de películas grabadas

Procedimiento de operación

Descripción de la foto

Acción del binocular

1. Pulse el botón de encendido



Use el botón de encendido para encender y apagar el binocular. LCD se apagará automáticamente para conservar energía si se deja inactivo (sin operar botones e interruptores) durante 2 minutos. Si se deja inactiva durante 5 minutos, la cámara se apagará para conservar energía.

2. Ponga la modalidad de película del interruptor de selección de opciones en la modalidad de película



Selecciona grabación/reproducción de película

3. Abra el monitor LCD

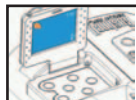

Ver la película en la pantalla del monitor.

4. Pulse el botón de visualización (Display)



la película grabada se visualiza en el monitor

Procedimiento de operación

Descripción de la foto

Acción del binocular

5. Use el botón "Flecha derecha" del panel de operaciones para poner la película



La pantalla del monitor está funcionando. Cuando se termine la película regresará a la última escena.

6. Pulse el botón Entrar

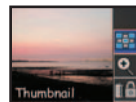

Los artículos de la función de visualización (Display) aparecen a la derecha de la pantalla

GUÍA DE FUNCIONAMIENTO - Funciones

Función Thumbnail

[Imagen en miniatura]



1. Use los botones del panel de operaciones para seleccionar la película.



Visualiza 9 películas en el monitor al mismo tiempo.

2. Pulse el botón de entrar



La película seleccionada actualmente será encuadrada (realzada).



La película grabada se visualiza en la pantalla del monitor.

Procedimiento de operación**Descripción de la foto****Acción del binocular**

3. Use el  botón “Flecha derecha” del panel de operaciones para poner la película.



En el monitor se visualiza “Cargando la película” durante 1 segundo aproximadamente y luego se pone la película

4. Use los   botones de “Flecha arriba” y “Flecha abajo” para seleccionar la película



la película grabada se visualiza en el monitor

5. Use el  botón “Flecha derecha” del panel de operaciones para poner la película



en el monitor se visualiza “Cargando la película” durante 1 segundo aproximadamente y luego se pone la película

6. Pulse el botón de entrar





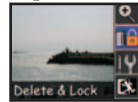

Regresa a la modalidad de reproducción de película

Procedimiento de operación**Descripción de la foto****Acción del binocular****Función de Borrar y Fijar**

1. Use los botones del panel de operaciones para seleccionar la opción de gestión de archivos



Use los   botones de “Flecha arriba” y “Flecha abajo” para seleccionar la película. Use los   botones de “Flecha izquierda” y “Flecha derecha” para seleccionar la opción [Salir – Borrar – Fijar]

2. Pulse el botón de entrar



Regresa a la modalidad de reproducción de película

**Función de Configurar**

1. Pulse el botón de visualización

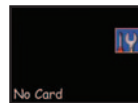

No se puede entrar la función de Configurar si no hay ninguna tarjeta de memoria insertada

2. Pulse el botón de entrar

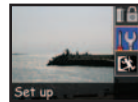

Visualizar la pantalla de configuración



Si tiene insertada una tarjeta de memoria, pulse el botón de entrar, luego use los botones de flechas de dirección para seleccionar las configuraciones

Procedimiento de operación

Descripción de la foto

Acción del binocular

Hora y Fecha

1. Use los botones del panel de operaciones para fijar la Hora y Fecha

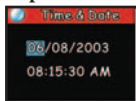

La configuración de Hora y Fecha se muestran en la pantalla. Cambie el número en la posición realizada.

Use los botones de “Flecha izquierda” y “Flecha derecha” para seleccionar la posición realizada y use los botones de “Flecha arriba” “Flecha abajo” para cambiar el número.

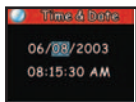

2. Pulse el botón de entrar



Regrese a la modalidad de reproducción de película

Formato CF

1. Use los botones del panel de operaciones para seleccionar Sí o No.



La configuración de “Formato CF” se muestra en la pantalla. Fije los artículos en la posición realizada.

Sí – Formatear la tarjeta CF
No – Cancelar el formato

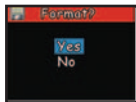

2. Pulse el botón de entrar



Regresa a la modalidad de reproducción de película

Procedimiento de operación

Descripción de la foto

Acción del binocular

Salida de Vídeo

1. Use los botones de “Flecha arriba” y “Flecha abajo” del panel de operaciones para seleccionar la configuración de salida de Vídeo



La configuración de salida de Vídeo se muestra en pantalla. La opción predeterminada es NTSC (normas de vídeo de EE.UU./Japón)

Elige PAL si se aplica a su país (la mayoría de los países europeos y asiáticos)

2. Pulse el botón de entrar



Regrese a la modalidad de reproducción de película.

Resolución

1. Use los botones de “Flecha arriba” y “Flecha abajo” del panel de operaciones para seleccionar la configuración de resolución.



La configuración de resolución se muestra en la pantalla. La opción predeterminada es 1600x1200.

La configuración de resolución aparece en la pantalla. La configuración actual es 800x600.

2. Pulse el botón de entrar



Regrese a la modalidad de reproducción de película



Procedimiento de operación

Descripción de la foto

Acción del binocular

Sonido

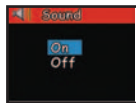

La configuración de sonido principal se muestra en la pantalla. La opción predeterminada está conectada.

1. Use los   botones de “Flecha arriba” y “Flecha abajo” del panel de operaciones para seleccionar la configuración de sonido.

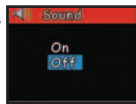

La configuración de sonido aparece en la pantalla. La configuración actual está desconectada.

2. Pulse el botón de entrar



Regrese a la modalidad de reproducción de película

Procedimiento de operación



Descripción de la foto

Acción del binocular

Brillo del panel



La configuración del brillo del panel se muestra en la pantalla. El brillo actual se identifica mediante la punta de flecha.

1. Use los   botones de “Flecha arriba” y “Flecha abajo” del panel de operaciones para seleccionar la configuración de resolución.



El brillo del panel se controla mediante la punta de flecha.

2. Pulse el botón de entrar



Regrese a la modalidad de reproducción de película

Salir



Restablecer la modalidad de captación de película

GUÍA DE FUNCIONAMIENTO - Reproducción en la T.V.

Procedimiento de operación

Descripción de la foto

Acción del binocular

1. Conexión. Conéctese a la T.V.
Make sure that the power of TV



2. Abra la cubierta de terminales del dispositivo y conecte el cable de vídeo al puerto AV de salida (out).



3. Conecte el otro extremo del cable de vídeo al puerto de entrada (in) de la T.V.



4. Conectar al adaptador de CA (o la pila)



5. Pulse el botón de encendido



6. Pulse el botón de encendido de la T.V.



Asegúrese de desconectar el botón de encendido de la T.V. y de la cámara

Mientras reproduce imágenes en la T.V., el adaptador de CA se puede conectar a cualquier enchufe de corriente de la casa para alimentar el dispositivo.

Procedimiento de operación

Descripción de la foto

Acción del binocular

Desconectar

1. Asegúrese de apagar la cámara
2. Quite el cable de vídeo



GUÍA DE FUNCIONAMIENTO - Estado de pila bajo

1. Pulse el botón de encendido





2. Si la capacidad de las pilas es baja, empezará a destellar el símbolo de la pila en la pantalla, se oirá un pitido de advertencia y destellará la luz LED



3. Si las pilas están gastadas, aparecerá en la pantalla el símbolo de la pila y el dispositivo emitirá un pitido de advertencia. Recargue la pila inmediatamente



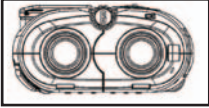

GUÍA DE FUNCIONAMIENTO - Ajuste de IPD (Ajuste del Espaciamento Ocular)

Procedimiento de operación	Descripción de la foto	Acción del binocular
<p>Cómo se ajusta la distancia entre los ojos – La distancia entre los ojos, denominada Distancia Interpupilar (IPD, en inglés), varía de una persona a otra. Para lograr un alineamiento perfecto de la lente a los ojos, siga estos sencillos pasos:</p> <ol style="list-style-type: none"> 1. Sujete su binocular en la posición de observación normal. 		Ajuste la distancia entre los ojos de acuerdo con la distancia interpupilar del usuario
<ol style="list-style-type: none"> 2. Agarre el binocular con firmeza y muévalo horizontalmente hasta que vea un campo circular único. 		El binocular dispone de unas ojeras diseñadas para ofrecer un mayor confort y excluir la luz superflua.

SE DEBE REPOSICIONAR SIEMPRE EN ESTA POSICIÓN ANTES DE USARLO.

GUÍA DE FUNCIONAMIENTO - Ajuste dióptrico (Enfoque)

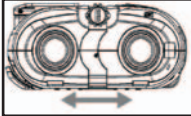
Cómo se debe ajustar de acuerdo con la agudeza visual ocular individual
 Cómo se debe ajustar de acuerdo con la agudeza visual ocular individual
 Cómo se debe ajustar de acuerdo con la agudeza visual ocular individual
 Cómo se debe ajustar de acuerdo con la agudeza visual ocular individual
 Cómo se debe ajustar de acuerdo con la agudeza visual ocular individual
 Cómo se debe ajustar de acuerdo con la agudeza visual ocular individual
 Cómo se debe ajustar de acuerdo con la agudeza visual ocular individual



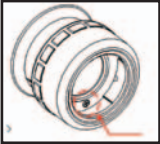
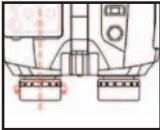
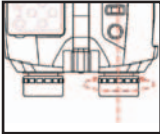

Procedimiento de operación	Descripción de la foto	Acción del binocular
a. Pulse el botón de encendido		Use el botón de encendido para encender y apagar el binocular. El binocular se apagará automáticamente para conservar energía si se deja inactivo (sin operar botones o interruptores) durante 2 minutos.
b. Ajuste la distancia interpupilar		Ajuste la distancia entre los ojos de acuerdo con la distancia interpupilar del usuario.
c. Abra el monitor LCD		Componga imágenes usando la pantalla del monitor o los oculares del binocular
d. Mueva el control de ajuste del enfoque para lograr una imagen nítida		Gire el control de ajuste hasta que la imagen de la pantalla del monitor sea nítida.
e. Mire por el binocular al mismo objeto en el que está enfocada la cámara. Si el objeto aparece nítido para el ojo izquierdo, proceda con el paso Mire por el binocular al mismo objeto en el que está enfocada la cámara. Si el objeto aparece nítido para el ojo izquierdo, proceda con el paso		

Procedimiento de operación	Descripción de la foto	Acción del binocular
f. Afloje el tornillo de fijación con un destornillador		Deje que su vista se ajuste ligeramente (primero el ojo izquierdo)
g. Ajuste ligeramente el ojo izquierdo.		Ajuste el control dióptrico para lograr el enfoque más nítido
h. Ajuste ligeramente el ojo izquierdo.		Ajuste hasta lograr el enfoque más nítido. Si los dos tubos del binocular están bien sincronizados entre sí y con la cámara, sólo tiene que girar el mando de enfoque central para ajustar el enfoque de los tres.

Después de ajustarlo, podrá ver los objetos con nitidez. Los diferentes usuarios pueden ajustarlo según sus necesidades. El binocular está ahora configurado para su vista individual. Los ajustes del ocular no afectarán el enfoque de la cámara.



Instrucciones de conexión a un PC (Instalación del CD)



Si su ordenador tiene un sistema Windows ME, Win2000 o Win XP, puede saltarse este proceso (el controlador sólo es necesario para Windows 98)

Procedimiento de operación	Descripción de la foto	Acción del binocular
1. Encienda su ordenador.		El monitor de su ordenador mostrará "Install image".
2. Ponga el CD en la unidad CD-Rom y el sistema se ejecutará automáticamente.		El monitor del ordenador mostrará una imagen de bienvenida.
3. Seleccione "Install Driver" (Instalar controlador) para instalar el software. Des esta forma se instalará el controlador en el ordenador.		
4. Seleccione "Next" (Siguiente) para continuar.		
5. Seleccione el artículo que quiere instalar y haga clic en el icono "Install" (Instalar) en el monitor del ordenador.		
6. Seleccione el artículo para completar el proceso. Salga de la instalación de imagen. Haga clic en el icono Finish (Terminar).		

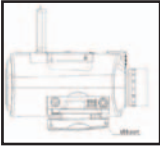
TENDRÁ QUE REINICIAR SU ORDENADOR DESPUÉS DE TERMINAR LA INSTALACIÓN Y ANTES DE CONECTAR LA CÁMARA Y EL CABLE USB.

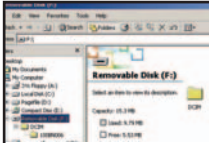
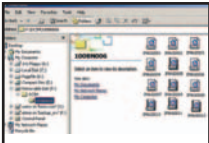
GUÍA DE FUNCIONAMIENTO - Transferencia de imágenes

Procedimiento de operación	Descripción de la foto	Acción del binocular
a. Conecte el cable USB con seguridad desde el puerto USB del Instant Replay hasta el ordenador.		La ventana del PC mostrará “Se ha encontrado un nuevo disco duro”- En esta modalidad el binocular se convierte en el disco duro externo – Edite directamente las películas e imágenes
b. Pulse el botón de encendido del Instant Replay.		
c. El Instant Replay será reconocido como un dispositivo nuevo de almacenamiento (USB) que no difiere esencialmente de una unidad de disco duro externa y que contiene los archivos de las imágenes estáticas y de las películas. Usando Windows Explorer o “My Computer” (Mi ordenador), puede ver el contenido de la tarjeta / memoria interna del Instant Replay CF haciendo clic en cualquiera de los archivos para ver las imágenes y las películas. Los puede guardar individualmente en su unidad interna de disco duro después de abrirlos y verlos en Microsoft Photo Editor o cualquier otro programa de gráficos. También puede seleccionar algunos, o todos, los archivos que hay en el Instant Replay en Explorer y arrastrarlos o copiarlos / pegarlos en una carpeta de su unidad de disco duro, igual que haría con cualquier otro archivo.	 	

Procedimiento de operación	Descripción de la foto	Acción del binocular
3. Transferir las películas e imágenes al ordenador		El monitor muestra que está transfiriendo los archivos a la carpeta seleccionada
4. Salir	  	

Recoger el icono de la bandeja de tareas de la pantalla del ordenador y seleccionar la opción Salir para desconectar el cable USB.

GARANTÍA LIMITADA DE DOS AÑOS

Su producto Bushnell® está garantizado contra defectos de material y fabricación durante dos años a partir de la fecha de compra. En caso de defectos bajo esta garantía, nosotros, a nuestra opción, repararemos o sustituiremos el producto siempre que lo devuelva con portes pagados. Esta garantía no cubre defectos causados por el uso indebido, ni por un manejo, instalación o mantenimiento del producto inapropiados o el mantenimiento hecho por otro que no sea un Centro de Servicio Autorizado de Bushnell.

Cualquier envío que se haga bajo garantía deberá venir acompañado por lo siguiente:

- 1) Un cheque/giro postal por la cantidad de 10 dólares para cubrir los gastos de manejo y envío
- 2) Nombre y dirección donde quiere que se le envíe el producto
- 3) Una explicación del defecto
- 4) Prueba de fecha de compra
- 5) El producto debe empaquetarse bien en una caja resistente para evitar que se dañe durante el transporte, y enviarse con portes pagados a la dirección que se muestra a continuación:

EN EE UU, ENVIAR A:

Bushnell Performance Optics
Attn.: Repairs
8500 Marshall Drive
Lenexa, Kansas 66214

EN CANADÁ, ENVIAR A:

Bushnell Performance Optics
Attn.: Repairs
25A East Pearce Street, Unit 1
Richmond Hill, Ontario L4B 2M9

En el caso de los productos comprados fuera de los Estados Unidos o Canadá, llame al distribuidor local para la información pertinente sobre la garantía. En Europa también puede llamar al:

BUSHNELL Performance
Optics GmbH
European Service Centre
MORSESTRASSE 4
D- 50769 KÖLN
ALEMANIA
Tél: +49 (0) 221 709 939 3
Fax: +49 (0) 221 709 939 8

Esta garantía le ofrece derechos legales específicos.
Puede que tenga otros derechos que varían de un país a otro.
©2004 Bushnell Performance Optics

Bushnell®

DEUTSCH



18-0832

LIT. #: 98-0377/01-04

Bedienungsanleitung

Herzlichen Glückwunsch zum Erwerb Ihres neuen Bushnell-Fernglases. Es ist ein Präzisionsinstrument, das Ihnen viele Jahre Freude bereiten soll. Diese Gebrauchsanweisung wird Ihnen helfen, das Gerät optimal zu nutzen. Dazu erfahren Sie nachfolgend, wie Sie das Fernglas optimal auf Ihre Augen einstellen und wie das Gerät zu pflegen ist. Lesen Sie diese Anleitung vor Gebrauch des Fernglases bitte genau durch.



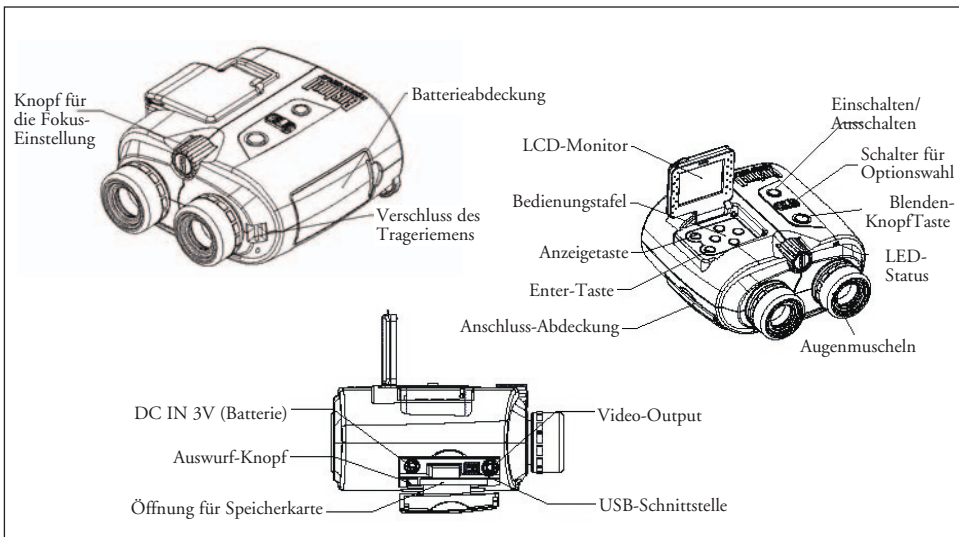

BEDIENELEMENTE UND BEZEICHNUNGEN



INBETRIEBNAHME

Einschalten				Power OnEinschalten (AC- Adapter oder /AA Batterie)
Aufnahme Fotografieren	Aufnahmen von Filmsequenzen	Anzeigen (Standbild-Modus)	Abspielen Film-Modus	Bild/Film Export
Schalter für Optionswahl auf „Still Camera Mode“ (Standbild Modus) stellen	Schalter für Optionswahl auf „Movie Mode“ (Film-Modus) stellen	Öffnen des LCD AnzeigeMonitors	Öffnen des LCD-AnzeigeMonitors	Öffnen der Terminal-Abdeckung Anschluss-Abdeckung
Öffnen des LCD-Anzeige Monitors	Öffnen des LCD AnzeigeMonitors	Schalter für Optionswahl auf Standbild-Modus stellen	Schalter für Optionswahl auf Film-Modus stellen	Mit USB-Kabel anschließen
Schärfe einstellen	Drücken des der Blenden KnopfsTaste, um die Aufnahme zu starten	Drücken des der AnzeigeknopfsAnze gentaste	Drücken des der AnzeigeknopfsAnze gentaste	In diesem Modus ist verhält sich die Kamera wie eine externe Festplatte. Bild und Film werden direkt bearbeitet
Bildaufnahme	Erneutes Drücken des der Blenden KnopfsTaste, um die Aufnahme zu beenden	Wählen Sie auf dem Bedienungspanel edienungsfeld das Bild	Wählen Sie auf dem Bedienungspanel edienungsfeld „Film“	Verlassen
	Sie können Filmsequenzen von bis zu 30 Sekunden aufnehmen. Wenn die Sequenz länger ist, speichert das Fernglas die letzten 30 Sekunden	Enter-Knopf drücken (Anzeige Funktionsmodus)	Enter-Knopf drücken (Anzeige Funktionsmodus)	
		1. Daumennagel Miniaturbild 2. Vergrößern 3. Verwalten 4. Konfigurieren 5. Verlassen	1. Miniaturbild 2. Daumennagel 3. Verwalten 4. Konfigurieren 5. Verlassen	

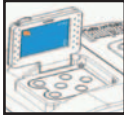
GEBRAUCHSANWEISUNG - Aufnahmen von Bildern

Vorgehensweise	Bildbeschreibung	Wirkung
1. Drücken der Power-Taste		Mit der Power-Taste wird das Fernglas ein- und ausgeschaltet. LCD schaltet sich automatisch aus, um Energie zu sparen, wenn es 2 Min. lang nicht verwendet wird (d.h. wenn keine Knöpfe oder Schalter betätigt werden). Wenn die Kamera 5 Minuten lang nicht arbeitet, schaltet die Hauptstromversorgung ab, um Energie zu sparen.
2. Drücken des Schalters für Optionswahl, um vom Anzeige-Modus in den Standbild-Modus zu gelangen.		Nun können Sie im Aufnahme-Modus Bilder machen. [..]
3. Öffnen des LCD-Monitors entweder		Betrachten Sie Ihre Objekte über den Bildschirm oder die Okulare der Ferngläser. Bei der SchärfEinstellung sollten Sie immer den LCD-Monitor im Blick haben.
4. Mitteltrieb einstellen, damit der aufgenommene Gegenstand scharf auf dem LCD-Monitor erscheint		Drehregler für die SchärfEinstellung drehen, bis das Bild auf dem Bildschirm scharf ist.

Vorgehensweise

5. Drücken der Blenden-Taste, um eine Aufnahme zu machen

Bildbeschreibung



Wirkung

Das aufgenommene Bild verbleibt ca. eine Sekunde auf dem Bildschirm, dann wird der Ausgangsmodus wieder hergestellt.

GEBRAUCHSANWEISUNG - Aufnahmen von Filmsequenzen

Vorgehensweise

1. Drücken desr Power-Taste

Bildbeschreibung



WirkungAn der Fernglaskamera

Mit demr Power-Taste wird das Fernglas ein- und ausgeschaltet. LCD schaltet sich automatisch aus, um Energie zu sparen, wenn es 2 Min. lang nicht verwendet wird (d.h. wenn keine Tasten oder Schalter betätigt werden). Wenn die Kamera 5 Minuten lang nicht arbeitet, schaltet die Hauptstromversorgung ab, um Energie zu sparen.

2. Den Schalter für Optionswahl auf Film-Modus stellen.





Nun können Sie im Film-Modus Filmsequenzen aufnehmen. [..]

3. Öffnen desr LCD-Monitors



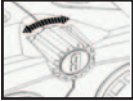







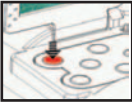

Betrachten Sie Ihre Objekte entweder über den Bildschirm oder die Okulare der Ferngläser. Bei der SchärfEinstellung sollten Sie immer den LCD-Monitor im Blick haben.

Vorgehensweise	Bildbeschreibung	Wirkung
4. Mitteltrieb einstellen, damit der aufgenommene Gegenstand klar auf dem LCD-Monitor erscheint.		Drehregler für die Schärfereinstellung drehen, bis das Bild auf dem Bildschirm scharf ist.
5. Drücken der Blenden-Taste		Beginn der Filmaufnahme.
6. Erneutes Drücken des der Blenden-Taste.		Erneutes Drücken der Blenden-Taste. Bildbeschreibung – Bild einfügen Wirkung – Ende der Filmaufnahme. (Höchstlänge der Filmsequenzen: 30 Sekunden). Das Instant Replay überspielt die Aufnahme solange, bis die Blenden-Taste zum Beenden der Aufnahme ein zweites Mal gedrückt wird. (Daher sind immer die letzten 30 Sekunden gespeichert.)

GEBRAUCHSANWEISUNG - Anzeigen von aufgenommenen Bildern

Vorgehensweise	Bildbeschreibung	Wirkung
1. Drücken desr Power-Taste		Mit der Power-Taste wird das Fernglas ein- und ausgeschaltet. LCD schaltet sich automatisch aus, um Energie zu sparen, wenn es 2 Min. lang nicht verwendet wird (d.h. wenn keine Tasten oder Schalter betätigt werden). Wenn die Kamera 5 Minuten lang nicht arbeitet, schaltet die Hauptstromversorgung ab, um Energie zu sparen.

Vorgehensweise	Bildbeschreibung	Wirkung
2. Drücken des Schalters für Optionswahl, um vom Anzeige-Modus in den Standbild-Modus zu gelangen.		Auswahl von Standbild-Aufnahme/anzeigen
3. Öffnen desr LCD-AnzeigeMonitors		Bilder auf dem Bildschirm anzeigen.
4. Anzeigetaste drücken		das aufgenommene Bild wird auf dem Bildschirm angezeigt
5. Mit den   Pfeilen auf dem BedienungspanelBedienungsfeld wählen Sie das Bild, das angezeigt werden soll		Anzeige des vorhergehenden oder nachfolgenden im Fernglas gespeicherten Fotos.
6. Drücken der Enter-Taste für zusätzliche Anzeige-Funktionen		Anzeige-Funktionen erscheinen rechts am im Bildschirm
7. Mit den   Pfeilen auf dem Bedienungs-feld wählen Sie die gewünschte Funktion		Gewünschte Funktion auf dem Bildschirm wird ausgewählt.

Vorgehensweise

8. Enter-Taste drücken

Bildbeschreibung

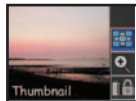

Wirkung

Anzeige-Funktionen erscheinen rechts am im Bildschirm.

GEBRAUCHSANWEISUNG - Funktionen

Daumennagel Miniaturbild-Funktion



1. Mit den Tasten auf dem Bedienungsfeld wählen Sie ein bestimmtes Bild.



2. Enter-Taste drücken



3. Enter-Taste drücken



9 Fotos werden gleichzeitig auf dem Bildschirm angezeigt.

Das gewählte Bild wird umrahmt (hervorgehoben).

Diese Bilddatei wird auf dem Bildschirm angezeigt.

Bild-Anzeige-Modus wieder herstellen

Vorgehensweise

Vergrößern Funktion



1. Enter-Taste drücken

Bildbeschreibung



2. Mit den Bedienungsfeld -Tasten bewegen Sie das Anzeigefeld vertikal und horizontal

3. Enter-Taste drücken



Wirkung

Das aufgenommene Bild wird angezeigt.

Vergößerte Anzeige des aktuellen Fotos.

“Pfeil aufwärts”: Bild bewegt sich nach oben
 “Pfeil abwärts”: Bild bewegt sich nach unten
 “Pfeil links”: Bild bewegt sich nach links
 “Pfeil rechts”: Bild bewegt sich nach rechts

Bild-Anzeige-Modus wieder herstellen

Vorgehensweise

Bildbeschreibung

Wirkung

Lösch- und Sperrfunktion



1. Mit den Tasten auf dem Bedienungsfeld wählen Sie die Option Dateiverwaltung



Anzeige des Bildschirms für Dateiverwaltung

2. Enter-Taste drücken

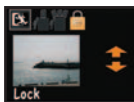

Verwenden Sie „Pfeil aufwärts“ und „Pfeil abwärts“ zum Auswählen der Bilder. Verwenden Sie „Pfeil links“ und „Pfeil rechts“ zum Auswählen der [Verlassen – Löschen – Sperren] Option

Zurück zu Bild-Anzeige-Modus



Konfigurations-Funktion



1. Drücken des der Anzeigentasteknopfs
2. Enter-Taste drücken



Die Konfigurations-Funktion ist nur verfügbar wenn keine Speicherkarte eingelegt ist



Anzeige des Bildschirms „Einstellungen“



Wenn eine Speicherkarte vorhanden ist, Enter-Taste drücken, anschließend wählen Sie mit den Pfeilen die gewünschte Einstellung

Vorgehensweise

Bildbeschreibung

Wirkung

Uhrzeit und Datum

1. Verwenden Sie die Tasten auf dem Bedienungsfeld zum Einstellen von Uhrzeit und Datum

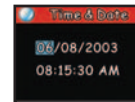

2. Enter-Taste drücken



Uhrzeit und Datum erscheinen auf dem Bildschirm. Verstellen Sie die neue Zahl der markierten Position.

Verwenden Sie „Pfeil links“ und „Pfeil rechts“ zum Wählen der markierten Position. Verwenden Sie „Pfeil aufwärts“ und „Pfeil abwärts“ zum Ändern der Zahl.

Zurück zu Standbild-Anzeige-Modus

Format CF

1. Verwenden Sie die Tasten auf dem Bedienungsfeld zur Auswahl „Ja“ oder „Nein“.



2. Enter-Knopf drücken







“Format CF” erscheint auf dem Bildschirm. Konfiguration an der markierten Position

Ja – Format CF- Karte wird gewählt
Nein – Format wird gelöscht





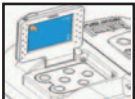

Zurück zu Bild-Anzeige-Modus





Vorgehensweise	Bildbeschreibung	Wirkung
Video-Ausgang Out		“Video Out“ erscheint auf dem Bildschirm. Voreinstellung: NTSC (US/Japan Video-Normen)
1. Wählen Sie mit   auf dem Bedienungsfeld die Einstellung für Video Out		Wählen Sie PAL wenn es den Normen Ihres Landes entspricht (dies ist in den meisten europäischen und asiatischen Staaten der Fall)
2. Enter-Taste drücken		Zurück zu Bild-Anzeige-Modus.

Vorgehensweise	Bildbeschreibung	Wirkung
Auflösung		Die Auflösung erscheint auf dem Bildschirm. Voreinstellung: 1600x1200.
1. Wählen Sie mit   auf dem BedienungspanelBedienungsfeld die Einstellung für die Auflösung.		Die eingestellte Auflösung erscheint auf dem Bildschirm. Voreinstellung: 800x600.
2. Enter-Taste drücken		Zurück zu Bild-Anzeige-Modus

Vorgehensweise	Bildbeschreibung	Wirkung
Ton		Die Tasten für die Ton-Einstellung erscheinen auf dem Bildschirm. Voreinstellung: ein.
1. Wählen Sie mit   auf dem Bedienungsfeld die Einstellung für den Ton.		Die Tasten für die Ton-Einstellung erscheinen Einstellung erscheint auf dem Bildschirm. Voreinstellung: offaus. Die momentane Einstellung ist deaktiviert.
2. Enter-Taste drücken		Zurück zu Bild-Anzeige Modus

Vorgehensweise	Bildbeschreibung	Wirkung
Helligkeit des PanelsBedienungsfeldes		Die Tasten zur Regulierung der Helligkeit des Bedienungsfeldes erscheint auf dem Bildschirm. Die aktuell eingestellte Helligkeit wird durch einen Pfeil angezeigt.
1. Wählen Sie mit   auf dem Bedienungsfeld die Einstellung für die Helligkeit.		Die Helligkeit des Panels Bedienungsfeldes wird durch den Pfeil gesteuert.
2. Enter-Taste drücken		Zurück zu Bild-Anzeige-Modus
Verlassen		Aufnahme-Modus wieder herstellen

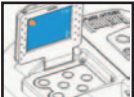
GEBRAUCHSANWEISUNG - Abspielen von aufgenommenen Filmsequenzen

Vorgehensweise	Bildbeschreibung	Wirkung
1. Drücken der Power-Taste		Mit dem der Power-Taste wird das Fernglas ein- und ausgeschaltet. LCD schaltet sich automatisch aus, um Energie zu sparen, wenn es 2 Min. lang nicht verwendet wird (d.h. wenn keine Tasten oder Schalter betätigt werden). Wenn die Kamera 5 Minuten lang nicht arbeitet, schaltet die Hauptstromversorgung ab, um Energie zu sparen.
2. Schalter für Optionswahl auf Film-Modus stellen		Auswahl von Film aufnehmen/abspielen
3. Öffnen des LCD-Monitors		Filmsequenz auf dem Bildschirm ansehen.
4. Anzeigentaste drücken		Die aufgenommene Filmsequenz wird auf dem Bildschirm angezeigt

Vorgehensweise	Bildbeschreibung	Wirkung
5. Verwenden Sie den „Pfeil rechts“ auf dem Bedienungsfeld, um den Film abzuspielen		Bildschirm spielt ab. Wenn die Sequenz abgeschlossen ist, kehrt er zur letzten Szene zurück.
6. Drücken der Enter-Taste		Anzeige-Funktionen erscheinen rechts auf dem Bildschirm

GEBRAUCHSANWEISUNG - Functions (Playback Recorded Movies)

Daumennagel Miniaturbild-Funktion



1. Mit den Tasten auf dem Bedienungsfeld wählen Sie einen bestimmten Film.



9 Filme werden gleichzeitig auf dem Bildschirm angezeigt.

2. Enter-Taste drücken



Die gewählte Sequenz wird umrahmt (hervorgehoben)



Die aufgenommene Filmsequenz wird auf dem Bildschirm abgespielt.

Vorgehensweise

3. Verwenden Sie  auf dem Bedienungsfeld, um den Film abzuspielen.

4. Verwenden Sie   zum Wählen des Films

5. Verwenden Sie  auf dem Bedienungsfeld, um den Film abzuspielen

6. Enter-Taste drücken

Bildbeschreibung



Wirkung

Der Bildschirm zeigt etwa 1 Sekunde lang „Loading Movie“ (Lädt den Film lädt“) an und spielt anschließend den Film ab.

Die aufgenommene Filmsequenz wird auf dem Bildschirm angezeigt

Der Bildschirm zeigt etwa 1 Sekunde lang „Film lädt“ an und spielt anschließend den Film ab

Zurück zu Film-Abspiel-Modus

Vorgehensweise

Lösch- und Sperrfunktion



1. Mit den Tasten auf dem Bedienungsfeld wählen Sie die Option Dateiverwaltung

2. Enter-Taste drücken

Konfigurations-Funktion



1. Drücken des der Anzeigentaste



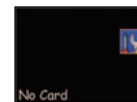

2. Enter-Taste drücken

Bildbeschreibung



Wirkung

Anzeige des Bildschirms für Dateiverwaltung



Verwenden Sie   zum Wählen des Films. Verwenden Sie   zur Auswahl [Verlassen – Löschen – Sperren] der Option



Zurück zu Film-Abspiel-Modus



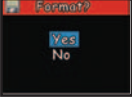

Die Konfigurations-Funktion ist nur verfügbar wenn keine Speicherkarte eingelegt ist

Anzeige des Bildschirms „Einstellungen“

Nur wenn eine Speicherkarte vorhanden ist, Enter-Taste drücken, anschließend wählen Sie mit den Pfeilen die gewünschte Einstellung.

Vorgehensweise	Bildbeschreibung	Wirkung
Uhrzeit und Datum		Uhrzeit und Datum erscheinen auf dem Bildschirm. Verstellen Sie die neue Zahl für die hervorgehobene Stelle einer markierten Position.
1. Verwenden Sie die Tasten auf dem Bedienungsfeld zum Einstellen von Uhrzeit und Datum		Verwenden Sie   zum Wählen der hervorgehobenen Stellenmarkierten Position. Verwenden Sie   zum Ändern der Zahl.
2. Enter-Knopf Taste drücken		Zurück zu Film-Abspiel-Modus

Vorgehensweise	Bildbeschreibung	Wirkung
Format CF		“Format CF” erscheint auf dem Bildschirm. Konfiguration an der hervorgehobenen Stelle.
1. Verwenden Sie die Tasten auf dem Bedienungsfeld zur Auswahl „Ja“ oder „Nein“.		Ja – Format CF-Karte wird gewählt Nein –Format wird gelöscht
2. Enter-Knopf Taste drücken		Zurück zu Film-Abspiel-Modus

Vorgehensweise	Bildbeschreibung	Wirkung
Video-Ausgang Out		“Video Out“ erscheint auf dem Bildschirm. Voreinstellung: NTSC (US/Japan Video-Normen)
1. Wählen Sie mit   auf dem Bedienungsfeld die Einstellung für den Video-Ausgang		Wählen Sie PAL wenn es den Normen Ihres Landes entspricht (dies ist in den meisten europäischen und asiatischen Staaten der Fall)
2. Enter-Taste drücken		Zurück zu Film-Abspiel-Modus.

Vorgehensweise	Bildbeschreibung	Wirkung
Auflösung		Die Auflösung erscheint auf dem Bildschirm. Voreinstellung: 1600x1200.
1. Wählen Sie mit   auf dem Bedienungsfeld die Einstellung für die Auflösung.		Die eingestellte Auflösung erscheint auf dem Bildschirm. Voreinstellung: 800x600.
2. Enter-Taste drücken		Zurück zu Film-Abspiel-Modus

Vorgehensweise

Bildbeschreibung

Wirkung

Ton



Die Tasten für die Ton-Einstellung erscheinen auf dem Bildschirm.
Voreinstellung: ein.

1. Wählen Sie mit   auf dem Bedienungsfeld die Einstellung für den Ton.



Die Tasten für die Ton-Einstellung erscheinen auf dem Bildschirm. Die momentane Einstellung ist deaktiviert.

2. Enter-Taste drücken



Zurück zu Film-Abspiel-Modus

Vorgehensweise

Bildbeschreibung

Wirkung

Helligkeit des Bedienungsfeldes



Die Helligkeitseinstellung des Bedienungsfeldes erscheint auf dem Bildschirm. Die aktuell eingestellte Helligkeit wird durch einen Pfeil angezeigt.

1. Wählen Sie mit   auf dem Bedienungsfeld die Einstellung für die Helligkeit aus.



Die Helligkeit des Panels Bedienungsfeldes wird durch den Pfeil gesteuert.

2. Enter-Taste drücken







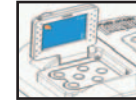

Zurück zu Film-Abspiel-Modus

Verlassen

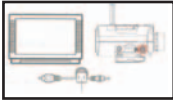



Aufnahme-Modus von Filmsequenzen wieder herstellen

GEBRAUCHSANWEISUNG - Playback im Fernseher

Vorgehensweise	Bildbeschreibung	Wirkung
1. Anschluß. Sich an den Fernseher anschließen.		Sichergehen, daß der Strom sowohl vom Fernseher als auch von der Kamera abgeschaltet ist.
2. Den Terminaldeckel der Vorrichtung öffnen und das Videokabel an den AV Ausgangsport anschließen.		
3. Das andere Ende des Videokabels an den Video-Eingangsport am Fernseher anschließen.		
4. An das AC (WS) Netzteil (oder an die Batterie) anschließen.		
5. Den An-Schalter drücken		Während des Abspielens von Bildern am Fernseher kann das WS-Netzteil für die Speisung des Geräts an jede beliebige Steckdose im Haushalt angeschlossen werden.
6. Den An-Schalter des Fernsehers drücken. Bildbeschreibung – Bild einsetzen		

Vorgehensweise	Bildbeschreibung	Wirkung
Betriebsverfahren		
1. Betriebsverfahren – Abtrennen: Sichergehen, daß die Kameraspeisung abgeschaltet ist.		
2. Das Videokabel entfernen		

GEBRAUCHSANWEISUNG - Schwache Batterieladung

1. Den An-Schalter drücken	
2. Bei schwacher Batterieladung blinkt das Batteriesymbol am Bildschirm, es erfolgt ein Warnton, und die LED blinkt.	
3. Bei leeren Batterien erscheint das Batteriesymbol am Bildschirm, und das Gerät sendet einen Warnton. Bitte die Batterien sofort wieder laden.	

GEBRAUCHSANWEISUNG - IPD Anpassung (Anpassung an Augenabstand)

Vorgehensweise

Bildbeschreibung

Wirkung

Wie passt man das Fernglas an seinen persönlichen Augenabstand an – Der Abstand zwischen Augen, der so genannte Pupillenabstand, ist bei jedem Menschen anders. In einigen einfachen Schritten richten Sie das Objektiv perfekt auf Ihre Augen aus.

1. Halten Sie das Fernglas so, wie Sie es bei der Anwendung gewohnt sind.

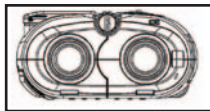

Stellen Sie den Augenabstand auf den jeweiligen Anwender ein

2. Halten Sie das Fernglas fest und verstellen Sie die Fernglas-Hälfte bis Sie ein einziges rundes Feld sehen.

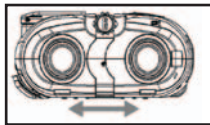

Das Fernglas ist mit Augenmuscheln ausgestattet, die sowohl für Komfort sorgen als auch vor Lichteinfall von Außen schützen.

GEBRAUCHSANWEISUNG - Dioptrien-Anpassung (Fokussieren)

Die Anpassung an die individuelle Sehschärfe – Da jede Person eine andere individuelle Sehschärfe hat, haben die meisten Ferngläser eine Dioptriereinstellung, damit Sie das Fernglas auf Ihre Sicht feineinstellen können. Die Kamera und das Fernglas sind so eingestellt, daß sie für die Sehschärfe von 20/20 oder korrigierter Sehschärfe passen. Es kann sein, daß Sie sowohl das linke als auch das rechte Auge passend auf die Kamera einstellen müssen, wie dies bei den meisten Ferngläsern der Fall ist. Befolgen Sie die untenstehenden Anweisungen für Ihren Ferngläsertyp.

Vorgehensweise

Bildbeschreibung

Wirkung

- a. Drücken der Power-Taste



Mit der Power-Taste wird das Fernglas ein- und ausgeschaltet. Das Fernglas schaltet sich automatisch aus um Energie zu sparen, wenn es 2 Min. lang nicht verwendet wird (d.h. wenn keine Tasten oder Schalter betätigt werden).

- b. Anpassen des Augenabstands

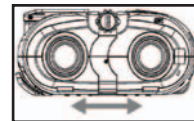

Stellen Sie Jje nach Augenabstand des Anwenders die Fernglashälften passend ein.

- c. Öffnen des LCD-Monitors



Wählen Sie Ihre Bilder entweder über den Bildschirm oder die Okulare der Ferngläser.

- d. Durch Drehen des wird das Bild scharf gestellt.

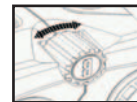

DrehreglerKnopf für die Fokus-ESchärfereinstellung drehen, bis das Bild auf dem Bildschirm scharf ist.



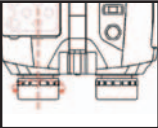
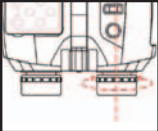

- e. Schauen Sie durch das Fernglas auf das gleiche Objekt, auf das die Kamera eingestellt ist. Wenn das Objekt für ihr linkes Auge scharf ist, führen Sie die Schritte g und dann h durch. Wenn das Objekt mit dem linken Auge nicht scharf ist, befolgen Sie die Schritte f und dann g und h.

Vorgehensweise	Bildbeschreibung	Wirkung
f. Drehen Öffnen der Schrauben mit Schraubenzieher		Lassen Sie dem Auge Zeit, sich an die Einstellung zu gewöhnen (zuerst linkes Auge)
g. Geringes Anpassen des linken Auges		Wählen Sie die Dioptrie-Anzahl, mit der der optimale Schärfe erreicht wird.
h. Geringes Anpassen des rechten Auges		Wählen Sie die Dioptrie-Anzahl, mit der die optimale Schärfe erreicht wird. Wenn beide Zylinder des Fernglases miteinander und mit der Kamera übereinstimmen, brauchen Sie nur den Fokusknopf in der Mitte zu drehen, um den Fokus für alle drei einzustellen.

Sobald die Anpassungen vorgenommen wurden, sehen Sie Gegenstände scharf. Andere Anwender können das Fernglas auf ihre jeweilige Sehstärke einstellen.

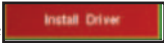

Das Fernglas ist nun auf Ihre persönliche Sehstärke eingestellt. Die Einstellungen an den Okularen des Fernglases haben keine Auswirkung auf die Kameraschärfe.

Anleitung für den PC-Anschluss (Installations-CD)



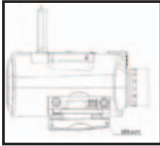

Vorgehensweise	Bildbeschreibung	Wirkung
Bei Betriebssystemen Windows ME, Win2000, oder Win XP ist dieser Vorgang nicht notwendig (dieser Arbeitsschritt ist nur bei Windows 98 nötig)		
1. Schalten Sie den Computer ein.		Auf dem Computerbildschirm erscheint das Installationsfenster.
2. Legen Sie die CD in das CD-ROM-Laufwerk ein, der Installationsvorgang startet von selbst.		Auf dem Computerbildschirm erscheint das Empfangsbild.
3. Wählen Sie "Install Drive", um die Software zu installieren. Nun wird die Driver-Einheit auf dem Computer installiert.		
4. Wählen Sie "Next" (Weiter).		
5. Wählen Sie das Element, das installiert werden soll und klicken Sie auf das „Install“-Symbol auf dem Computerbildschirm.		
6. Wählen Sie das Element, das beendet werden soll. Verlassen Sie das Installationsfenster. Klicken Sie auf das „Finish“-Symbol (Verlassen).		

NACH ABGESCHLOSSENER INSTALLATION UND BEVOR SIE DIE KAMERA UND DAS USB-KABEL ANSCHLIESSEN, MUSS DER COMPUTER NEU GESTARTET WERDEN.

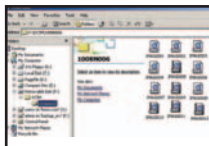
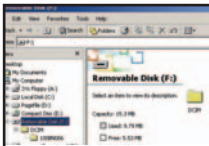
GEBRAUCHSANWEISUNG - Anleitung für den PC-Anschluss (USB-Anschluss)

Vorgehensweise	Bildbeschreibung	Wirkung
a. Verbinden Sie mit dem USB-Kabel das Instant Replay mit Ihrem Computer.		Auf Ihrem PC erscheint: „Neue Festplatte gefunden“- In diesem Modus wird das Fernglas zu einer externen Festplatte- Bearbeiten Sie die Filme und Bilder direkt am Computer
b. Drücken Sie die Power-Taste am Instant Replay.		
c. Das Instant Replay wird als neues (USB) Speichergerät erkannt, im Prinzip so wie eine externe Festplatte, auf der Ihre Standbilder und Filmsequenzen als Dateien gespeichert sind. Im Windows Explorer oder in „Mein Computer“ können Sie den Inhalt der Instant Replay CF-Karte/internen Speichers anzeigen, indem Sie die Dateien der Bilder und Filme anklicken. Sie haben die Möglichkeit, diese einzeln auf Ihrer Festplatte zu speichern, nachdem Sie sie mit Microsoft Photo Editor oder einem anderen Grafikprogramm geöffnet und angesehen haben. Sie haben auch die Möglichkeit, einige oder alle Instant Replay Dateien im Explorer auszuwählen und diese in ein Festplattenverzeichnis zu verschieben oder zu kopieren - genau so wie sie es mit anderen Dateien auch machen.		



Vorgehensweise	Bildbeschreibung	Wirkung
3. Übertragen der Filmsequenzen und Fotos auf den Computer		Der Bildschirm zeigt an, dass die Dateien in das gewählte Verzeichnis übertragen werden.
4. Verlassen	  	Wählen Sie das entsprechende Symbol auf dem Computerbildschirm und wählen Sie „Verlassen“, um die USB-Verbindung zu unterbrechen.

ZWEIJÄHRIGE BESCHRÄNKTE GARANTIE

Sie erhalten für Ihr Bushnell®-Produkt eine Garantie für einen Zeitraum von zwei Jahren ab dem Kaufdatum. Die Garantie erstreckt sich auf Material- und Herstellungsfehler. Für den Fall, dass ein Mangel im Rahmen dieser Garantie auftritt, werden wir das Produkt nach unserer Wahl reparieren oder austauschen, vorausgesetzt, dass Sie das Produkt freigemacht zurückschicken. Von dieser Garantie ausgeschlossen sind Schäden, die auf Missbrauch, unsachgemäße Behandlung, Installations- oder Wartungsarbeiten, die nicht von einer autorisierten Bushnell-Kundendienstabteilung vorgenommen werden, zurückzuführen sind.

Jeder Rücksendung im Rahmen dieser Garantie müssen folgende Dokumente und Angaben beigefügt werden:

- 1) Ein Scheck/eine Zahlungsanweisung in Höhe von 10,00 USD zur Abdeckung der Porto- und Bearbeitungskosten
- 2) Name und Anschrift für die Rücksendung des Produkts
- 3) Eine Erläuterung des Mangels
- 4) Nachweis des Kaufdatums
- 5) Das Produkt sollte zur Vermeidung von Transportschäden gut

verpackt in einem stabilen Versandkarton an die nachstehend aufgeführte Adresse geschickt werden, wobei die Gebühren für die Rücksendung im Voraus zu entrichten sind.

ADRESSE FÜR RÜCKSENDUNGEN IN DIE USA:

Bushnell Performance Optics
Attn.: Repairs
8500 Marshall Drive
Lenexa, Kansas 66214

ADRESSE FÜR RÜCKSENDUNGEN NACH KANADA:

Bushnell Performance Optics
Attn.: Repairs
25A East Pearce Street, Unit 1
Richmond Hill, Ontario L4B 2M9

Bei Produkten, die Sie außerhalb der Vereinigten Staaten oder Kanadas gekauft haben, erhalten Sie die entsprechenden Informationen zur Garantie von ihrem Händler vor Ort. In Europa erreichen Sie Bushnell auch unter:

BUSHNELL Performance Optics Gmbh
European Service Centre
MORSESTRASSE 4
D- 50769 KÖLN
Deutschland
Tél: +49 (0) 221 709 939 3
Fax: +49 (0) 221 709 939 8

Mit dieser Garantie erwerben Sie bestimmte Rechtsansprüche.

Sie haben möglicherweise darüber hinaus noch andere Rechte, die von Land zu Land variieren.

©2004 Bushnell Performance Optics

Bushnell®

ITALIANO



Model: 18-0832

LIT. #: 98-0377/01-04

Manuale di Istruzioni

Congratulazioni per l'acquisto del nuovo binocolo Bushnell! Il binocolo è uno strumento di precisione, concepito e realizzato per offrirle molti anni di piacevoli visioni. Questo manuale l'aiuterà ad ottenere il massimo delle prestazioni, spiegandole come regolare il binocolo per i suoi occhi e come prendersi cura dello strumento. Prima di usare il binocolo, la preghiamo di leggere attentamente queste istruzioni.



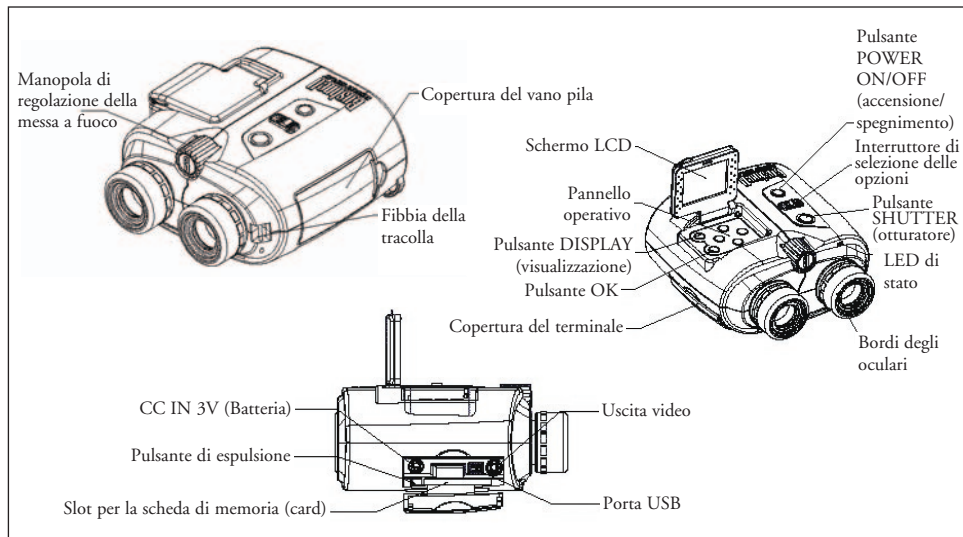

PARTI E NOMI



FUNZIONAMENTO DEL SISTEMA

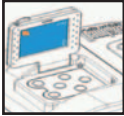

Accensione				Accensione (Adattatore CA/Pila AA)
Registrazione	Registrazione di sequenze video	Riproduzione (Modo fotocamera fissa)	Modo Riproduzione sequenza video	Esportazione immagine/sequenza video
Spostare l'interruttore di selezione delle opzioni sul modo fotocamera fissa	Spostare l'interruttore di selezione delle opzioni sul modo sequenza video	Aprire lo schermo LCD	Aprire lo schermo LCD	Aprire la copertura del terminale
Aprire lo schermo LCD	Aprire lo schermo LCD	Spostare l'interruttore di selezione delle opzioni sul modo fotocamera fissa	Spostare l'interruttore di selezione delle opzioni sul modo sequenza video	Usare il cavo USB per la connessione
Regolare la manopola della messa a fuoco	Premere il pulsante SHUTTER per iniziare la registrazione	Premere il pulsante DISPLAY	Premere il pulsante DISPLAY	In questo modo, il binocolo viene visto come un disco fisso esterno. Potete modificare direttamente la sequenza video e l'immagine
Premere il pulsante SHUTTER	Premere di nuovo il pulsante SHUTTER per arrestare la registrazione	Usare il pannello operativo per selezionare immagine	Usare il pannello operativo per selezionare sequenza video	Uscita
Registrazione l'immagine	È possibile registrare una sequenza video continuata di 30 secondi. Se si superano 30 secondi, il binocolo conserva gli ultimi 30 secondi	Premere il pulsante OK (modo funzione di visualizzazione)	Premere il pulsante OK (modo funzione di visualizzazione)	
		1. Immagine in miniatura 2. Ingrandimento 3. Gestione 4. Impostazione 5. Uscita	1. Immagine in miniatura 2. Gestione 3. Impostazione 4. Uscita	



GUIDA AL FUNZIONAMENTO - Registrazione delle immagini

Procedura operativa	Descrizione dell'immagine	Azione al binocolo
1. Premere il pulsante POWER (alimentazione)		Usare il pulsante POWER per accendere e spegnere il binocolo. Se viene lasciato inattivo per 2 minuti (non è stato usato alcun pulsante o interruttore), LCD si spegne automaticamente per risparmiare energia. Se rimane inattiva per 5 minuti, la fotocamera si spegne per ridurre il consumo di potenza.
2. Spostare l'interruttore di selezione delle opzioni sul modo fotocamera fissa.		Adesso potete riprendere le immagini in modo registrazione. Questa procedura seleziona la registrazione/riproduzione dell'immagine fissa
3. Aprire lo schermo LCD		Comporre le immagini usando lo schermo o gli oculari del binocolo. Mettere a fuoco sempre guardando lo schermo LCD
4. Regolare la manopola di messa a fuoco centrale per far apparire chiara l'immagine sullo schermo LCD		Ruotare la manopola di regolazione della messa a fuoco fino a quando l'immagine appare chiara sullo schermo.

Procedura operativa	Descrizione dell'immagine	Azione al binocolo
5. Premere il pulsante SHUTTER per catturare l'immagine		L'immagine registrata rimane sullo schermo per circa un secondo, poi lo schermo torna al modo originale.





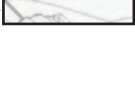

GUIDA AL FUNZIONAMENTO - Registrazione di una sequenza video

Procedura operativa	Descrizione dell'immagine	Azione al binocolo
1. Premere il pulsante POWER		Usare il pulsante POWER per accendere e spegnere il binocolo. Se viene lasciato inattivo per 2 minuti (non è stato usato alcun pulsante o interruttore), LCD si spegne automaticamente per risparmiare energia. Se rimane inattiva per 5 minuti, la fotocamera si spegne per ridurre il consumo di potenza.
2. Spostare l'interruttore di selezione delle opzioni sul modo sequenza video		Adesso potete registrare sequenze video in modo sequenza video. Questa procedura seleziona la registrazione/riproduzione delle sequenze video.
3. Aprire lo schermo LCD		Comporre le immagini usando lo schermo o gli oculari del binocolo. Mettere a fuoco sempre guardando lo schermo LCD.

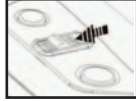
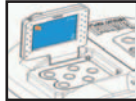
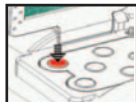
Procedura operativa	Descrizione dell'immagine	Azione al binocolo
4. Regolare la manopola di messa a fuoco centrale per far apparire chiara l'immagine sullo schermo LCD		Ruotare la manopola di regolazione della messa a fuoco fino a quando l'immagine appare chiara sullo schermo.
5. Premere il pulsante SHUTTER		Avviare la registrazione delle sequenze video.
6. Premere di nuovo il pulsante SHUTTER.		Completare la registrazione della sequenza video (la sequenza ha una lunghezza massima di 30 secondi. Instant Replay continuerà a registrare sopra la sequenza precedente fino a quando non viene di nuovo premuto il pulsante SHUTTER per arrestare la registrazione. Pertanto, la memoria interna conterrà sempre i 30 secondi di registrazione più recenti).

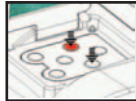
GUIDA AL FUNZIONAMENTO - Riproduzione delle immagini registrate

Procedura operativa	Descrizione dell'immagine	Azione al binocolo
1. Premere il pulsante POWER		Usare il pulsante POWER per accendere e spegnere il binocolo. Se viene lasciato inattivo per 2 minuti (non è stato usato alcun pulsante o interruttore), LCD si spegne automaticamente per risparmiare energia. Se rimane inattiva per 5 minuti, la fotocamera si spegne per ridurre il consumo di potenza.

Procedura operativa	Descrizione dell'immagine	Azione al binocolo
2. Spostare l'interruttore di selezione delle opzioni sul modo fotocamera fissa		Selezionare la registrazione/riproduzione dell'immagine fissa
3. Aprire lo schermo LCD		Guardare le immagini usando lo schermo.
4. Premere il pulsante DISPLAY		L'immagine registrata appare sullo schermo
5. usare i   pulsanti della freccia in alto e della freccia in basso sul pannello operativo per selezionare l'immagine da riprodurre		Visualizzare l'immagine precedente o successiva memorizzata nel binocolo
6. Premere il pulsante OK per ulteriori funzioni di riproduzione		Le voci della funzione di riproduzione appaiono a destra sullo schermo
7. usare i   pulsanti della freccia in alto e della freccia in basso sul pannello operativo per selezionare la funzione desiderata		selezionare la funzione sullo schermo.

Procedura operativa	Descrizione dell'immagine	Azione al binocolo
8. Premere il pulsante OK		Le voci della funzione di visualizzazione appaiono a destra sullo schermo.

GUIDA AL FUNZIONAMENTO - Funzioni

Operating Procedure Funzione Thumbnail



1. Usare i pulsanti del pannello operativo per selezionare un'immagine specifica.
2. Premere il pulsante OK
3. Premere il pulsante OK

Picture Description

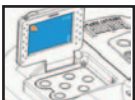





Azione al binocolo
Le voci della funzione di visualizzazione appaiono a destra sullo schermo.

Binocular Action
Visualizza 9 immagini contemporaneamente sullo schermo.

L'immagine al momento selezionata sarà incorniciata (evidenziata).

Il file dell'immagine specifica sarà visualizzato sullo schermo.



Ripristinare il modo di riproduzione delle immagini

Procedura operativa	Descrizione dell'immagine	Azione al binocolo
Funzione Ingrandimento 		Visualizzare l'immagine registrata.
1. Premere il pulsante OK		Visualizzazione ingrandita dell'immagine attuale.
2. Usare i pulsanti del pannello per spostare l'area di visualizzazione in senso verticale o orizzontale		“Freccia in alto”: L'immagine si sposta in alto “Freccia in basso”: L'immagine si sposta in basso “Freccia a sinistra”: L'immagine si sposta a sinistra “Freccia a destra”: L'immagine si sposta a destra
3. Premere il pulsante OK		Ripristinare il modo di riproduzione delle immagini

Procedura operativa	Descrizione dell'immagine	Azione al binocolo
Funzione Delete and Block  <ol style="list-style-type: none"> Usare i pulsanti sul pannello operativo per selezionare l'opzione di gestione dei file Premere il pulsante OK 	  	<p>Visualizzare la schermata della gestione dei file</p> <p>Usare i pulsanti “Freccia in alto” e “Freccia in basso” per selezionare le immagini. Usare i pulsanti “Freccia a sinistra” e “Freccia a destra” per selezionare l'opzione [Exit – Delete – Lock] (Esci-Cancella-Blocca)</p> <p>Andare al modo di riproduzione delle immagini</p>





Procedura operativa	Descrizione dell'immagine	Azione al binocolo
Funzione Set-Up  <ol style="list-style-type: none"> Premere il pulsante DISPLAY Premere il pulsante OK 	  	<p>Non è possibile accedere alla funzione Set-Up se la scheda di memoria non è inserita</p> <p>Visualizzare la schermata di impostazione</p> <p>Se la scheda di memoria è inserita, premere il pulsante OK, quindi usare i pulsanti delle frecce per selezionare le impostazioni</p>



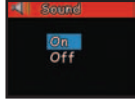

Procedura operativa	Descrizione dell'immagine	Azione al binocolo
Ora e data <ol style="list-style-type: none"> Usare i pulsanti sul pannello operativo per impostare l'ora e la data Premere il pulsante OK 	  	<p>Sullo schermo appare l'impostazione “Format CF”. Impostare le voci alla posizione evidenziata.</p> <p>Usare i pulsanti “Freccia a sinistra” “Freccia a destra” per selezionare la posizione evidenziata. Usare quindi i pulsanti “Freccia in alto” e “Freccia in basso” per cambiare il numero.</p> <p>Tornare al modo di riproduzione immagine fissa</p>

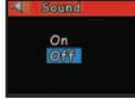
Procedura operativa	Descrizione dell'immagine	Azione al binocolo
Format CF <ol style="list-style-type: none"> Usare i pulsanti sul pannello operativo per selezionare Sì o No. Premere il pulsante OK 	  	<p>The “Format CF” setting shows on the screen. Set items at the highlighting position.</p> <p>Sì – Formatta la scheda CF No – Annulla formattazione</p> <p>Tornare al modo di riproduzione delle immagini</p>





Procedura operativa	Descrizione dell'immagine	Azione al binocolo
Video Out (Uscita video)		Sullo schermo appare l'impostazione Video Out.
1. Usare i   pulsanti sul pannello operativo per selezionare l'impostazione di Video Out		Selezionare PAL se è lo standard del proprio paese (maggior parte dei paesi europei e asiatici)
2. Premere il pulsante OK		Tornare al modo di riproduzione delle immagini.

Risoluzione		Sullo schermo appare l'impostazione della risoluzione. Il valore predefinito è 1600x1200.
1. Usare i   pulsanti sul pannello operativo Azione al binocolo per selezionare l'impostazione della risoluzione.		Descrizione dell'immagine: inserire l'immagine
2. Premere il pulsante OK		Tornare al modo di riproduzione delle immagini.

Procedura operativa	Descrizione dell'immagine	Azione al binocolo
Sonoro		L'impostazione principale del sonoro appare sullo schermo. L'impostazione predefinita è "attivato".
1. Usare i   pulsanti sul pannello operativo per selezionare l'impostazione del sonoro.		L'impostazione principale del sonoro appare sullo schermo. L'impostazione corrente è "disattivato".
2. Premere il pulsante OK		Tornare al modo di riproduzione delle immagini

Luminosità del pannello		L'impostazione della luminosità del pannello appare sullo schermo. La luminosità corrente è identificata dal simbolo a freccia.
1. Usare i   pulsanti sul pannello operativo per selezionare l'impostazione della luminosità.		La luminosità del pannello è controllata dal simbolo a freccia.
2. Premere il pulsante OK		Tornare al modo di riproduzione delle immagini
Uscita		Ripristina il modo di registrazione the capture mode

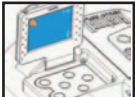
GUIDA AL FUNZIONAMENTO - Riproduzione di sequenze video registrate

Procedura operativa	Descrizione dell'immagine	Azione al binocolo
1. Premere il pulsante POWER		Usare il pulsante POWER per accendere/spengere il binocolo. Se viene lasciato inattivo per 2 minuti (non è stato usato alcun pulsante o interruttore), LCD si spegne automaticamente per risparmiare energia. Se rimane inattiva per 5 minuti, la fotocamera si spegne per ridurre il consumo di potenza.
2. Spostare l'interruttore di selezione delle opzioni sul modo sequenza video		Selezionare la registrazione/riproduzione della sequenza video
3. Aprire lo schermo LCD		Vedere la sequenza sullo schermo del monitor.
4. Premere il pulsante DISPLAY		la sequenza video registrata viene visualizzata sullo schermo

Procedura operativa	Descrizione dell'immagine	Azione al binocolo
5. Usare il pulsante "Freccia a destra" sul pannello operativo per riprodurre la sequenza video		La sequenza viene riprodotta sullo schermo. Al termine, ritorna all'ultima scena.
6. Premere il pulsante OK		Le voci della funzione di visualizzazione appaiono a destra sullo schermo

GUIDA AL FUNZIONAMENTO - Funzioni

Funzione Thumbnail



1. Usare i pulsanti del pannello operativo per selezionare un'immagine specifica.



Visualizza 9 immagini contemporaneamente sullo schermo.









2. Premere il pulsante OK











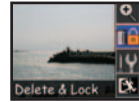
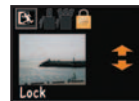







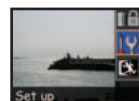



La sequenza video al momento selezionata sarà incorniciata (evidenziata).







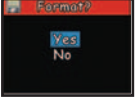



La sequenza video sarà visualizzata sullo schermo.

Procedura operativa	Descrizione dell'immagine	Azione al binocolo
3. Usare il pulsante  sul pannello operativo per riprodurre la sequenza video.		Il monitor visualizza "Loading Movie" (caricamento sequenza) per circa 1 secondo, quindi riproduce la sequenza video
4. Premere il pulsante   OK		La sequenza video registrata viene visualizzata sullo schermo del monitor.
5. Usare il pulsante  sul pannello operativo per riprodurre la sequenza video.		Il monitor visualizza "Loading Movie" (caricamento sequenza) per circa 1 secondo, quindi riproduce la sequenza video
6. Premere il pulsante OK		Tornare al modo riproduzione sequenza video

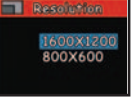
Procedura operativa	Descrizione dell'immagine	Azione al binocolo
Funzione Delete and Lock 		Visualizzare la schermata della gestione dei file
1. Usare i pulsanti sul pannello operativo per selezionare l'opzione di gestione dei file		Usare i pulsanti   per selezionare le immagini. Usare i pulsanti   per selezionare l'opzione [Exit – Delete – Lock] (Esci-Cancella-Blocca)
2. Premere il pulsante OK		Andare al modo di riproduzione sequenza video
Funzione Set-Up 		Non è possibile accedere alla funzione Set-Up se la scheda della memoria non è inserita
1. Premere il pulsante DISPLAY		Visualizzare la schermata di impostazione
2. Premere il pulsante OK		Se la scheda di memoria è inserita, premere il pulsante OK, quindi usare i pulsanti delle frecce per selezionare le impostazioni

Procedura operativa	Descrizione dell'immagine	Azione al binocolo
Ora e data		L'impostazione dell'ora e della data appare sullo schermo. Cambiare il numero nella posizione evidenziata.
1. Usare i pulsanti sul pannello operativo per impostare l'ora e la data		Usare i pulsanti   per selezionare la posizione evidenziata. Usare quindi i pulsanti   per cambiare il numero.
2. Premere il pulsante OK		Tornare al modo di riproduzione sequenza video
Format CF		Sullo schermo appare l'impostazione "Format CF". Impostare le voci alla posizione evidenziata.
1. Usare i pulsanti sul pannello operativo per selezionare Sì o No.		Sì – Formatta la scheda CF No – Annulla formattazione
2. Premere il pulsante OK		Tornare al modo di riproduzione della sequenza video

Procedura operativa	Descrizione dell'immagine	Azione al binocolo
Video Out (Uscita video)		Sullo schermo appare l'impostazione Video Out. L'impostazione predefinita è NTSC (standard video US/Giappone)
1. Usare i pulsanti   sul pannello operativo per selezionare l'impostazione di Video Out		Selezionare PAL se è lo standard del proprio paese (maggior parte dei paesi europei e asiatici)
2. Premere il pulsante OK		Tornare al modo di riproduzione della sequenza video.
Risoluzione		Sullo schermo appare l'impostazione della risoluzione. Il valore predefinito è 1600x1200.
1. Usare i pulsanti   sul pannello operativo per selezionare l'impostazione della risoluzione.		L'impostazione della risoluzione appare sullo schermo. L'impostazione corrente è 800x600.
2. Premere il pulsante OK		Tornare al modo di riproduzione della sequenza video.

Procedura operativa

Descrizione dell'immagine

Azione al binocolo

Sonoro

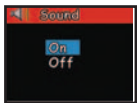

L'impostazione principale del sonoro appare sullo schermo. L'impostazione predefinita è "attivato".

1. Usare i pulsanti   sul pannello operativo per selezionare l'impostazione del sonoro.

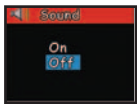

L'impostazione principale del sonoro appare sullo schermo. L'impostazione corrente è "disattivato".

2. Premere il pulsante OK



Tornare al modo di riproduzione della sequenza video

Procedura operativa



Descrizione dell'immagine

Azione al binocolo

Luminosità del pannello



L'impostazione della luminosità del pannello appare sullo schermo. La luminosità corrente è identificata dalla punta di freccia.

1. Usare i pulsanti   sul pannello operativo per selezionare l'impostazione della luminosità.



La luminosità del pannello è controllata dal simbolo a freccia.

2. Premere il pulsante OK







Tornare al modo di riproduzione della sequenza video

Uscita



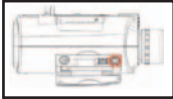

Ripristina il modo di registrazione

GUIDA AL FUNZIONAMENTO - Riproduzione sul televisore

Procedura operativa	Descrizione dell'immagine	Azione al binocolo
1. Collegamento. Collegare al televisore.		Verificare che i pulsanti di accensione del televisore e della fotocamera siano spenti
2. Procedura operativa: aprire la copertura del terminale del dispositivo e collegare il cavo video alla porta uscita video AV.		
3. Collegare l'altra estremità del cavo video alla porta entrata video sul televisore.		
4. Collegare all'adattatore CA (o alla pila)		Mentre le immagini vengono riprodotte sul televisore, l'adattatore può essere alimentato da una qualsiasi presa di corrente per il supporto del dispositivo.
5. Premere il pulsante Power (alimentazione)		
6. Premere il pulsante di alimentazione del televisore		

Procedura operativa	Descrizione dell'immagine	Azione al binocolo
Scollegamento		
1. Verificare che la fotocamera sia spenta.		
2. Rimuovere il cavo video		

GUIDA AL FUNZIONAMENTO - Bassa carica delle pile

1. Premere il pulsante Power		
2. Se la carica delle pile si abbassa, il simbolo della pila sullo schermo lampeggia, viene emesso un segnale acustico di avvertimento e il LED lampeggia		
3. Se le pile si scaricano completamente, il simbolo della pila appare sullo schermo e il dispositivo emette un segnale acustico di avvertimento. Ricaricare immediatamente la pila		

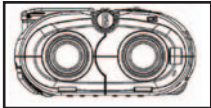
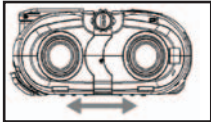

GUIDA AL FUNZIONAMENTO - Regolazione della distanza interpupillare (distanza fra gli occhi)

Procedura operativa	Descrizione dell'immagine	Azione al binocolo
		Regolazione della distanza fra gli occhi – La distanza fra gli occhi, o “ distanza interpupillare”, varia da persona a persona. Per ottenere il perfetto allineamento delle lenti rispetto ai propri occhi, procedere come segue.
1. Tenere il binocolo nella posizione di visione normale.		All'occorrenza, regolare la distanza fra gli oculari, adattandola alla distanza fra gli occhi dell'osservatore.
2. Afferrare saldamente il binocolo, quindi spostarlo in direzione orizzontale fino a quando non si vede un unico campo circolare.		Il binocolo è provvisto di conchiglie oculari per il comfort dell'utente per escludere luci estranee.

PRIMA DI OGNI USO, RIMETTERE SEMPRE IL BINOCOLO IN QUESTA POSIZIONE.

GUIDA AL FUNZIONAMENTO - Regolazione delle diottrie (messa a fuoco)

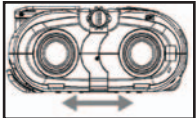
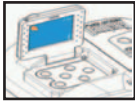
Regolazione diottrica – Poiché ogni persona ha una capacità visiva diversa, la maggior parte dei binocoli è dotata di anelli per la regolazione diottrica, che permettono di regolare la convergenza del sistema ottico secondo la propria capacità visiva. La fotocamera e il binocolo sono regolati in modo da essere a fuoco per persone con vista 10/10 o che usano occhiali da vista. Per adattare il binocolo alla fotocamera può essere necessario eseguire la regolazione sia per l'occhio sinistro che per l'occhio destro, come si farebbe con la maggior parte dei binocoli. Procedete come segue.



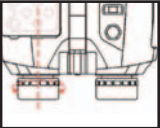
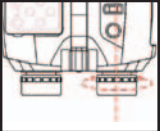

Procedura operativa	Descrizione dell'immagine	Azione al binocolo
a. Premere il pulsante POWER		Usare il pulsante POWER per accendere e spegnere il binocolo. Se viene lasciato inattivo per 2 minuti (non è stato usato alcun pulsante o interruttore), il binocolo si spegne risparmiando energia.
b. Regolare la distanza interpupillare		Regolare la distanza interpupillare del binocolo per la distanza fra i propri occhi
c. Aprire il monitor LCD		Comporre le immagini usando lo schermo del monitor o gli oculari del binocolo
d. Regolare la manopola della messa a fuoco fino a quando l'immagine appare nitida		Ruotare la manopola di regolazione della messa a fuoco fino a quando l'immagine sullo schermo del monitor appare nitida.
e. Osservate, attraverso il binocolo, lo stesso oggetto su cui è messa a fuoco la fotocamera. Se l'oggetto appare distintamente all'occhio sinistro, passate al punto g e poi al punto h, altrimenti passate al punto f e poi al punto g e infine al punto h.		

Procedura operativa	Descrizione dell'immagine	Azione al binocolo
f. Con un cacciavite, allentare la vite di bloccaggio della regolazione della diottria sull'oculare		Attendere che la propria vista si adatti all'osservazione (per primo l'occhio sinistro)
g. Regolare finemente l'oculare sinistro		Regolare fino a trovare la messa a fuoco più nitida
h. Regolare finemente l'oculare destro.		Regolare fino a trovare la messa a fuoco più nitida

Se entrambi i barilotti del binocolo sono in sincronismo fra di loro e con la fotocamera, dovete solo girare l'apposita ghiera centrale per metterli a fuoco tutti e tre. Completata la regolazione, gli oggetti sono chiaramente visibili. Un altro operatore può regolare il binocolo secondo le proprie esigenze visive. Il binocolo è adesso regolato sulla propria visione. Le regolazioni degli oculari non influiscono sulla messa a fuoco della fotocamera.

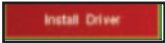

Istruzioni per il collegamento al PC (Installazione del CD)

Se il proprio computer usa il sistema operativo Windows ME, Win2000, o Win XP, saltare questa procedura (il driver è necessario solo per Windows 98)



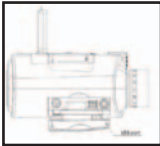

Procedura operativa	Descrizione dell'immagine	Azione al binocolo
1. Accendere il computer.		
2. Mettere il CD nel lettore CD-ROM e il sistema si avvierà automaticamente.		Sul monitor del computer apparirà l'immagine dell'installazione.
3. Selezionare "Install Driver" (installazione driver) per installare il software. Il driver verrà installato nel computer.		Sul monitor del computer apparirà un'immagine di benvenuto.
4. Selezionare "Next" (avanti) per continuare.		
5. Selezionare la voce da installare e cliccare sull'icona "Install" sul monitor del computer.		
6. Selezionare la voce per completare. Uscire dall'immagine di installazione. Cliccare sull'icona di fine.		

AL TERMINE DELL'INSTALLAZIONE, È NECESSARIO RIAVVIARE IL COMPUTER, PRIMA DI COLLEGARE LA FOTOCAMERA E IL CAVO USB.

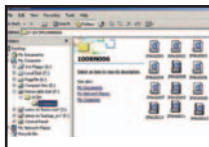
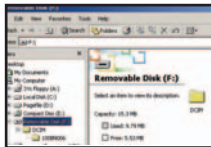
GUIDA AL FUNZIONAMENTO - Trasferimento delle immagini

Procedura operativa	Descrizione dell'immagine	Azione al binocolo
a. Collegare saldamente il cavo USB dalla porta USB di Instant Replay al computer.		La finestra del PC mostrerà “A New Hard Disk Is Found” (trovato nuovo disco fisso) - Usato in questo modo, il binocolo viene visto come un disco fisso esterno – Potete modificare direttamente le sequenze video e le immagini
b. Premere il pulsante POWER su Instant Replay.		
c. Instant Replay verrà riconosciuto come un nuovo dispositivo di memorizzazione (USB), praticamente simile a un disco fisso esterno, che contiene i file delle immagini fisse e delle sequenze video. Usando Windows Explorer o “Risorse del computer”, è possibile vedere il contenuto della scheda CF/memoria interna di Instant Replay, cliccando su un file per vedere le immagini e le sequenze video. È possibile salvarle singolarmente sul disco fisso interno al computer, dopo averle aperte e viste in Microsoft Photo Editor o in un altro programma di grafica. Oppure, si può scegliere di selezionare, in Explorer, alcune o tutte le immagini/sequenze video dei file di Instant Replay e trascinarle o copiarle/incollarle in una cartella del disco fisso, come file normali.		



Procedura operativa	Descrizione dell'immagine	Azione al binocolo
3. Procedura operativa: Trasferire le sequenze video e le immagini al computer		Il monitor mostra il trasferimento in corso dei file alla cartella selezionata Sullo schermo del computer, selezionare l'icona dell'applicazione e selezionare Esci per scollegare il cavo USB.
4. Uscita		
		
		

GARANZIA LIMITATA PER DUE ANNI

Si garantisce che questo prodotto Bushnell® sarà esente da difetti di materiale e fabbricazione per due anni a decorrere dalla data di acquisto. In caso di difetto durante il periodo di garanzia, a nostra discrezione ripareremo o sostituiremo il prodotto purché sia restituito franco destinatario. Sono esclusi dalla garanzia eventuali danni causati da abuso, maneggiamento improprio, installazione o manutenzione eseguiti da persone non autorizzate dal servizio di assistenza Bushnell.

A un prodotto restituito e coperto da questa garanzia occorre allegare quanto segue.

- 1) Assegno/ordine di pagamento per l'importo di 10 \$US per coprire i costi di spedizione.
- 2) Nome e indirizzo da utilizzare per la restituzione del prodotto.
- 3) Una spiegazione del difetto.
- 4) Scontrino riportante la data di acquisto.
- 5) Il prodotto deve essere imballato in una scatola robusta, per prevenire danni durante il trasporto, e va spedito franco destinatario a uno dei seguenti indirizzi.

RECAPITO NEGLI STATI UNITI:

Bushnell Performance Optics
Attn.: Repairs
8500 Marshall Drive
Lenexa, Kansas 66214

RECAPITO IN CANADA:

Bushnell Performance Optics
Attn.: Repairs
25A East Pearce Street, Unit 1
Richmond Hill, Ontario L4B 2M9

Per prodotti acquistati fuori degli Stati Uniti o del Canada, rivolgersi al rivenditore per le clausole pertinenti della garanzia. In Europa si può anche contattare la Bushnell a questo numero:

BUSHNELL Performance Optics GmbH
European Service Centre
MORSESTRASSE 4
D- 50769 - Cologne
Germania
Tél: +49 (0) 221 709 939 3
Fax: +49 (0) 221 709 939 8

Questa garanzia dà specifici diritti legali.
Eventuali altri diritti variano da una nazione all'altra.
©2004 Bushnell Performance Optics

Bushnell®

PORTUGUÊS



18-0832

LIT. #: 98-0377/01-04

Manual de Instruções

Parabéns pela aquisição de seu novo binóculo Bushnell! Ele é um instrumento de precisão projetado para proporcionar muitos anos de observações aprazíveis. Este manual auxiliará você a obter um desempenho excelente explicando o ajuste do binóculo para seus olhos e como cuidar desse instrumento. Leia cuidadosamente as instruções antes de utilizar seu binóculo!

PEÇAS E NOMES

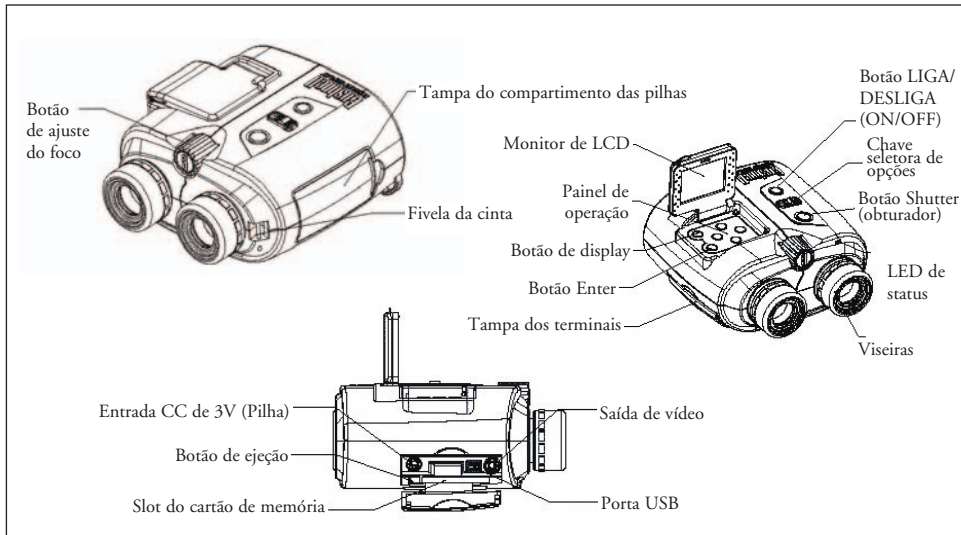





OPERAÇÃO DO SISTEMA

Ligar			
Captura	Captura de filme	Reprodução (Still Camera Mode - Modo de câmera estacionária)	Reprodução (no modo de filme)
Coloque a chave seletora de opção na posição Still Camera Mode (modo de câmera estacionária)	Coloque a chave seletora de opção na posição Movie Mode (modo de filme)	Abra o monitor de LCD	Abra o monitor de LCD
Abra o monitor de LCD	Abra o monitor de LCD	Coloque a chave seletora de opção Still Camera Mode	Coloque a chave seletora de opção na posição Movie Mode (modo de filme)
Ajuste o botão de focalização	Pressione o botão Shutter (obturador) para começar a gravar	Pressione o botão de display	Pressione o botão de display
Pressione o botão Shutter (obturador)	Pressione novamente o botão Shutter (obturador) para interromper a gravação	Use o painel de operação para selecionar a imagem	Use o painel de operação para selecionar o filme
Capture a imagem	Você pode gravar um movie clip com duração de até 30 segundos. Caso ultrapasse este tempo, o binóculo manterá apenas os últimos 30 segundos gravados	Pressione o botão enter (modo da função do display)	Pressione o botão enter (modo da função do display)
		1. Thumbnail (Imagem reduzida) 2. Ampliar 3. Gerenciamento 4. Configuração 5. Sair	1. Thumbnail (Imagem reduzida) 2. Gerenciamento 3. Configuração 4. Sair

Ligar (adaptador CA/Pilha AA)
Exportação de imagens/filme
Abra a tampa de terminais
Use o cabo USB para conectar
Neste modo, o binóculo passa a ser o disco rígido externo. Edite o filme e imagem diretamente
Sair

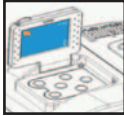
GUIA DE OPERAÇÃO - Captura de imagem

Procedimento de operação	Descrição da fotografia	Ação do binóculo
1. Pressionar o botão POWER (botão de força)		Use o botão POWER (botão de força) para ligar e desligar o binóculo. LCD desligará automaticamente para conservar energia se for deixado inativo (sem que nenhum botão ou chaves sejam operadas) por 2 minutos. Se permanecer inativa por 5 minutos, a câmera desligará a força principal para conservar energia.
2. Coloque o modo de captura da chave seletora de opção na posição Still Camera Mode (Modo de câmera estacionária)		Agora você pode obter imagens no capture mode (modo de captura). Este procedimento seleciona a gravação/reprodução de imagem estacionária
3. Abra o monitor de LCD		Cria imagens usando a tela do monitor ou oculares do binóculo. A focalização sempre deve ser feita observando-se o monitor de LCD
4. Ajustar o botão de focalização central para tornar nítida a imagem desejada no monitor de LCD		Girar o botão de ajuste do foco até que a imagem na tela do monitor fique nítida.

Procedimento de operação

Descrição da fotografia

Ação do binóculo



5. Pressionar o botão shutter (obturador) para tirar a fotografia		A imagem gravada permanece no monitor por aproximadamente um segundo e após retorna ao modo original.
---	---	---



GUIA DE OPERAÇÃO - Captura de filme

Procedimento de operação

Descrição da fotografia



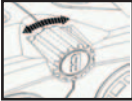





Ação do binóculo

1. Pressionar o botão POWER (botão de força)		Use o botão POWER (botão de força) para ligar e desligar o binóculo. LCD desligará automaticamente para conservar energia se for deixado inativo (sem que nenhum botão ou chaves sejam operadas) por 2 minutos. Se permanecer inativa por 5 minutos, a câmera desligará a força principal para conservar energia.
2. Coloque o Movie mode (modo de filme) da chave seletora de opção na posição Movie mode		Agora você pode gravar filmes no Movie mode. Este procedimento seleciona a gravação/reprodução de filmes.
3. Abra o monitor de LCD		Cria imagens usando a tela do monitor ou ocular do binóculo. A focalização deve sempre ser feita observando-se o monitor de LCD.

Procedimento de operação	Descrição da fotografia	Ação do binóculo
4. Ajustar o botão de focalização central para tornar nítida a imagem desejada no monitor de LCD.		Girar o botão de ajuste do foco até que a imagem na tela do monitor esteja nítida.
5. Pressionar o botão shutter (obturador)		Começar a gravar filmes.
6. Pressionar novamente o botão shutter (obturador).		Terminar de gravar o filme. (A duração máxima do filme é de 30 segundos. O Instant Replay (reprodução instantânea) continuará gravando sobre o filme anterior até que o botão shutter (obturador) seja pressionado uma segunda vez para suspender a gravação. Sendo assim, a memória interna sempre manterá os últimos 30 segundos da ação gravada.

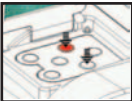



GUIA DE OPERAÇÃO - Reprodução das imagens gravadas





Procedimento de operação	Descrição da fotografia	Ação do binóculo
1. Pressionar o botão POWER (botão de força)		Use o botão POWER (botão de força) para ligar e desligar o binóculo. LCD desligará automaticamente para conservar energia se for deixado inativo (sem que nenhum botão ou chaves sejam operadas) por 2 minutos. Se permanecer inativa por 5 minutos, a câmera desligará a força principal para conservar energia.



Procedimento de operação	Descrição da fotografia	Ação do binóculo
2. Coloque o capture mode (modo de captura) da chave seletora de opção na posição Still Camera Mode (modo de câmera estacionária)		Seleciona a gravação/reprodução de imagem still (estacionária).
3. Abra o monitor de LCD		Visualizar imagens usando a tela do monitor.
4. Pressionar o botão do display		A imagem gravada é exibida no monitor
5. Use os botões   no painel de operação para selecionar a imagem a ser reproduzida		Exibir a imagem anterior ou a próxima armazenada no binóculo.
6. Pressionar o botão enter para funções de reprodução adicionais		Os itens da função de reprodução aparecem no lado direito da tela
7. Use os botões   no painel de operação para selecionar a função desejada		Selecionar a função na tela.



Procedimento de operação	Descrição da fotografia	Ação do binóculo
8. Pressionar o botão enter		Os itens da função do display aparecem no lado direito da tela.

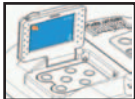

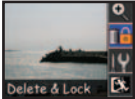
GUIA DE OPERAÇÃO - Funções

Procedimento de operação	Descrição da fotografia	Ação do binóculo
Função Thumbnail (Imagem Reduzida)		
		
1. Use os botões do painel de operação para selecionar uma imagem específica		Isto exibe 9 imagens no monitor ao mesmo tempo.
		A imagem atualmente selecionada será destacada.
2. Pressionar o botão enter		O arquivo da imagem específica é exibido na tela do monitor.
3. Pressionar o botão enter		Restaurar o playback images mode (modo de reprodução de imagens)

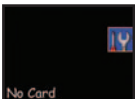



Procedimento de operação	Descrição da fotografia	Ação do binóculo
Função Ampliar		
		
1. Pressionar o botão enter		Exibir a imagem gravada.
		Exibir a imagem que está ampliada.
2. Usar os botões do painel para movimentar a área de display vertical ou horizontalmente.		“Seta para cima”: a imagem se desloca para cima. “Seta para baixo”: A imagem de desloca para baixo. “Seta para a esquerda”: A imagem se desloca para a esquerda. “Seta para a direita”: A imagem se desloca para a direita
3. Pressionar o botão enter		Restaurar o playback images mode (modo de reprodução de imagens)

Procedimento de operação	Descrição da fotografia	Ação do binóculo
Função Delete and Lock (Remover e Bloquear) 	  	<p>Exibe a tela de gerenciamento de arquivos</p> <p>Usar os botões “Seta para cima” e “Seta para baixo” para selecionar imagens. Usar os botões “Seta para a esquerda” e “Seta para a direita” para selecionar a opção [Exit – Delete – Lock] (Sair – Remover – Bloquear)</p> <p>Restaurar o playback images mode (modo de reprodução de imagens)</p>
<ol style="list-style-type: none"> Use os botões do painel de operação para selecionar a opção de gerenciamento de arquivos Pressionar o botão enter 		





Procedimento de operação	Descrição da fotografia	Ação do binóculo
Função de Set-up (Configuração) 	  	<p>Não é possível acessar a função de configuração se o cartão de memória não estiver inserido</p> <p>Exibir a tela de configuração</p> <p>Se o cartão de memória estiver inserido, pressione o botão enter e após use os botões de setas para selecionar as configurações</p>
<ol style="list-style-type: none"> Pressionar o botão de display Pressionar o botão enter 		

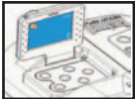

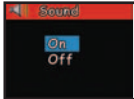

Procedimento de operação	Descrição da fotografia	Ação do binóculo
Hora e data	  	<p>A configuração da hora e data aparece na tela. Mude o número na posição destacada.</p> <p>Usar os botões “Seta para a esquerda” e “Seta para a direita” para selecionar a posição destacada. Use os botões “Seta para cima” e “Seta para baixo” para mudar o número.</p> <p>Retorna ao image playback mode (modo de reprodução de imagem estacionária)</p>
<ol style="list-style-type: none"> Use os botões do painel de operação para ajustar a Hora e a Data Pressionar o botão enter 		

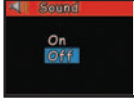
Procedimento de operação	Descrição da fotografia	Ação do binóculo
Formatar CF	  	<p>A configuração “Format CF” (Formatar CF) aparece na tela. Configure os itens na posição destacada.</p> <p>Sim – Formatar cartão CF Não – Cancelar formatação</p> <p>Retornar ao image playback mode (modo de reprodução de imagem)</p>
<ol style="list-style-type: none"> Use os botões do painel de operação para selecionar Yes (Sim) ou No (Não). Pressionar o botão enter 		





Procedimento de operação	Descrição da fotografia	Ação do binóculo
Saída de vídeo		A configuração de saída de vídeo aparece na tela. O padrão é NTSC (padrão de vídeo nos EUA/Japão)
1. Use os botões   no painel de operação para selecionar a configuração de saída de vídeo		Selecione PAL caso seja este o padrão utilizado em seu país (PAL é utilizado na maioria dos países da Europa e Ásia)
2. Pressionar o botão enter		Retornar ao modo de reprodução de imagem.

Resolução		A configuração da resolução aparece na tela. O padrão é 1600x1200.
1. Use os botões   no painel de operação para selecionar a configuração da resolução		A configuração da resolução aparece na tela.. A atual configuração é 800x600.
2. Pressionar o botão enter		Retornar ao playback images mode (modo de reprodução de imagens)

Procedimento de operação	Descrição da fotografia	Ação do binóculo
Som		A principal configuração de som aparece na tela. O padrão é on (ligado).
1. Use os botões   no painel de operação para selecionar a configuração de resolução.		A principal configuração de som aparece na tela. A atual configuração é off (desligado).
2. Pressionar o botão enter		Retornar ao playback images mode (modo de reprodução de imagens)

Brilho do painel		A configuração de brilho do painel aparece na tela. O brilho atual é identificado pela ponta da flecha.
1. Use os botões   no painel de operação para selecionar a configuração de resolução		O brilho do painel é controlado pela ponta da flecha.
2. Pressionar o botão enter		Retornar ao playback images mode (modo de reprodução de imagens)
Sair		Restabelece o capture mode (modo de captura)

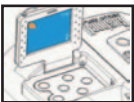
GUIA DE OPERAÇÃO - Reprodução dos filmes gravados

Procedimento de operação	Descrição da fotografia	Ação do binóculo
1. Pressionar o botão POWER (botão de força)		Use o botão POWER (botão de força) para ligar e desligar o binóculo. LCD desligará automaticamente para conservar energia se for deixado inativo (se nenhum botão ou chaves forem operadas) por 2 minutos. Se permanecer inativa por 5 minutos, a câmera desligará a força principal para conservar energia.
2. Coloque o modo de filme da chave seletora de opção na posição Movie Mode (modo de filme)		Seleciona a gravação/reprodução de filme.
3. Abra o monitor de LCD monitor.		Visualizar o filme usando a tela do
4. Pressionar o botão do display		O filme gravado é exibido no monitor

Procedimento de operação

Descrição da fotografia

Ação do binóculo

5. Use o botão “Seta para a direita” no painel de operação para reproduzir o filme



A tela do monitor está apresentando o filme. Quando ele tiver concluído, voltará para a última cena.

6. Pressionar o botão enter



Os itens da função do display aparecem no lado direito da tela

GUIA DE OPERAÇÃO - Funções

Função Thumbnail (Imagem Reduzida)



1. Use os botões do painel de operação para selecionar o filme.



Exibe 9 filmes no monitor a mesmo tempo.





2. Pressionar o botão enter do









O filme atualmente selecionado será destacado.

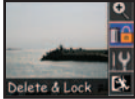











O filme gravado é exibido na tela monitor.



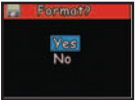

Procedimento de operação	Descrição da fotografia	Ação do binóculo
3. Use o botão  no painel de operação para reproduzir o filme.		O monitor exibe "Loading Movie" (Carregando o filme) por aproximadamente 1 segundo e após começa a apresentá-lo.
4. Usar os botões   para selecionar o filme		O filme gravado é exibido no monitor
5. Use o botão  no painel de operação para reproduzir o filme		O monitor exibe "Loading Movie" (Carregando o filme) por aproximadamente 1 segundo e após começa a apresentá-lo.
6. Pressionar o botão enter		Retornar ao movie playback mode (modo de reprodução do filme)

Procedimento de operação	Descrição da fotografia	Ação do binóculo
Função Delete and Lock (Remover e Bloquear) 		Exibe a tela de gerenciamento de arquivos
1. Use os botões do painel de operação para selecionar a opção de gerenciamento de arquivos		Usar os botões   para selecionar o filme. Usar os botões   para selecionar a opção [Exit- Delete – Lock] (Sair – Remover – Bloquear)
2. Pressionar o botão enter		Retornar ao modo de reprodução do filme





Procedimento de operação	Descrição da fotografia	Ação do binóculo
Função Set-Up (Configuração) 		Não é possível acessar a função de configuração se o cartão de memória não estiver inserido
1. Pressionar o botão de display		Exibir a tela de configuração
2. Pressionar o botão enter		Se o cartão de memória estiver inserido, pressione o botão enter e após use os botões de setas para selecionar as configurações





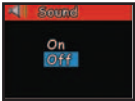

Procedimento de operação	Descrição da fotografia	Ação do binóculo
Hora e data		As configuração da hora e da data aparece na tela. Mude o número na posição destacada.
1. Use os botões do painel de operação para ajustar a Hora e a Data		Usar os botões   para selecionar a posição destacada. Use os botões   para mudar o número.
2. Pressionar o botão enter		Retorna ao movie playback mode (modo de reprodução de filme)

Formatar CF		A configuração "Format CF" (Formatar CF) aparece na tela. Configure os itens na posição destacada.
1. Use os botões do painel de operação para selecionar Yes (Sim) ou No (Não).		Sim – Formatar cartão CF Não – Cancelar formatação
2. Pressionar o botão enter		Retorna ao movie playback mode (modo de reprodução do filme)



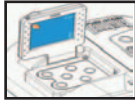

Procedimento de operação	Descrição da fotografia	Ação do binóculo
Saída de vídeo		A configuração de saída de vídeo aparece na tela. O padrão é NTSC (padrão de vídeo nos EUA/Japão)
1. Use os botões   no painel de operação para selecionar a configuração de saída de vídeo		Selecione PAL caso seja o padrão utilizado em seu país (PAL é utilizado na maioria dos países da Europa e Ásia)
2. Pressionar o botão enter		Retorna ao movie playback mode (modo de reprodução do filme).

Resolução		A configuração de resolução aparece na tela. O padrão é 1600x1200.
1. Use os botões   no painel de operação para selecionar a configuração da resolução		A configuração da resolução aparece na tela.. A atual configuração é 800x600.
2. Pressionar o botão enter		Retorna ao movie playback mode (modo de reprodução do filme)

Procedimento de operação	Descrição da fotografia	Ação do binóculo
Som		A principal configuração de som aparece na tela. O padrão é on (ligado).
1. Use os botões   no painel de operação para selecionar a configuração de resolução		A principal configuração de som aparece na tela. A atual configuração é off (desligado).
2. Pressionar o botão enter		Retorna ao movie playback mode (modo de reprodução do filme)

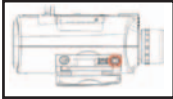
Procedimento de operação	Descrição da fotografia	Ação do binóculo
Brilho do painel		A configuração de brilho do painel aparece na tela. O brilho atual é identificado pela ponta de flecha.
1. Use os botões   no painel de operação para selecionar a configuração de resolução		O brilho do painel é controlado pela ponta da flecha.
2. Pressionar o botão enter		Retorna ao movie playback mode (modo de reprodução do filme)
Sair		Restabelece o movie capture mode (modo de captura de filme)

GUIA DE OPERAÇÃO - Reprodução na TV

Procedimento de operação	Descrição da fotografia	Ação do binóculo
1. Conectar. Conexão na TV Descrição da fotografia		Certifique-se de que a TV e a câmera estejam desligadas
2. Abra a tampa de terminais do dispositivo e conecte o cabo de vídeo à porta de saída AV.		
3. Conecte a outra extremidade do cabo de vídeo na porta na TV.		
4. Conecte ao adaptador CA (ou pilha)		
5. Pressionar o botão Power (botão de força)		
6. Pressionar o botão de força da TV		

Procedimento de operação

Descrição da fotografia

Ação do binóculo

Desconectar:

1. Certifique-se de que a câmera está desligada.
2. Remova o cabo do vídeo



GUIA DE OPERAÇÃO - Condição de baixa carga da pilha

1. Pressionar o botão Power (botão de força)



2. Se a carga da pilha reduzir, o símbolo da pilha começará a piscar na tela, será enviado um ruído de advertência e o LED piscará



3. Se as pilhas ficarem totalmente sem carga, o símbolo da pilha aparecerá na tela e o dispositivo enviará um ruído de advertência. Recarregue a pilha imediatamente.



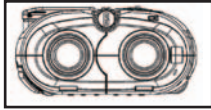
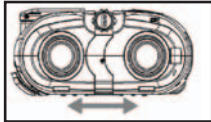

GUIA DE OPERAÇÃO - Ajuste da IPD (distância interpupilar)

Procedimento de operação	Descrição da fotografia	Ação do binóculo
<p>Como ajustar a distância entre seus olhos – A distância entre os olhos, denominada “distância interpupilar” (Interpupillary Distance - IPD), varia de pessoa para pessoa. Siga as etapas simples a seguir para obter um alinhamento perfeito entre as lentes e seus olhos:</p>		
1. Mantenha o binóculo na posição normal de observação		A distância entre os olhos deve ser ajustada de acordo com a distância interpupilar do usuário.
2. Segurando o binóculo com firmeza, movimente-o horizontalmente até enxergar um campo circular único.		O binóculo possui viseiras projetadas para o seu conforto e para eliminar a luz externa supérflua.

SEMPRE RECOLOQUE NESTA POSIÇÃO ANTES DE USAR

GUIA DE OPERAÇÃO - Ajuste de dioptria (Focalização)

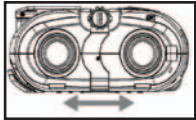
Ajuste para a visão individual - Como a visão varia de uma pessoa para outra, a maioria dos binóculos possui um recurso de ajuste de dioptria permitindo ajustar os binóculos à sua visão. A câmara e o binóculo são configurados para estarem em foco para os indivíduos com visão de 20/20 ou visão corrigida. Talvez seja necessário fazer o ajuste de foco da câmara para ambos os olhos, assim como é feito no caso de binóculos. Siga as instruções de focalização abaixo para o seu tipo específico de binóculo.



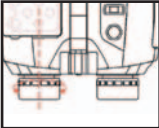
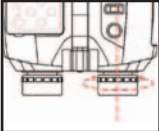

Procedimento de operação	Descrição da fotografia	Ação do binóculo
a. Pressione o botão POWER (botão de força)		Use o botão POWER (botão de força) para ligar e desligar o binóculo. O binóculo desligará automaticamente para conservar energia se for deixado inativo (sem que nenhum botão ou chaves sejam operadas) por 2 minutos.
b. Ajuste a distância interpupilar.		A distância entre os olhos deve ser ajustada de acordo com a distância interpupilar do usuário.
c. Abra o monitor de LCD		Crie imagens usando a tela do monitor ou oculares do binóculo.
d. Configure o botão de ajuste para tornar a imagem nítida		Gire o botão de ajuste do foco até que a imagem na tela do monitor fique nítida.
e. Pelo binóculo, olhe para o mesmo objeto que a câmara está focando. Se o objeto estiver claro para o seu olho esquerdo, proceda para as etapas g e h. Caso contrário, proceda para a etapa f e após para as etapas g e h.		

Procedimento de operação	Descrição da fotografia	Ação do binóculo
f. Afrouxe o parafuso de aperto com a chave de fenda.		Permita que sua visão se ajuste ligeiramente (primeiro o olho esquerdo)
g. Ajuste levemente o olho esquerdo.		Ajuste a dioptria para encontrar o foco mais nítido
h. Ajuste levemente o olho direito.		Ajuste para encontrar o foco mais nítido. Se ambos os cilindros do binóculo estiverem sincronizados entre si e com a câmera, será necessário apenas girar o botão central de foco para ajustar o foco dos três.

Após o ajuste você poderá ver objetos com nitidez. Um outro usuário poderá fazer ajustes de acordo com suas necessidades. Agora o binóculo está configurado para a sua visão individual. Os ajustes da ocular não afetarão o foco da câmera.

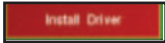

Instruções de conexão ao PC (Instalação do CD)

Pule este processo se o sistema operacional de seu computador for Windows ME, Win2000 ou Win XP (o driver é necessário somente para o Windows 98)

Procedimento de operação	Descrição da fotografia	Ação do binóculo
1. Ligue o computador.		O monitor do computador indicará a imagem de Instalação.
2. Coloque o CD na unidade de CD-Rom e o sistema rodará automaticamente.		O monitor do computador exibirá uma imagem de boas-vindas.
3. Selecione "Install Driver" (Instalar driver) para instalar o software. Isto instalará o driver em seu computador.		
4. Selecione "Next" (Avançar) para continuar.		
5. Selecione o item a ser instalado e clique no ícone "Install" (Instalar) no monitor do computador.		
6. Selecione o item para finalizar. Saia da imagem de instalação. Clique no ícone Finish (Concluir)		

SERÁ NECESSÁRIO REINICIALIZAR O COMPUTADOR APÓS CONCLUIR A INSTALAÇÃO E ANTES DE CONECTAR A CÂMERA E O CABO USB.

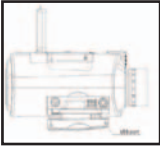
GUIA DE OPERAÇÃO - Transferência de imagens

Procedimento de operação	Descrição da fotografia	Ação do binóculo
a. Conecte o cabo USB com segurança, da porta USB da Instant Replay ao computador.		A janela do PC indicará “A New Hard Disk Is Found” (Foi encontrado um novo disco rígido) (Neste modo, o binóculo passa a ser o disco rígido externo. – Edite os filmes e imagens diretamente
b. Pressione o botão POWER (botão de força) na Instant Replay		
c. A Instant Replay será reconhecida com um novo dispositivo de armazenamento (USB), que basicamente não difere de uma unidade rígida externa, e que contém seus arquivos de imagem still (estacionária) e filmes. Usando o Windows Explorer ou “Meu Computador”, você poderá visualizar o conteúdo do cartão CF de Instant Replay/memória interna clicando em qualquer arquivo para visualizar imagens e filmes. Será possível salvá-los individualmente na unidade rígida interna após abri-los e visualizá-los no Microsoft Photo Editor ou em algum outro programa gráfico. Você poderá também selecionar certos ou todos os arquivos da Instant Replay no Explorer e arrastá-los ou copiar/colar em um arquivo no disco rígido, da mesma forma como seria feito com qualquer outro arquivo normal.		

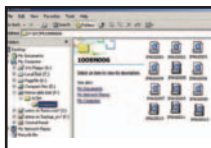
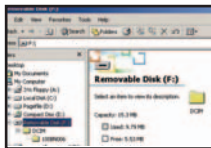

Procedimento de operação	Descrição da fotografia	Ação do binóculo
3. Transfira os filmes e imagens ao computador		O monitor indica a transferência de arquivos para a pasta selecionada
4. Sair	  	Selecione o ícone da barra de tarefas na tela do computador e selecione sair para desconectar o cabo USB.

GARANTIA LIMITADA DE DOIS ANOS

Garantimos que seu produto Bushnell® estará isento de defeitos materiais e de fabricação. por dois anos após a data de aquisição. Caso tenha algum um defeito sob esta garantia, iremos a nossa opção, consertar ou trocar este produto desde que o produto seja devolvido com porte pago. Esta garantia não abrange danos causados por uso indevido, operação, instalação, ou manutenção incorretas efetuadas a não ser que seja do Departamento do Serviço de Manutenção Autorizada da Bushnell.

Qualquer devolução efetuada sob esta garantia deve incluir os itens relacionados a seguir:

- 1) Um cheque/ordem de pagamento no montante de \$10,00 para cobrir as despesas de porte e gastos administrativos
- 2) Nome e endereço para a devolução do produto
- 3) Uma explicação do defeito
- 4) Comprovante da Data de Aquisição
- 5) O produto deve ser cuidadosamente embalado, numa caixa de papelão resistente para prevenir danos enquanto em trânsito e enviado para os endereços indicados a seguir com porte de devolução pago:

NOS EUA REMETER PARA:

Bushnell Performance Optics
Attn.: Repairs
8500 Marshall Drive
Lenexa, Kansas 66214

NO CANADÁ REMETER PARA:

Bushnell Performance Optics
Attn.: Repairs
25A East Pearce Street, Unit 1
Richmond Hill, Ontario L4B 2M9

Para produtos adquiridos fora dos Estados Unidos ou do Canadá favor contatar seu revendedor local quanto a informações aplicáveis referentes a su garantia. A Bushnell também pode ser contatada na Europa pelo telefone:

BUSHNELL Performance Optics GmbH
European Service Centre
MORSESTRASSE 4
D- 50769 KÖLN
Alemanha
Tél: +49 (0) 221 709 939 3
Fax: +49 (0) 221 709 939 8

Esta garantia lhe dá direitos legais específicos.
Poderá ter outros direitos que podem variar de país para país.
©2004 Bushnell Performance OpticS

NOTES



www.bushnell.com

©2004 Bushnell Performance Optics