

DAEWOO

VACUUM CLEANER

RC-700

OWNER'S MANUAL

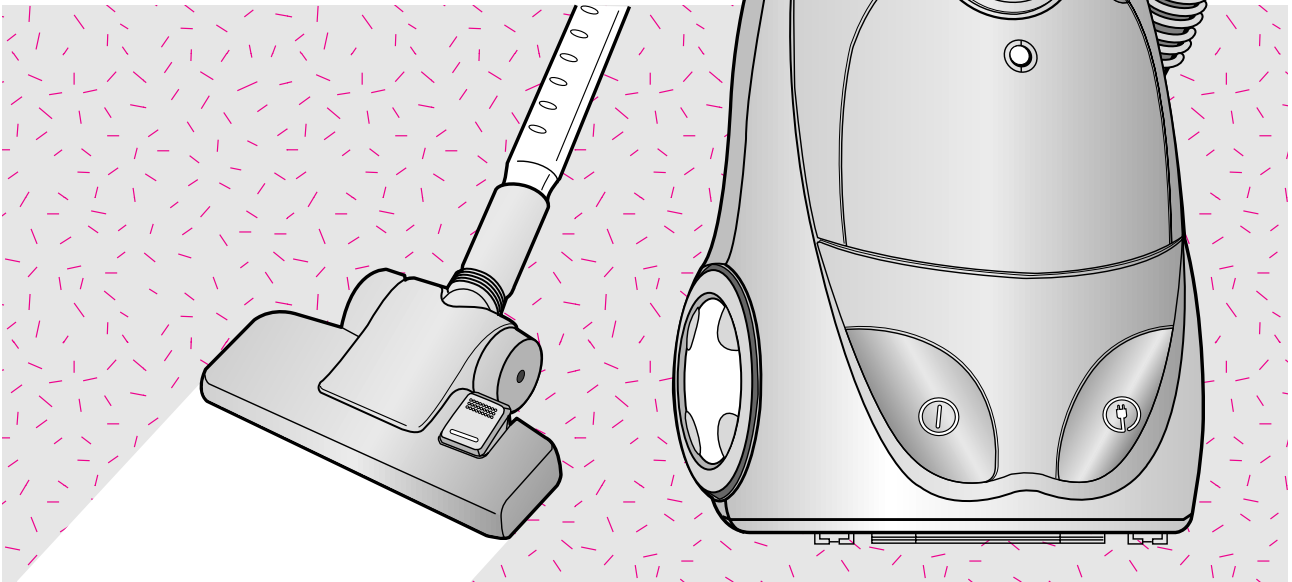

■ For proper use of the appliance, please read this manual carefully in advance.

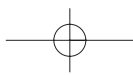

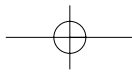

INFORMATION FOR SAFE USE

Please read the following information carefully. It provides important instructions for the safety, use and maintenance of the appliance.

WARNING - To reduce the risk of fire, electric shock, or injury

1. In order to ensure safety, the appliance should only be assembled as set out in the instructions for use and connected and operated in accordance with the model plate.
2. Do not use the appliance if it is damaged.
3. Before starting the appliance, it should be ensured that the filters are correctly positioned.
4. Do not vacuum any sharp-edged, hot or incandescent materials. Do not vacuum any moist or liquid substances. Do not vacuum any highly flammable or explosive materials or gases.
5. Do not use the vacuum cleaner without the filter and dust bag.
6. Children should only be permitted to use electrical appliances under supervision.
7. When the appliance is in operation, the nozzles and pipes must be kept away from the head.
8. The appliance should be switched off and the plug pulled out before any cleaning or maintenance work is carried out.
9. The appliance should only be cleaned with a dry or damp cloth; it should never be immersed in water.
10. Should the appliance malfunction, it should be disconnected from the mains (by pulling out the plug).
11. Do not use the mains wire to carry the appliance.
12. Caution is required when vacuuming stairs.
13. The appliance should be switched off when not in use. The appliance should not be exposed to weather, moisture or heat.
14. Pull the plug, not the mains cable, in order to disconnect the appliance from the mains.
15. Only qualified personnel or customer service should perform repairs, change replacement parts or work on the appliance.
16. Worn-out appliances should be rendered unserviceable immediately and then disposed of correctly.

SAVE THESE INSTRUCTIONS

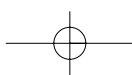

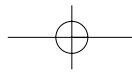

OVERVIEW AND ASSEMBLY

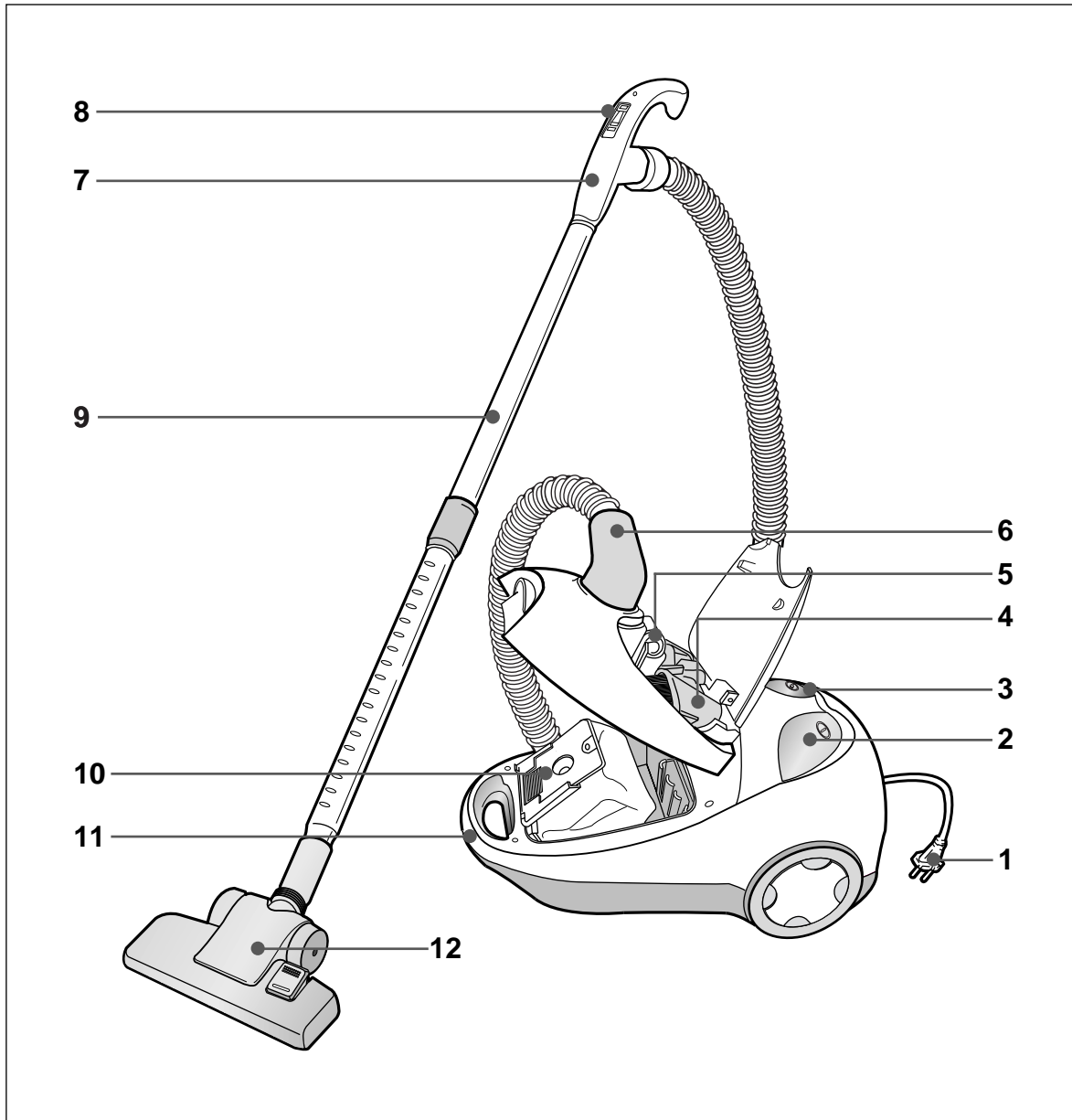

	Page		Page
1. Power cord		7. Hose handle	
2. Power On/Off button		8. Control handle	
3. Power cord rewind button		9. Telescopic pipe	
4. Accessories		10. Dust bag	
5. Dust meter		11. Handle	
6. Hose adapter		12. Brush	
		13. Motor filter	

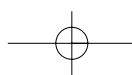

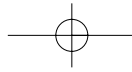

USING FOR THE FIRST TIME

Lift the cover of the Dust bag compartment and check that the Dust bag is good place.
Connect the Hose adapter into the main body
When removing the Hose adapter press the lever by pulling out the Hose adapter.

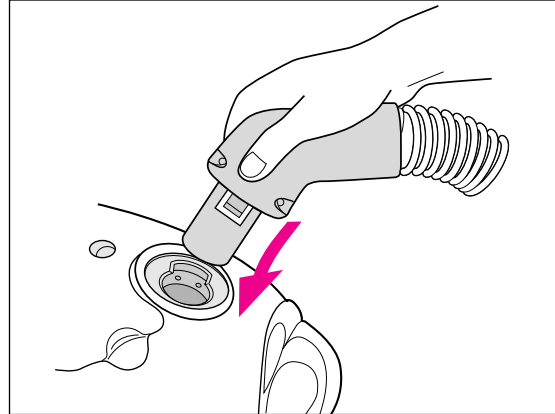

Assemble the Hose handle and Brush with Telescopic pipe.
Adjust the length of the Telescopic pipe by pressing the lever on the pipe.

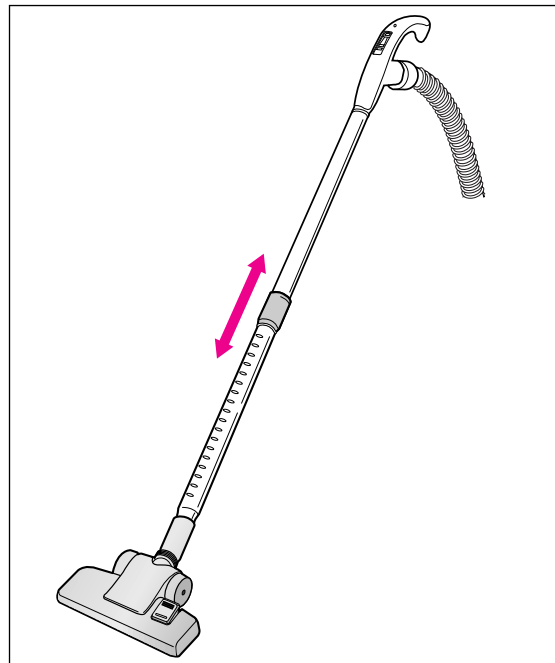

Extend the Power cord and connect it to the mains.
The Power cord can be rewind automatically by pressing the Power cord rewind button(↓)

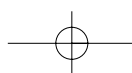
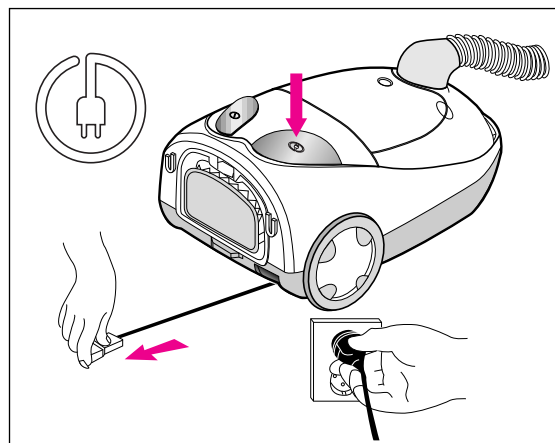

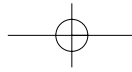

The appliance is switched on and off by pushing the Power on/off button by turns on the main body. The suction power can be adjusted by sliding the power control pad on the Control handle.

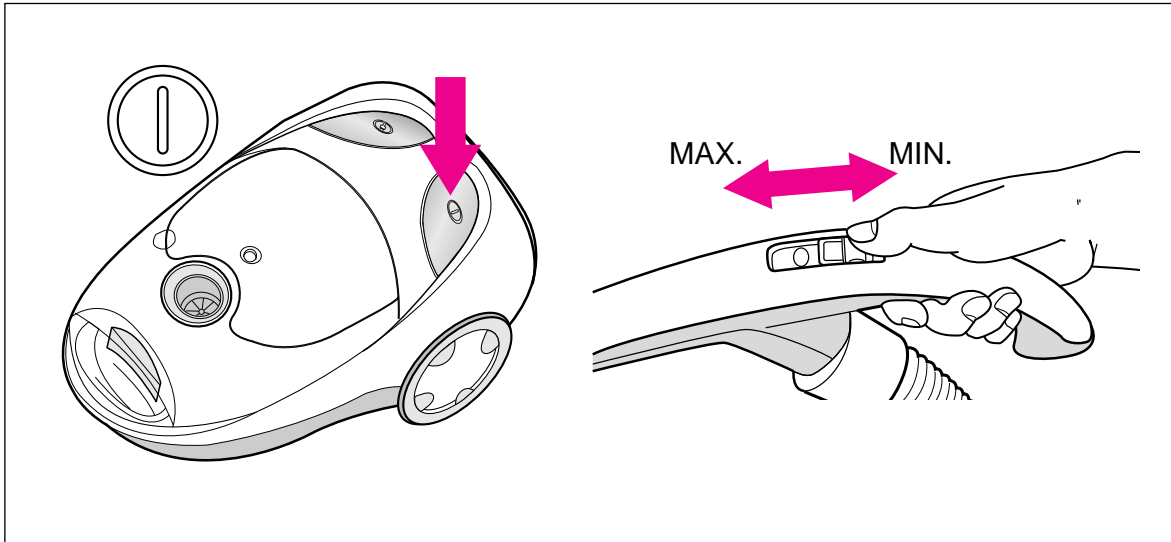

The brush is adjusted for hard floor or carpeted floor by using the function selection pedal on the brush.

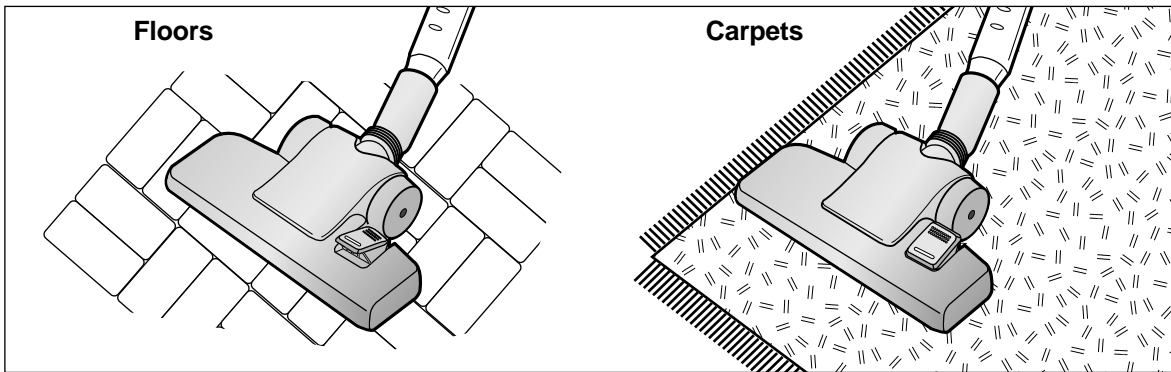

Attention!

Don't vacuum any moist or liquid substances.
Don't use for broken glasses or sharp objects.

Don't vacuum ash, inflammable liquid or gas.
Make sure that the ventilation outlet is not blocked or obstructed during operation.

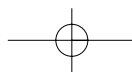
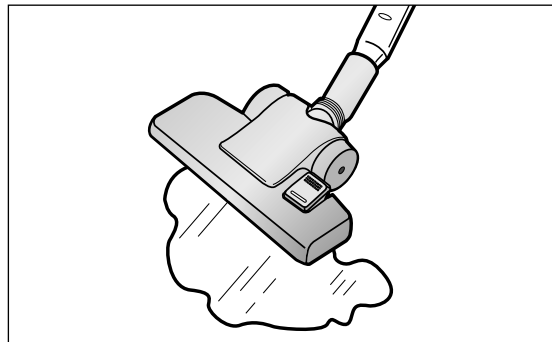

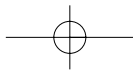

Storage

Before storing this appliance:

- Switch off the appliance.
- Disconnect the Power cord from the mains
- Rewind the Power cord

The appliance can be stored in a vertical or horizontal position.

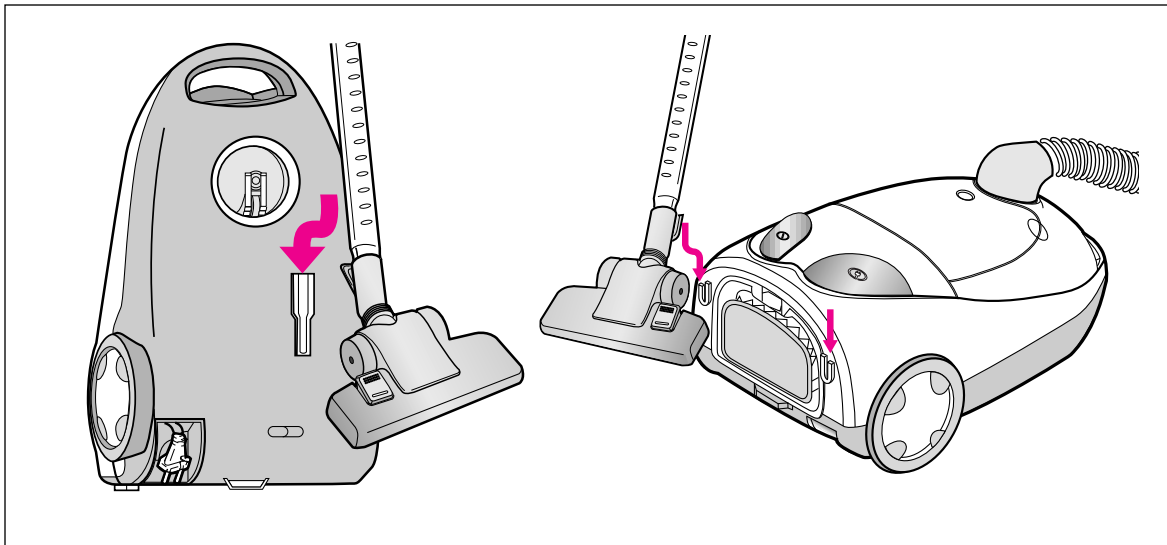

Accessories

- Dusting brush (A)
- Upholstery nozzle (B)
- Crevice nozzle (C)

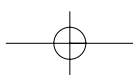
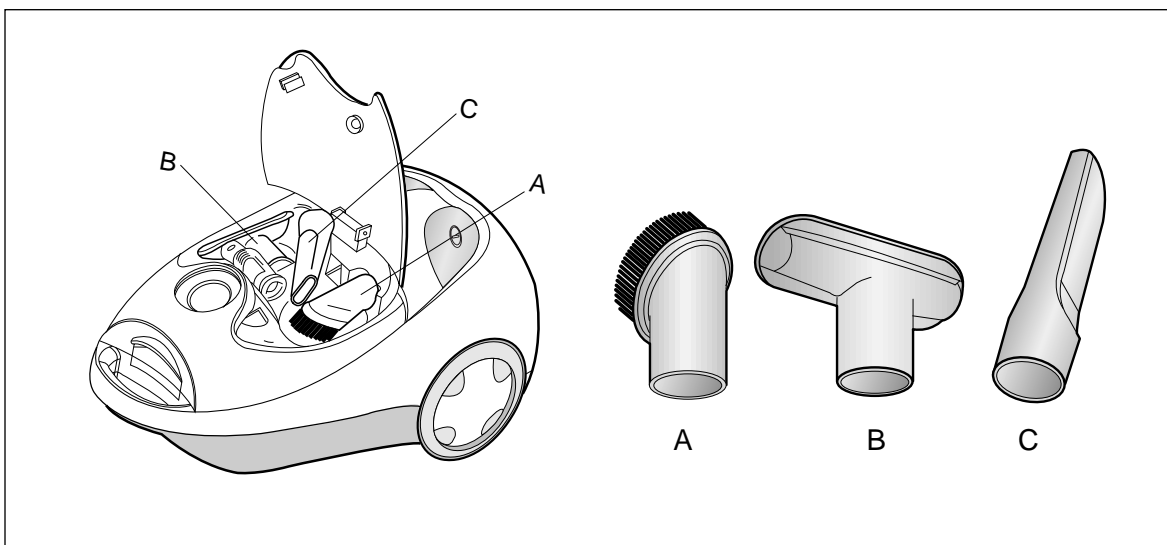

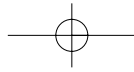

Change and cleaning of filters

When color on the Dust meter is turned into red, change the dust bag with new one.

- Disassemble the Hose adapter from the main body.
- Open the cover of Dust bag compartment.
- Cover the hole of Dust bag by pulling up the dust bag closer.
- Put a new dust bag by slotting the cardboard into the holder. The cover can be closed only when the Dust bag is fitted in good position.

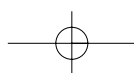
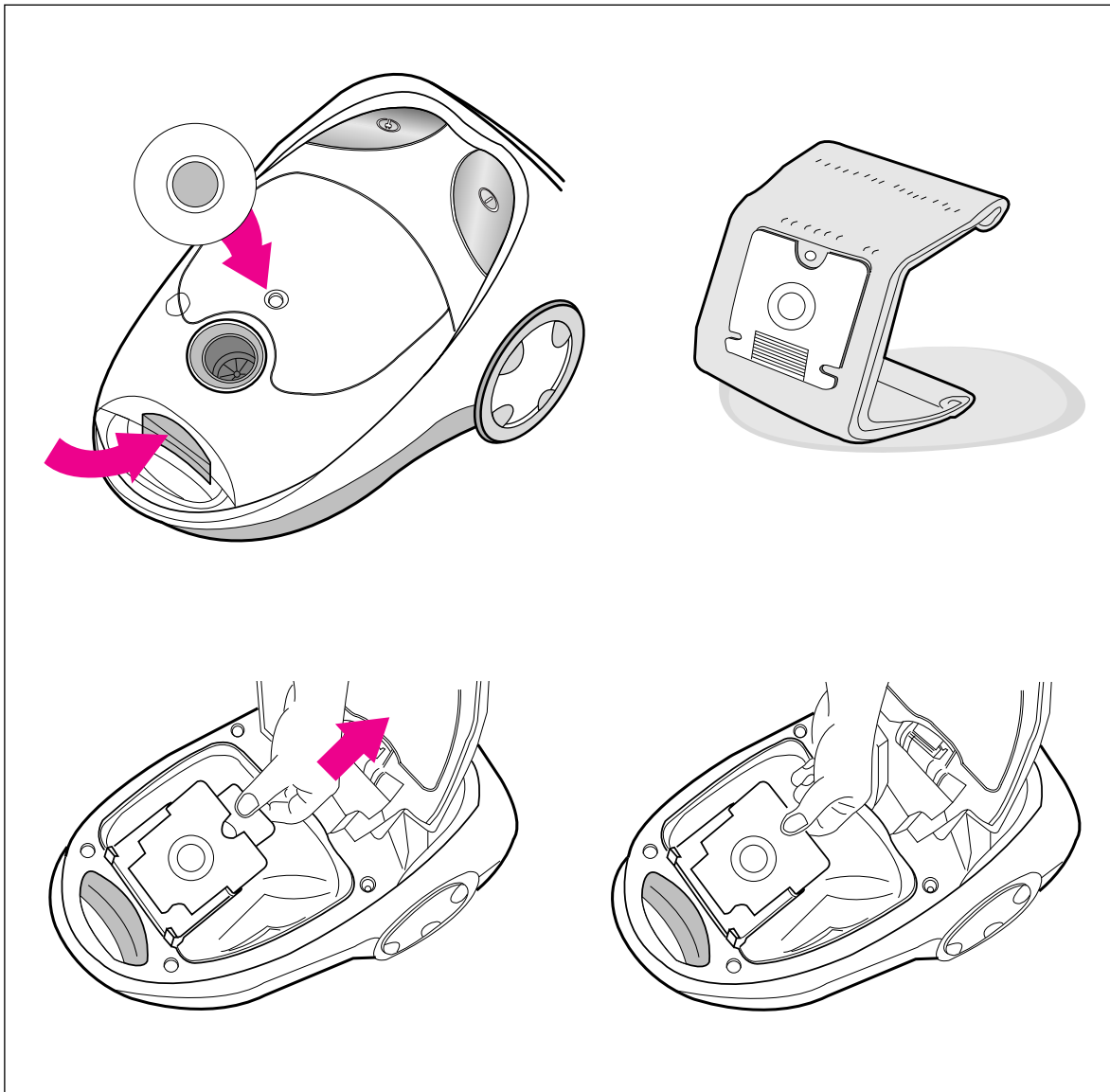

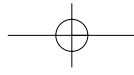

The Motor filter in the Dust bag compartment should be changed or washed when necessary. Wash the Motor filter with water and dry it out before using.

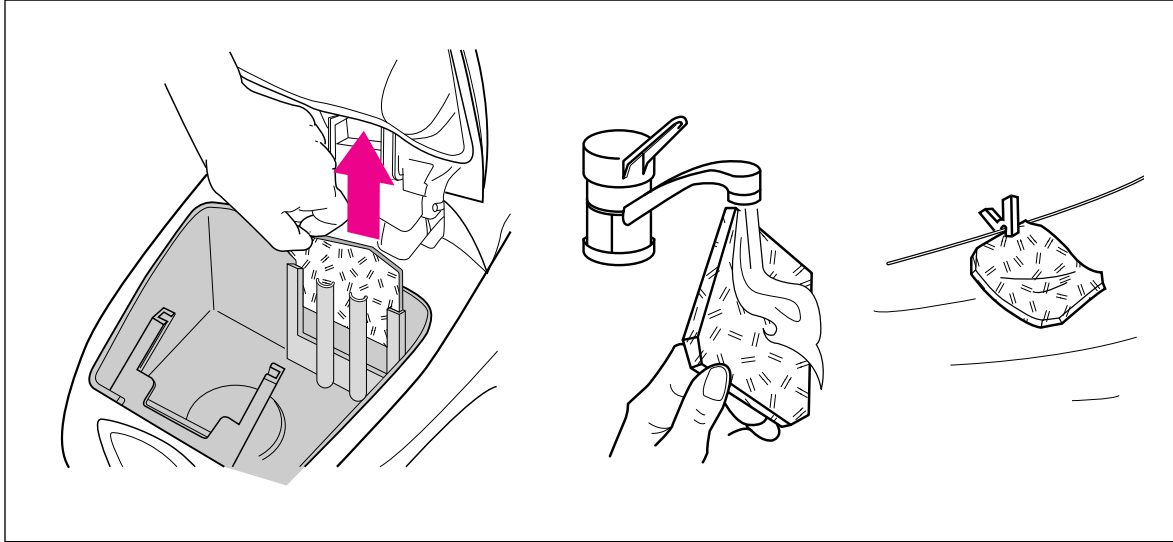

HEPA filter on the rear of the appliance is neither washable nor reusable when it gets dirt with dust. Put in a new filter unit when it is dirty.

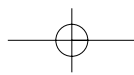
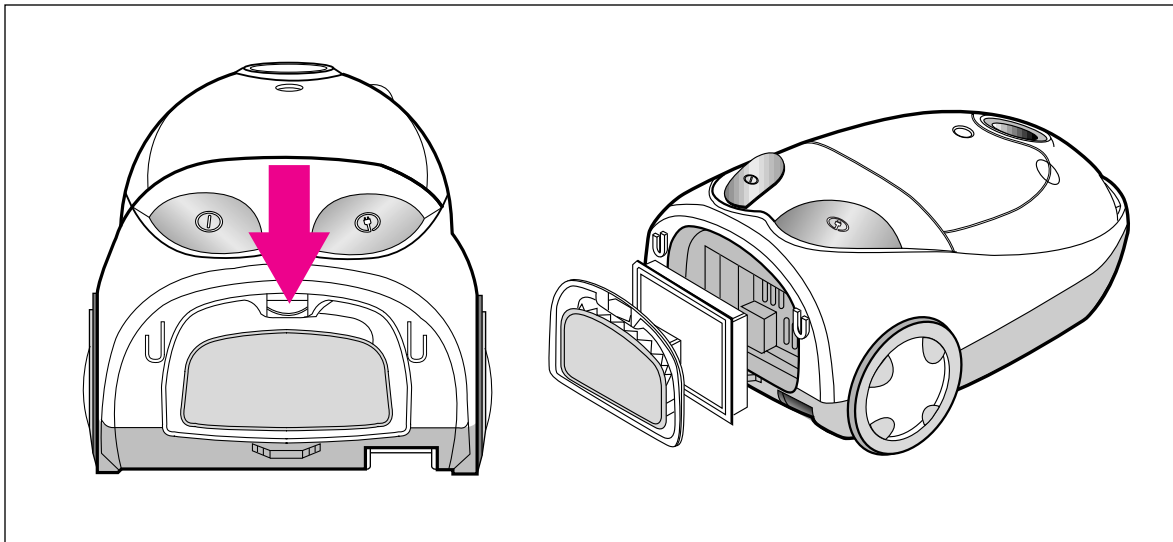

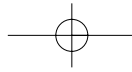

BEFORE ASKING FOR SERVICE

Please check each item below if you have trouble with your cleaner.
Before checking, ensure the cleaner is unplugged from the power supply.

PROBLEM	CHECK POINT	MEASURE
<ul style="list-style-type: none"> • Suction power is weak. 	<ul style="list-style-type: none"> • Filter bag • Hose 	<ul style="list-style-type: none"> • If it is filled with dust, change it. • If clogged or blocked, remove the object.
<ul style="list-style-type: none"> • The cleaner does not work. 	<ul style="list-style-type: none"> • Is the hose adapter inserted into the suction opening of the cleaner completely? 	<ul style="list-style-type: none"> • Insert it completely.
<ul style="list-style-type: none"> • Power cord does not rewind. • Power cord is not pulled out of the cleaner. 	<ul style="list-style-type: none"> • Power cord • Power cord 	<ul style="list-style-type: none"> • Pull the power cord out a little and press the cord rewind button. • Do not pull it by force Rewind it a little by pressing the cord rewind button and pull it out.

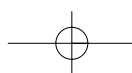

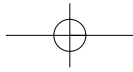

SPECIFICATIONS

Model	RC-700
Rating	230V/50Hz
Watts	Max. 1400W(1200W IEC)
Weight	5.2 kg
Dimension (B X H X T)	486 X 240 X 320 mm
Cord Length	6 m

