



Owner's Manual



# MARINE BLUETOOTH® HANDSET MR F300 BT

Nothing Comes Close to a Cobra®

English

Printed in China Part No. 480-463-P Version B Patent Pending

## Our Thanks to You and Customer Assistance

Introduction



### Our Thanks to You

Thank you for purchasing a CobraMarine *Bluetooth* Handset. Properly used, this Cobra product will give you many years of reliable service.

### How Your CobraMarine *Bluetooth* Handset Works

This handset allows use of mobile telephones (cell phones) afloat while protecting them from potential damage in the marine environment.

*Bluetooth* wireless technology allows voice and data transmission over short distances by means of a radio link. Using that technology, the *Bluetooth* handset allows your cell phone to be turned on and stowed in a waterproof and protected location on the vessel. Calls are then made and received using the *Bluetooth* handset on deck or in the cabin of your boat.



Customer Assistance

### Customer Assistance

Should you encounter any problems with this product, or not understand its many features, please refer to this owner's manual. If you require further assistance after reading this manual, Cobra Electronics offers the following customer assistance services:

#### For Assistance in the U.S.A.

**Automated Help Desk** English only.

24 hours a day, 7 days a week 773-889-3087 (phone).

**Customer Assistance Operators** English and Spanish.

8:00 a.m. to 6:00 p.m. Central Time Mon. through Fri. (except holidays)  
773-889-3087 (phone).

**Questions** English and Spanish.

Faxes can be received at 773-622-2269 (fax).

**Technical Assistance** English only.

www.cobra.com (on-line: Frequently Asked Questions).  
English and Spanish. productinfo@cobra.com (e-mail).

#### For Assistance Outside the U.S.A.

Contact Your Local Dealer or Visit [www.cobra.com](http://www.cobra.com).

©2008 Cobra Electronics Corporation  
6500 West Cortland Street  
Chicago, Illinois 60707 USA  
[www.cobra.com](http://www.cobra.com)

# Handset Controls and Indicators

Introduction

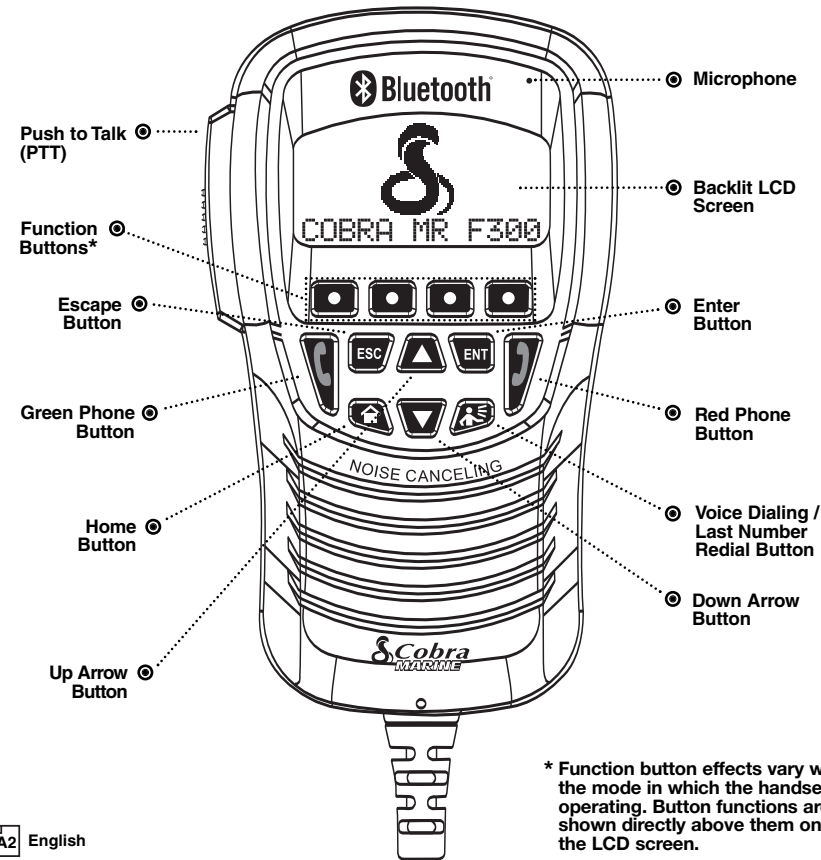
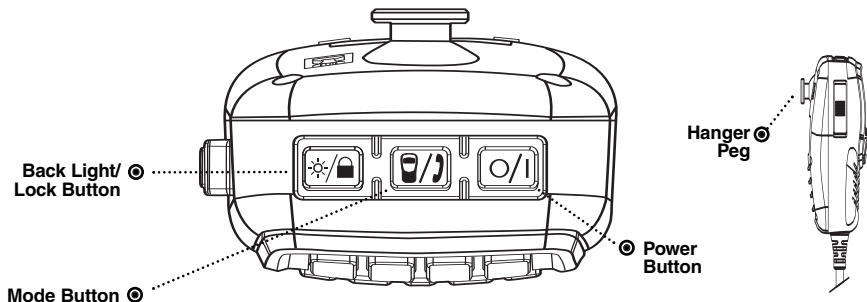

\* Function button effects vary with the mode in which the handset is operating. Button functions are shown directly above them on the LCD screen.

# Backlit LCD Screen, Product Features and Trademarks

Introduction



## Backlit LCD (Liquid Crystal Display) Screen

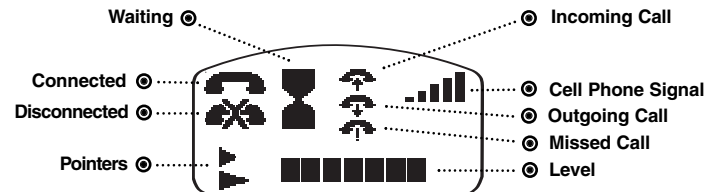

## Product Features

### Widely Compatible

Links with most *Bluetooth* enabled cell phones.

### Intuitive Operation

Handset is similar to CobraMarine radio microphones for easy operation.

### Submersible

Meets JIS7 submersible standards.

### Noise Cancelling Microphone

Reduces effect of environmental noise when speaking.

### External Audio Output

Allows connection of the F300 to your stereo's AUX input.

### Key Lock

Prevents accidental operation or setting changes when key lock is set.

### Backlit LCD Screen

Allows adjustment of brightness and contrast for legibility in all light conditions.

### Illuminated Buttons

Allows high visibility of all function buttons.

### Phonebook

Allows storage of name and number entries.

### Call Log

Displays data on the most recent calls including sent, received and missed.

## Trademark Acknowledgement

Cobra®, CobraMarine®, Nothing Comes Close to a Cobra® and the snake design are registered trademarks of Cobra Electronics Corporation, U.S.A.

Cobra Electronics Corporation™ and MicroBlue™ are trademarks of Cobra Electronics Corporation, U.S.A.

The Bluetooth® word mark and logo are registered trademarks owned by *Bluetooth* SIG, Inc., and any use of such marks by Cobra Electronics Corporation, U.S.A. is under license.

Other trademarks and trade names are the property of their respective owners.

# Table of Contents



## Introduction

|   |    |
|---|----|
| Our Thanks to You .....                           | A1 |
| Customer Assistance .....                         | A1 |
| Handset Controls and Indicators .....             | A2 |
| Backlit LCD (Liquid Crystal Display) Screen ..... | A3 |
| Product Features .....                            | A3 |
| Trademark Acknowledgement .....                   | A3 |
| Important Safety Information .....                | 2  |
| FCC Notice .....                                  | 2  |



## Installation

|                                |   |
|--------------------------------|---|
| Included in this Package ..... | 3 |
| Installation .....             | 4 |



## Operating Your Handset

|                                |    |
|--------------------------------|----|
| Getting Started .....          | 6  |
| Common MR F300 Functions ..... | 7  |
| Operation .....                | 11 |
| Customizing the MR F300 .....  | 16 |



## Warranty

|                |    |
|----------------|----|
| Warranty ..... | 23 |
|----------------|----|



## Product Service

|                       |    |
|-----------------------|----|
| Maintenance .....     | 24 |
| Product Service ..... | 24 |

## Important Safety Information

Before installing and using your *Bluetooth* handset, please read these general precautions and warnings.

### Warning and Notice Statements

To make the most of this *Bluetooth* handset, it must be installed and used properly. Please read the installation and operating instructions carefully before installing and using the handset. Special attention must be paid to the **WARNING** and **NOTICE** statements in this manual.



#### WARNING

Statements identify conditions that could result in personal injury or loss of life.



#### NOTICE

Statements identify conditions that could cause damage to the handset, other equipment or stored data.

### General Precautions

The following **NOTICES** information is important to your operation of the handset.



#### FCC NOTICES

This device complies with part 15 of the FCC Rules. Operation is subject to the following two (2) conditions:

1. This device may not cause harmful interference, and
2. This device must accept any interference received, including interference that may cause undesired operation.



#### NOTICES

**AVOID** using your *Bluetooth* handset at temperatures below -4°F (-20°C) or above 131°F (55°C).

**AVOID** storing your *Bluetooth* handset at temperatures below -4°F (-20°C) or above 158°F (70°C).

**DO NOT** attempt to service any internal parts yourself. Have any necessary service performed by a qualified technician.

The manufacturer is not responsible for any radio or TV interference caused by unauthorized modifications to this equipment. Such modifications could void the user's authority to operate the equipment.

## Recommendations for Marine Communication

The U.S. Coast Guard does not endorse cellular telephones as substitutes for marine radios. They generally cannot communicate with rescue vessels and, if you make a distress call on a cellular telephone, only the party you call will be able to hear you. Additionally, cellular telephones may have limited coverage over water and can be hard to locate. If you do not know where you are, the Coast Guard will have difficulty finding you if you are using a cellular telephone.

However, cellular telephones can have a place onboard where cellular coverage is available – to allow social conversations and keep the marine frequencies uncluttered and available for their intended use.

## Included in this Package

You should find all of the following items in the package with your CobraMarine *Bluetooth* handset.

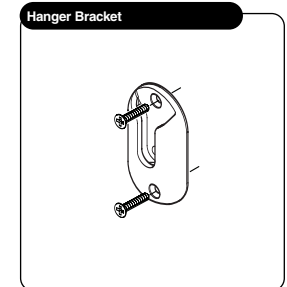
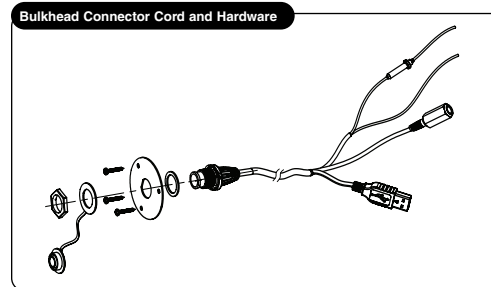
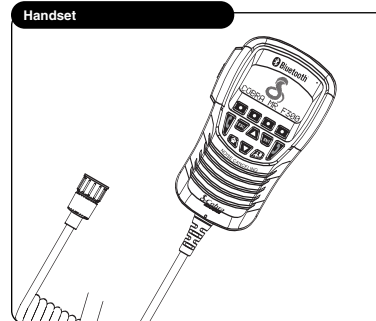

## Installation

Before using your *Bluetooth* handset, the bulkhead connector cord must be installed on your vessel and connected to a 12 volt DC power source.

### Installing the Bulkhead Connector Cord

Choose a convenient location for the connector near where the *Bluetooth* handset will be used. Keep in mind that the nine foot long coiled cord on the handset must be attached to the connector when the handset is to be used.

1. Drill a hole through the bulkhead or dash in the chosen location 7/8 inches for a thick dash or 5/8 inches for a thin dash.
2. Install the components as shown in the diagram.

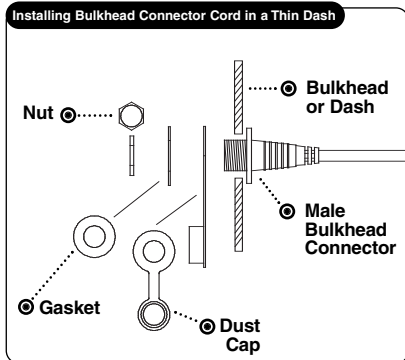
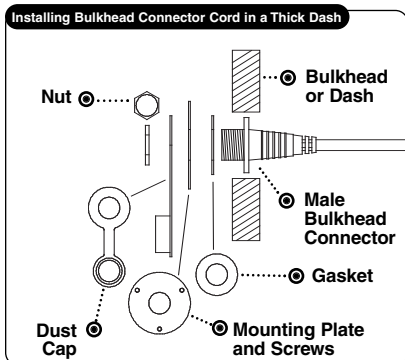

If the dash is thin enough, the flange can be at the back surface of the dash and the threads project out the front. If the dash is thick, the threaded part of the Male Bulkhead Connector will project through the Mounting Plate and the hole in the dash will be big enough for the flange at the base of the threads to be right up behind the Mounting Plate.

### Installing the Hanger Bracket

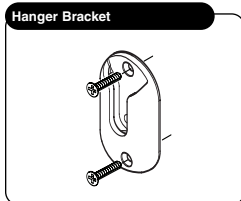

1. Install the hanger bracket on a vertical surface near the bulkhead connector using the supplied stainless steel screws.

## Connecting Power to the Bulkhead Connector Cord

Your *Bluetooth* handset is powered from your vessel's 13.8 volt DC system (12 volt nominal). A fused power connection lead is provided at the opposite end from the bulkhead connector fitting.

1. Attach the black wire to a negative ground.
2. Attach the fused red power wire to the positive side of the vessel's 12 volt DC power system.

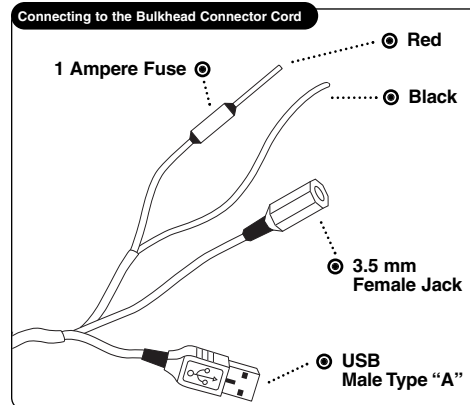

## Connecting (Optional) to a Stereo System AUX Input

Telephone conversations can be switched from the internal speaker in the *Bluetooth* handset to the speakers that are part of the boat's stereo system.

1. Connect the external stereo system to the handset connector cord with a 3.5 mm male stereo jack. This cable is not supplied but can be found at your local audio/visual store.

## USB Connector

The USB connector shown next to the external stereo jack is used to connect to a personal computer (PC) to reprogram or update the software in the *Bluetooth* handset. The latest software and update instructions can be found at [www.cobra.com](http://www.cobra.com).

## Getting Started

Refer to the foldout at the front of this manual to identify the various controls and indicators on your *Bluetooth* handset.

Most button functions are activated by a momentary press, then release. In those cases that call for “press and hold,” hold the button down for at least two seconds after it is pressed. The **PTT** button is held down as long as you are speaking into the microphone.

When using the handset, tones will sound to:

- Indicate an error – three beeps.
- Confirm an action – two beeps.
- Confirm a single button press (except the **PTT** button) – one beep.

You can turn the **Key Tones** Off if you want (see page 22).

### Try It Out

Using the *Bluetooth* handset is the most effective way to learn about it. Don't hesitate to explore functions and add entries to see how they work. Do not be concerned if you make mistakes. They can all be undone in **Edit** mode. Or you can reset the unit to the original factory default condition. Push and hold the **Green Phone** and **Home** function keys, then push the **Power** key until the unit turns On.



#### NOTICE

Resetting the unit will clear ALL *Bluetooth* device pairings as well as the Call Log, Phonebook and *Bluetooth* device list.

## Common MR F300 Functions

The following procedures define common operating functions of the handset.

### Power On/Off

Press the **Power** button at the top of the handset for two seconds to turn it On or Off.

The first time you turn On the CobraMarine *Bluetooth* handset you will see a message that the unit is ready for pairing with a cell phone. The message also provides a password. If you do not want to pair a device right away, press the **Escape** button to go to **Standby** mode.

When the unit is subsequently turned On, it will search for the currently selected *Bluetooth* device and go to **Standby** mode.

### Mode

This button serves two functions:

- To change the mode of operation between the *Bluetooth* handset and your cell phone itself.
- To switch voice activation of the microphone between On and Off. Turn VOX On if you want to operate in a hands-free mode similar to a *Bluetooth* handset.

### Mode

Normal operation of the CobraMarine *Bluetooth* handset uses its internal microphone and speaker to conduct conversations during a call. However, there may be times you want to suspend the *Bluetooth* pairing and continue part or all of the call on your cell phone itself.

#### To Change Between Handset and Cell Phone Modes:

1. Press the **Mode** button to switch the call to your cell phone.
2. Talk and listen to your cell phone in the usual way. The handset will be inactive.
3. Press the **Mode** button to restore operation to the handset.
4. Talk and listen to the call on the *Bluetooth* handset.

### VOX

The **VOX** function converts the handset microphone's pickup of your voice from being controlled by the **PTT** button to being activated by your voice. When **VOX** is On, the **PTT** button does not need to be pushed to transmit your voice and you can just speak into the microphone.

When **VOX** is Off, you need to push the **PTT** button while speaking.

#### To Change Between VOX On and Off:

1. Press and hold the **Mode** button for two seconds while a call is in progress.



#### NOTE

When the **VOX** function is On in noisy environments, the caller connected to the F300 might hear some of your background noise.

### Back Light/Lock

This button serves two functions:

- To turn the display back light On and Off.
- To lock and unlock most of the buttons on the handset.

#### Back Light

A light is provided behind the LCD screen to improve visibility of the information provided there. However, you can turn the light On or Off at will.

#### To Turn the Back Light On or Off:

1. Press the **Back Light/Lock** button.

#### Lock

The **Lock** function disables the operation of all buttons except **PTT**, **Back Light/Lock** and **Power** buttons. When **Lock** is On, accidental presses of any of the other buttons are ignored by the unit. A call can be continued if it was started before **Lock** was turned On, but new calls cannot be made or answered when **Lock** is On.

#### To Turn Lock On or Off:

1. Press and hold the **Back Light/Lock** button for two seconds.

### Push to Talk (PTT)

This button serves two functions:

- To activate the handset microphone during a call when **VOX** is Off. This is similar to the action of such a button on a CobraMarine VHF or a CB radio.
- To activate the handset microphone for a **PA** announcement, the unit must be in **Standby** and be connected to the stereo's AUX input with the stereo in **AUX** mode.

#### To Activate the Handset Microphone During a Call:

1. After placing or accepting a call, press the **PTT** button and talk into the handset microphone.

#### To Make a PA Announcement:

1. When the unit is in **Standby** mode, press the **PTT** button and talk into the microphone.



#### NOTE

Before a PA announcement can be made:

- The **PA function** must be turned ON from the settings menu.
- The F300 must be connected to the stereo system AUX input.
- The stereo must be in **AUX** mode with the stereo's volume adjusted.

### Green Phone Button

This button acts just like the green phone button on a cell phone. Pressing the button answers an incoming call and initiates dialing an outbound call after the number has been entered or selected.

In **Standby** mode, this button is a shortcut to the **Call Log** where a number can be selected to call.

### Red Phone Button

This button acts just like the red phone button on a cell phone. Pressing the button ends an active call.

In modes other than an active call, it backs up to the **Standby** mode.

## Home Button

Pressing this button enables you to return the handset to **Standby** mode from any other mode.

## Voice Dialing / Last Number Redial

This button serves two functions:

- To enable voice dialing.
- To redial the last number dialed from the handset.

### Voice Dialing

You can activate your cell phone's voice dialing feature from **Standby** mode.

#### To Voice Dial A Number:

1. Press and release the **Voice Dialing / Last Number Redial** button.
2. Say the name or phone number command following the audio prompt.

The display screen will show the progress of dialing and connecting the call.



#### NOTE

Your cell phone must have voice dialing enabled and voice commands recorded to use this feature with the F300.

#### To Redial The Last Number Dialed:

1. Press and hold the **Voice Dialing / Last Number Redial** button for two seconds. The display screen will show the progress of dialing and connecting the call.

## Function Buttons

The **Function** buttons provide different utilities to different modes of handset operation. In any mode, the active functions are shown directly above the buttons on the display screen as shown in this **Standby** display.

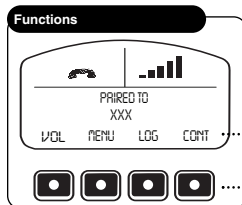

In this example, pressing the second button from the left will display the **Menu**.

● **Function Names**

● **Function Buttons**

## Operation

Once the CobraMarine *Bluetooth* handset has been paired with a cell phone, incoming calls can be answered and outgoing calls can be made.

### Standby

While waiting to receive or make a call, the handset will be in **Standby** mode.

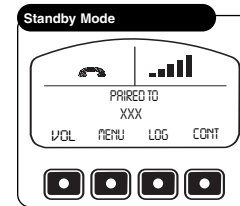

The upper part of the screen shows the **Waiting For A Call** icon and the cell phone signal strength.

The **Function** buttons (from left to right) will activate display of the **Volume** screen, the **Menu** screen, the **Call Log** screen and the **Phonebook** screen.

The **Up** and **Down Arrow** buttons will also adjust handset speaker volume directly while in **Standby** or during a call.

### Incoming Call

When the active paired cell phone receives a call, the ring tone will sound and it will be announced on the handset screen.

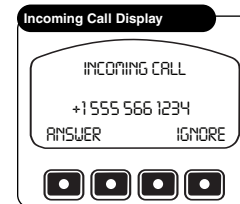

### Ringing

The call can be answered by pressing either the **Answer Function** button or the **Green Phone** button.

If the **Ignore Function** button is pressed, the call will not be accepted, but will be recorded in the **Call Log**.

### Answered Call

The **Mute Function** button will disable the microphone, but allow you to continue to hear the calling person.

To end the call and return to **Standby** mode, press either the **End Function** button or the **Red Phone** button.

Caller information like name and number of the incoming caller will only be shown if it is available on your network and/or device.

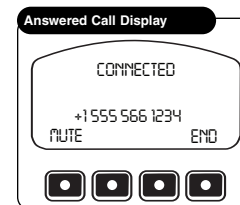



## Call Waiting

When a second call rings during an active call, it will be announced on the handset screen.

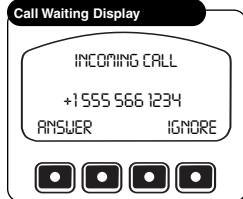

### To Answer the Waiting Call:

1. Press the **Answer Function** button. The waiting call will become active, the first call will be put on hold.

## Outgoing Call

Outgoing calls can be initiated in three ways:

- By selecting a **Phonebook** entry.
- By selecting a **Call Log** entry.
- By dialing the number using handset **Function** buttons.

### Phonebook

After adding a number to your **Phonebook**, you can go to the **Phonebook** and select it from the available numbers to be dialed.

To access a number in the **Phonebook**, press the **Menu Function** button in **Standby** mode, then select the **Phonebook** mode to arrive at the screen shown.

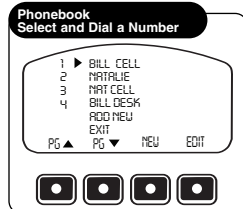

### To Select and Dial a Number:

1. Use the **Page Up** and **Page Down** buttons to shift up and down the list of entries.
2. Use the **Up** and **Down Arrow** buttons to scroll the pointer at the left of the screen to the desired entry.
3. Press the **Green Phone** button to call the number.

## Call Log

The most recent incoming and outgoing calls are recorded in the handset **Call Log**. These can be used to select and dial a number.

To access a number in the **Call Log**, press the **Menu Function** button in **Standby** mode, then select the **Call Log** mode to arrive at the screen shown.

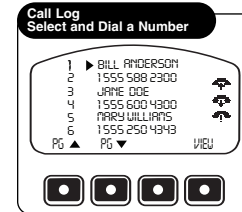

### To Select and Dial a Number:

1. Use the **Page Up** and **Page Down** buttons to shift up and down the list of entries.
2. Use the **Up** and **Down Arrow** buttons to scroll the pointer at the left of the screen to the desired entry.
3. Press the **Green Phone** button to call the number.



### NOTE

While in **Call Log** mode, you can see details of the selected entry by pressing the **View Function** button or **Enter** button.

## Dial Number

To enter a number you want to dial, press the **Menu Function** button in **Standby** mode, then select the **Dial By Number** mode to arrive at the screen shown.

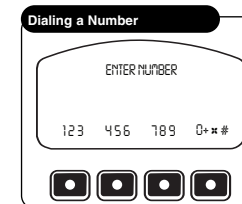

### To Enter a Number to be Dialed:

1. Press and release the **Function** button under the first digit of the phone number until the correct number appears above the flashing cursor.
2. Wait for the cursor to shift to the right or press the **Enter** button to shift the cursor.
3. Enter the second digit of the phone number as in step 1.
4. Repeat steps 1 and 2 until the complete number has been entered.
5. Press the **Green Phone** button to call the number.



### NOTE

The number will appear on the screen without dashes or other separators.

## Bluetooth Phone Setup and Switching

The CobraMarine *Bluetooth* handset can be paired with only one device at a time. However, it can store pairing information on up to eight different devices.

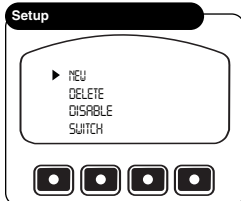

### To Begin Phone Setup or To Switch To Pair With a Different Device:

1. Press the **Menu** button in **Standby** mode, then select the **Bluetooth Phone Setup** mode to arrive at the screen shown.
2. At this screen, use the **Up** and **Down Arrow** buttons to move the pointer to the desired function. Then press the **Enter** button to select the function and advance to its screen.

### New

New can be used to add a device to those already paired or to pair a device if you did not do so at the initial Power On of the F300.

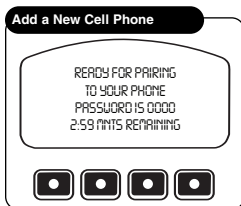

### To Add a New Cell Phone:

1. Select **New** on the **Phone Setup** screen to advance to the screen shown.
2. Follow the cell phone's instructions to search for available pairing with another *Bluetooth* device. This can often be found in the Tools or Settings menu of your mobile phone.
3. Wait for the pairing process to complete.

You will then see a confirmation of successful pairing or a notice to try again if pairing did not occur.

The newly paired cell phone will become the active one that is used for calls until you Switch to another.

### Delete

Delete is used to remove the pairing information for a device from the handset memory.

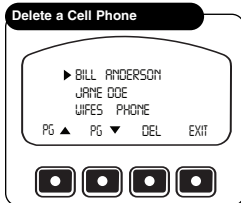

### To Delete a Cell Phone:

1. Select **Delete** on the **Phone Setup** screen to advance to the screen shown.
2. Use the **Page Up** and **Page Down** buttons to shift up and down the list of entries three items at a time.
3. Use the **Up** and **Down Arrow** buttons to scroll the pointer at the left to the screen to the desired entry.
4. Press the **Delete Function** button to remove the device from the list.

## Disable

Disable prevents pairing with a device, but does not remove it from the list or its pairing data from the handset memory.

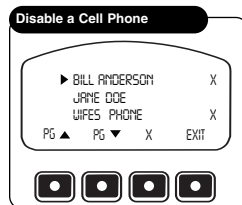

### To Disable a Cell Phone:

1. Select **Disable** on the **Phone Setup** screen to advance to the screen shown.
2. Use the **Page Up** and **Page Down** buttons to shift up and down the list of entries three items at a time.
3. Use the **Up** and **Down Arrow** buttons to scroll the pointer at the left to the screen to the desired entry.
4. Press the **X Function** button to disable an available device or to enable a disabled device.

An **X** at the right of an entry indicates that it is in disabled status.

## Switch

The **Switch** function allows you to select which device will be used for calls from the list of those available.

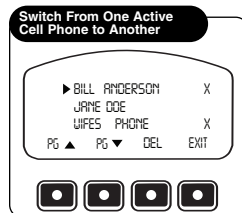

### To Switch From One Active Cell Phone to Another:

1. Select **Switch** on the **Phone Setup** screen to advance to the screen shown.
2. Use the **Page Up** and **Page Down** buttons to shift up and down the list of entries three items at a time.
3. Use the **Up** and **Down Arrow** buttons to scroll the pointer at the left of the screen to the cell phone which you want to make active.
4. Press the **Enter** button to begin the process of re-pairing to the selected device.

## Customizing the MR F300

Your CobraMarine *Bluetooth* handset allows you to customize its operation to match your preferences. Features you can adjust have the following defaults when the unit is new or after a reset:

- **VOX:** Off
- **PA Output:** Off
- **Display Brightness:** high
- **Ring Tone:** #1
- **Call Log:** cleared
- **BT Device List:** cleared
- **Display Contrast:** 8
- **Button Tones:** On
- **Phonebook:** cleared
- **Volume:** 75%
- **Auto Dim:** Off
- **BT Region:** USA and EUROPE

## Menu

The customizable features on your handset are reached from the **Menu** mode.

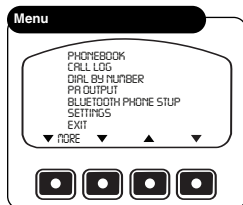

To begin customizing your handset, press the **Menu Function** button in **Standby** mode to arrive at the screen shown.

The **Menu** options list appears on the screen.

The complete list is:

- Phonebook
- Dial By Number
- *Bluetooth* Phone Setup
- Exit
- Call Log
- PA Output
- Settings

You can scroll through the list one entry at a time by use of the **Up** and **Down Arrow** buttons.

Once the pointer at the left of the screen is positioned at the option you want, press the **Enter** button to select it and advance to its screen.

## Phonebook Entries

The Operation section described using a **Phonebook** entry to dial an outgoing call. Both names and numbers can be stored in the **Phonebook**.

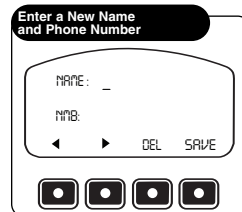
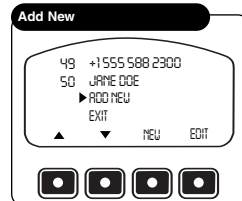

### To Enter a New Name and Phone Number

1. Select **Phonebook** from the **Menu** function and scroll the pointer down to **Add New** at the bottom of the list to arrive at the screen shown.
2. Press the **Enter** or **New Function** button to advance to the **Phonebook Edit** mode.
3. Press the **Up** or **Down Arrow** button to scroll the alphanumeric list to the first character of the **Name**.



### NOTE

The list consists of the letters A to Z followed by the numbers 0 to 9 followed by +, "space," \*, and # and it will wrap around from # to A.



### NOTE

If only a number (without a name) is to be entered, at step 3, press the **Right Arrow Function** button until the cursor moves to the first character of the number and jump to step 7.

4. When the first character appears above the cursor, press the **Enter** or **PTT** button to save the character and move the blinking cursor to the right.
5. Repeat step 4 until the entire name has been entered.
6. Continually press or press and hold the **Right Arrow Function** button until the cursor moves to the first character of the Number.
7. Enter the phone number in the same fashion as the name.
8. Press the **Save Function** button to save the entry and go back to the **Phonebook** function.

## NOTE

If corrections are needed before saving the entry, press the **Left** or **Right Arrow Function** button to move the cursor to the character that is to be changed and press the **Delete Function** button to remove that character. Then scroll the list to select the correct character.

## NOTE

A “double click” on the **Delete Function** button will remove the entire entry and return the cursor to the initial position after **Name**.

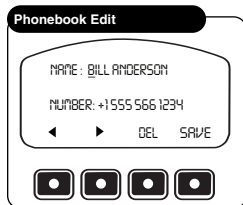

### To Edit an Existing Name or Phone Number:

1. Select **Phonebook** from the **Menu** function, scroll down to name or number to be edited and press the **Edit Function** button to arrive at the screen shown.
2. Use the **Right** and **Left Arrow Function** buttons to move the cursor to the character(s) to be changed and proceed as described for making corrections when entering a new name or number.
3. Press the **Save Function** button to save the changes or deletion and go back to the **Phonebook** function.

## PA Output

If, during installation, you have connected the CobraMarine *Bluetooth* handset connection cable to your vessel's stereo AUX input, you can allow the handset to be used as a public address microphone.

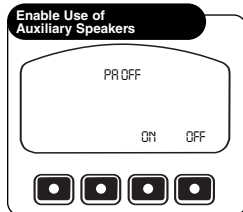

### To Enable Use of Auxiliary Speakers:

1. Select **PA Output** from the **Menu** function to arrive at the screen shown.
2. Press the **On** or **Off Function** button to toggle between On and Off condition.

## Settings

The **Settings** option on the **Menu** provides access to the remaining functions needed to customize your handset.

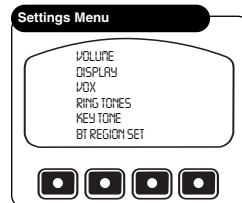

To access these functions, select the **Settings** option from the **Menu** to arrive at the screen shown.

The **Settings** options list appears on the screen.

The complete list is:

- Volume
- VOX
- Key Tones
- Exit
- Display
- Ring Tones
- BT Region

Once the pointer at the left of the screen is positioned at the option you want, press the **Enter** button to select it and advance to its screen.

## Volume

This volume adjustment can be performed on the internal speaker in the handset either from **Standby** mode or during a call.

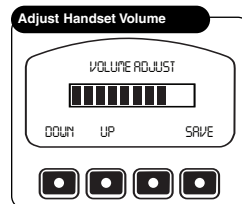

### To Adjust the Handset Volume:

1. Select **Volume** from the **Settings** function to arrive at the screen shown.
2. Press the **Up** or **Down Arrow** buttons or the **Up** or **Down Function** buttons to adjust the speaker volume. The bar graph will show the level you have set.
3. Press the **Enter** or **Save Function** button to save the volume setting and return to **Settings** function.

## Display

The **Display** function adjusts the lighting of the LCD screen and includes three separate adjustments: Brightness, Contrast and Auto Dim.

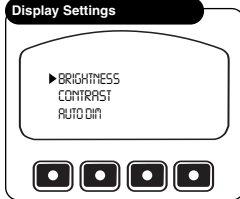

To access these functions, select the **Display** option from **Settings** mode to arrive at the screen shown.

You can scroll the list using the **Up** and **Down Arrow** buttons.

Once the pointer at the left of the screen is positioned at the option you want, press the **Enter** button to select it and advance to its screen.

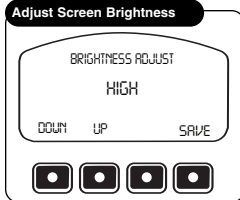

### To Adjust the Screen Brightness:

1. Select **Brightness** from the **Display** mode to advance to the screen shown.
2. Press the **Up** or **Down Arrow** or **Up** or **Down Function** button to step through the available settings of High, Medium, Low and Off.
3. At the desired setting, press the **Enter** or **Save Function** button to save the setting and return to **Display** function.

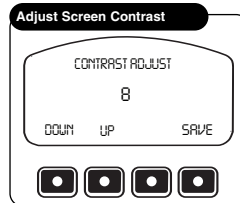

### To Adjust the Screen Contrast:

1. Select **Contrast** from the **Display** mode to advance to the screen shown.
2. Press the **Up** or **Down Arrow** or **Up** or **Down Function** button to step through the available settings. The range is from a minimum at 0 to a maximum at 16.
3. At the desired setting, press the **Enter** or **Save Function** button to save the setting and return to **Display** function.

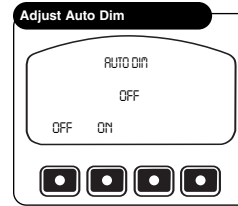

### To Set Auto Dim On or Off:

1. Select **Auto Dim** from the **Display** mode to advance to the screen shown.
2. Press the **Off** or **On Function** button to select the desired condition.
3. Press the **Enter** button to save the setting and return to **Display** mode.



#### NOTE

When **Auto Dim** is set to On, the LCD screen backlight will be turned Off after 15 seconds if no button is pressed. It will be turned On for 15 seconds following any button press except **PTT**.

## VOX

The **VOX** function can be turned **On** or **Off** directly with the **Mode** button as described on page 8 or from the **Menu**.

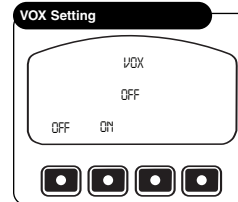

### To Set VOX On or Off from the Menu:

1. Select **VOX** from **Settings** mode to advance to the screen shown.
2. Press the **Off** or **On Function** button to select the desired condition.
3. Press the **Enter** button to save the setting and return to **Settings** mode.



#### NOTE

The **VOX On** or **Off** setting will be retained when the unit is turned **Off**.

## Ring Tones

Ten different ring tones are available from which to choose.

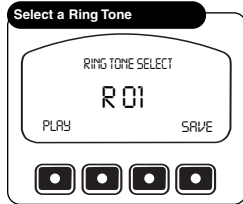

### To Select a Ring Tone:

1. Select **Ring Tones** from **Settings** mode to advance to the screen shown.
2. Press the **Up Arrow** or **Down Arrow** button to scroll through the tones from 01 to 10.
3. Press the **Play Function** button to hear the selected tone.
4. Press the **Enter** or **Save Function** button to save the tone and return to **Settings** mode.

## Key Tones

Key tones confirm button presses for all but the **PTT** button.

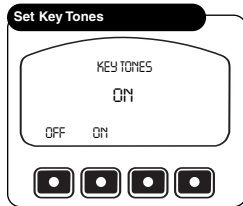

### To Set Key Tones On or Off:

1. Select **Key Tones** from **Settings** mode to advance to the screen shown.
2. Press the **Off** or **On Function** button to select the desired condition.
3. Press the **Enter** or **PTT** button to save the setting and return to **Settings** mode.

## Bluetooth Region

Different parts of the world use different sets of radio frequencies for *Bluetooth* pairing. You can select from four regions for handset operation: (1) USA - Europe, (2) France, (3) Spain and (4) Japan. Most users will not need to change these settings.

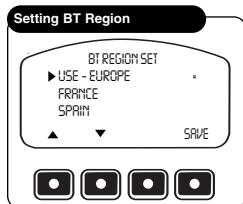

### To Select A Bluetooth Region:

1. Select **BT Region** from the **Settings** function to arrive at the screen shown.
2. Press the **Up** or **Down Arrow** buttons or the **Up** or **Down Function** buttons to scroll through the list.
3. Once the pointer at the left of the screen is positioned at the region you want, press the **Enter**, **PTT** or **Save Function** button to save the setting.

## Limited 3-Year Warranty

### For Products Purchased In The U.S.A.

Cobra Electronics Corporation warrants that its CobraMarine *Bluetooth* handset, and the component parts thereof, will be free of defects in workmanship and materials for a period of three years from the date of first consumer purchase. This warranty may be enforced by the first consumer purchaser, provided that the product is used within the U.S.A.

Cobra will, without charge, repair or replace, at its option, defective handsets, products or component parts upon delivery to the Cobra Factory Service department, accompanied by proof of the date of first consumer purchase, such as a duplicated copy of a sales receipt.

You must pay any initial shipping charges required to ship the product for warranty service, but the return charges will be at Cobra's expense, if the product is repaired or replaced under warranty. This warranty gives you specific legal rights, and you may also have other rights which may vary from state to state.

### Exclusions. This limited warranty does not apply:

1. To any product damaged by accident.
2. In the event of misuse or abuse of the product, or as a result of unauthorized alterations or repairs.
3. If the serial number has been altered, defaced or removed.
4. If the owner of the product resides outside the U.S.A.

All implied warranties, including warranties of merchantability and fitness for a particular purpose are limited in duration to the length of this warranty. Cobra shall not be liable for any incidental, consequential or other damages; including, without limitation, damages resulting from loss of use or cost of installation.

Some states do not allow limitations on how long an implied warranty lasts and/or do not allow the exclusion or limitation of incidental or consequential damages, so the above limitations may not apply to you.

### For Products Purchased Outside The U.S.A.

Please contact your local dealer for warranty information or visit [www.cobra.com](http://www.cobra.com).



## Maintenance

Very little maintenance is required to keep your CobraMarine *Bluetooth* handset in good operating condition:

- Keep the handset clean by wiping with a soft cloth and mild detergent. Do not use solvents or harsh or abrasive cleaners, which could damage the case or scratch the LCD screen.
- If the handset is exposed to salt water, wipe with a soft, moist cloth at least once a day to prevent buildup of salt deposits, which could interfere with button operation.
- To determine the software version in your handset, press and hold the PTT button while turning On the power. The version number will show on the LCD screen for five seconds, then proceed to normal startup.
- The USB connector on the bulkhead connector cord can be used to update the software for your handset using a personal computer. Go to Cobra's website [www.cobra.com](http://www.cobra.com) to find the latest software version and follow the instructions there.

## Product Service

For any questions about operating or installing this new Cobra product, or if parts are missing...**PLEASE CALL COBRA FIRST**...do not return this product to the store.

If this product should require factory service, please call Cobra first before sending the product. This will ensure the fastest turnaround time on any repair. If Cobra asks that the product be sent to its factory, the following must be furnished to have the product serviced and returned:

1. For Warranty Repair include some form of proof-of-purchase, such as a mechanical reproduction or carbon of a sales receipt. Make sure the date of purchase and product model number are clearly readable. If the originals are sent, they cannot be returned.
2. Send the entire product.
3. Enclose a description of what is happening with the product. Include a typed or clearly printed name and address of where the product is to be returned, with phone number (required for shipment).
4. Pack the product securely to prevent damage in transit. If possible, use the original packing material.
5. Ship prepaid and insured by way of a traceable carrier such as United Parcel Service (UPS) or Priority Mail to avoid loss in transit to:  
Cobra Factory Service, Cobra Electronics Corporation  
6500 West Cortland Street, Chicago, Illinois 60707 U.S.A.
6. If the product is in warranty, upon receipt of the product, it will either be repaired or exchanged depending on the model. Please allow approximately 3 – 4 weeks before contacting Cobra for status. If the product is out of warranty, a letter will automatically be sent with information as to the repair charge or replacement charge.

**For any questions, please call 773-889-3087 for assistance.**