

The illustration shows RR-US470.

Dear customer

Thank you for purchasing this product.

For optimum performance and safety, please read these instructions carefully.

Before connecting, operating or adjusting this product, please read the instructions completely. Please keep this manual for future reference.



Panasonic®

Operating Instructions IC Recorder

Model No. **RR-US490**
RR-US470
RR-US450
RR-US430

If you have any questions contact

In the U.S.A.: 1-800-211-PANA(7262)

In Canada: 1-800-561-5505

For U.S.A. only

**The warranty can be found
on pages 40 and 41.**

For Canada only

**The warranty can be found
on pages 42 and 43.**

RQT8824-MP

Instruction flow chart

Instruction flow chart

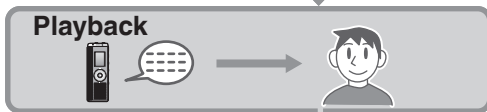
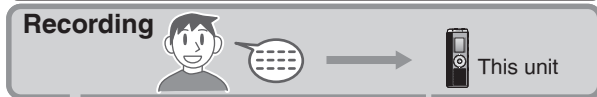

Connecting IC Recorder to a computer for editing/saving

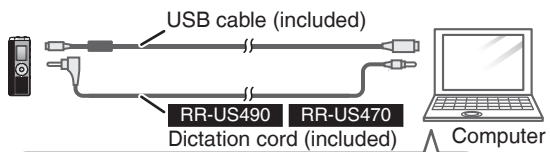

- Playback voice recording on computer
- Save on computer (backup)
- Edit voice recording etc.

The correct instruction manual you should refer to

For IC Recorder operation...
For instructions on connecting IC Recorder to a computer, installing instructions etc...

These Operating Instructions

For Voice Editing instructions...

Voice Editing Ver. 2.0 Operating Instructions (PDF file)

Table of contents

Preparation	
Instruction flow chart	2
Supplied accessories	4
Inserting batteries	4
Before use	5
Point 1 Before operating, switch Hold off, when finished, switch Hold on	5
Point 2 Recordings become audio files and the files are stored in folders	6
Point 3 Choose a recording method that best suits the situation	7
Part names	8
How to use the quick search dial	9
List of menus	10
Setting the time	11
Canceling the operation beep	11
Basic use	
Recording	12
Meeting recording	12
Display during recording	12
Dictation recording	13
Stop and pause	13
Confirming the remaining time	13
Other recording methods	14
Zoom recording (recording target voice clearly)	14
Recording through an external microphone	14
Listening to the recording in progress	14
Preventing unnecessary recording (VAS)	15
Timer recording	15

Playing	16
While a file is being played	
● Adjusting the volume	16
● Moving forward/moving backward	16
● Making recorded sounds easier to catch (reducing noise) ...	16
Other playing methods	17
Searching points for listening (fast forward and fast backward)	17
Changing the playback speed	17
Playing files successively	18
Listening with earphones	18
Advanced use	
Organizing files	19
Deleting	19
Moving	19
Lock (file protection)	19
Security functions	20
Security functions of this unit	20
Folder S and password	20
Setting the password	20
Playback using the password	21
When you forget the password	21
Recording to / from a cassette tape	22
Reference	
Using the unit with a computer	23
Troubleshooting guide	30
Specifications	33
Maintenance	34
Care and use	35
Product service	38
Limited Warranty (ONLY FOR U.S.A.)	40
Limited Warranty (ONLY FOR CANADA)	42

Supplied accessories



Please check and identify the supplied accessories.

Use numbers indicated in parentheses when asking for replacement parts. (Product numbers correct as of March 2008. These may be subject to change.)

- RR-US490** : 2
 - For the U.S.A.** **RR-US470** **RR-US450** : 1
 - For Canada** **RR-US470** **RR-US450** : 2CD-ROM (Voice Editing Ver.2.0 Premium Edition)
- RR-US430** : 1
CD-ROM (Voice Editing Ver.2.0 Standard Edition)
- RR-US490** **RR-US470** : 1
Dictation cord [K2KC2CB00001]
- All models** : 1
USB cable [K2KZ4CB00012]

Only for the U.S.A.: To order accessories, refer to "Accessory Purchases" (→ page 41).

Only for Canada: To order accessories, call the dealer from whom you have made your purchase.

Inserting batteries

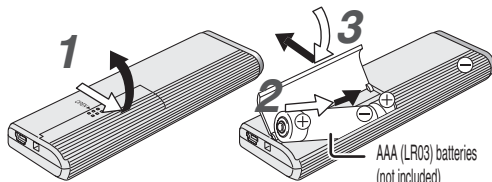

Make sure the batteries face the right directions.

- Replace the batteries within 30 seconds to preserve the settings. (Recordings remain intact.)
- The clock, however, will stop until the batteries have been inserted.
- If rechargeable batteries are to be used, rechargeable batteries manufactured by Panasonic are recommended.
- When batteries are inserted, "2008" or "2007" flashes on the display. Set Hold off (→ page 5) and set the time (→ page 11).

The battery indicator

(Displayed during recording/playback)



Replace the batteries.

"⚡" indicates flashing.

- When "⚡" is displayed, replace the batteries.

Before use

Point 1

Before operating,
switch Hold off,
when finished,
switch Hold on.

Remove the seal from
the display before use.

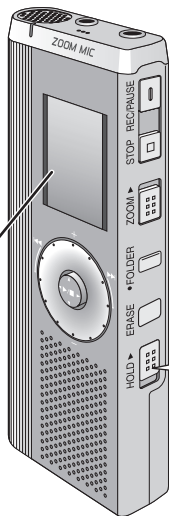

**Hold
(Slide up)**
↕
**Hold off
(Slide down)**

Hold function

- This function prevents accidental operation when you put the unit in your pocket or bag. It also prevents battery loss from accidental unit operation.

When you set Hold on

- Button operations are ignored even if you press buttons by mistake.
- When you set Hold on while recording or playing, “hold” appears for 2 seconds and the recording or playing display reappears.
- When you set Hold on while the unit is stopped, “hold” appears for 2 seconds and the display turns off.

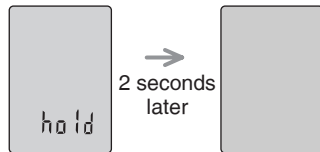

This unit has no power button.

- You can make batteries last longer by setting Hold on and turning the display off.

Before use

Point 2

Recordings become audio files and the files are stored in folders.

A new audio file is created each time you record.

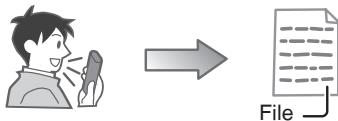

The created file is stored in a folder.

MEETING FOLDERS (A, B, C and S)

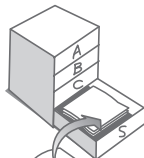

DICTATION FOLDER (M)

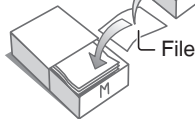

- A maximum of 99 files can be stored in each folder.
- Remaining recording time (→ page 13) may become shorter than periods listed in this table.

Approximate total recording time of all folders

Model	RR-US490	RR-US470	RR-US450	RR-US430
Recording mode				
HQ (High quality)	79 hours 10 minutes	39 hours	19 hours 10 minutes	9 hours 40 minutes
FQ (Fine quality)	158 hours 30 minutes	78 hours 10 minutes	38 hours 30 minutes	19 hours 30 minutes
SP (Standard play)	271 hours 30 minutes	134 hours	66 hours	33 hours 20 minutes

Point 3

Choose a recording method that best suits the situation.

MEETING RECORDING

Using different combinations of recording modes and microphone sensitivity levels, you can adjust audio quality according to recording situations. Using the zoom function, you can also record target voice clearly (→ page 14).



To record a low-level sound source...

- Place the unit on a desk etc. closer to the source.
- Use "L" microphone sensitivity for close proximity hand-held recording.

Meeting recording settings (no zoom recording for RR-US430)

Microphone sensitivity		H (Far)	L (Near)
Zoom recording	[OFF]	A normal meeting	A meeting held in a small room
	[ON]	A lesson, lecture	An interview during a meeting
Recording mode		HQ (high quality)/ FQ (fine quality)/ SP (standard play)	

DICTATION RECORDING



As the dictation recording settings are all factory-set, dictation can be recorded quickly and simply. Use this mode when computer voice recognition software is to be used.

Dictation recording settings

Microphone sensitivity	Dictation Recording level (fixed)
Recording mode	HQ (high quality) (fixed)

Part names

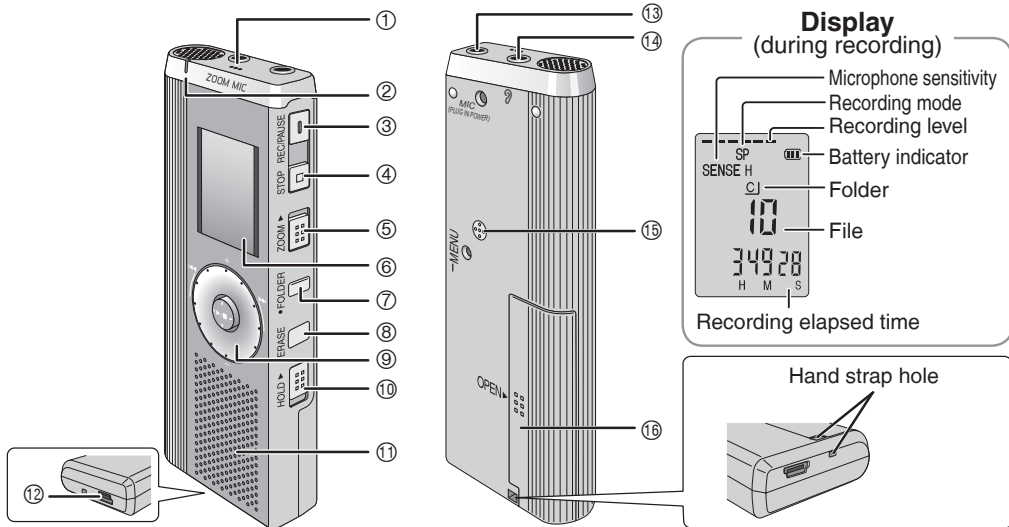

Display

(during recording)

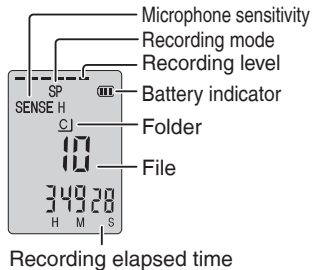

Recording elapsed time

Hand strap hole

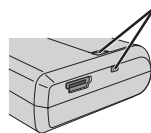

- ① Built-in microphone
- ② Recording indicator
- ③ Record/ pause
- ④ Stop
- ⑤ Zoom **Not on RR-US430**

- ⑥ Display
- ⑦ Folder/menu
- ⑧ Erase
- ⑨ Quick search dial
- ⑩ Hold

- ⑪ Speaker
- ⑫ USB jack
- ⑬ External microphone jack

- ⑭ Headphone/ earphone jack
- ⑮ Zoom microphone (dented area) **Not on RR-US430**
- ⑯ Battery cover

How to use the quick search dial

Basic operations

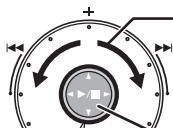

Ⓐ: Dial:
Turn the dial to right or left
to select an item.

Ⓑ: Joystick:
Press to confirm the item.

● Avoid pressing too much when you turn the quick search dial.



In this manual

Ⓐ: Turn [↶/↷].

Ⓑ: Press [▶/■] to confirm.

Joystick operations (see above Ⓑ for the confirming operation)

Playback (→ pages 16 and 17)

Password entry (→ pages 20 and 21)

※ You can also select items by tilting the joystick. This manual explains dial operations in most sections.



Ⓒ: Tilt the stick to left and
right.



Ⓒ: Tilt the joystick to [◀/▶].

Volume control



Ⓓ: Tilt the stick up and
down.



Ⓓ: Tilt the joystick to [△/▽].

List of menus

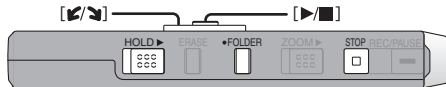

- ① Press and hold [•FOLDER/– MENU] for 1 second or longer (while stopped) to display menus.
- ② Turn [↙/↘] and press [▶/■] to confirm.

! Press [STOP] to stop an operation midway/cancel the setting.

! If an operation is not started within 60 seconds, unfinished settings are canceled.

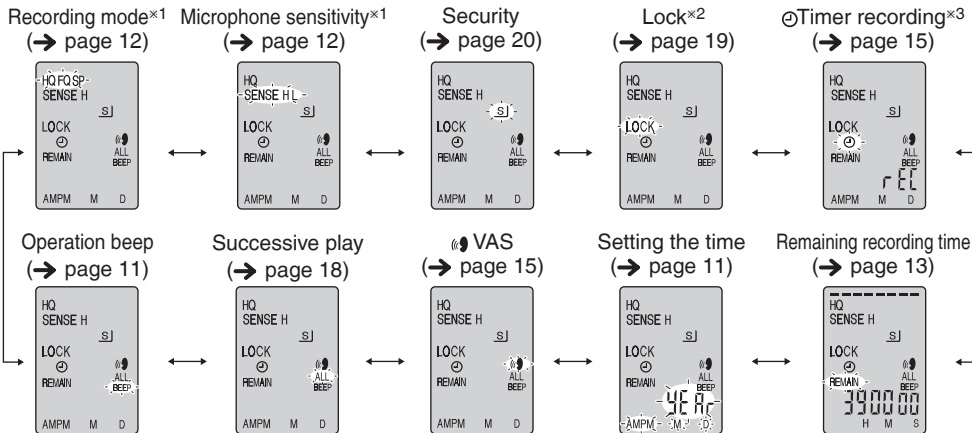

*1 Displayed only when a Meeting Recording folder (A, B, C or S) is selected.

*2 Displayed only when there is a recorded file.

*3 Displayed only when the clock is set.

Setting the time

- When the year is flashing (e.g. “2008” or “2007” on the display), begin from step 4.

1 Set Hold off (→ page 5)

2 Display the menu

While stopped, press and hold [•FOLDER/– MENU] for 1 second or longer.

3 Select “YE AR”

Turn [↖/↗] to select “YE AR” and press [▶/■] to confirm.

4 Set the time

Turn [↖/↗] and press [▶/■] to confirm. (Press [STOP] after confirming ⑤.)

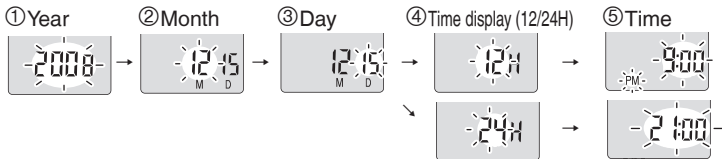

- The clock operates with the monthly error margin of +/- 60 seconds at room temperature.
- The clock returns to standby when you perform no time setting operation for 60 seconds. If this happens restart setting the time.

Canceling the operation beep

1 Display the menu

While stopped, press and hold [•FOLDER/– MENU] for 1 second or longer.

2 Select “BEEP”

Turn [↖/↗] and press [▶/■] to confirm.

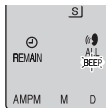

3 Select “OFF”

- ① Turn [↖/↗] and press [▶/■] to confirm.
- ② Press [STOP].



- To use the operation beep, select “ON” in step 3.

Recording

Meeting recording

Using different combinations of recording modes and microphone sensitivity levels, you can adjust audio quality according to recording situations.

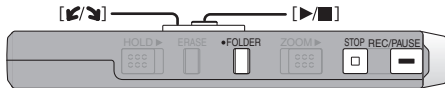

1 Select a Meeting Recording folder (A, B, C or S)

Press [•FOLDER/ - MENU].

Each time you press

A] → B] → C] → S]
└─── M] ───

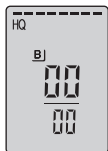

2 Display the recording mode menu

- 1 Press and hold [•FOLDER/ - MENU] for 1 second or longer.
- 2 After making sure the display at right, press [▶/■] to confirm.



3 Select the recording mode

- 1 Turn [◀/▶].
HQ ↔ FQ ↔ SP
- 2 Press [▶/■] to confirm.



HQ: High quality
FQ: Fine quality
SP: Standard play
● The factory setting is "HQ".

4 Select the microphone sensitivity level

- 1 Press [▶/■] to display microphone sensitivity.
- 2 Turn [◀/▶] and press [▶/■] to confirm.
- 3 Press [STOP].



H: Far
L: Near

5 Record

Press [REC/PAUSE].

Display during recording

Display changes depending on recording levels.

Light stays on while recording. (Flashes while paused.)

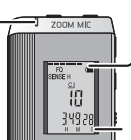

Recording elapsed time (Flashes while paused.)

Other recording methods

■ Zoom recording (recording target voice clearly)

Not on RR-US430

Zoom recording enables you to clearly record sounds coming from the direction this unit is aimed at. It is suitable for recording lectures and interviews. Select Meeting Recording folders (→ page 12).

Aim this unit to the sound you want to record and slide [ZOOM ►] toward the arrow.

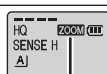

“ZOOM” is displayed when zoom recording is being used.

- ❗ Do not block the zoom microphone (→ page 8) intentionally with your fingers or other items.
- Zoom recording can be switched on and off even when Hold is on.
- The zoom function does not work when you select folder M or when you use an external microphone.

■ Recording through an external microphone

- When you attach an external microphone, the built-in microphone automatically goes off.
Plug type: $\varnothing 3.5$ mm (1/8 in.) monaural mini plug

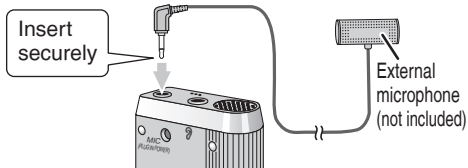

■ Listening to the recording in progress

- Connect earphones (not included).
(Sounds are monaural.)
Plug type: $\varnothing 3.5$ mm (1/8 in.) mini plug
- The volume is fixed for recording.

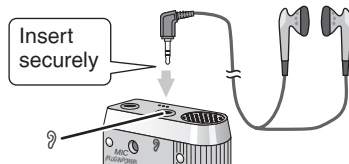

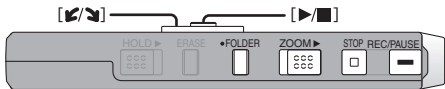

■ Preventing unnecessary recording (VAS: Voice Activated System)

Recording is automatically paused if there is no sound for more than 3 seconds.

1 Display the menu

Press and hold [FOLDER/MENU] for 1 second or longer.

2 Select “☺”

Turn [↙/↘] and press [▶/■] to confirm.



3 Select “0n”

① Turn [↙/↘] and press [▶/■] to confirm.

② Press [STOP].



4 Record

(→ page 12) “☺” flashes when the VAS function is active.

❗ Turn the function off when recording important files.

● To turn the function off, select “OFF” in step 3.

■ Timer recording

Timer recording can be set to make 1 recording at a specified time. After setting the timer, you can keep the unit on standby by setting hold on (→ page 5).

Preparation: Select the folder to be recorded to and the recording settings (→ page 12).

1 Display the menu

Press and hold [FOLDER/MENU] for 1 second or longer.

2 Select “☺”

Turn [↙/↘] and press [▶/■] to confirm.



3 Select “0n”

Turn [↙/↘] and press [▶/■] to confirm.



① Start time

Turn [↙/↘] and press [▶/■] to confirm.



② Finish time

Turn [↙/↘] and press [▶/■] to confirm.



❗ You can stop timer recording in progress, but you cannot bring it to a pause.

● To confirm the recording start and finish time, perform step 2.

● To cancel the timer, select “OFF” in step 3.

● To close the menu, press [STOP].

Playing

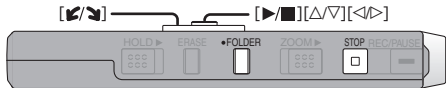

1 Select the folder

Press
[•FOLDER/– MENU].

Each time you press

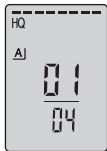
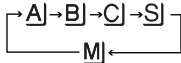

2 Select the file

Turn [↙/↘].

- After selection, information at the time of recording is displayed.

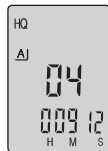

3 Play

Press [▶/■].

- When you press [▶/■] again, playback pauses. Press once more to resume playback.

■ While a file is being played

Adjusting the volume

Tilt the joystick to [△/▽]. (Volume range is 0 to 20. Factory setting is 13.)

Moving forward

Tilt the joystick to [▷].

Tilt and hold to search (→ page 17).

Moving backward

Tilt the joystick to [◁].

Tilt it twice to play the previous file. (Tilting once starts the playback of the previous file when it has been playing for less than 3 seconds.)

Tilt and hold to search (→ page 17).

Making recorded sounds easier to catch (reducing noise)

① Press [•FOLDER/– MENU] while playing.

② Turn [↙/↘] to select “EQ” (“EQ” flashes when selected) and press [▶/■] to confirm.

③ Turn [↙/↘] to select “01n” and press [▶/■] to confirm.

● To cancel, select “OFF” in step ③.



Other playing methods

■ Searching points for listening (fast forward and fast backward)

Quick search

Turn [↶/↷] while playing.

- You can search forward/backward quickly without sound (except the operation beep).
- The fast forward and fast backward speed changes according to the dial turning speed.
- To return to normal playback, stop turning.

Slow search

While playing, tilt the joystick to [◀/▶] and hold it in the position for 1 second or longer.

- You can search slowly with sound.
- To return to normal playback, release your finger.

■ Changing the playback speed

Playback is available at 5 different speeds.

Press
[•FOLDER/
-MENU]
while
playing.

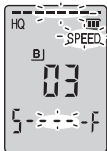

The playback speed rises as the flashing bars move right. The illustration shows the display for the normal speed playback.

Turn [↶/↷] to select “SPEED” (“SPEED” flashes when selected), press [▶/■] to confirm, and then turn [↶/↷] to select the playback speed.

The unit performs playback at the selected speed.

- The bar flashes when listening at a playback speed other than normal.



When playing back at the double speed

- To return to the normal playback speed, move the flashing bars to the center in the way instructed at left.

Other playing methods

■ Playing files successively

Files stored in the same folder are played successively.

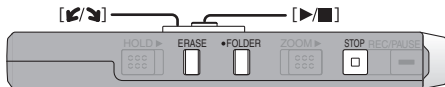

1 Display the menu

Press and hold [•FOLDER/–MENU] for 1 second or longer.

2 Select “ALL”

Turn [◀/▶] and press [▶/■] to confirm.



3 Select “0n”

- ① Turn [◀/▶] and press [▶/■] to confirm.
- ② Press [STOP].



4 Play

Press [▶/■].



- The unit plays all files in order from the selected one to the last one.
- When the last file finishes, playback stops automatically.
- Press [STOP] twice to stop successive play midway.
- To cancel, select “OFF” in step 3.

■ Listening with earphones

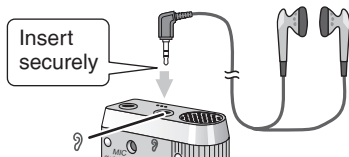

Connect earphones (not included).
(Sounds are monaural.)
Plug type: ø 3.5 mm (1/8 in.) mini plug

- The speaker is automatically turned off when earphones are used.

Organizing files

■ **Deleting** (a file/ all files in a folder/ all folders except S/ all folders)

1 Display the deleting menu
Press [ERASE].



2 Select a file or folder
Turn [←/→].



Selecting a file



All files in a folder



All folders except S



All folders

3 Delete
Press and hold [ERASE] for 1 second or longer.

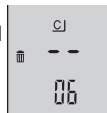

When a file is deleted.

- ! Deleted files cannot be recovered.
- Protected files cannot be deleted.

■ **Moving**

Files can be moved both ways among folders A, B and C.

Files can be moved from folder M to folders A, B, C and S, but files cannot be moved to folder M.

Preparation: Play the file to be moved (→ page 16).

1 Display the moving menu

Press and hold [•FOLDER/ - MENU] for 1 second or longer.

2 Select the destination folder
Turn [←/→].

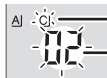

Destination folder

Number of files in the destination folder

3 Move

Press and hold [▶/■] for 1 second or longer.

Play will stop and the file is moved to the end of the selected folder.

■ **Lock (file protection)**

Preparation: Select a folder containing a file to protect.

1 Display the menu

Press and hold [•FOLDER/ - MENU] for 1 second or longer.

2 Select "LOCK"

Turn [←/→] and press [▶/■] to confirm.



3 Select the file you want to lock

- ① Turn [←/→] and press [▶/■] to confirm.
- ② Press [STOP].



- To unlock, select the file you want to unlock, then confirm.

Security functions

Security functions of this unit

This unit has 2 security functions.

- ① Password set in this unit
- ② Authentication key set with Voice Editing (See Voice Editing Ver.2.0 Operating Instructions (PDF file).)

Folder S and password

- Folder S is used to secure files. Once set, a password is necessary for playing files in this folder.
- The password is a 4-digit number. You can set the password using any combination of numbers. To play files in folder S, enter the password you set.
- You can move files in other folders to folder S, but you cannot move files in folder S to any of the other folders unless the password matches.

Setting the password

1 Display the menu

Press and hold [FOLDER/– MENU] for 1 second or longer.

2 Select “ S ”

Turn [↙/↘] and press [▶/■] to confirm.



3 Select “ 0n ”

Turn [↙/↘] and press [▶/■] to confirm.



4 Set the password

- ① Turn [↙/↘] to select a number.
- ② Press [▶/■] to move to the next digit. After entering the fourth number, press [▶/■] to confirm.
- ③ Press [STOP].



- ❗ Write down the password in the MEMO space (above) to keep it in memory.
- To initialize the password, select “ 0FF ” in step 3 and enter the password you set.
- To move among digits, tilt the joystick to [◀/▶] in step 4.

MEMO

Password (This unit)	
Authentication key (Voice Editing)	

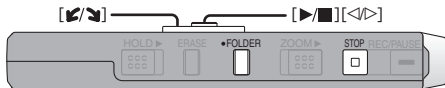

Playback using the password

1 Select folder S 2 Select a file to be played 3 Enter the password

- ① Press [•FOLDER/
-MENU].
- ② Select “”.

- ① Turn [].
- ② Press [] to confirm.

- ① Enter the 4-digit password.
- ② Press [].

- ❗ When the password matches, the security function using the password is suspended for 10 minutes.
- ❗ When the password is released and no operation is performed for 10 minutes, the password is automatically set and files in folder S become unplayable.
- ❗ When wrong passwords are entered 5 times in succession, the unit stops accepting password entry for 15 minutes.

When you forget the password

Initialize the password by taking the steps below.

- ① Release all locks set on files in folder S (→ page 19).
- ② Delete all files in folder S. (Deleted files cannot be recovered.)
- ③ Enter the security menu and set the password as “0000”.

- You can also keep the files in folder S and just delete the password. Connect this unit to a computer and use the computer to delete the password. (See Voice Editing Ver.2.0 Operating Instructions (PDF file).)

This security function is only to limit a playback function for files by password, not by encryption. We do not guarantee any kind of loss in case your password gets broken up.





When the password matches

The password is temporarily released and the selected file in folder S is played.

When the password is wrong

The unit beeps twice (→ page 11) and the password entry display reappears.

How folder S is displayed

-  Password is not set
-  Password is set
-  During password entry/ password release/playback
-  Password release to end in 10 seconds

Recording to/from a cassette tape

Read the operating instructions for the connected equipment.

■ Recording to a cassette tape recorder etc.

Select the file to copy and play  **Record**

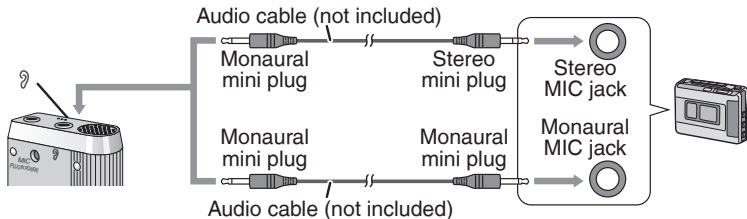

■ Recording from a cassette tape recorder etc.

Start playing  **Record**
Press [REC/PAUSE]

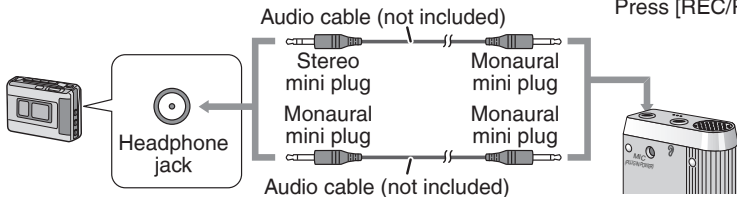

- The recorded sound may differ from the original recording.
- Adjust the recording volume on the source to the desired level.

Using the unit with a computer

- Voice Editing Ver.2.0 Premium Edition (hereinafter **Pr**) is included for RR-US490, RR-US470 and RR-US450.
- Voice Editing Ver.2.0 Standard Edition (hereinafter **S**) is included for RR-US430.

RR-US490

- There are 2 CD-ROMs for **Pr**.

RR-US470

RR-US450

RR-US430

- There are 2 CD-ROMs for **Pr** for Canada. **Pr** for the U.S.A. and **S** for both countries occupy 1 CD-ROM only.

1 Installing Voice Editing

① Start Windows.

② Insert the included CD-ROM (or CD-ROM #1) into your computer's CD-ROM drive.

The program installer starts automatically.

- When the installer does not automatically start

(1) From the "Start" menu click "Run".

(2) Type "※:\Launcher\VEdV1Launcher.exe" and click "OK". ※ is the CD-ROM drive ID.

③ Click "Voice Editing Ver.2.0".

Installation starts. Follow on-screen instructions for any subsequent operations.

Pr **For the U.S.A.** **For Canada**

- The voice recognition engine and text to speech/translation engine should start installing while Voice Editing is being installed. (Alternatively, you can install them afterwards.)

Pr **RR-US490** **RR-US470/RR-US450 for Canada**

- Change the CD-ROM #1 for #2 according to the message that will appear in the middle of installation. Installation continues automatically.
- Change the CD-ROM #2 for #1 according to the message that will appear when the installation of #2 is complete.

④ Click "Finish" from the InstallShield Wizard Complete screen.

Selecting "Yes, I want to restart my computer now" automatically re-starts the computer and completes installation.

Using the unit with a computer

2 Connecting this unit to a computer with the USB cable

You cannot operate the unit while it is connected to a computer.

- Do not use any other USB connection cables except the supplied one.

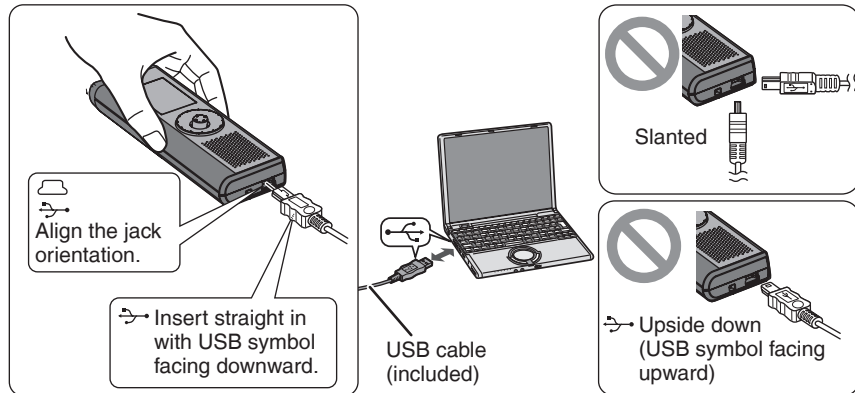

! Connect one IC Recorder only. This software does not support simultaneous use of multiple IC recorders.

Caution: Use only the included USB cable with a ferrite core when connecting to computer.

- When connected to a computer, "PL" appears. When transferring data, "PL" flashes.

! Do not disconnect the USB cable while this is flashing.



3 Starting Voice Editing

① Double-click the “Voice Editing” icon on the desktop.



After double clicking, a dialog box for entering the authentication key appears.

② Enter the “authentication key”.

- Enter an “authentication key” that has 1 to 128 characters.
- We recommend that you use a phrase that is easy to remember for the “authentication key”.
Example: *Good morning, this is Panasonic Corporation. How can I help you?*
- Write down the authentication key in the MEMO space (→ page 20) to keep it in memory.

③ Click “Settings” in the “IC Recorder Authentication Key Settings” dialog box.

④ Click “Yes” in the confirmation dialog box.

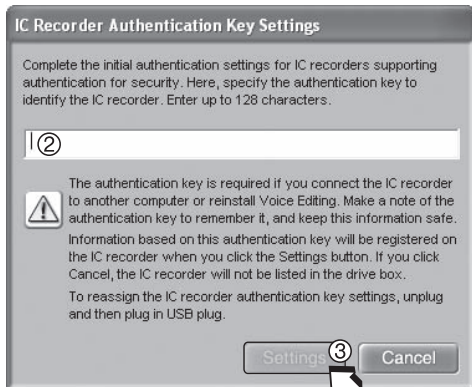

See Voice Editing Ver. 2.0 Operating Instructions (PDF file) for how to use Voice Editing and other information not provided in this manual.

■ Using the Operating Instructions (PDF file)

In the Windows “Start” menu, click “All Programs” → “Panasonic” → “Voice Editing” → “Voice Editing Operating Instructions” or in the “Help (H)” menu in the Voice Editing main screen, click “Operating Instructions (H)”.

Using the unit with a computer

■ System requirements (through page 29)

You will need an IBM PC/AT computer with the following attributes or equivalent, and the following software and hardware in order to use this application.

OS: Microsoft® Windows® 98 Second Edition
Microsoft® Windows® Millennium Edition
Microsoft® Windows® 2000 Professional *
Microsoft® Windows® XP Home Edition/Professional *

*Only available when the user is logged in as the system administrator. Cannot be used by multiple users.
(Windows® 2000 / Windows® XP only)

- Not compatible with Microsoft Windows® 3.1, Windows® 95, Windows® 98 (except for Windows® 98 SE) and Windows NT®.
- Operation is not guaranteed on an upgraded OS.
- Not compatible with Mac OS.

Hardware:

CPU: Windows® 98 SE / Windows® Me: Intel® Pentium® II 333 MHz or higher
Windows® 2000 / Windows® XP: Intel® Pentium® III 500 MHz or higher

RAM: Windows® 98 SE / Windows® Me: 128 MB or more
Windows® 2000 / Windows® XP: 256 MB or more

Free hard disk space:

Pr 70 MB or more (**For the U.S.A.**) or 150 MB or more (**RR-US490** **RR-US470/RR-US450 for Canada**)

- Additional free hard disk space may be necessary depending on the Windows® version and voice file being used.
- Additional free space is required to install Acrobat® Reader®, DirectX® 9.0c, and voice recognition/text-to-speech/translation engines (all included), as well as “Voice Editing Launcher”(Office Add-In and Internet Explorer Contextual Menu Add-In).
- Additional free space is temporarily required for sound waveform display, voice recognition, text-to-speech conversion, translation, sound recording, CD-R recording (Windows® XP only), and “Voice Editing Launcher”.
- Installing all Voice Editing functions and engines for all languages requires approximately 650 MB (**For the U.S.A.**) or 1.5 GB (**RR-US490** **RR-US470/RR-US450 for Canada**) of free space.

- S** 60MB or more (**For the U.S.A.**) or 120MB or more (**RR-US490** **RR-US470/RR-US450 for Canada**)
- Additional free hard disk space may be necessary depending on the Windows® version and voice file being used.
 - Approximately 25MB of additional free hard disk space when installing Acrobat® Reader® (included).
 - Approximately 50MB of additional free hard disk space when installing DirectX® 9.0c (included).

Drive: CD-ROM drive (for installation)

CD-R/RW drive (required to use the CD-R writing function in Windows® XP)

Sound: Windows compatible sound device

Display: High Color (16 bit) or more. Desktop resolution of 800 × 600 pixels or more.
(1024 × 768 pixels or more recommended)

Interface: USB port (Operation cannot be guaranteed if you use a USB hub or extension cable.)

Other requirements:

Mouse or equivalent pointing device

Note

The following hardware limitations should be noted.

- Not compatible with multiprocessor computers or multiboot environments.
- Operation not guaranteed on user-built computers.
- Operation not guaranteed on 64-bit computers.
- Even if the system requirements mentioned in these operating instructions are fulfilled, some personal computers cannot be used.

The following limitations should be noted.

- Voice recognition, text-to-speech, and translation engines are installed on the same drive as the operating system (usually the C drive).

Using the unit with a computer

- The operating system must support the languages of the voice recognition, text-to-speech, and translation engines.
- Before voice recognition, the speaker's voice must be registered in a training process. Sound files of speakers whose voices have not been registered in training cannot be converted to text correctly.

About Windows Vista

- Visit the following website for information about Voice Editing and using it on Windows Vista.
<http://panasonic.net/support/>

Necessary software:

DirectX® 8.1 or later / Internet Explorer 6.0

Microsoft Office 2000/XP/2003 (support for Word, Excel, and PowerPoint is required when using the Office Add-in) These features are not available in .

- Microsoft and its logo as well as Windows, Windows Vista, Windows NT and DirectX are either registered trademarks or trademarks of Microsoft Corporation in the United States and/or other countries.
- IBM and PC/AT are registered trademarks of International Business Machines Corporation of the U.S.
- Intel, Pentium and Celeron are registered trademarks or trademarks of Intel Corporation in the United States and other countries.
- Nuance, the Nuance logo, the Dragon logo, Dragon, NaturallySpeaking, and RealSpeak are trademarks and/or registered trademarks of Nuance Communications Inc., or its affiliates in the United States and/or other countries.
- Noise cancellation features of this software incorporate technology of ANIMO LIMITED.
- Adobe and its logo, Acrobat, and Acrobat Reader are trademarks of Adobe Systems Incorporated.
- FineSpeech(TM).
- Other system names and product names appearing in this document are in general the registered trademarks or trademarks of the respective developer companies.
Note that the "TM" mark and "®" mark do not appear in this document.

Pr Install and use Voice Editing Ver.2.0 Premium Edition with RR-US490, RR-US470 and RR-US450. Uninstall the following before installing this software.

You cannot install two versions of Sound File Management Software on the same computer.

- Voice Editing Ver.1.0 Premium Edition
- Voice Editing Ver.1.0 Light Edition for D-snap Audio
- Voice Editing Ver.1.0 Professional Edition
- Voice Editor 3
- Voice Editing Ver.1.0 Standard Edition
- Voice Editor 2
- Previous versions of Voice Editing software (for Panasonic IC Recorder RR-US360/RR-US361)
- SD Voice Editor Ver. 1. x

S Install Voice Editing Ver.2.0 Standard Edition when you use RR-US430. Previous versions do not work with RR-US430. Standard Edition can be installed on the same computer on which a previous version is already installed.

If you install it on the same computer, note that the new desktop icon is as shown at right.

To use only one edition, uninstall both editions and then reinstall the desired edition.



Voice Editing
Standard

- Translation (and interpretation) results are merely one example, and accuracy cannot be guaranteed. We cannot be liable for the translation results in any way. Additionally, please refrain from publishing, selling, or distributing unedited translation results, which may violate copyright law.
- Noise cancellation may not be effective in some cases, depending on the recording environment. Choosing stronger noise cancellation in the available range (1–5) may lower the volume of the recorded voice and may change its sound characteristics.
- Recording and operating problems may occur on some computer systems. Please note that Panasonic and Panasonic dealers cannot be held liable for any lost audio data or other direct or indirect damage except in cases of intentional or gross negligence.

Includes features for use in conjunction with Dragon, NaturallySpeaking dictation software (sold separately, from Nuance Communications, Inc.). For details on Dragon, NaturallySpeaking, visit the Nuance Communications website:

<http://www.nuance.com/dragon/>

Troubleshooting guide

Before requesting service, make the following checks. If you are in doubt about some of the check points, or if the remedies indicated in the chart do not solve the problem, refer to “Customer Services Directory” (→ page 41) if you reside in the U.S.A., or refer to “Product information” (→ page 38) if you reside in Canada.

Symptom	Checkpoints
“U01” appears on the display.	<ul style="list-style-type: none">• The battery has run down.
No operation.	<ul style="list-style-type: none">• Make sure the batteries are correctly inserted.• You cannot operate when the unit is connected to a computer (→ page 23).
Operation is not possible when “hold” appears on the display.	<ul style="list-style-type: none">• The Hold function is on (→ page 5).
“2008” or “2007”, “12:00” flashes.	<ul style="list-style-type: none">• Set the time (→ page 11).
“EE:EE” is displayed.	<ul style="list-style-type: none">• This can occur after repeatedly recording and deleting files.<ul style="list-style-type: none">-Unlock all your files, then delete all folders to remedy this (→ page19).
Available recording time does not increase correspondingly after deleting files.	
There is no sound from the earphone or it is difficult to hear or noisy.	<ul style="list-style-type: none">• Ensure the plug is inserted firmly.• Wipe the plug clean.
Recording stops.	<ul style="list-style-type: none">• VAS may be functioning (→ page 15).
“-- --” appears instead of the recording date.	<ul style="list-style-type: none">• Set the time (→page 11).
Playback speed is too fast or slow.	<ul style="list-style-type: none">• Set the play speed to normal (→ page 17).
“FULL” appears.	<ul style="list-style-type: none">• There are 99 files in the folder.• There is no remaining recording time.<ul style="list-style-type: none">-Delete unneeded files (→ page 19).

Symptom	Checkpoints
No sound from the speaker	<ul style="list-style-type: none"> • There is no sound when you have connected earphones.
Cannot delete a file or folder.	<ul style="list-style-type: none"> • The file is protected (→ page 19). • The folder is already empty.
Cannot move a file.	<ul style="list-style-type: none"> • You cannot move files to folders that already contain 99 files. • You cannot move files from folder A, B, C or S to the dictation folder. • You cannot move files from folder S unless the password matches.
Cannot play	<ul style="list-style-type: none"> • You tried to play secured files in folder S. You must enter a password set on this unit to play files in folder S (→ pages 20 and 21).
A recording disappeared.	<ul style="list-style-type: none"> • Recordings can disappear if the unit receives a shock (e.g. it is dropped), or the batteries go out during recording.
Cannot set timer recording.	<ul style="list-style-type: none"> • The timer covers 24 hours from the present time only. • You cannot set a recording period longer than 24 hours using the timer. • Set the time (→ page 11). • You cannot set the timer if there is less than 1 minute of available recording time.
Timer recording does not work.	<ul style="list-style-type: none"> • The settings are canceled if the batteries are removed and the clock settings are cleared. • Timer recording does not work if the unit is used for playback or another operation at a set time. • Timer recording setting is canceled once timer recording is performed. Set the timer again when necessary (→ page 15).
Files created through timer recording are shorter than periods set with the timer.	<ul style="list-style-type: none"> • VAS may be “On” (→ page 15).
Cannot use a battery that can be used on other equipment.	<ul style="list-style-type: none"> • This unit considers the battery as empty even if there is actually power left in it. This is to preserve the clock and other memory items.
Recorded sounds contain noise that makes them difficult to catch.	<ul style="list-style-type: none"> • Reduce noise (→ page 16). Noise is reduced and listening becomes easier. Recording in the HQ mode is recommended. (This unit is designed for extended recording of human voice. It is not suited for recording music.)

Troubleshooting guide

Symptom	Checkpoints
Sound is distorted.	<ul style="list-style-type: none">• Non-voice recordings such as music on CDs may become distorted in playback.
Sound is distorted when listening to the recording in progress with earphones.	<ul style="list-style-type: none">• Keep earphones and the microphone you are using separate.
Message appears when connecting to a computer.	<ul style="list-style-type: none">• A message appears when you connect this unit to a computer for the first time. It asks you to enter an authentication key. The key is used for authenticating the unit and the computer.
I hear noises.	<ul style="list-style-type: none">• Move the mobile telephone away from this unit when you use the two in the same area.
Voice Editing does not start or does not work correctly.	<ul style="list-style-type: none">• Make sure that “PC” is on this unit’s display, and that this unit is recognized as a drive in Voice Editing. Set the USB cable in and out of IC Recorder’s USB jack several times when the unit is not recognized as a drive.• The connection may not work if you connect via a USB hub or a USB extension cable.
I used the “Dictation cord” supplied with the unit, but microphone sensitivity did not improve. Computer voice recognition level is still low.	<ul style="list-style-type: none">• Depending on your computer, you may also be able to improve the sensitivity by reversing the “Straight mini plug” and the “L-shaped mini plug” connections.
Cannot successfully convert audio to text with Voice Editing.	<ul style="list-style-type: none">• You should use IC Recorder in the dictation recording mode. You can make better recordings for voice recognition in this recording mode (→ page 7). (Refer to the Voice Editing Operating Instructions (PDF file).)

Specifications

Power requirement:	DC 3.0 V (2 AAA size/LR03 batteries)
Power output:	300 mW (max.)
Frequency response:	300 Hz to 5,000 Hz (HQ mode), 300 Hz to 3,400 Hz (FQ/SP mode)
S/N:	37 dB (HQ mode)
Output jack:	Earphone, \varnothing 3.5 mm ($1/8$ in.); 0.5 mW 16 Ω
Input jack:	Mic, \varnothing 3.5 mm ($1/8$ in.); 0.56 mV plug in power
Speaker:	20 mm ($25/32$ in.) 8 Ω
Dimensions (W x H x D):	
Max dimensions;	39.3 mm x 105.5 mm x 17.2 mm (1 $9/16$ in. x 4 $5/32$ in. x $11/16$ in.)
Cabinet dimensions;	38.8 mm x 105 mm x 14 mm (1 $17/32$ in. x 4 $1/8$ in. x $9/16$ in.)
Mass (Weight):	
With dry cell batteries;	
Approx. 62 g or 2.17 oz. (RR-US490/RR-US470)/61 g or 2.13 oz. (RR-US450)/60 g or 2.11 oz. (RR-US430)	
Without batteries;	
Approx. 39 g or 1.37 oz. (RR-US490/RR-US470)/38 g or 1.33 oz. (RR-US450)/37 g or 1.31 oz. (RR-US430)	
Operational temperature range:	0 °C to 40 °C (32 °F to 104 °F)
Memory capacity (MB means one million bytes. Usable capacity will be less.):	
512 MB (RR-US490)/256 MB (RR-US470)/128 MB (RR-US450)/64 MB (RR-US430)	
Operating Humidity:	20 % to 80 % (non-condensing)
Battery life:	[When used at 25 °C (77 °F) on a flat, stable surface]

The battery life may be less depending on the operating conditions.

Batteries	Recording mode	Playback	Recording	
Panasonic alkaline batteries	Monaural	HQ	12 hours	21 hours (When not zoom recording)
		FQ/SP	15 hours	30 hours (When not zoom recording)

- Specifications are subject to change without notice.

Product Identification Marking is located on the bottom of unit.

Maintenance

Do not use such solvents as benzene, paint thinner and alcohol for cleaning.

- Solvents may cause casing to deform and coating to go off.
- Wipe dust and fingerprints off using a soft, dry cloth. Soak the cloth in water, wring it thoroughly and use it for cleaning when the unit is very dirty. Wipe moisture off with a dry cloth after removing tough dirt.
- Do not use kitchen detergents or chemically-enhanced cleaning cloths.

-If you see this symbol-

Information on Disposal in other Countries outside the European Union



This symbol is only valid in the European Union.
If you wish to discard this product, please contact your local authorities or dealer and ask for the correct method of disposal.

CAUTION

Danger of explosion if battery is incorrectly replaced. Replace only with the same or equivalent type recommended by the manufacturer.

Dispose of used batteries according to the manufacturer's instructions.

FC **Panasonic**
RR-US490

FC **Panasonic**
RR-US450

FC **Panasonic**
RR-US470

FC **Panasonic**
RR-US430

Care and use

To reduce risk of radio interference caused by headphone-, earphone- or microphone cables, only use adequate accessories with the cable length less than 3 m (9.8 ft.).

■ Unit

- Avoid using or placing this unit near sources of heat.
- To avoid product damage, do not expose this product to rain, water or other liquids.
- The unit's speaker does not have magnetic shielding. Do not place the unit near televisions, personal computers, magnetized cards (bank cards, commuter passes) or other devices easily influenced by a magnet.

■ Batteries

- Do not peel off the covering on batteries and do not use the batteries if the covering has been peeled off.
- Align the poles ⊕ and ⊖ correctly when inserting the batteries.
- Do not mix different types of batteries or old and new batteries.
- Remove the batteries if you do not intend to use the unit for a long time.
- Do not heat or expose to flame.
- Do not leave the batteries in an automobile exposed to direct sunlight for a long period of time with doors and windows closed.
- Do not attempt to recharge dry cell batteries.
- Battery mishandling can cause electrolyte leakage which can damage items the fluid contacts and may cause a fire. If electrolyte leaks from the batteries, consult your dealer. Wash thoroughly with water if electrolyte comes in contact with any part of your body.
- Keep batteries out of reach of children to prevent swallowing.
- When carrying batteries in a pocket or bag, ensure no metal objects such as necklaces are placed together with them. Contact with metal may cause short-circuiting which can cause a fire. For safety, carry the rechargeable batteries in the battery carrying case.

Care and use

■ Allergies

Discontinue use if you experience discomfort with the earphones or any other parts that directly contact your skin.

Continued use may cause rashes or other allergic reactions.

■ Listening caution



Do not play your headphones or earphones at a high volume. Hearing experts advise against continuous extended play.

If you experience a ringing in your ears, reduce volume or discontinue use.

Do not use while operating a motorized vehicle. It may create a traffic hazard and is illegal in many areas.

You should use extreme caution or temporarily discontinue use in potentially hazardous situations.

Even if your headphones or earphones are the open-air type designed to let you hear outside sounds, don't turn up the volume so high that you can't hear what's around you.

Sound can be deceiving. Over time your hearing “comfort level” adapts to higher volumes of sound. So what sounds “normal” can actually be loud and harmful to your hearing.

Guard against this by setting your equipment at a safe level BEFORE your hearing adapts.

To establish a safe level:

- Start your volume control at a low setting.
- Slowly increase the sound until you can hear it comfortably and clearly, and without distortion.

Once you have established a comfortable sound level:

- Leave it there.

This product may receive radio interference caused by mobile telephones or other products during operation. If such interference is apparent, please increase separation between the product and the mobile telephone or other product.

Product service

- 1. Damage requiring service** – The unit should be serviced by qualified service personnel if:
 - (a) Objects or liquids have gotten into the unit; or
 - (b) The unit has been exposed to rain; or
 - (c) The unit does not operate normally or exhibits a marked change in performance; or
 - (d) The unit has been dropped or the cabinet damaged.
- 2. Servicing** – Do not attempt to service the unit beyond that described in these operating instructions. Refer all other servicing to authorized servicing personnel.
- 3. Replacement parts** – When parts need replacing ensure the servicer uses parts specified by the manufacturer or parts that have the same characteristics as the original parts. Unauthorized substitutes may result in fire, electric shock, or other hazards.
- 4. Safety check** – After repairs or service, ask the servicer to perform safety checks to confirm that the unit is in proper working condition.

Product information

For product information or assistance with product operation:

In the U.S.A., refer to “Customer Services Directory” (→ page 41).

For assistance in the continental U.S.A. in obtaining repairs please ship the product to:

Panasonic Service and Technology Company- Customer Servicenter
Suite B 4900 George McVay Drive
McAllen, TX 78503

In Puerto Rico contact the Panasonic Puerto Rico, Inc.

Tel. (787) 750-4300

Fax. (787) 768-2910

When shipping the unit carefully pack and send it prepaid, adequately insured and preferably in the original carton. Include a letter detailing the complaint and provide a day time phone number where you can be reached.

IF REPAIR IS NEEDED DURING THE WARRANTY PERIOD THE PURCHASER WILL BE REQUIRED TO FURNISH A SALES RECEIPT/PROOF OF PURCHASE INDICATING DATE OF PURCHASE, AMOUNT PAID AND PLACE OF PURCHASE, CUSTOMER WILL BE CHARGED FOR THE REPAIR OF ANY UNIT RECEIVED WITHOUT SUCH PROOF OF PURCHASE.

Also, the purchaser will be responsible for shipping the unit to the address on page 38. In Canada, contact the Panasonic Canada Inc. Customer Care Centre at 1-800-561-5505, or visit the website (www.panasonic.ca), or an authorized Servicentre closest to you.

The model number and serial number of this product can be found on either the back or the bottom of the unit.

Please note them in the space provided below and keep for future reference.

MODEL NUMBER _____

SERIAL NUMBER _____

User memo:

DATE OF PURCHASE _____

DEALER NAME _____

DEALER ADDRESS _____

TELEPHONE NUMBER _____

Limited Warranty (ONLY FOR U.S.A.)

Panasonic Consumer Electronics Company,
Division of Panasonic Corporation of North America
One Panasonic Way Secaucus, New Jersey 07094

Panasonic Puerto Rico, Inc.
Ave. 65 de Infantería, Km. 9.5
San Gabriel Industrial Park, Carolina, Puerto Rico 00985

Panasonic Portable Audio Products Limited Warranty

Limited Warranty Coverage

If your product does not work properly because of a defect in materials or workmanship, Panasonic Consumer Electronics Company or Panasonic Puerto Rico, Inc. (collectively referred to as "the warrantor") will, for the length of the period indicated on the chart below, which starts with the date of original purchase ("warranty period"), at its option either (a) repair your product with new or refurbished parts, or (b) replace it with a new or a refurbished product. The decision to repair or replace will be made by the warrantor.

Product or Part Name	Parts	Labor
All Portable Audio Products except item listed below	One (1) Year	One (1) Year
Rechargeable batteries (in exchange for defective item)	Ten (10) Days	Not applicable

During the "Labor" warranty period there will be no charge for labor. During the "Parts" warranty period, there will be no charge for parts. You must mail-in your product during the warranty period. This Limited Warranty excludes both parts and labor for batteries, antennas, and cosmetic parts (cabinet). This warranty only applies to products purchased and serviced in the United States or Puerto Rico. This warranty is extended only to the original purchaser of a new product which was not sold "as is".

Mail-In Service

For assistance in the continental U.S.A. in obtaining repairs please ship the product to:

**Panasonic Service and Technology Company
Customer Servicenter
Suite B
4900 George McVay Drive
McAllen, TX 78503**

For assistance in Puerto Rico call Panasonic Puerto Rico, Inc. (787)-750-4300 or fax (787)-768-2910.

When shipping the unit carefully pack and send it prepaid, adequately insured and preferably in the original carton. Include a letter detailing the complaint and provide a day time phone number where you can be reached.

IF REPAIR IS NEEDED DURING THE WARRANTY PERIOD THE PURCHASER WILL BE REQUIRED TO FURNISH A SALES RECEIPT/PROOF OF PURCHASE INDICATING DATE OF PURCHASE. AMOUNT PAID AND PLACE OF PURCHASE. CUSTOMER WILL BE CHARGED FOR THE REPAIR OF ANY UNIT RECEIVED WITHOUT SUCH PROOF OF PURCHASE.

Limited Warranty Limits And Exclusions

This warranty ONLY COVERS failures due to defects in materials or workmanship, and DOES NOT COVER normal wear and tear or cosmetic damage. The warranty ALSO DOES NOT COVER damages which occurred in shipment, or failures which are caused by products not supplied by the warrantor, or failures which result from accidents, misuse, abuse, neglect, mishandling, misapplication, alteration, faulty installation, set-up adjustments, misadjustment of consumer controls, improper maintenance, power line surge, lightning damage, modification, introduction of sand, humidity or liquids, commercial use such as hotel, office, restaurant, or other business or rental use of the product, or service by anyone other than a Factory Servicenter or other Authorized Servicer, or damage that is attributable to acts of God.

THERE ARE NO EXPRESS WARRANTIES EXCEPT AS LISTED UNDER "LIMITED WARRANTY COVERAGE".

THE WARRANTOR IS NOT LIABLE FOR INCIDENTAL OR CONSEQUENTIAL DAMAGES RESULTING FROM THE USE OF THIS PRODUCT, OR ARISING OUT OF ANY BREACH OF THIS WARRANTY. (As examples, this excludes damages for lost time, travel to and from the servicer, loss of or damage to media or images, data or other memory or recorded content. The items listed are not exclusive, but are for illustration only.)

ALL EXPRESS AND IMPLIED WARRANTIES, INCLUDING THE WARRANTY OF MERCHANTABILITY, ARE LIMITED TO THE PERIOD OF THE LIMITED WARRANTY.

Some states do not allow the exclusion or limitation of incidental or consequential damages, or limitations on how long an implied warranty lasts, so the exclusions may not apply to you.

Service in Puerto Rico

*Panasonic Puerto Rico, Inc.
Ave. 65 de Infantería, Km. 9.5, San Gabriel Industrial
Park, Carolina, Puerto Rico 00985
Phone (787)750-4300, Fax (787)768-2910*

This warranty gives you specific legal rights and you may also have other rights which vary from state to state. If a problem with this product develops during or after the warranty period, you may contact your dealer or Servicenter. If the problem is not handled to your satisfaction, then write to the warrantor's Consumer Affairs Department at the addresses listed for the warrantor.

PARTS AND SERVICE, WHICH ARE NOT COVERED BY THIS LIMITED WARRANTY, ARE YOUR RESPONSIBILITY.

Customer Services Directory

Obtain Product Information and Operating Assistance; locate your nearest Dealer or Servicenter; purchase Parts and Accessories; or make Customer Service and Literature requests by visiting our Web Site at:

<http://www.panasonic.com/consumersupport>

or, contact us via the web at:

<http://www.panasonic.com/contactinfo>

You may also contact us directly at:

1-800-211-PANA (7262),

Monday-Friday 9 am-9 pm; Saturday-Sunday 10 am-7 pm, EST.

For hearing or speech impaired TTY users, TTY: 1-877-833-8855

Accessory Purchases

Purchase Parts, Accessories and Instruction Books online for all Panasonic Products by visiting our Web Site at:

<http://www.pstc.panasonic.com>

or, send your request by E-mail to: npcparts@us.panasonic.com

You may also contact us directly at:

1-800-332-5368 (Phone) 1-800-237-9080 (Fax Only)

(Monday - Friday 9 am to 9 pm, EST.)

Panasonic Service and Technology Company

20421 84th Avenue South, Kent, WA 98032

(We Accept Visa, MasterCard, Discover Card, American Express, and Personal Checks)

For hearing or speech impaired TTY users, TTY: 1-866-605-1277

Limited Warranty (ONLY FOR CANADA)

Panasonic Canada Inc.

PANASONIC PRODUCT – LIMITED WARRANTY

Panasonic Canada Inc. warrants this product to be free from defects in material and workmanship and agrees to remedy any such defect for a period as stated below from the date of original purchase.

Technics Audio Product

Panasonic Portable / Clock Radio (without Tape, CD, MD)

Panasonic Audio / SD Audio Product

Panasonic DVD Product

Panasonic Combination DVD Player / VCR

Panasonic Combination DVD Recorder / VCR

Accessories including rechargeable batteries

One (1) year, parts and labour

One (1) year, parts and labour

One (1) year, parts and labour

One (1) year, parts and labour

One (1) year, parts and labour

One (1) year, parts and labour

Ninety (90) days

LIMITATIONS AND EXCLUSIONS

This warranty does not apply to products purchased outside Canada or to any product which has been improperly installed, subjected to usage for which the product was not designed, misused or abused, damaged during shipping, or which has been altered or repaired in any way that affects the reliability or detracts from the performance, nor does it cover any product which is used commercially. Dry cell batteries are also excluded from coverage under this warranty.

This warranty is extended to the original end user purchaser only. A purchase receipt or other proof of date of original purchase is required before warranty service is performed.

THIS EXPRESS, LIMITED WARRANTY IS IN LIEU OF ALL OTHER WARRANTIES, EXPRESS OR IMPLIED, INCLUDING ANY IMPLIED WARRANTIES OF MERCHANTABILITY AND FITNESS FOR A PARTICULAR PURPOSE. IN NO EVENT WILL PANASONIC CANADA INC. BE LIABLE FOR ANY SPECIAL, INDIRECT OR CONSEQUENTIAL DAMAGES.

In certain instances, some jurisdictions do not allow the exclusion or limitation of incidental or consequential damages, or the exclusion of implied warranties, so the above limitations and exclusions may not be applicable.

WARRANTY SERVICE

FOR PRODUCT OPERATION ASSISTANCE, please contact:

Our Customer Care Centre:	Telephone #:	(905) 624-5505
	1-800 #:	1-800-561-5505
	Fax #:	(905) 238-2360
	Email link:	"Customer support" on www.panasonic.ca

FOR PRODUCT REPAIRS, please locate your nearest Authorized Servicentre at www.panasonic.ca :

Link : "Servicentres™ locator" under "Customer support"

IF YOU SHIP THE PRODUCT TO A SERVICENTRE

Carefully pack and send prepaid, adequately insured and preferably in the original carton.
Include details of the defect claimed, and proof of date of original purchase.

THE FOLLOWING APPLIES ONLY IN THE U.S.A.

FCC Note:

This equipment has been tested and found to comply with the limits for a Class B digital device, pursuant to Part 15 of the FCC Rules. These limits are designed to provide reasonable protection against harmful interference in a residential installation. This equipment generates, uses, and can radiate radio frequency energy and, if not installed and used in accordance with the instructions, may cause harmful interference to radio communications. However, there is no guarantee that interference will not occur in a particular installation. If this equipment does cause harmful interference to radio or television reception, which can be determined by turning the equipment off and on, the user is encouraged to try to correct the interference by one or more of the following measures:

- Reorient or relocate the receiving antenna.
- Increase the separation between the equipment and receiver.
- Connect the equipment into an outlet on a circuit different from that to which the receiver is connected.
- Consult the dealer or an experienced radio/TV technician for help.

FCC Caution: To assure continued compliance, follow the attached installation instructions and use only shielded interface cables with ferrite core when connecting to computer or peripheral devices.

Any changes or modifications not expressly approved by the party responsible for compliance could void the user's authority to operate this equipment.

Declaration of Conformity

Trade Name: Panasonic

Model No.: RR-US490/RR-US470/RR-US450/RR-US430

Responsible party: Panasonic Corporation of North America One Panasonic Way, Secaucus, NJ 07094

Support Contact: Panasonic Consumer Electronics Company 1-800-211-PANA (7262)

This device complies with Part 15 of the FCC Rules. Operation is subject to the following two conditions: (1) This device may not cause harmful interference, and (2) this device must accept any interference received, including interference that may cause undesired operation.

THE FOLLOWING APPLIES ONLY IN CANADA.

This Class B digital apparatus complies with Canadian ICES-003.

Panasonic Consumer Electronics Company,
Division of Panasonic Corporation of North America
One Panasonic Way Secaucus, New Jersey 07094
<http://www.panasonic.com>

Panasonic Puerto Rico, Inc.
Ave. 65 de Infantería, Km. 9.5 San Gabriel Industrial Park,
Carolina, Puerto Rico 00985

Panasonic Canada Inc.
5770 Ambler Drive, Mississauga, Ontario L4W 2T3
www.panasonic.ca
© Panasonic Corporation 2008
Printed in Malaysia



RQT8824-MP
H1206WW2088