

Contents

Exploded view	1
Wiring connection	1
Parts list	2
Wiring diagram	
(LCD) Pattern side view	2
Parts side view	3
(MAIN) Pattern side view	3
Parts side view	3
Schematic diagram	4

PRODUCT CODE No.
164 125 03

EXPLODED VIEW

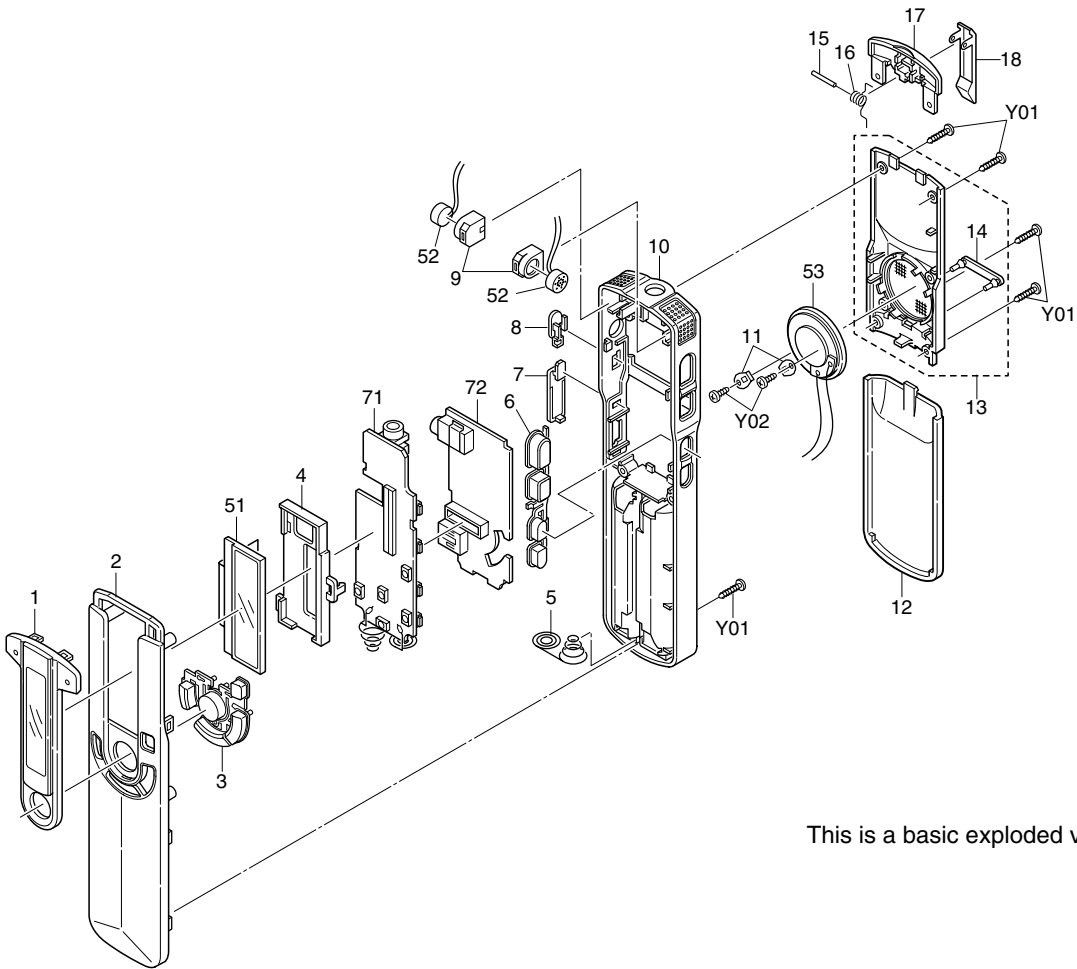

This is a basic exploded view.

WIRING CONNECTION

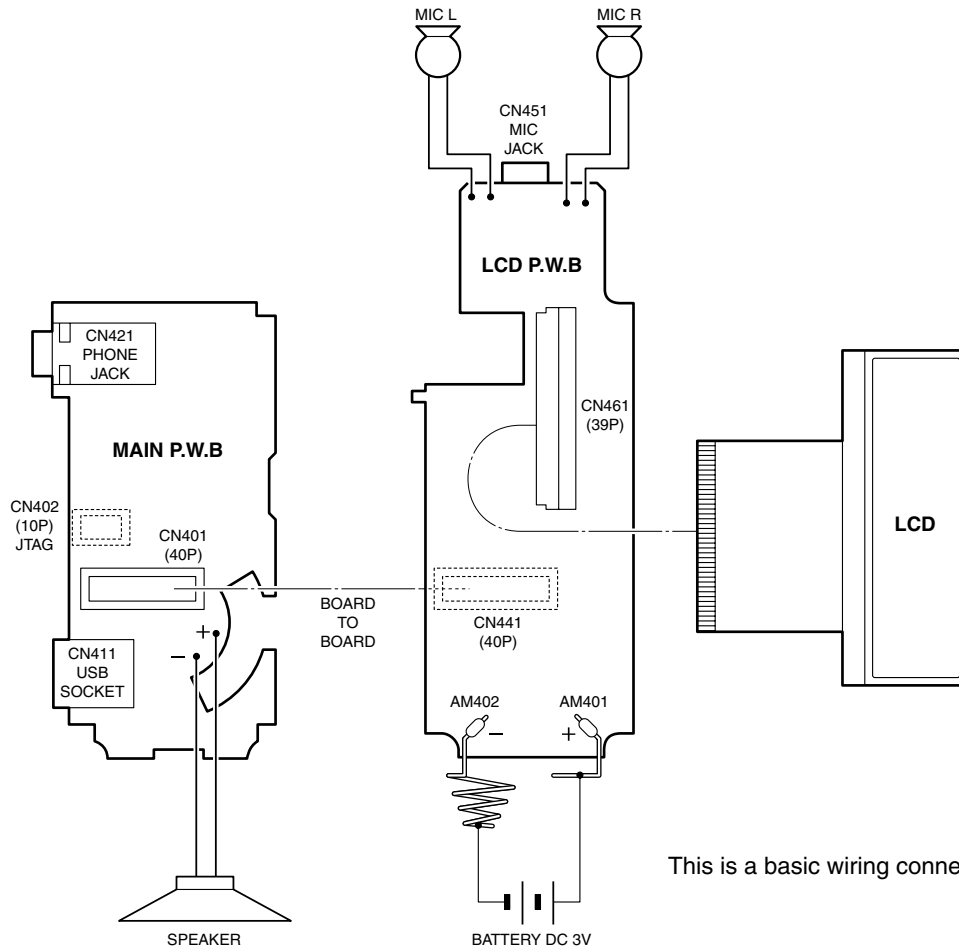

This is a basic wiring connection.

PARTS LIST

PRODUCT SAFETY NOTICE

EACH PRECAUTION IN THIS MANUAL SHOULD BE FOLLOWED DURING SERVICING. COMPONENTS IDENTIFIED WITH THE IEC SYMBOL Δ IN THE PARTS LIST AND THE SCHEMATIC DIAGRAM DESIGNATED COMPONENTS IN WHICH SAFETY AND PERFORMANCE CAN BE OF SPECIAL SIGNIFICANCE. WHEN REPLACING A COMPONENT IDENTIFIED BY Δ, USE ONLY THE REPLACEMENT PARTS DESIGNATED, OR PARTS WITH THE SAME RATINGS OF RESISTANCE, WATTAGE OR VOLTAGE THAT ARE DESIGNATED IN THE PARTS LIST IN THIS MANUAL. LEAKAGE-CURRENT OR RESISTANCE MEASUREMENTS MUST BE MADE TO DETERMINE THAT EXPOSED PARTS ARE ACCEPTABLY INSULATED FROM THE SUPPLY CIRCUIT BEFORE RETURNING THE PRODUCT TO THE CUSTOMER.

CAUTION : Regular type resistors and capacitors are not listed. To know those values, refer to the schematic diagram. Regular type resistors are less than 1/4 W carbon type and 0 ohm chip resistors. Regular type capacitors are less than 50 V and less than 1000 μF type of Ceramic type and Electrical type.

N.S.P : Not available as service parts.

PACKING & ACCESSORIES

REF.NO.	PART NO.	DESCRIPTION	REF.NO.	PART NO.	DESCRIPTION
	614 329 2753	CARTON CASE, OUTER	Y02	411 030 0500	SCR TPG PAN PCS 1.7X4, SPEAKER
	614 329 4054	CARTON CASE, INNER			
	614 329 4078	INSTRUCTION MANUAL			
	645 059 4878	CABLE, USB			

CABINET & CHASSIS

REF.NO.	PART NO.	DESCRIPTION
1	614 329 3958	ASSY, DEC, LCD
2	614 329 2623	CABINET, FRONT
3	614 328 3379	BUTTON, VOL
4	614 328 3522	HOLDER, LCD
5	614 328 3669	TERMINAL, BATTERY, (+, -)
6	614 328 3386	BUTTON, PLAY
7	614 328 3430	COVER, USB
8	614 328 3539	KNOB, SLIDE
9	614 328 3560	SPACER, MIC
10	614 329 3965	CABINET
11	614 328 3492	HOLDER, SPEAKER
12	614 329 4009	LID, BATTERY
13	614 329 4801	ASSY, CABINET, REAR
14	614 328 3478	DEC, STAND
15	614 328 3621	SHAFT, CLIP
16	614 328 3638	SPRING, WIRE, CLIP
17	614 328 3454	DEC, REAR
18	614 328 3485	HOLDER, CLIP

FIXING PARTS

REF.NO.	PART NO.	DESCRIPTION
Y01	411 184 5109	SCR TPG PAN PCS 1.7X8, REAR-FRONT

ELECTRICAL PARTS

REF.NO.	PART NO.	DESCRIPTION
51	645 063 7216	LCD
52	645 063 7223	MICROPHONE
53	645 063 1481	SPEAKER, 8

LCD P.W.BOARD ASSY

REF.NO.	PART NO.	DESCRIPTION
71	614 328 3225	ASSY PWB, LCD (Only initial)
AM401	614 328 3645	TERMINAL, BATTERY, BATT+
AM402	614 328 3652	TERMINAL, BATTERY, BATT-
CN451	645 063 1436	JACK, PHONE D3.6
S4601	645 040 1978	SWITCH, PUSH 1P-1T
S4604	645 040 1978	SWITCH, PUSH 1P-1T
S4605	645 040 1978	SWITCH, PUSH 1P-1T
S4613	645 032 7421	SWITCH, SLIDE 1P-2T
S4615	645 040 1978	SWITCH, PUSH 1P-1T

MAIN P.W.BOARD ASSY

REF.NO.	PART NO.	DESCRIPTION
72	614 328 3218	ASSY PWB, MAIN (Only initial)
CN411	645 053 8421	SOCKET, USB
CN421	645 053 9053	JACK, PHONE D3.6

WIRING DIAGRAM (LCD) Pattern Side View

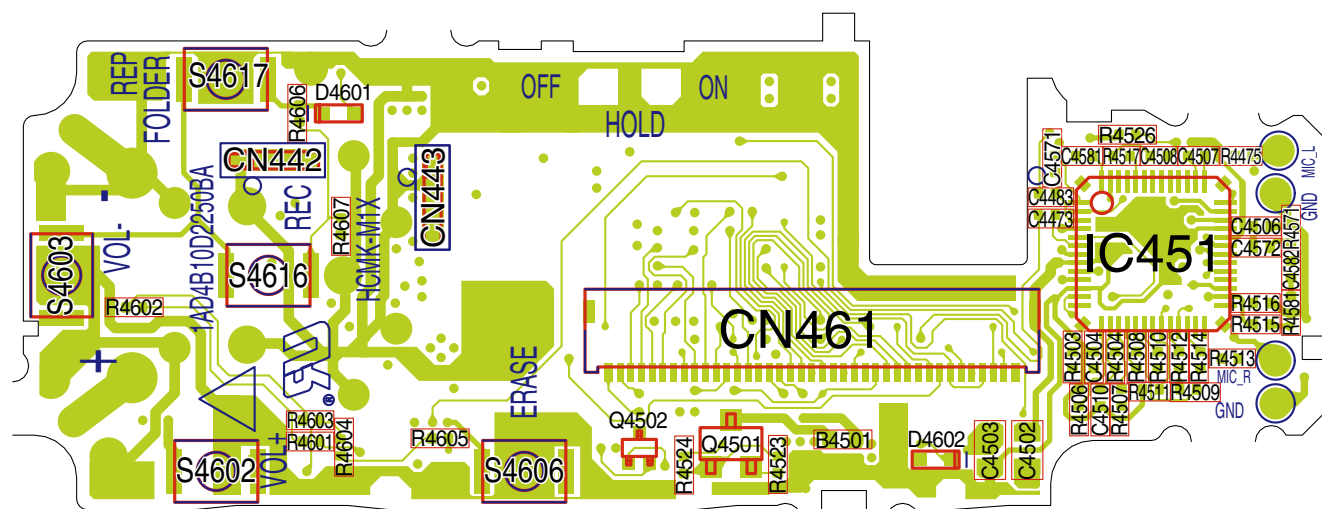

This is a basic wiring diagram.

WIRING DIAGRAM (LCD, MAIN)

(LCD) Parts Side View

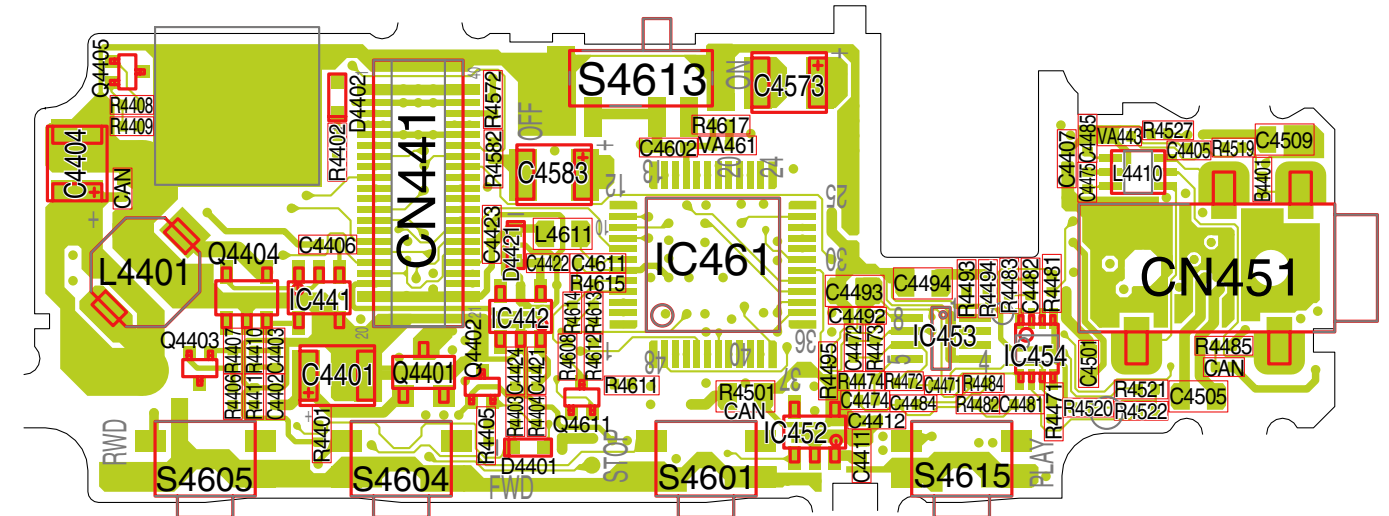

(MAIN) Pattern Side View

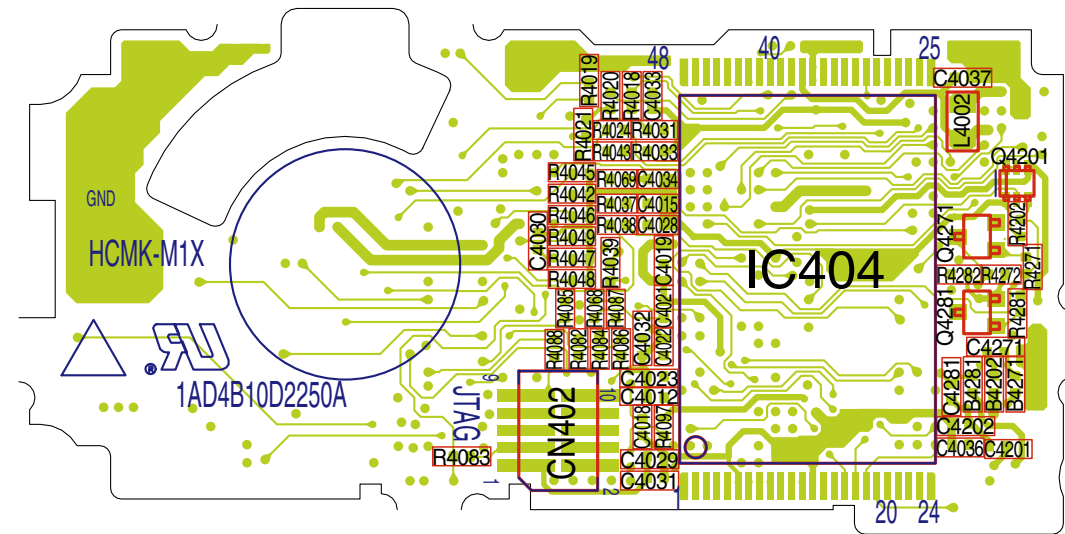

(MAIN) Parts Side View

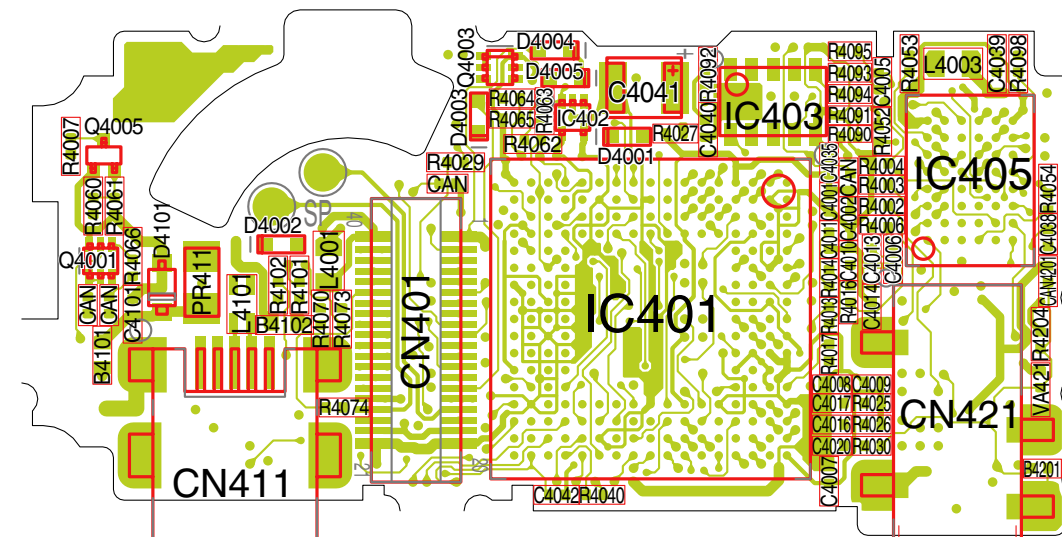

This is a basic wiring diagram.

SCHEMATIC DIAGRAM (FRONT)

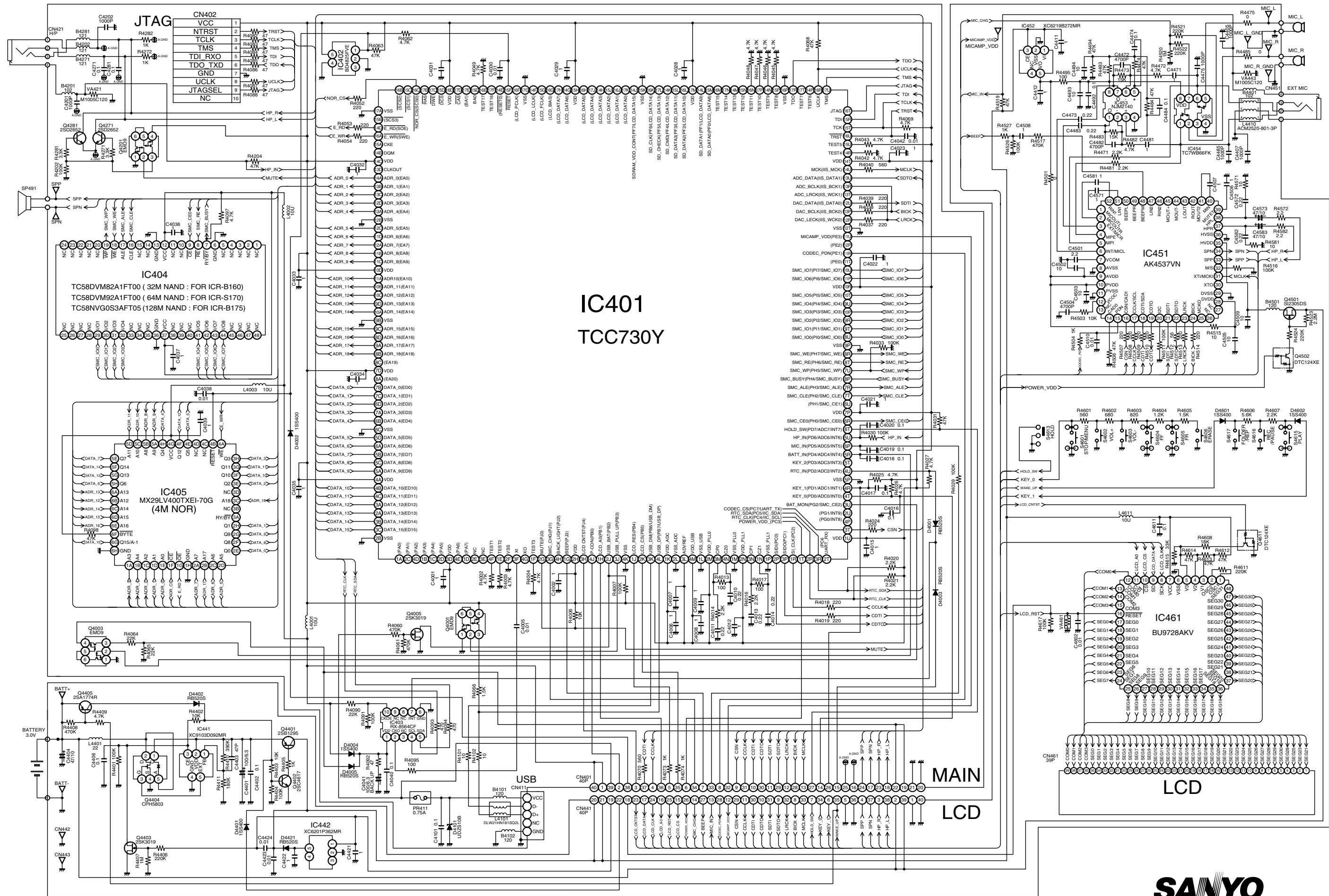

This is a basic schematic diagram.

