

JVC

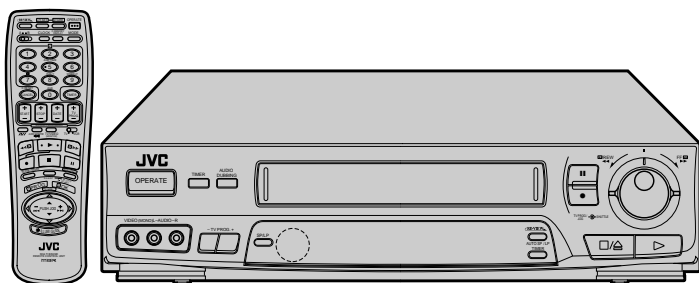

VIDEO CASSETTE RECORDER

HR-J635EK



VIDEO *Plus+*

Hi-Fi **VHS**
PAL

INSTRUCTIONS

CONTENTS

SAFETY FIRST	2
Safety Precautions	2
Some Do's And Don't's	3
INSTALLING YOUR NEW RECORDER	4
Basic Connections	4
Tune The TV To Your Video Recorder	5
Connection To A Satellite Receiver	6
Connection To A Stereo System	7
INITIAL SETTINGS	8
Tuner Set	8
Clock Set	9
PLAYBACK	11
Basic Playback	11
Playback Features	12
RECORDING	20
Basic Recording	20
B.E.S.T. Picture System	21
On-Screen Displays	23
Recording Features	24
TIMER RECORDING	26
Information On Video Plus+	26
Guide Channel Set	26
Video Plus+ Timer Recording	28
Regular Timer Programming	30
Check And Cancel Programmes	32
Timer Warning	32
Auto SP/LP Timer	33
PDC Recording	33
EDITING	34
Edit To Or From Another Video Recorder	34
Edit From A Camcorder	35
Random Assemble Editing	36
Audio Dubbing	38
REMOTE CONTROL	40
Multi-Brand Remote Control	40
USING THE CONFIRMATION SCREEN	41
Storing Channels Manually	41
Delete A Channel	42
Change Station Preset Position	42
Set Stations	43
TV STATION AND ID LIST	45
TV STATION CHANNEL NUMBER GUIDE	46
TROUBLESHOOTING	47
QUESTIONS AND ANSWERS	49
INDEX	50
SPECIFICATIONS	55

Safety Precautions

The rating plate and the safety caution are on the rear of the unit.

WARNING: DANGEROUS VOLTAGE INSIDE

WARNING: TO PREVENT FIRE OR SHOCK HAZARD, DO NOT EXPOSE THIS UNIT TO RAIN OR MOISTURE.

IMPORTANT

Connection to the mains supply in the United Kingdom. DO NOT cut off the mains plug from this equipment. If the plug fitted is not suitable for the power points in your home or the cable is too short to reach a power point, then obtain a proper safety approved extension lead/adaptor or consult your dealer.

BE SURE to replace the fuse only with an identical approved type, as originally fitted, and to replace the fuse cover.

If nonetheless the mains plug is cut off remove the fuse and dispose of the plug immediately, to avoid a possible shock hazard by inadvertent connection to the mains supply. If this product is not supplied fitted with a mains plug then follow the instructions given below:

DO NOT make any connection to the Larger Terminal coded E or Green.

The wires in the mains lead are coloured in accordance with the following code:

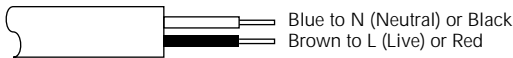

If these colours do not correspond with the terminal identifications of your plug, connect as follows:
Blue wire to terminal coded N (Neutral) or coloured Black.
Brown wire to terminal coded L (Live) or coloured Red.

If in doubt — consult a competent electrician.

CAUTION

- When you are not using the recorder for a long period of time, it is recommended that you disconnect the power cord from the mains outlet.
- Dangerous voltage inside. Refer internal servicing to qualified service personnel. To prevent electric shock or fire hazard, remove the power cord from the mains outlet prior to connecting or disconnecting any signal lead or aerial.

IMPORTANT

- Please read the various precautions on p. 2 – 3 of this instruction manual before installing or operating the recorder.
- It should be noted that it may be unlawful to re-record pre-recorded tapes, records, or discs without the consent of the owner of copyright in the sound or video recording, broadcast or cable programme and in any literary, dramatic, musical, or artistic work embodied therein.

The OPERATE button does not completely shut off mains power from the unit, but switches operating current on and off.

Video tapes recorded with this video recorder in the LP (Long Play) mode cannot be played back on a single-speed video recorder.

Failure to heed the following precautions may result in damage to the recorder, remote control or video cassette.

1. **DO NOT** place the recorder . . .
 - ... in an environment prone to extreme temperatures or humidity.
 - ... in direct sunlight.
 - ... in a dusty environment.
 - ... in an environment where strong magnetic fields are generated.
 - ... on a surface that is unstable or subject to vibration.
2. **DO NOT** block the recorder's ventilation openings.
3. **DO NOT** place heavy objects on the recorder or remote control.
4. **DO NOT** place anything which might spill on top of the recorder or remote control.
5. **AVOID** violent shocks to the recorder during transport.

MOISTURE CONDENSATION

Moisture in the air will condense on the recorder when you move it from a cold place to a warm place, or under extremely humid conditions—just as water droplets form in the surface of a glass filled with cold liquid. Moisture condensation on the head drum will cause damage to the tape. In conditions where condensation may occur, keep the recorder turned on for a few hours to let the moisture dry.

ABOUT HEAD CLEANING

Accumulation of dirt and other particles on the video heads may cause the playback picture to become blurred or interrupted. Be sure to contact your nearest JVC dealer if such troubles occur.



- Only cassettes marked "VHS" can be used with this videorecorder.
- HQ VHS is compatible with existing VHS equipment.
- Video Plus+ and PlusCode are trademarks of Gemstar Development Corporation. The Video Plus+ system is manufactured under licence from Gemstar Development Corporation.

4-STEP QUICK SET UP

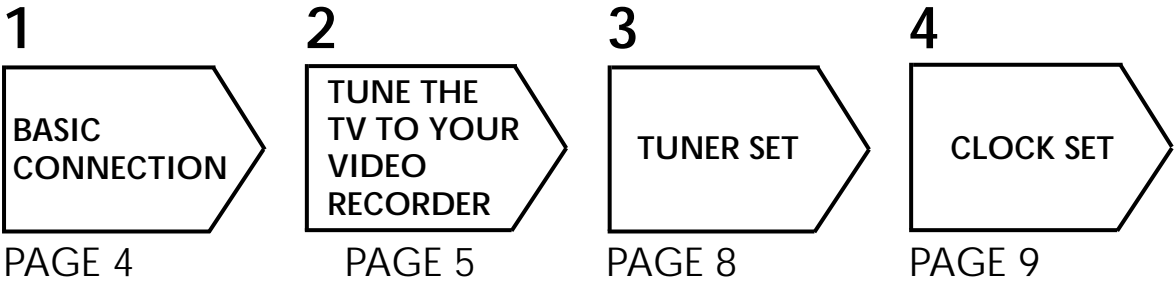

Some Do's And Don'ts On The Safe Use Of Equipment

This equipment has been designed and manufactured to meet international safety standards but, like any electrical equipment, care must be taken if you are to obtain the best results and safety is to be assured.

- DO** read the operating instructions before you attempt to use the equipment.
- DO** ensure that all electrical connections (including the mains plug, extension leads and interconnections between pieces of equipment) are properly made and in accordance with the manufacturer's instructions. Switch off and withdraw the mains plug when making or changing connections.
- DO** consult your dealer if you are ever in doubt about the installation, operation or safety of your equipment.
- DO** be careful with glass panels or doors on equipment.
- DON'T** continue to operate the equipment if you are in any doubt about it working normally, or if it is damaged in any way — switch off, withdraw the mains plug and consult your dealer.
- DON'T** remove any fixed cover as this may expose dangerous voltages.
- DON'T** leave equipment switched on when it is unattended unless it is specifically stated that it is designed for unattended operation or has a standby mode. Switch off using the switch on the equipment and make sure that your family knows how to do this. Special arrangements may need to be made for infirm or handicapped people.
- DON'T** use equipment such as personal stereos or radios so that you are distracted from the requirements of road safety. It is illegal to watch television whilst driving.
- DON'T** listen to headphones at high volume, as such use can permanently damage your hearing.
- DON'T** obstruct the ventilation of the equipment, for example with curtains or soft furnishings. Overheating will cause damage and shorten the life of the equipment.
- DON'T** use makeshift stands and NEVER fix legs with wood screws — to ensure complete safety always fit the manufacturer's approved stand or legs with the fixings provided according to the instructions.
- DON'T** allow electrical equipment to be exposed to rain or moisture.

ABOVE ALL...

- **NEVER** let anyone especially children push anything into holes, slots or any other opening in the case — this could result in a fatal electrical shock;
- **NEVER** guess or take chances with electrical equipment of any kind — it is better to be safe than sorry!

Basic Connections

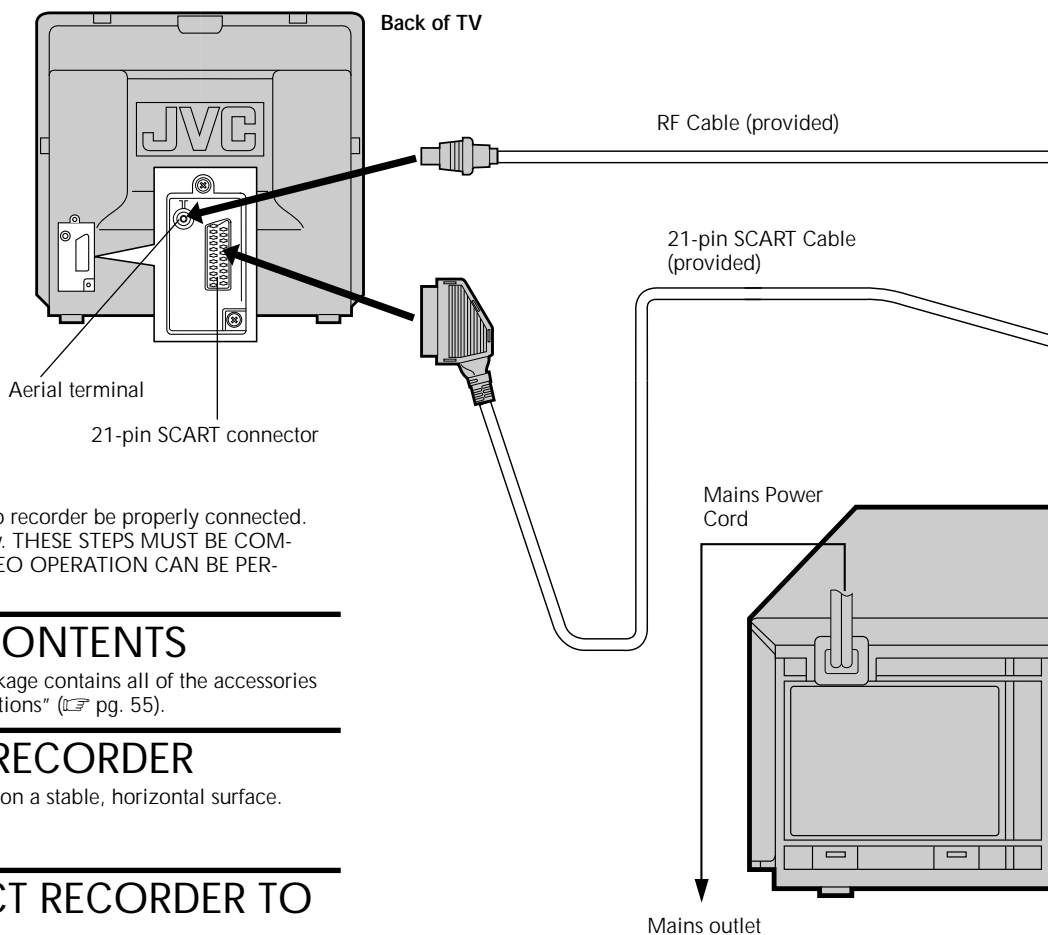

It's essential that your video recorder be properly connected. Follow these steps carefully. THESE STEPS MUST BE COMPLETED BEFORE ANY VIDEO OPERATION CAN BE PERFORMED.

1 CHECK CONTENTS

Make sure the package contains all of the accessories listed in "Specifications" (pg. 55).

2 SITUATE RECORDER

Place the recorder on a stable, horizontal surface.

3 CONNECT RECORDER TO TV

The connection method you use depends on the type of TV you have.

RF CONNECTION

- *To Connect To A TV With NO AV Input Terminals . . .*
 - a- Disconnect the TV aerial cable from the TV.
 - b- Connect the TV aerial cable to the ANT. IN jack on the rear panel of the recorder.
 - c- Connect the provided RF cable between the RF OUT jack on the rear panel of the recorder and the TV's aerial terminal.

Before operating the recorder, make sure the TV's preset is set to the VIDEO preset.

AV CONNECTION

- *To Connect To A TV With AV Input Terminals . . .*
 - a- Connect the aerial, recorder and TV as per "RF CONNECTION".
 - b- Connect the provided SCART cable between the AV1 IN/OUT socket on the rear panel of the recorder and the TV's 21-pin SCART connector.
 - c- Set the RF OUT switch to OFF.

Before operating the recorder, make sure the TV is set to the VIDEO (or AV) mode.

4 CONNECT RECORDER TO MAINS

Plug the end of the mains power cord into a mains outlet.

Tune The TV To Your Video Recorder

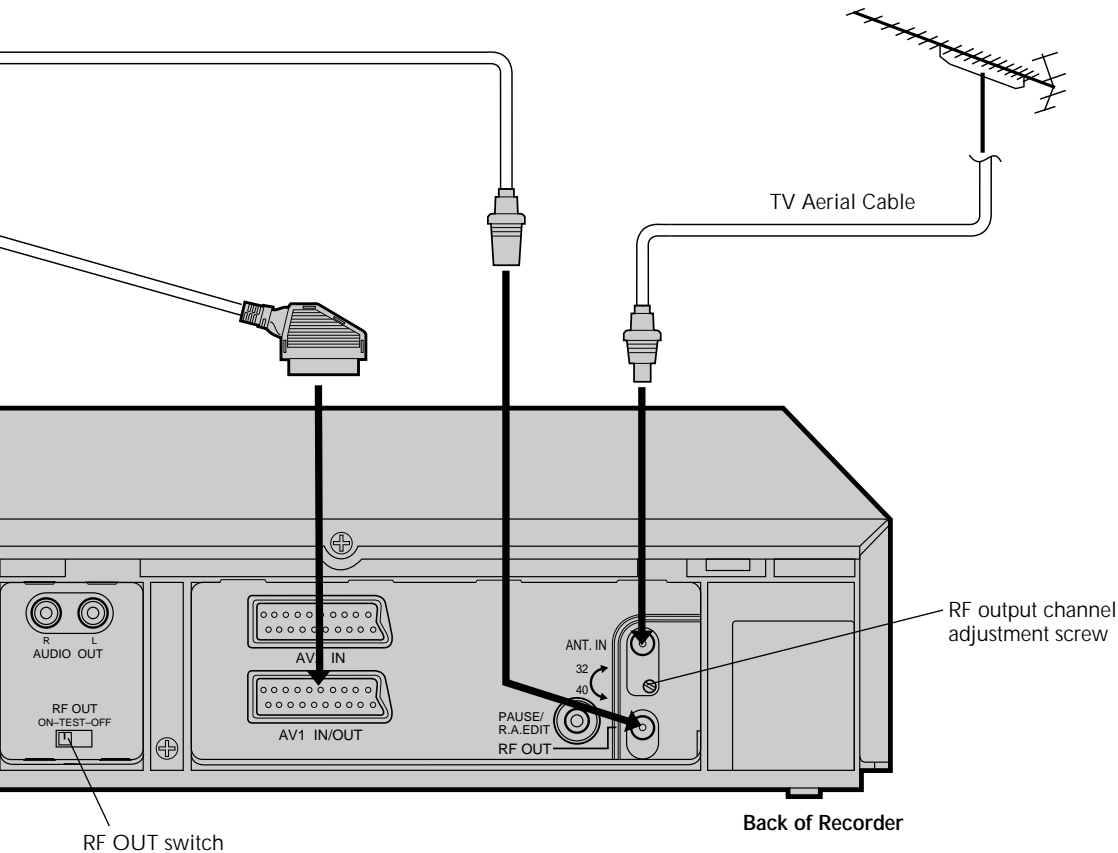

The video recorder sends picture and sound signals via the RF connecting cable to your TV on UHF channel 36.

* If you have connected the video recorder to your TV via both the provided RF cable and 21-pin SCART cable, you can ignore the rest of the following steps.

1

TURN ON THE RECORDER

Press **OPERATE**.

2

SELECT OUTPUT MODE

Set the **RF OUT** switch on the back of the recorder to **TEST**.

3

SET TV PRESET

Set your TV to the video preset (UHF channel 36). Two white bars appear on screen vertically.

- Tune the TV until the bars are as clear as they can be.
- Your TV should be set to the preset designated for use with a video recorder, or to a spare preset if there is not a specified video preset on your TV.

4

RESET OUTPUT MODE

Return the **RF OUT** switch to **ON**.

NOTE:

If some interference noise is continually seen on the screen, consult your JVC dealer.

The AV2 IN socket on the rear panel of your recorder allows simple connection to a satellite receiver.

Connection To A Satellite Receiver

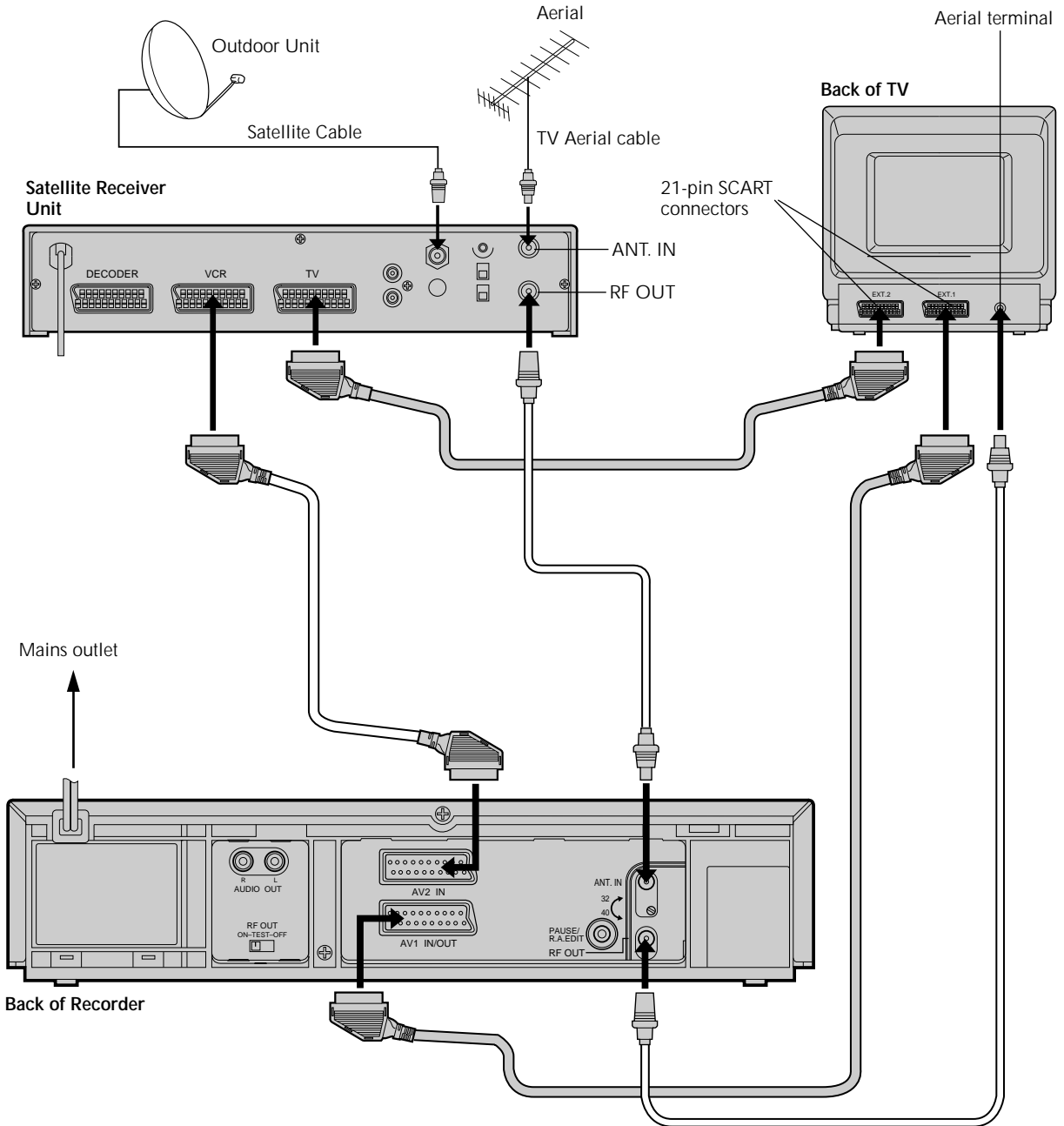

NOTES:

- When connecting your recorder to a TV equipped with 21-pin SCART connectors, follow the illustration above using the cables shown in gray.
- For details, check your satellite receiver's instruction manual.

Connection To A Stereo System

These instructions enable you to connect your video recorder to your Hi-Fi stereo system (if you have one) and listen to the soundtrack through the stereo.

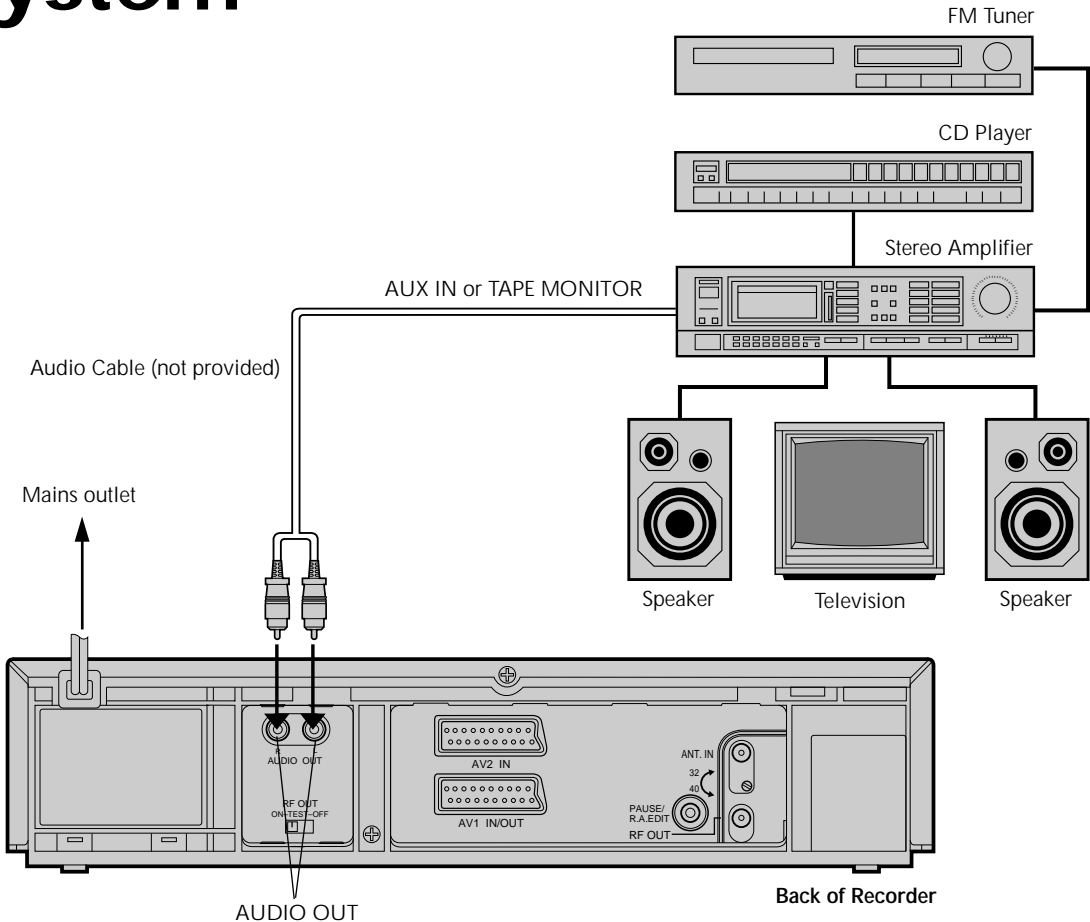

1 MAKE CONNECTIONS

Connect the AUDIO OUT L and R connectors on your video recorder to the AUX IN or TAPE MONITOR terminals on your stereo system's receiver or amplifier.

NOTES:

- When connecting your recorder's audio output connectors to a stereo amplifier, make sure you connect L and R correctly.
- If NICAM TV broadcasts are receivable in your area, this recorder can record them independently of the TV set and play them back through the connected stereo system.
- When listening to sound through the connected stereo system, turn the TV's volume down completely.

CAUTIONS:

- This recorder has a dynamic range of more than 80 dB with regards to its Hi-Fi audio capability. It is recommended that you check the maximum level if you are going to listen to the Hi-Fi audio signals through a stereo amplifier. A sudden surge in the input level to the speakers may damage them.
- Some speakers and televisions are specially shielded to prevent television interference. If both are of the non-shielded type, do not place the speakers adjacent to the TV set as this can adversely affect the video playback picture.

Tuner Set

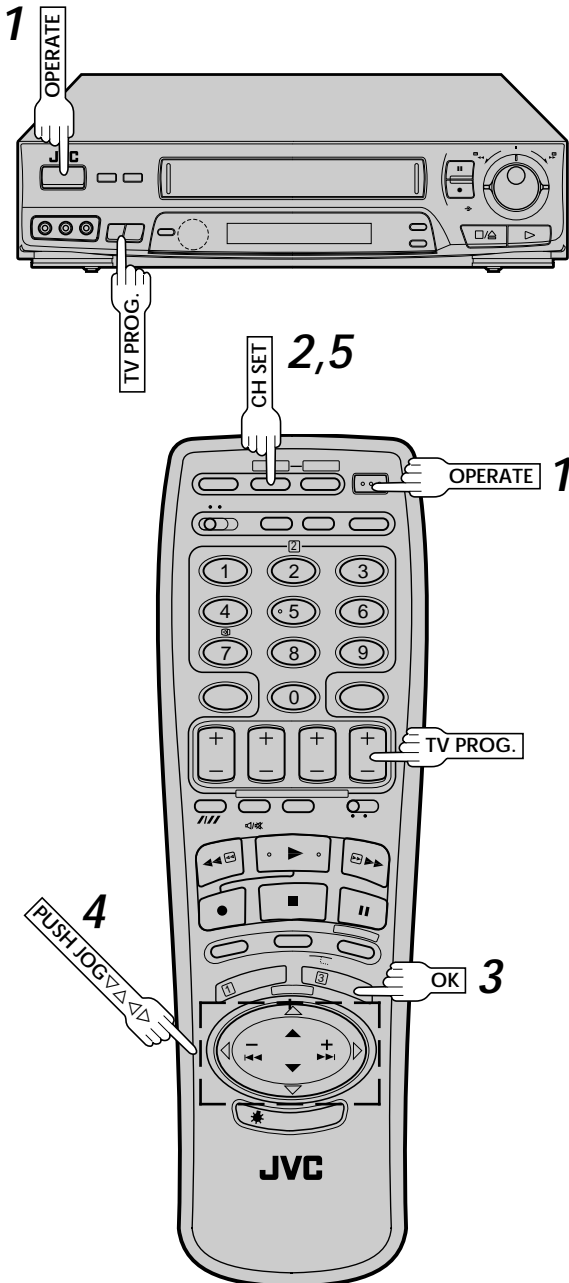

NOTES:

- Fine tuning is performed automatically when you select "AUTO CH SET". If you want to perform it manually, refer to page 44.
- To set the tuner manually, refer to "Storing Channels Manually" (pg. 41).

Your recorder needs to memorise all necessary stations in preset positions in order to record TV programmes. ATS+ (Auto Tuning System) automatically assigns all receivable stations in your area to call them up with the **TV PROG.** buttons without going through any vacant channels.

The following procedure describes how to select automatic channel setting.

1 TURN ON THE RECORDER

Press **OPERATE**.

2 ACCESS CH SET MODE MENU

Press and hold **CH SET** for more than 2 seconds. The Ch. Set Mode menu screen to the right appears.

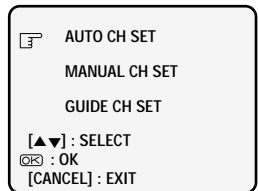

3 SELECT MODE

"AUTO CH SET" is the necessary mode for this procedure, so simply press **OK** to enter the selection.

- The Auto Ch. Set screen appears, and remains on screen while the recorder searches for receivable stations.



4 VIEW CONFIRMATION SCREEN

The stations your recorder located appear on a Confirmation screen — preset positions (PR), presets (CH) and station names (ID — pg. 45). To view the next page of the listing, press **PUSH JOG**. The blueback screen and the program currently being broadcast by the highlighted station appear alternately for 5 seconds each.

PR	CH	ID	PR	CH	ID
01	40	BBC1	08	----	----
02	46	BBC2	09	----	----
03	43	ITV	10	----	----
04	65	CH4	11	----	----
05	----	----	12	----	----
06	----	----	13	----	----
07	----	----	14	----	----

[▲▼▶◀]: SELECT
[CANCEL]: DELETE
[OK]: EDIT
[CH SET]: EXIT

5 RETURN TO NORMAL SCREEN

Press **CH SET**.

- Using the Confirmation screen, you can skip or add preset positions, enter station names and perform other operations. Refer to page 41 for the procedures.
- Depending on reception conditions, the stations may not be stored in order, and the station names may not be stored correctly.

Clock Set

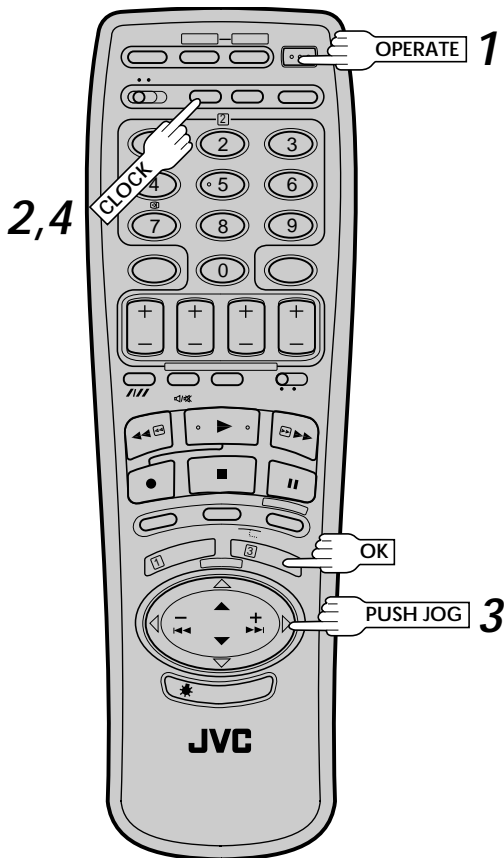
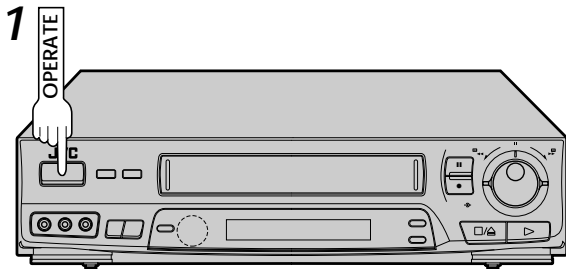

If you performed Auto Channel Set (pg. 8), the recorder's built-in clock is also set automatically. The Auto and Manual clock setting procedures are necessary when . . .

- a power outage of more than 3 minutes occurs.
- the tuner has been set manually.
- the user desires to set the clock slightly ahead of the actual time.
- the clock was not set even after Auto Tuner Set was performed.

Whether you perform Auto or Manual clock setting, you can use the convenient Just Clock function.

Just Clock

The Just Clock function provides accurate time keeping through automatic adjustments at regular intervals, by reading data from a PDC signal.

The Just Clock option appears in the Clock Set and Auto Clock Set screens, and can be set "ON" or "OFF" (the default setting is "ON"). Press **OK** until the Just Clock setting begins blinking, then press **PUSH JOG** to change the setting.

IMPORTANT: If you turn off Just Clock off, the accuracy of your recorder's built-in clock may be reduced, which could adversely effect timer recording.

Both Auto and Manual clock setting procedures begin from step 3.

Preparation

1 TURN THE RECORDER ON

Press **OPERATE**.

2 ACCESS CLOCK SET SCREEN

Press **CLOCK** on the remote control. The Clock Set screen appears.

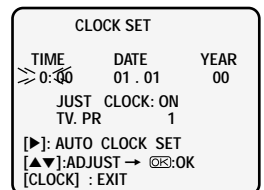

Auto Clock Set

3 SET CLOCK AUTOMATICALLY

At the Clock Set screen, press **PUSH JOG**. The Auto Clock Set screen appears and clock setting begins.

- If "TV.PR" isn't set to the preset position on which Auto Clock Set data is received, "ERROR" appears, and then the screen from step 2 reappears. To set "TV.PR", press **OK** to place the cursor next to it, then cycle through the numbers by pressing **PUSH JOG** until the number representing the position in which the station transmitting clock setting data (BBC1, BBC2, etc.) is stored appears.

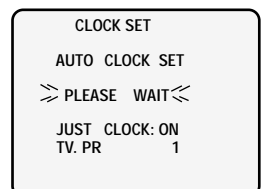

CONTINUED ON NEXT PAGE.

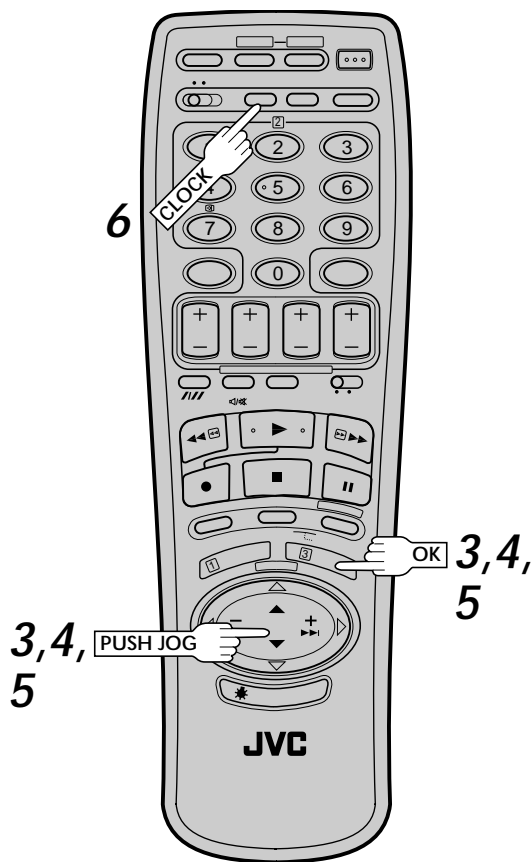
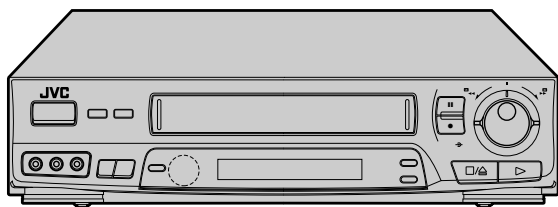

4 RETURN TO NORMAL SCREEN

Once clock setting is completed, press **CLOCK** to return to the normal screen.

Manual Clock Set

3 SET DATE AND TIME

Press **PUSH JOG** to set the hour, then press **OK**. The "minutes" display begins blinking. Repeat the procedure to set the minutes, day, month and year.

4 SET JUST CLOCK

The default setting is "ON". Set as desired by pressing **PUSH JOG**, then press **OK**.

- If you set to "OFF", you can disregard the next step as you won't be able to receive regular clock adjustments.

5 SET CLOCK DATA SOURCE PRESET

The recorder is preset to receive clock setting and adjustment data from preset position 1. Press **PUSH JOG** to set the preset position to the number representing the station transmitting clock setting data (BBC1, BBC2, etc.), then press **OK**.

6 START CLOCK OPERATION

Press **CLOCK**.

NOTES:

- *Just Clock* (when set to "ON") enables adjustment of the recorder's built-in clock every hour on the hour, except for 11 o'clock in the evening and midnight.
- *Just Clock* is not effective when . . .
 - the recorder's power is on (unless the recorder is tuned to the same preset selected in the Clock Set screen).
 - the recorder is in the Timer mode.
 - a difference of more than 3 minutes exists between the built-in clock's time and the actual time.
- The recorder's clock is automatically adjusted at the start/end of Summer Time.
- Auto clock setting and Just Clock may not function properly depending on the reception condition.
- During Manual clock setting, if the day and month data are invalid (such as 31st April), the month digits are cleared automatically and the day digits begin blinking. Input the correct data.
- If, in step 3 of the Manual clock setting procedure, the year digits are automatically cleared and the day digits begin blinking, it is possible that you have input 29th February for a non-leap year. Input the correct data.

Basic Playback

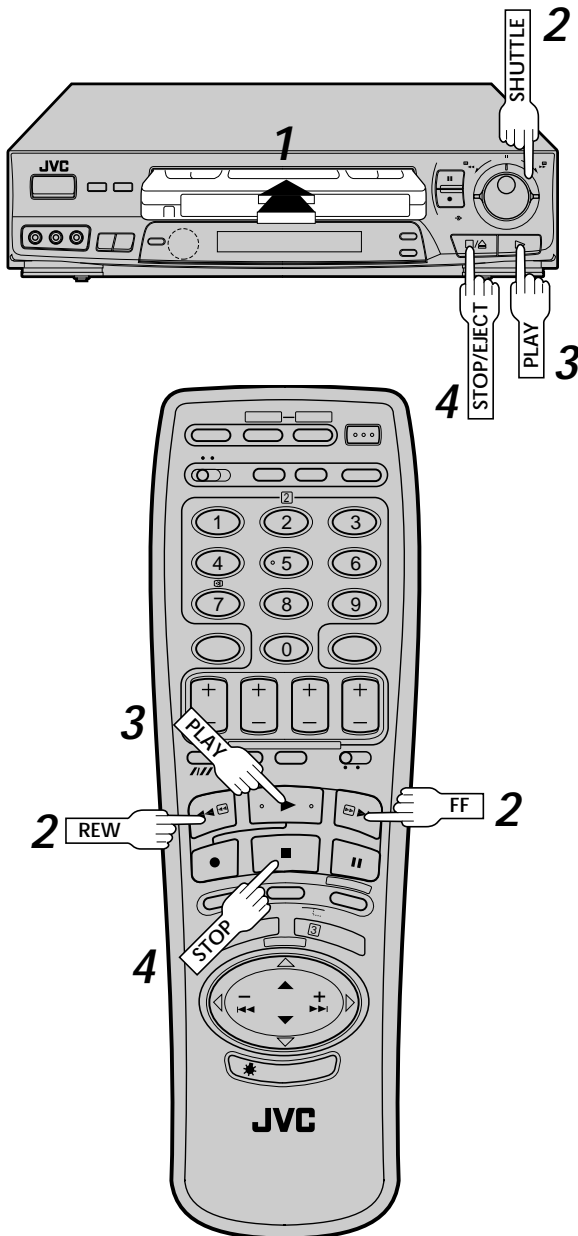

The easiest, most basic operation possible with your video recorder is tape playback. Already-recorded signals on a video tape are read by your video recorder and displayed on your TV just like a TV programme.

1 LOAD A CASSETTE

Make sure the window side is up, the rear label side is facing you and the arrow on the front of the cassette is point toward the recorder. Don't apply too much pressure when inserting.

- The recorder power comes on automatically and the counter is reset to 0:00:00.
- If the record safety tab has been removed, playback begins automatically.

2 FIND PROGRAMME START POINT

If the tape is advanced past the start point, press **REW** or turn the **SHUTTLE** ring to the left and release it. To go forward, press **FF** or turn the **SHUTTLE** ring to the right and release it.

3 START PLAYBACK

Press **PLAY**. "BEST" appears blinking in the recorder's display panel for 5 seconds (see pg. 22).

- Playback picture quality of LP recordings will not be as high as SP recordings.

4 STOP PLAYBACK

Press **STOP** on the remote or **STOP/EJECT** on the recorder's front panel. Then press **STOP/EJECT** to remove the cassette.

Usable cassettes

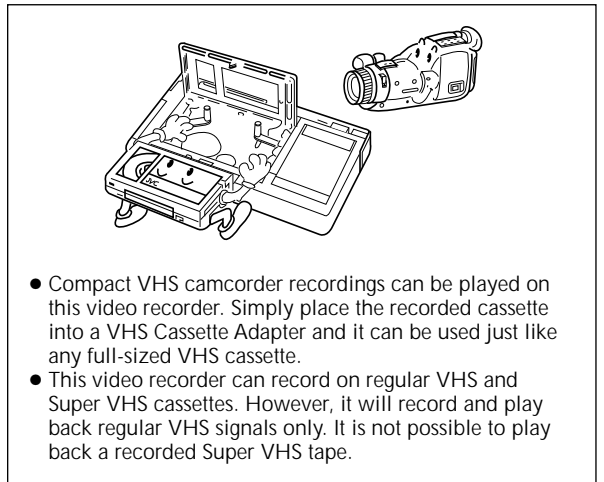

- Compact VHS camcorder recordings can be played on this video recorder. Simply place the recorded cassette into a VHS Cassette Adapter and it can be used just like any full-sized VHS cassette.
- This video recorder can record on regular VHS and Super VHS cassettes. However, it will record and play back regular VHS signals only. It is not possible to play back a recorded Super VHS tape.

Playback Features

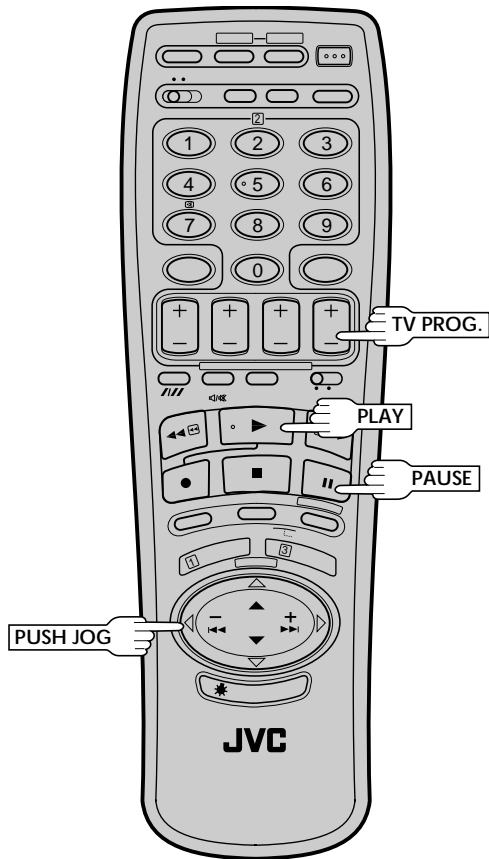
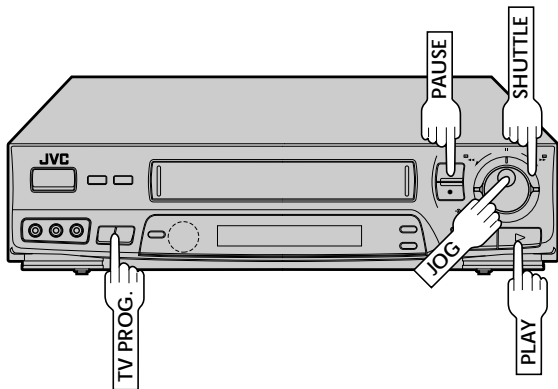

Take advantage of special functions possible with the recorder's controls or the remote control.

NOTE:

Refer to the **SHUTTLE** ring illustration below as you read the following procedures.

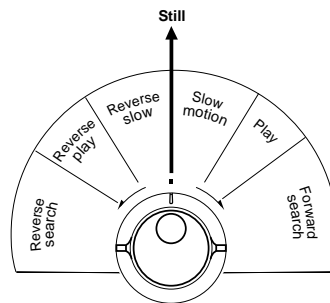

Still Picture/Frame-By-Frame Playback

1 PAUSE DURING PLAYBACK

Press **PAUSE**. If there is vertical jitter, use the **TV PROG.** buttons to correct the picture.

2 ACTIVATE FRAME-BY-FRAME PLAYBACK

Turn the **JOG** dial to the right for forward frame-by-frame playback, or to the left for reverse frame-by-frame playback.

OR

Press **PAUSE**.

OR

Press **PUSH JOG** ◀ or ▶.

To resume normal playback, press **PLAY**.

Slow Motion

1 ACTIVATE SLOW-MOTION PLAYBACK

During playback or still, turn the **SHUTTLE** ring to the right for forward slow motion, or to the left for reverse slow motion (refer to the illustration above).

OR

During still picture, press **PAUSE** and hold for 2 seconds, then release. Press and release again to return to still picture.

OR

During still picture, press and hold **PUSH JOG** ◀ or ▶. Release to return to still picture.

To resume normal playback, press **PLAY**.

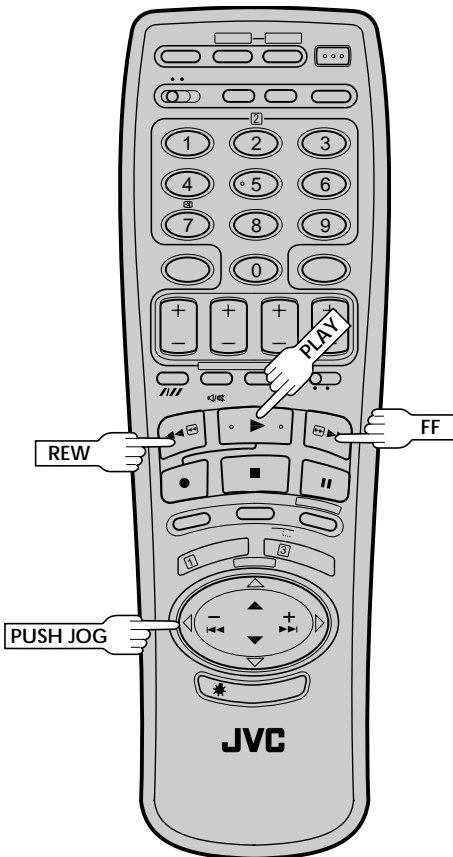
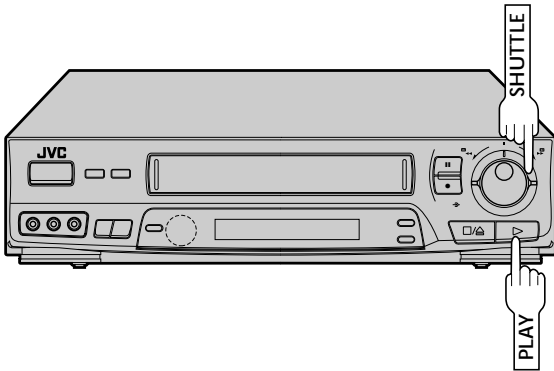

Variable-Speed Search

1 ACTIVATE VARIABLE-SPEED SEARCH

During playback or still, turn the **SHUTTLE** ring to the right for forward variable-speed search, or to the left for reverse variable-speed search (refer to the illustration on page 12).

OR

During playback, press **PUSH JOG** ◀ or ▶.

- The more times you press, the faster the playback picture moves.
- To decrease speed, press the button for the opposite direction.

To resume normal playback, press **PLAY**.

High-Speed (Turbo) Search

1 ACTIVATE HIGH-SPEED SEARCH

During playback or still, turn the **SHUTTLE** ring all the way to the right for forward high-speed search, or to the left for reverse high-speed search.

- For forward search with a visible picture, turn the **SHUTTLE** ring all the way to the right and release it within 1 second.
- For reverse search with a visible picture, turn the **SHUTTLE** ring all the way to the left and release it within 1 second.

OR

Press **FF** for forward high-speed search, or **REW** for reverse high-speed search.

- For short searches, press and hold **FF** or **REW** for over 2 seconds. When released, normal playback resumes.

To resume normal playback, press **PLAY**.

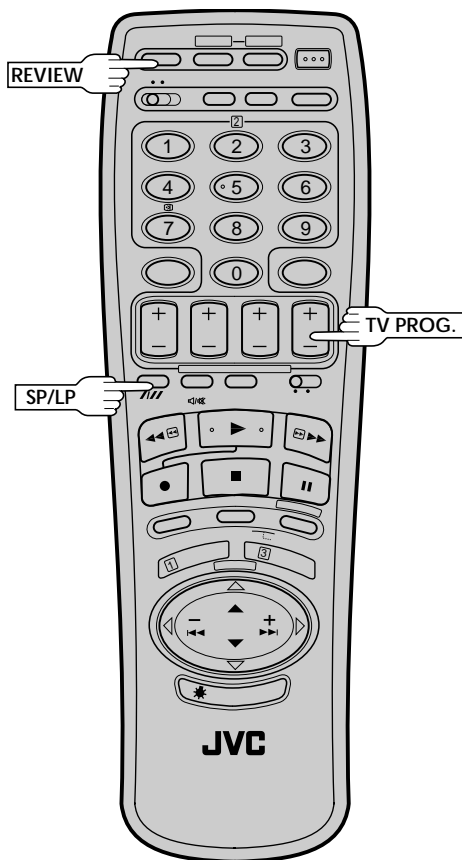
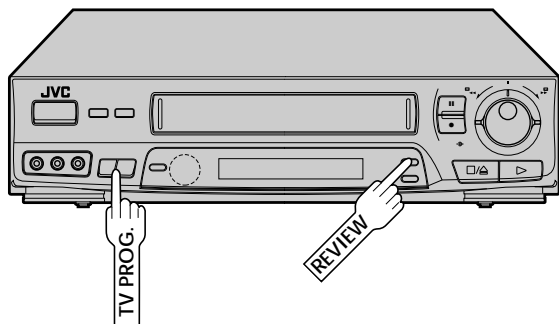

Manual Tracking

Your video recorder is equipped with automatic tracking control. During playback, you can override this and adjust the tracking manually by pressing the **TV PROG.** buttons.

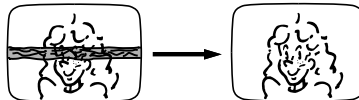

1 OVERRIDE AUTOMATIC TRACKING

Press **SP/LP** on the remote to engage manual tracking.

2 ADJUST TRACKING MANUALLY

Press **TV PROG.** + or - to adjust tracking.

3 RETURN TO AUTOMATIC TRACKING

Press **SP/LP** on the remote to re-engage automatic tracking.

NOTE:

When a new tape is inserted, the recorder enters the automatic tracking mode automatically.

Instant ReView

Simply by pressing a single button, the recorder power comes on, rewinds, and begins playback of the last timer-recorded programme. If you have several programmes recorded, you can easily access any of them.

NOTE:

Before starting, make sure that the recorder is off and that the Timer mode is disengaged.

1 ACTIVATE INSTANT REVIEW

Press **REVIEW**. The recorder power comes on and the recorder searches for the index code indicating the start of the last timer-recorded programme. Once it's found, playback begins automatically.

The front display panel tells you how many programmes have been recorded. If you have, for example, 3 programmes, "REV 3" appears and blinks. To watch the first of the 3 programmes, press **REVIEW** three times. The recorder searches and begins playback automatically. You can access a programme as far as 9 index codes away from the current tape position.

NOTES:

- Instant ReView is not possible while the recorder is in the Timer mode.
- The number displayed on the front display panel may not match the actual number of timer-recorded programmes when one or more of them is a PDC recording (see pg. 33).

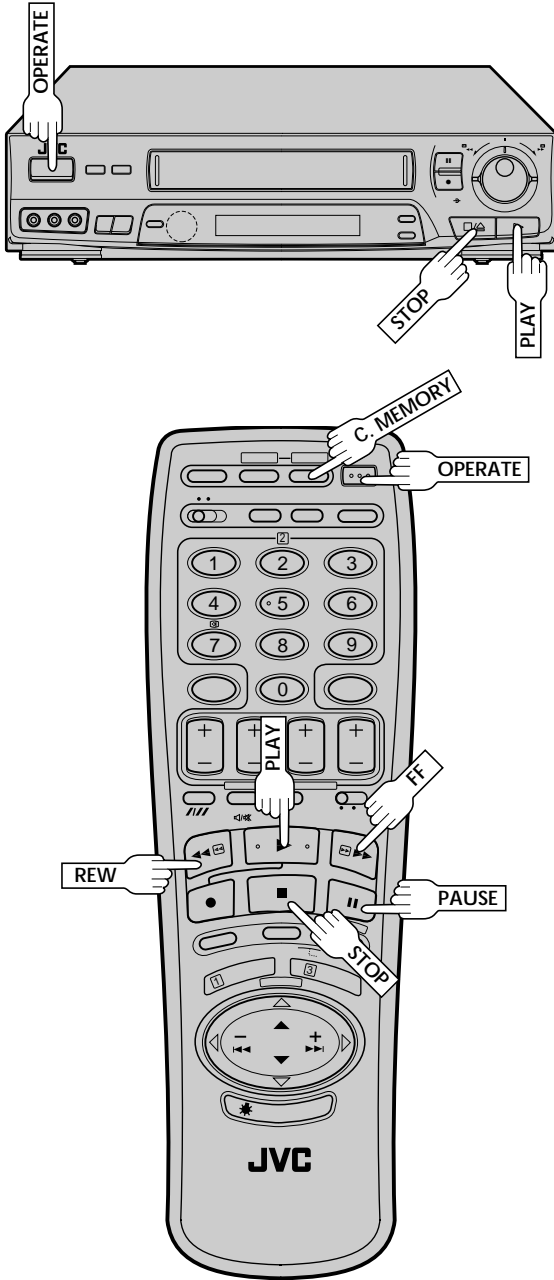

Repeat Playback

Your video recorder can automatically play back the whole tape 20 times repeatedly.



1 START PLAYBACK

Press **PLAY**.

2 ACTIVATE REPEAT PLAYBACK

Press **PLAY** and hold for over 5 seconds, then release.

- The Play indicator (▶) on the display panel blinks slowly.
- The tape plays 20 times automatically, and then stops.

3 STOP PLAYBACK

Press **STOP** at any time to stop playback.

NOTE:

Pressing **PLAY**, **REW**, **FF** or **PAUSE** also stops Repeat Playback.

Next Function Memory

You can set your recorder's power to go off automatically after the tape is fully rewound. Before starting, make sure the recorder is in the Stop mode.

For Automatic Power Off After Tape Rewind . . .
 . . . press **REW**, then press **OPERATE** within 2 seconds.

NOTE:

If you want the power to be turned off automatically when the counter reads "0:00:00" (instead of at the beginning of the tape), press **C.MEMORY** so that the "M" mark appears before pressing **REW**.

Tape Position Indicator

The tape position indicator appears on screen when, from the Stop mode, you press **FF**, **REW** or perform an Index Search. The position of "■" in relation to "0" (beginning) or "+" (end) shows you where you are on the tape.

"On-Screen" (pg. 23) must be set to "ON", or the indicator will not appear.

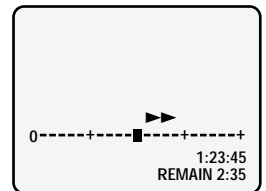

NOTE:

Depending on the type of tape used, there may be times when the indication is not correct.

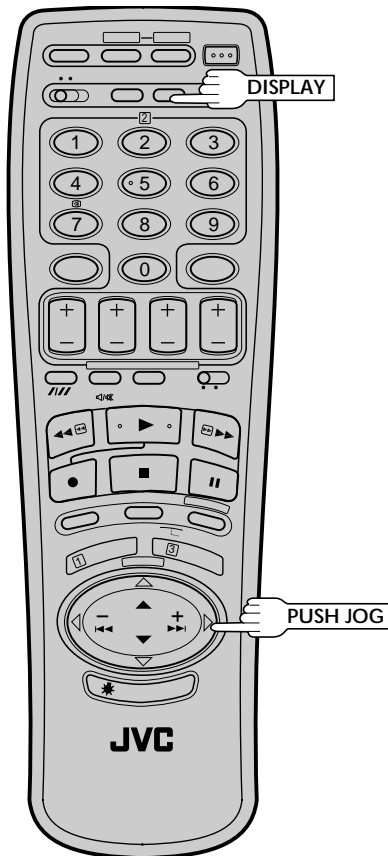
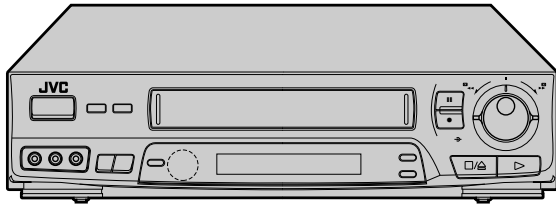

Index Search

Your recorder automatically marks index codes at the beginning of each recording. This function gives you quick access to any one of 9 index codes in either direction.



NOTE:

Before starting, make sure the recorder is in the Stop mode.

1 ACTIVATE INDEX SEARCH

Press **PUSH JOG** ◀ or ▶ (◀◀ or ▶▶). "◀◀ 1" or "▶▶ 1" is displayed on screen and search begins in the corresponding direction.

- To access index codes 2 through 9, press **PUSH JOG** ◀ or ▶ repeatedly until the correct index number is displayed.

Ex.: To locate the beginning of B from the current position, press **PUSH JOG** ◀ twice.

To locate the beginning of D from the current position, press **PUSH JOG** ▶ once.

Current position

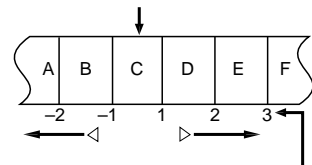

Index number

- When the specified index code is located, playback begins automatically.

Tape Remaining Time

1 DISPLAY REMAINING TIME

Press **DISPLAY** until the time remaining on the tape appears.

- By pressing the **DISPLAY** button, you can change the display to show the counter reading, tape remaining time, or clock time.

NOTE:

- Depending on the type of tape used, there may be times when the tape remaining time reading may not appear right away, or is not correct. "- : -" may sometimes appear, or the display may blink on occasion.

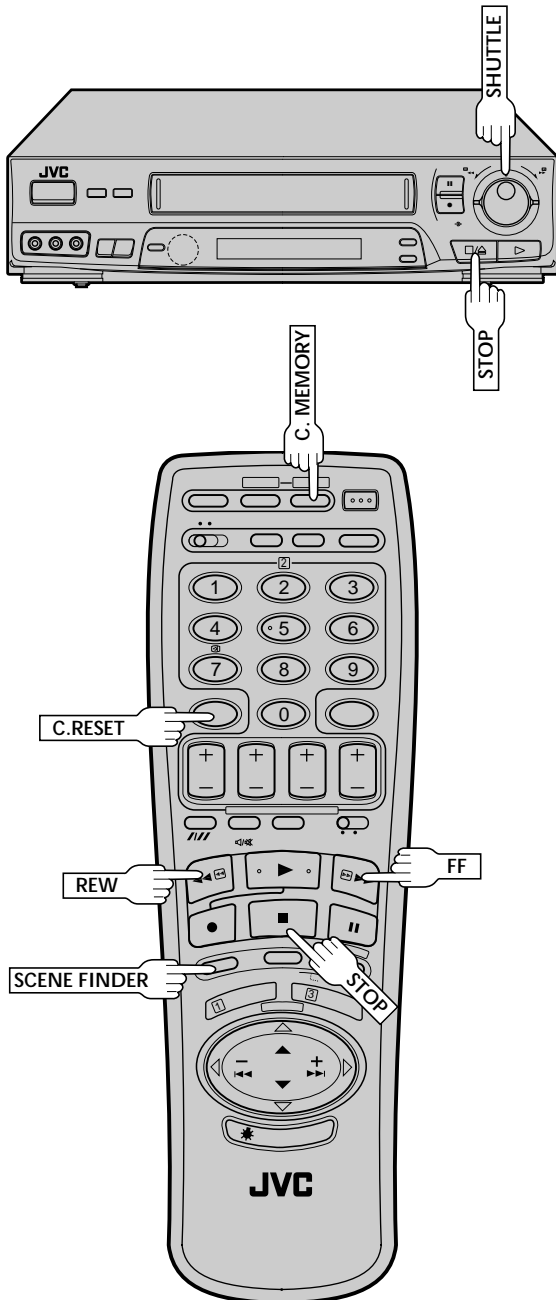

Scene Finder

This function helps you check contents of unlabeled recorded tapes at the touch of a single button.

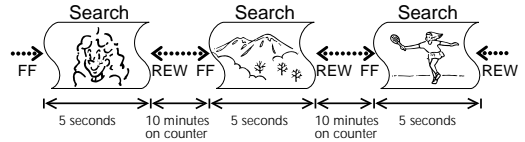

NOTE:

Scene Finder cannot be used when the recorder is in the Record mode.

1 ACTIVATE SCENE FINDER

Press **SCENE FINDER**. The recorder starts forward high-speed search for 5 seconds and then fast-forwards 10 minutes on the counter. This cycle is repeated until the end of the tape is reached.

- To start Scene Finder in the reverse direction, press **SCENE FINDER** and then turn the **SHUTTLE** ring to the left (or press the remote's **REW** button) within 2 seconds. This cycle is repeated until the beginning of the tape.
- During Scene Finder, the following indications appear on the display panel:



2 STOP SCENE FINDER

Press **STOP**.

NOTES:

- During Scene Finder high-speed search, you can also hear the tape sound. During fast forward or rewind, you hear the current TV sound instead.
- Scene Finder does not function during Index Search.

Counter Memory

Returns to the counter reading of "0:00:00" to conveniently find a specific place on the tape automatically.

1 SET COUNTER MEMORY

Press **C. RESET** during playback at a point you wish to locate later. The counter reads "0:00:00". Then press **C.MEMORY**, and "M" appears in front of the counter digits.

2 ACTIVATE COUNTER MEMORY

When you wish to return to the designated point, press **STOP** and then **REW** or **FF**.

- The tape rewinds or fast-forwards and stops at about 0:00:00 automatically.
- To cancel Counter Memory, press **C.MEMORY** again.

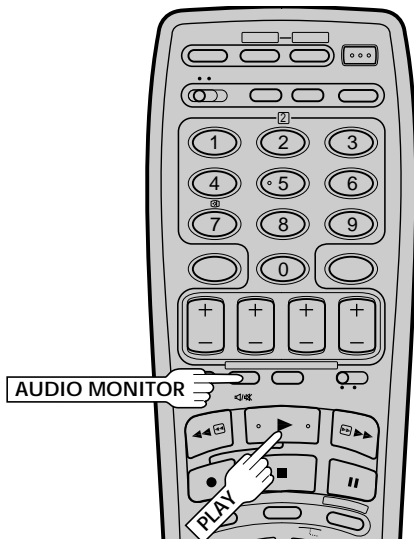
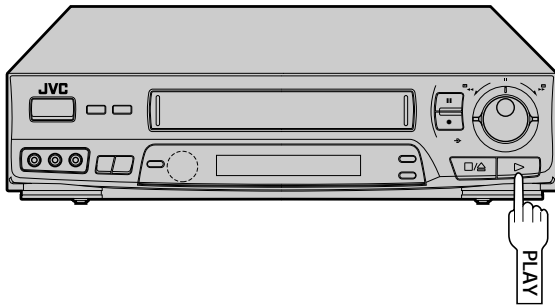

NTSC Playback

Your video recorder is equipped with NTSC circuitry that can play back NTSC tapes.

1 LOAD A CASSETTE

Insert a cassette recorded in NTSC.

2 START PLAYBACK

Press **PLAY**. "NT" appears on the display panel.

- Some TVs shrink the picture vertically and place black bars at the top and bottom of the screen. This is not a malfunction on the part of either the video recorder or the TV.
- The picture may roll up and down. This can be corrected using the V-HOLD control found on some TVs. (This cannot be corrected if the TV does not have a V-HOLD control.)
- The counter and tape remaining time readings will be incorrect.
- During search, still, or frame-by-frame playback, the picture will be distorted, and there may be a loss of colour.
- Depending on the type of TV, the top and bottom portions of superimposed displays may be cut off during NTSC playback.

Soundtrack Selection

Your video recorder is capable of recording three soundtracks (HI-FI L, HI-FI R and NORM) and will play back the one you select.

During Playback

Pressing **AUDIO MONITOR** on the remote control changes the soundtrack being played back as follows:

TRACK		USE
Recorder's Front Panel	On-Screen Display	
L + R	HI FI [Speaker Icon]	For Hi-Fi stereo tapes
L	HI FI [Speaker Icon]	For main audio of Bilingual tapes
R	HI FI [Speaker Icon]	For sub audio of Bilingual tapes
NORM	NORM	For audio-dubbed tapes
L + R + NORM	HI FI NORM	For audio-dubbed tapes

NOTES:

- "L + R" should normally be selected. In this mode, Hi-Fi stereo tapes are played back in stereo, and the NORM track is played back automatically for tapes with only normal audio.
- For instructions on recording NICAM stereo and bilingual programmes, refer to page 24.
- Bilingual programmes are not currently broadcast in the U.K.
- "ON SCREEN" must be set to "ON" or the on-screen displays will not appear (see pg. 23).

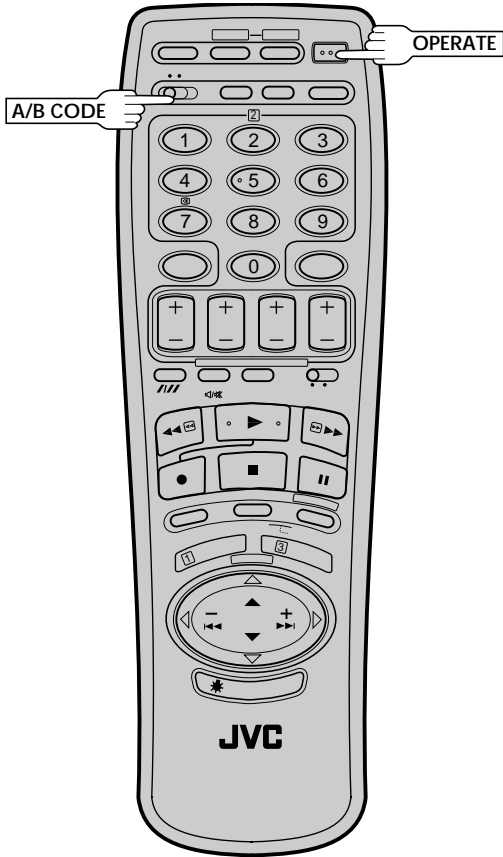
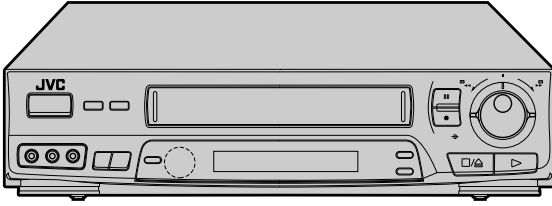

Remote A/B Code Switching

The remote control is capable of controlling two JVC video recorders independently; one set to respond to the remote control's A code control signals and another set to respond to B code control signals. The remote control is preset to send A code signals because your video recorder is initially set to respond to A code signals. You can easily modify your video recorder to respond to B code signals.

1 REMOVE POWER SUPPLY

Unplug the mains power cord from the mains outlet.

2 SET A/B CODE SWITCH

Set to B.

3 RE-SUPPLY POWER

Plug the mains power cord back into the mains outlet.

4 TURN THE RECORDER ON

Press **OPERATE** on the remote control. The recorder will now only respond to B code signals.

NOTE:

Some TV sets may malfunction in response to the B mode. If this happens, switch back to the A mode.

Basic Recording

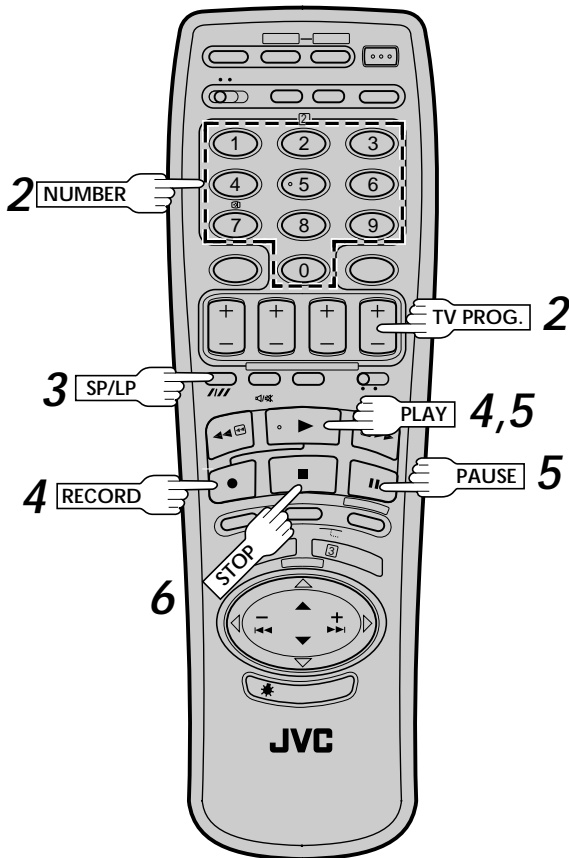
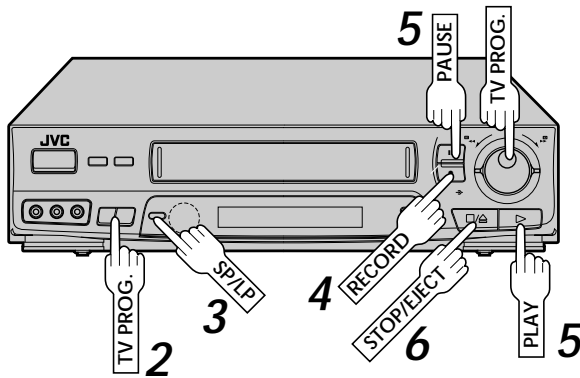

TV signals being received by the recorder's built-in tuner can be recorded onto a video tape. You can "capture" a TV programme using your video recorder.

1 LOAD A CASSETTE

Insert a cassette with the record safety tab intact.

- The counter is reset to 0:00:00 and the recorder power comes on automatically.

2 CHOOSE A PROGRAMME

Press **TV PROG.** +/- or the **NUMBER** keys to select the preset you wish to record. The name of the station appears in the recorder's display panel for 5 seconds, followed by the preset position number. (Only stations that appear in the Confirmation screen will be displayed.)

- The **TV PROG.** dial can also be used to select a preset.

3 SET TAPE SPEED

Press **SP/LP**. Check the SP/LP indicator on the recorder display panel to confirm the selected tape speed.

- Picture quality of LP recordings will not be as high as SP recordings.

4 START RECORDING

Press and hold **RECORD** and **PLAY** on the remote control, or press **RECORD** on the recorder.

B.E.S.T. takes place at the beginning of both the first SP and the first LP recording after inserting the cassette (see pg. 21).

5 PAUSE/RESUME RECORDING

Press **PAUSE**. Press **PLAY** to resume recording.

6 STOP RECORDING

Press **STOP** on the remote control or **STOP/EJECT** on the recorder. Then press **STOP/EJECT** to remove the cassette.

Accidental erasure prevention

- To prevent accidental recording on a recorded cassette, remove its safety tab. To record on it later, cover the hole with adhesive tape.

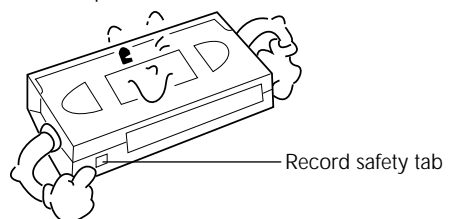

B.E.S.T. Picture System

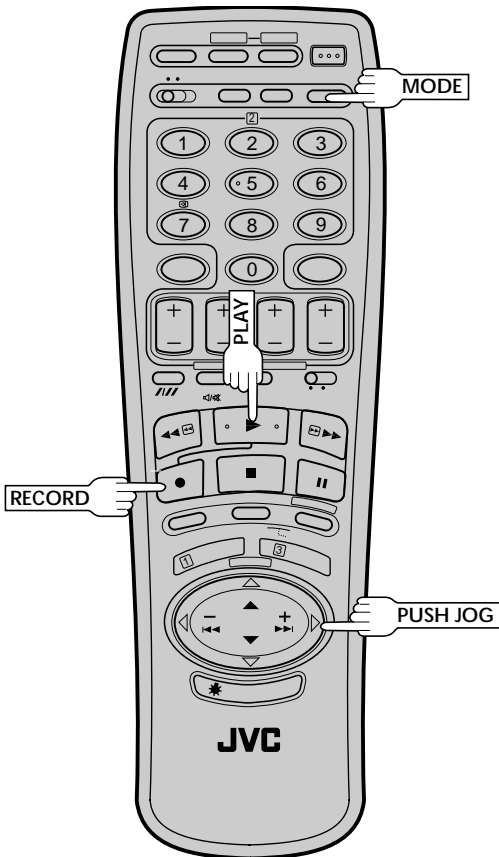
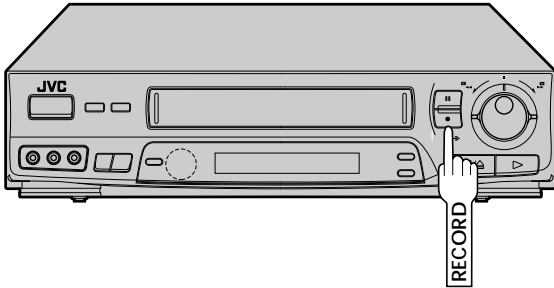

The B.E.S.T. (Biconditional Equalised Signal Tracking) system checks the condition of the tape in use during recording and playback, and compensates to provide the highest-possible recording and playback pictures. The default setting for both recording and playback is "ON".

Recording

1 LOAD A CASSETTE

Insert a cassette with the record safety tab intact.

- The recorder power comes on automatically.

2 ACCESS MODE SELECT SCREEN

Press **MODE**. The On-Screen/B.E.S.T. screen appears.

ON SCREEN	: ON
B.E.S.T.	: ON

[▲▼]: SELECT
[▶]: ON/OFF
[MODE] : EXIT

3 CONFIRM B.E.S.T. STATUS

The default setting is "ON". If this is the case, go to step 4. If not, press **PUSH JOG** to place the pointer next to "B.E.S.T.", then press **PUSH JOG** to set to "ON".

4 CLOSE MODE SELECT SCREEN

Press **MODE**.

5 START RECORDING

Press and hold **RECORD** and **PLAY** on the remote, or **RECORD** on the recorder.

- The recorder spends approximately 7 seconds assessing the condition of the tape, then begins recording.
- When the "BEST" indicator begins blinking, that means adjustment is complete.

Display Panel Indication



As the tape check progresses, the "--" marks on the display panel increase upward. Once the "BEST" indicator starts blinking, the check is complete.

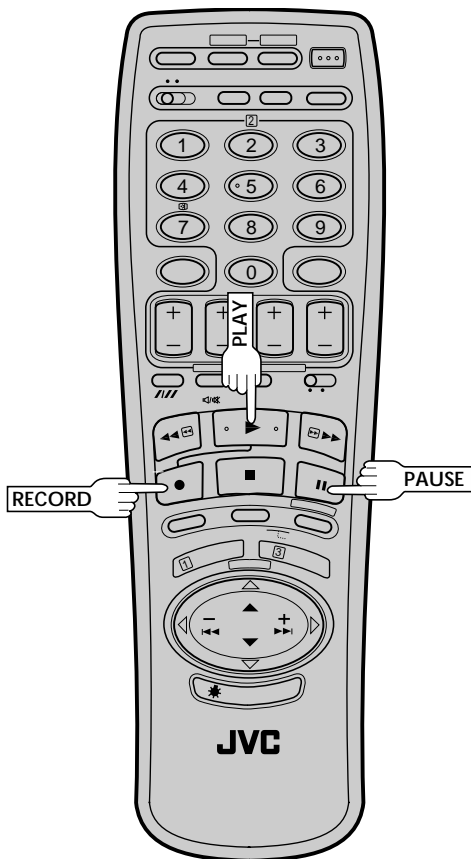
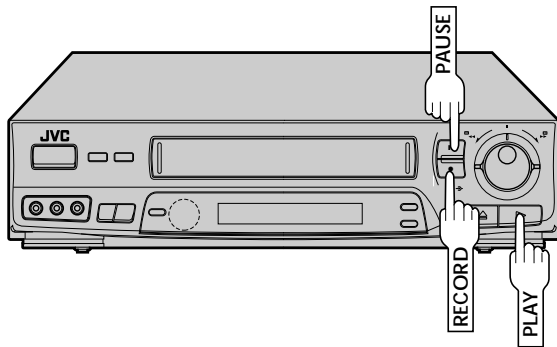

NOTES:

- The B.E.S.T. system works for both SP and LP modes only after a tape has been inserted and the Record mode is first initiated. It does not work during recording.
- In the case of timer recording, the B.E.S.T. system works before recording is initiated.
- Once the cassette is ejected, the B.E.S.T. data is cancelled. The next time the cassette is used for recording, B.E.S.T. is re-performed.

ATTENTION:

Since the B.E.S.T. system works before recording actually starts, there is a delay of approximately 7 seconds after **RECORD** and **PLAY** on the remote are pressed, or **RECORD** on the recorder is pressed. To make sure you record the desired scene or programme in its entirety, first perform the following steps:

- 1) Press and hold **PAUSE** and **RECORD** to engage the RECORD PAUSE mode.
 - The recorder then automatically checks the condition of the tape and, after approximately 7 seconds, re-enters RECORD PAUSE.
- 2) Press **PLAY** to start recording.
 - If you want to bypass the B.E.S.T. system and begin recording immediately, set "B.E.S.T." to "OFF" in step 3 on page 21.

Playback

The recorder assesses the quality of the tape once you initiate playback. When watching a tape recorded with "B.E.S.T." set to "ON", it is recommended that you leave B.E.S.T. on during playback as well.

START PLAYBACK

1

Press **PLAY**.



- The recorder adjusts the playback picture quality based on the quality of the tape in use.
- B.E.S.T. is active during Auto Tracking. "BEST" appears blinking on the recorder's display panel.

NOTES:

- When watching a rental tape, or one recorded on another video recorder, set B.E.S.T. to your preference by performing steps 2 through 4 on page 21.
- "BEST" only appears at the beginning of automatic tracking. Even though it doesn't appear after that, the B.E.S.T. function is operative.

On-Screen Displays

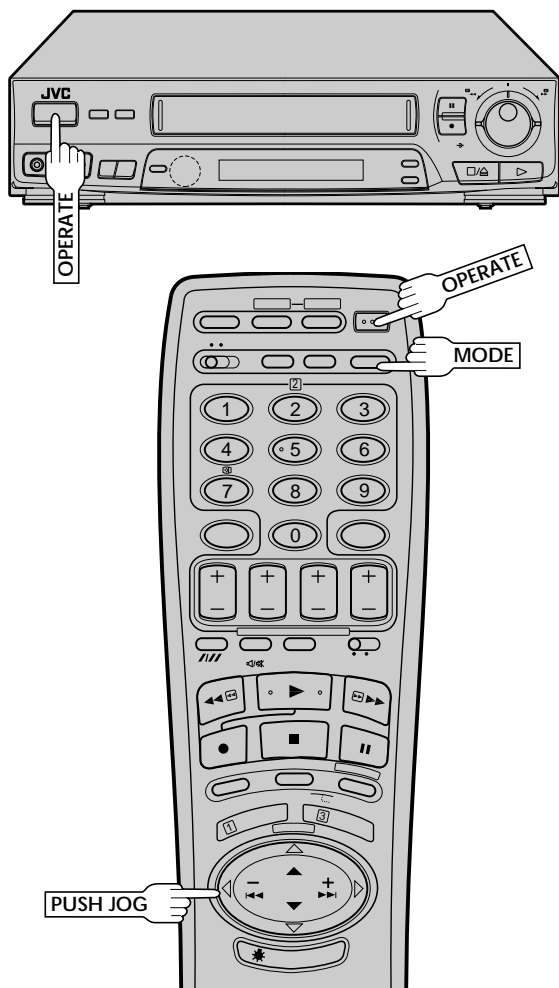

You can choose whether or not to have various operational indicators appear on screen, by setting this function ON or OFF.

1 TURN ON THE RECORDER

Press **OPERATE**.

2 ACCESS MODE SELECT SCREEN

Press **MODE**. The On-Screen/B.E.S.T. screen appears.

ON SCREEN : ON
B.E.S.T. : ON

[▲▼]: SELECT
[▶]: ON/OFF
[MODE]: EXIT

3 SELECT MODE

The pointer should already be next to "ON SCREEN". If not, press **PUSH JOG**▲▼ to place it there.

4 ENABLE/DISABLE ON-SCREEN DISPLAY

The default setting is "ON", so if you want on-screen displays, leave the setting as is and go to step 5. If you don't want the displays to appear, press **PUSH JOG**▶ to set "ON SCREEN" to "OFF".

5 CLOSE MODE SELECT SCREEN

Press **MODE**.

The superimposed indication on the TV screen tells you what the recorder is doing.

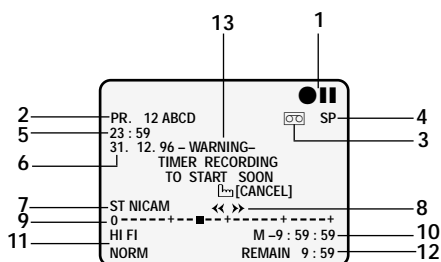

- 1- Operation mode indicators
- 2- Preset position number and station name/Aux. indicator (AUX1, AUX2 or F-AUX)
- 3- Cassette loaded mark
- 4- Tape speed SP/LP/EP (EP is for NTSC playback only)
- 5- Clock display
- 6- Current day/month/year
- 7- NICAM display
- 8- Tape direction
- 9- Tape position indicator (pg. 15)
- 10- Counter display (including Counter Memory indicator)
- 11- Audio mode display
- 12- Tape remaining time indicator
- 13- Timer warning display

Recording Features

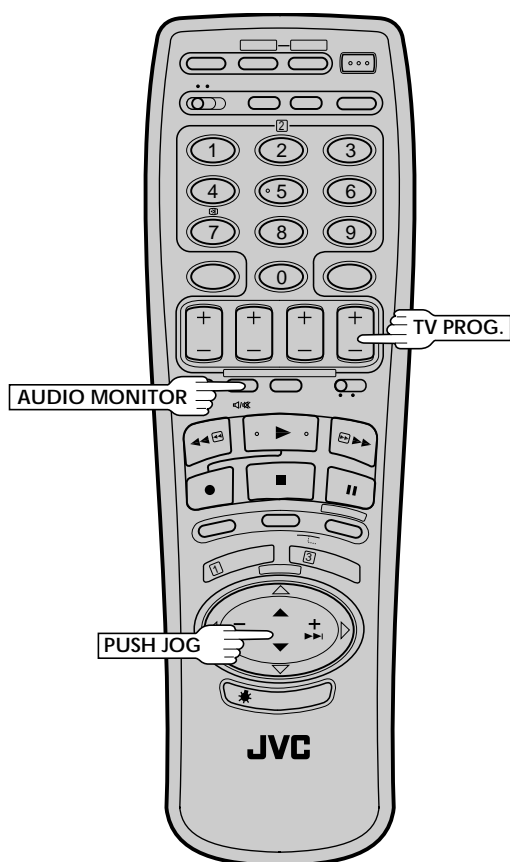
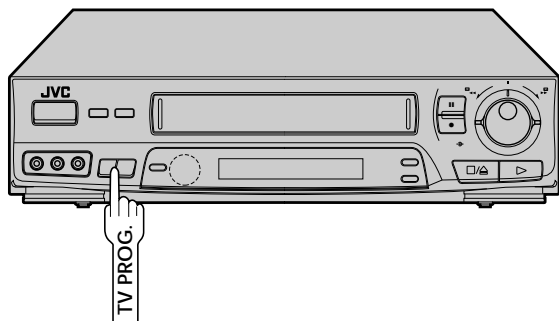

Record One Programme While Watching Another

1 SELECT PRESET TO WATCH

Once recording is in progress, all you need to do is to set the preset controls on the TV for the station you wish to view.

- The programme selected with the TV's preset controls appears on the TV screen while the one selected with the **TV PROG.** or **PUSH JOG** buttons is recorded on the tape.

Receiving NICAM Stereo And Bilingual Programmes

Your recorder is equipped with a digital stereo sound decoder for reception of NICAM stereo and bilingual broadcasts.

- When you switch to a channel that is broadcasting in stereo, "NICAM" and "ST" (stereo) appear on screen for a few seconds.
- When you switch to a channel that is broadcasting a bilingual programme, "NICAM" and "BIL" (Bilingual) appear on screen for a few seconds.
- When you switch to a channel broadcasting a monaural programme, "NICAM" appears on screen for a few seconds.

NOTES:

- "ON SCREEN" must be set to "ON" or the on-screen displays will not appear (☞ pg. 23).
- Bilingual programmes are not currently broadcast in the U.K.

To Record NICAM Stereo And Bilingual Programmes

The NICAM audio programme will be recorded on the Hi-Fi audio track, and the Standard audio programme on the Normal audio track.

- To listen to a stereo programme, press **AUDIO MONITOR** until "L+R" appears on the front panel.
- To listen to a bilingual programme, press **AUDIO MONITOR** until either "HI FI L" or "HI FI R" appears on the front panel (as required).
- To listen to the Standard audio programme, press **AUDIO MONITOR** until "NORM" appears on the front panel.

NOTES:

- If the NICAM stereo signal becomes weak, the broadcast is automatically recorded in monaural for better quality.
- Before playing back a programme recorded in NICAM stereo, or a bilingual programme, refer to "Soundtrack Selection" (☞ pg. 18).

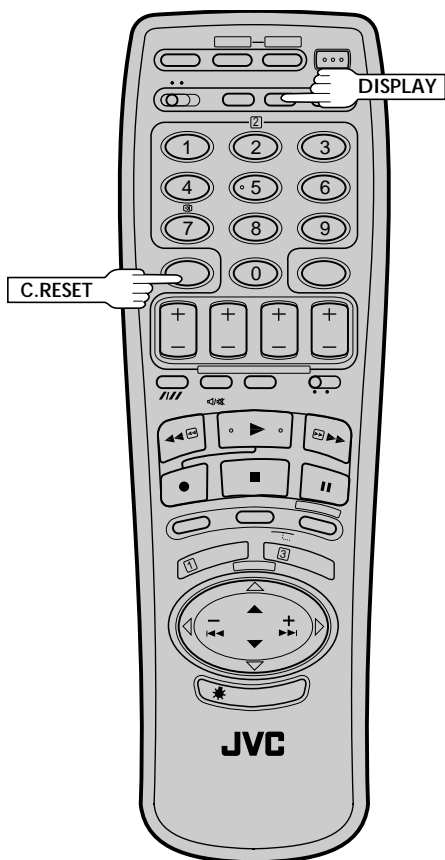
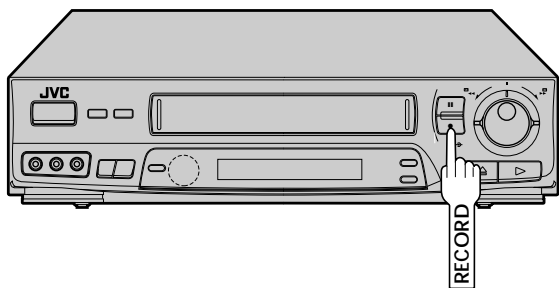

Elapsed Recording Time Indication

You can check the exact time of a recording.

1

SET COUNTER DISPLAY

Press **DISPLAY** until a counter reading appears on the display panel.

2

RESET COUNTER

Press **C. RESET** before starting recording or playback.

- The counter is reset to "0:00:00" and shows the exact elapsed time as the tape runs.

Instant Timer Recording (ITR)

This easy method lets you record for from 30 minutes to 6 hours (selectable in 30-min. increments), and shuts the recorder off after recording is finished.

1

START RECORDING

Press **RECORD** on the recorder.

2

ENGAGE ITR MODE

Press **RECORD** again. ITR blinks and 0:30 appears on the front display panel.

3

SET RECORDING DURATION

If you want to record for more than 30 minutes, press **RECORD** to extend the time. Each press extends recording time by 30 minutes.

NOTE:

You can only perform ITR using the **RECORD** button on the recorder's front panel.

Information On Video Plus+

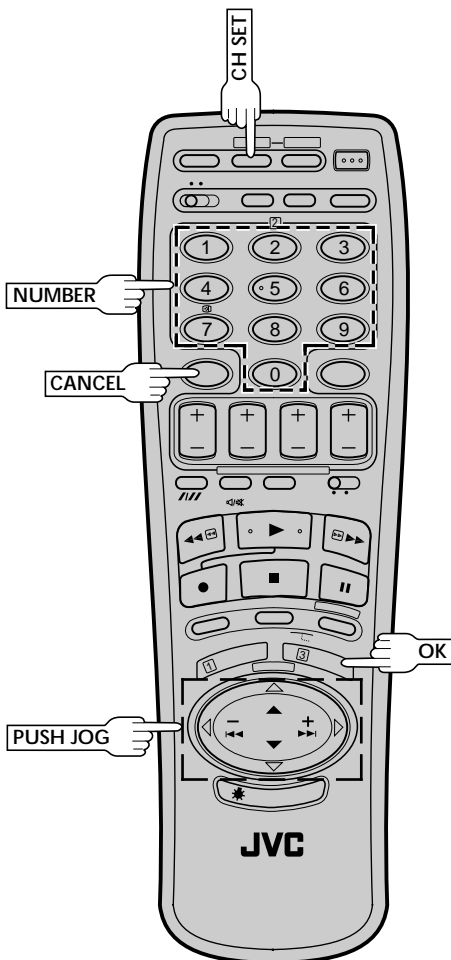
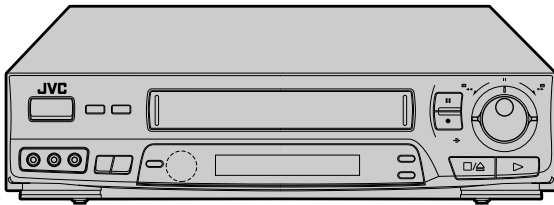

With Video Plus+, timer programming is greatly simplified because each TV programme has a corresponding code number which your recorder is able to recognise.

NOTE:

"Guide Channel" (GUIDE CH) refers to the assigned TV station numbers, according to broadcast area, for Video Plus+ timer recording.

IMPORTANT

Perform the following procedure after the channel setting steps on pages 8 and 41 – 43, and after the Clock Set procedure on page 9.

After setting the Guide Channel, the station names and preset positions may be incorrect if you stored or skipped channels. In this case, re-perform Guide Channel setting.

Guide Channel Set

1 MAKE LIST OF STORED STATION NAMES AND PRESET POSITIONS

(Ex.)	Preset position	Station name
	1	BBC 1
	2	BBC 2
	3	ITV
	4	CH 4

2 ACCESS CH. SET MODE MENU SCREEN

Press and hold **CH SET** for over 2 seconds. The Ch. Set Mode Menu screen appears.

3 SELECT MODE

Press **PUSH JOG** Δ ∇ to place the cursor next to "GUIDE CH SET", then press **OK**. The Guide Ch. Set screen appears.

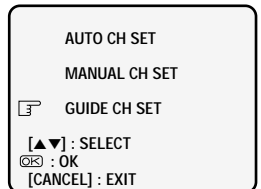

4

ENTER PLUSCODE NUMBER

Press **OK**, and a cursor appears under "GUIDE CH SET". Then, using the **NUMBER** keys, input the **PlusCode** (found in most TV listings) of a program scheduled to be broadcast on each station on the list from step 1, starting at the top. If you enter the wrong number, press **CANCEL** and input the correct number.

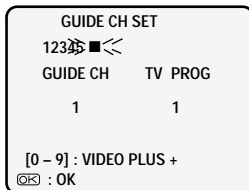

When entering a PlusCode for BBC 1

5

ENTER PRESET POSITION NUMBER

Press **OK** and the display under "TV PROG" begins blinking.

If the blinking number under "TV PROG" agrees with the preset position . . .
... press **OK**.

If the numbers do not agree . . .

... input the preset position using **PUSH JOG** Δ ∇ or the **NUMBER** keys, then press **OK**.

- If you input the PlusCode number of a program that has already aired, "ERROR" appears on screen for a few seconds. Input the correct PlusCode number.
- Repeat steps 4 and 5 as necessary.

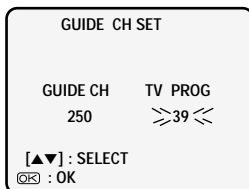

6

CLOSE MENU

Press **CH SET** and selection is complete.

THE SATELLITE RECEIVER IS SHOWN CONNECTED TO THE "AV2 IN" (SCART) CONNECTOR AND THE CABLE SYSTEM CONNECTED VIA THE AERIAL SOCKET AND TUNED TO, FOR EXAMPLE, PRESET POSITION 5 ON YOUR TV.

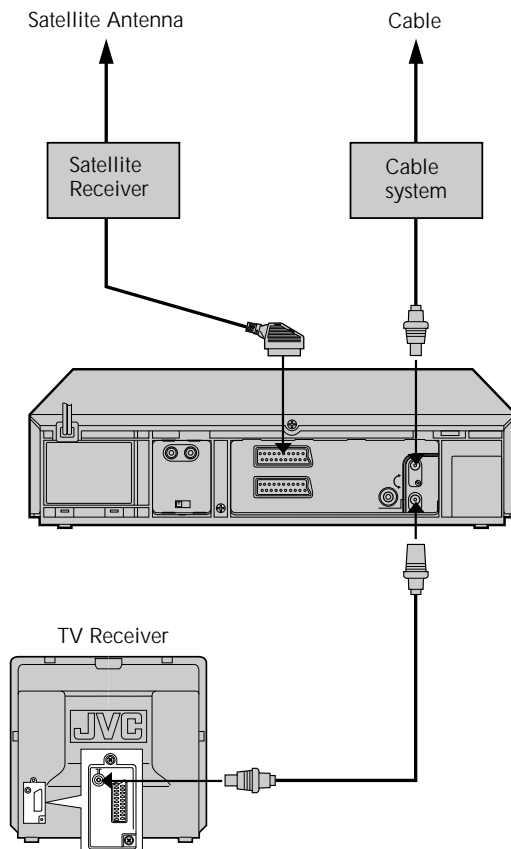

If you already know the Guide Channel number for a station . . .

1- After step 3, press **PUSH JOG** \triangleright .

- "GUIDE CH" begins blinking.

2- Enter the Guide Channel number using the **NUMBER** keys or **PUSH JOG** Δ ∇ , then press **PUSH JOG** \triangleright .

- "TV PROG" begins blinking.

3- Enter the preset position using the **NUMBER** keys or **PUSH JOG** Δ ∇ , then press **PUSH JOG** \triangleleft .

- Repeat 2 and 3 as necessary.

4- Press **CH SET**.

NOTES:

- If you own a satellite receiver, connect it to the AV2 connector on the back of the recorder. Then, in step 5 above, set the input mode to "AUX2" by pressing **NUMBER** key "0" or **TV PROG**. +/- Make sure no cables are connected to the front panel connectors when performing this procedure.
- If you're receiving broadcasts via a cable box through preset "5" (example) on your recorder, set "TV PROG" for "5" in step 5.
- After selecting the programme you wish to record from your cable system or satellite receiver, set the system's timer — if your cable or satellite receiver does not have a timer, leave it switched on.

Video Plus+ Timer Recording

Before performing Video Plus+ Timer Recording, be sure to read "Information on Video Plus+" on page 26.

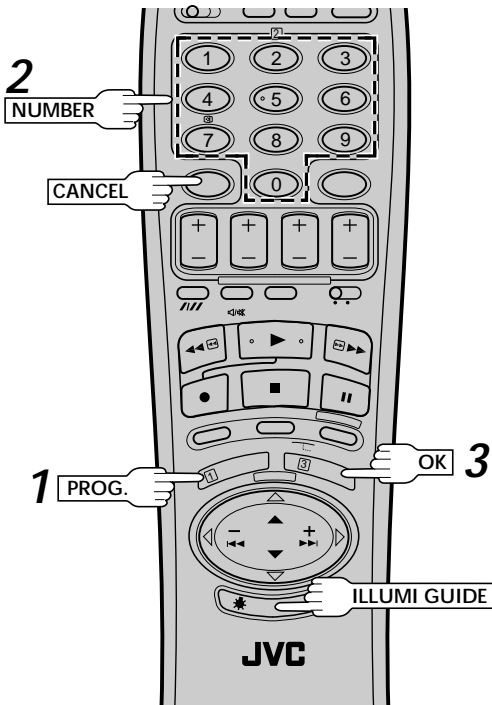
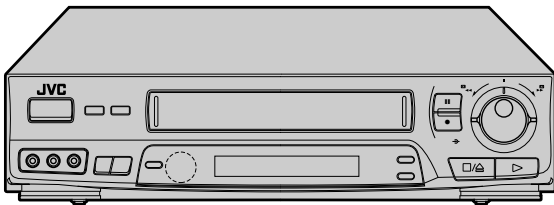

When Using The Illumi-Guide Feature

- Buttons light or blink on the remote control for approximately 10 seconds. If the button or buttons extinguish during timer programming, press **ILLUMI GUIDE** and the button or buttons previously lit or blinking come back on. If the button or buttons do not re-light or start blinking again, press **CANCEL** and re-perform the timer programming procedure from the beginning.
- If for some reason the remote control's signal is not received by the video recorder, press **CANCEL** and re-perform the timer programming procedure from the beginning.

During Video Plus+ and regular timer programming, the Illumi-Guide feature tells you which button on the remote control must be pressed next by lighting it up. To use this feature, press **ILLUMI GUIDE** before performing step 1. (**PROG**, **REW**, **PLAY**, **FF** light up at this time.)

If you aren't going to use the Illumi-Guide feature, go directly to step 1.

1 ACCESS TIMER PROGRAMMING SCREEN

Press **PROG**.

TIMER PROGRAMMING

[0 - 9] : VIDEO PLUS+
[+/-] : EXPRESS PROGRAMMING
[CANCEL] : EXIT

The front display panel looks like this:



- If you are using the Illumi-Guide feature, the following buttons will light up: **NUMBER** keys (0-9), **START +/-**, **STOP +/-**, **DATE +/-**, **TV PROG +/-**, and **CANCEL**.

2 ENTER PLUSCODE NUMBER

Press the **NUMBER** keys to enter the PlusCode number of a programme you wish to record.

V I D E O P L U S +
1 2 3 4 5 6 7 8 9

[0 - 9] : INPUT
[OK] : OK

- If you make a mistake, press **CANCEL** and then input the correct number.

The PlusCode number you enter appears on the front display panel:



- If you are using the Illumi-Guide feature, **OK** blinks when the following buttons are lit: **NUMBER** keys (0-9) and **CANCEL**.

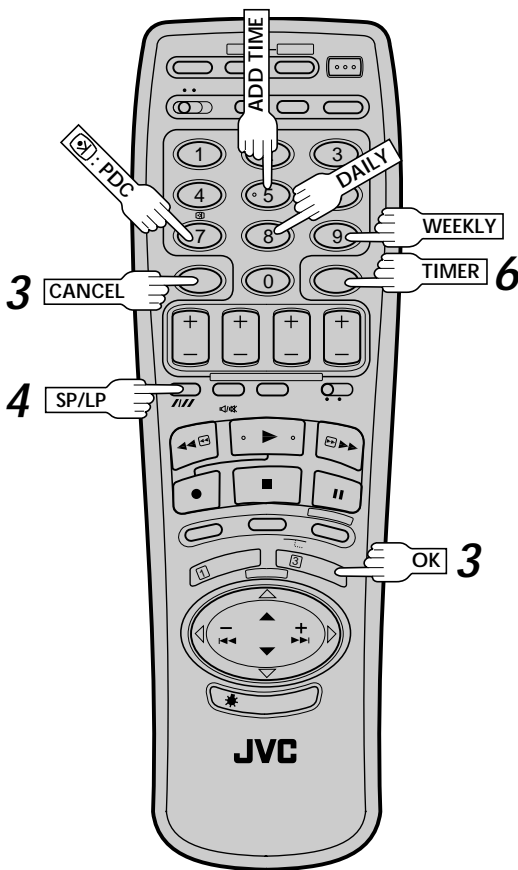
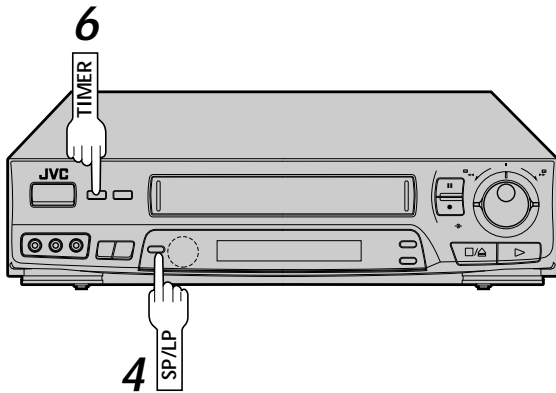

Satellite Receiver Users

To timer-record a satellite broadcast using Video Plus+, perform steps 1 – 6 and, before the selected programme begins, select the appropriate channel on the satellite receiver. Then set the receiver's timer. If your satellite receiver doesn't have a timer, leave the unit's power switched on.

ACCESS VIDEO PLUS+ PROGRAM SCREEN

3

Press **OK**, and the Video Plus+ Program screen appears (if you're just starting out, "Program 1" appears).

PROGRAM 1	
VIDEO PLUS+ 12345678	
START 21:00 →	STOP 22:00
SP	ON
DATE 25.12	TV PROG 1
	BBC1
OK	

- If the number you entered is invalid, "ERROR" appears. Press **CANCEL** and input a valid PlusCode number.

The front display panel looks like this:



- If you are using the Illumi-Guide feature, **OK** blinks.

SET TAPE SPEED

Press **SP/LP** to set the tape speed.

4

IMPORTANT

If you're not receiving PDC (Programme Delivery Control), press **PDC** (NUMBER key "7") to set to "OFF" (pg. 33).

RETURN TO NORMAL SCREEN

Press **OK**.

5

- Repeat steps 1 – 5 for each additional programme.

ENGAGE RECORDER'S TIMER MODE

Press **TIMER**.

6

NOTE:

For safety, your recorder disables all other functions while in the Timer mode. If you want to use the recorder but its Timer mode is engaged, press **TIMER** and all other functions are operable. To re-engage the timer, press **TIMER**.

To Delay The Stop Time . . .

. . . press **ADD TIME** after pressing **OK** in step 3. Each time you press, the Stop time is delayed by 5 minutes (meaning that 5 minutes of recording time is added). You can easily compensate for anticipated programme schedule delays this way.

To Timer-Record Weekly Or Daily Serials . . .

. . . after pressing **OK** in step 3, press **WEEKLY** (NUMBER key "9") for weekly serials or **DAILY** (NUMBER key "8") for daily serials (Monday – Friday).

You can programme this recorder to timer-record as many as 8 programmes. If you try to programme the recorder to record a ninth, "PROGRAM FULL" appears on screen and "FULL" appears on the front display panel. To record the extra programme, you must first cancel any unnecessary programmes (pg. 32).

Regular Timer Programming

Remember, the clock must be set before you can programme the timer (pg. 9).

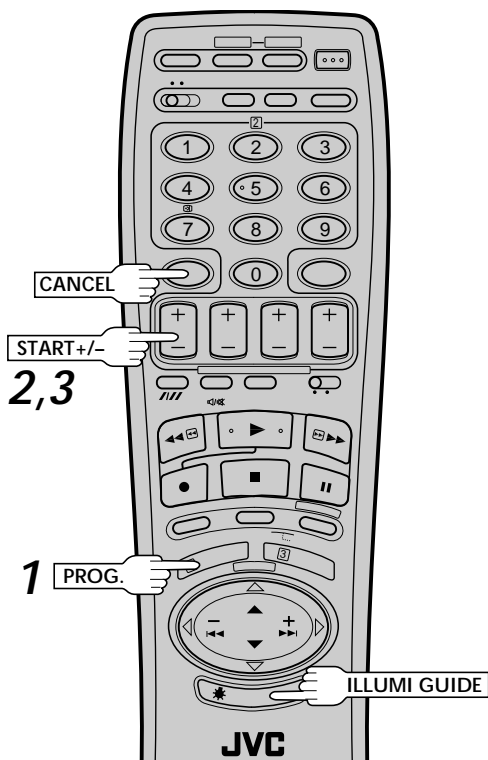
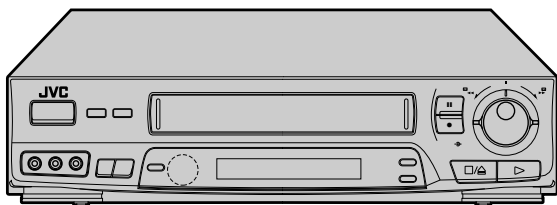

When Using The Illumi-Guide Feature

- Buttons light or blink on the remote control for approximately 10 seconds. If the button or buttons extinguish during timer programming, press **ILLUMI GUIDE** and the button or buttons previously lit or blinking come back on. If the button or buttons do not re-light or start blinking again, press **CANCEL** and re-perform the timer programming procedure from the beginning.
- If for some reason the remote control's signal is not received by the video recorder, press **CANCEL** and re-perform the timer programming procedure from the beginning.

If you don't know the PlusCode number for the programme you wish to record, use the following procedure to set your recorder to timer-record the programme.

Or you can use the Illumi-Guide feature, where the remote control tells you which button to press next by lighting it up. To use the Illumi-Guide feature, press **ILLUMI GUIDE** before performing step 1. (**PROG**, **REW**, **PLAY**, **FF** light up at this time.)

If you aren't going to use the Illumi-Guide feature, go directly to step 1.

1 ACCESS TIMER PROGRAMMING SCREEN

Press **PROG**.

- If you are using the Illumi-Guide feature, the following buttons will light up: **NUMBER** keys (0-9), **START +/-**, **STOP +/-**, **DATE +/-**, **TV PROG +/-**, and **CANCEL**.

2 ACCESS PROGRAMME SCREEN

Press **START +/-**. (If you're just starting out, "Program 1" appears.)

PROGRAM 1	
START	STOP
--:--	--:--
SP	☑ ON
DATE	TV PROG
25.12	--
[+ -]: SET → ☑ OK	

The front display panel looks like this:



- If you are using the Illumi-Guide feature, the following buttons will light up: **START +/-**, **STOP +/-**, **DATE +/-**, and **TV PROG +/-**.

3 ENTER PROGRAMME START TIME

Press **START +/-** to enter the time you want recording to start.

- Press and hold **START +/-** to move in 30-minute increments, or press and release repeatedly to move 1 minute at a time.

PROGRAM 1	
START	STOP
21:00	--:--
SP	☑ ON
DATE	TV PROG
25.12	--
[+ -]: SET → ☑ OK	

The front display panel looks like this:



- If you are using the Illumi-Guide feature, the following buttons remain lit: **START +/-**, **STOP +/-**, **DATE +/-**, and **TV PROG +/-**.

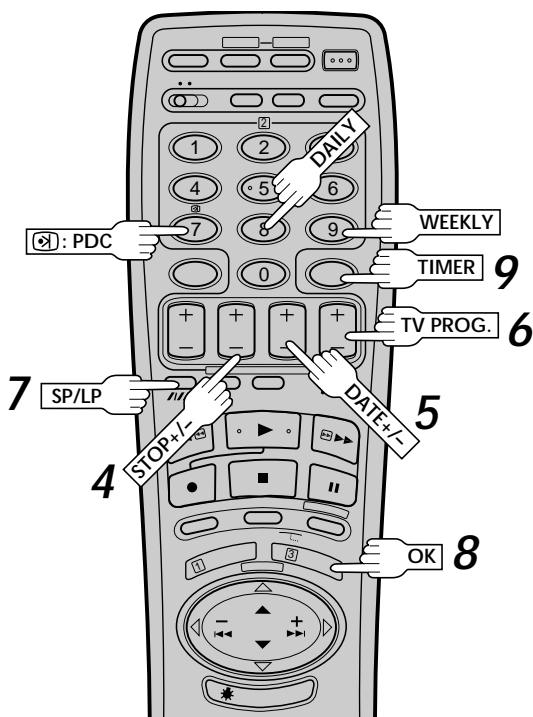
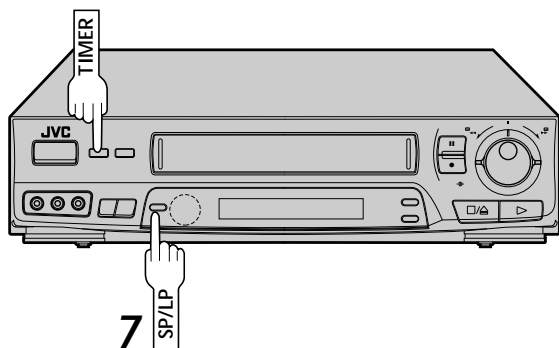

NOTES:

- For safety, your recorder disables all other functions while in the Timer mode. If you want to use the recorder but its Timer mode is engaged, press **TIMER** and all other functions are operable. To re-engage the timer, press **TIMER**.
- You can programme this recorder to timer-record as many as 8 programmes. If you try to programme the recorder to record a ninth, "PROGRAM FULL" appears on screen and "FULL" appears on the front display panel. To record the extra programme, you must first cancel any unnecessary programmes (see pg. 32).
- To timer-record a satellite broadcast through a satellite receiver connected to the AV2 IN connector on the back of the recorder, in step 6 above, set "TV PROG" to "AUX2" by pressing **TV PROG.** +/- . Before the selected programme begins, select the appropriate channel on the satellite receiver, then set the receiver's timer. If your satellite receiver doesn't have a timer, leave the unit's power switched on.

4

ENTER PROGRAMME STOP TIME

Press **STOP +/-** to enter the time you want recording to stop.

- If you are using the Illumi-Guide feature, the following buttons remain lit: **START +/-**, **STOP +/-**, **DATE +/-**, and **TV PROG +/-**.

5

ENTER PROGRAMME DATE

Press **DATE +/-**. (The current date appears on screen. The date you enter appears in its place.)

- If you are using the Illumi-Guide feature, the following buttons remain lit: **START +/-**, **STOP +/-**, **DATE +/-**, and **TV PROG +/-**.

6

ENTER PRESET POSITION

Press **TV PROG.** +/-.

PROGRAM 1	
START 21 : 00	STOP 22 : 00
SP	<input checked="" type="checkbox"/> ON
DATE 25. 12	TV PROG 1
	BBC1
[+/-] : SET →	<input checked="" type="checkbox"/> OK



- If you are using the Illumi-Guide feature, **OK** blinks when the following buttons are lit: **START +/-**, **STOP +/-**, **DATE +/-**, and **TV PROG +/-**.

7

SET TAPE SPEED

Press **SP/LP** to set the tape speed.

IMPORTANT

If you're not receiving PDC (Programme Delivery Control), press : **PDC** (NUMBER key "7") to set to "OFF" (see pg. 33).

8

RETURN TO NORMAL SCREEN

After confirming all information is correct, press **OK** and the normal screen appears.

- Repeat steps 1 – 8 for each additional programme.

9

ENGAGE RECORDER'S TIMER MODE

Press **TIMER**.

To Timer-Record Weekly Or Daily Serials . . .
 . . . anytime during steps 2 through 8, press **WEEKLY** (NUMBER key "9") for weekly serials or **DAILY** (NUMBER key "8") for daily serials (Monday – Friday).

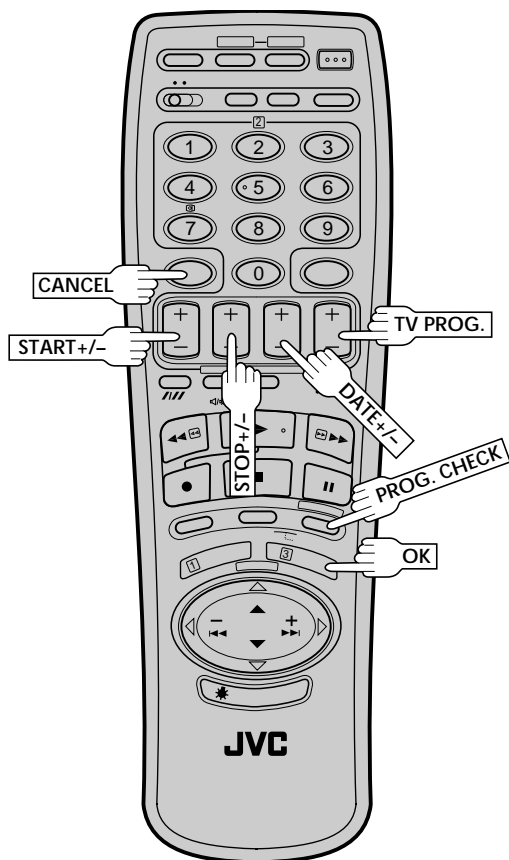
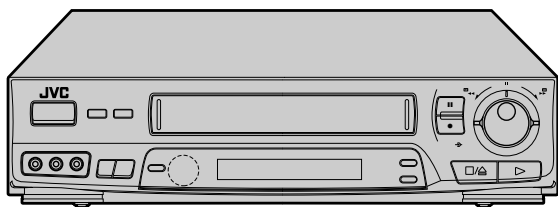

Check And Cancel Programmes

1 ACCESS PROGRAMME SCREEN

Press **PROG CHECK**. Each time you press the next program's information appears.

- Press **OK** and watch the front display panel as the Start and Stop times, the Date and the Preset appear.
- If the recorder is turned on and the TV is set to its VIDEO mode, you can check program information on screen as well.

If All Information Is Correct . . .

. . . programming is completed.

If You Wish To Revise Data . . .

. . . with the recorder's power turned on, go to step 2.

If You Wish To Cancel A Program . . .

. . . with the recorder's power turned on, press **CANCEL**. All information you input is deleted.

2 REVISE PROGRAMME INFORMATION

Input the appropriate data using the **START +/-**, **STOP +/-**, **DATE +/-** and **TV PROG.** +/- buttons on the remote control.

Timer Warning

If you have programmed your recorder to timer-record a programme or a series of programmes, a warning appears on screen to tell you that the recording is to start in 5 minutes.

- WARNING -
TIMER RECORDING
TO START SOON
[CANCEL]

NOTES:

- The warning only appears if you're not in the Timer mode at that time.
- If this recorder is being used as the player for tape dubbing, the warning screen is recorded on the tape in the other video recorder.

The warning blinks for the entire 5 minutes leading up to the start of timer recording. To clear the display, press **CANCEL**.

Auto SP/LP Timer

If, when recording in SP mode, there is not enough tape to record the entire programme, the recorder automatically switches to LP mode to allow complete recording.

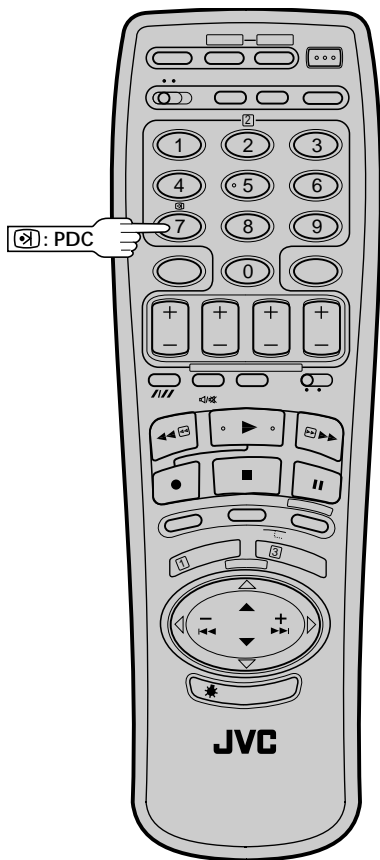
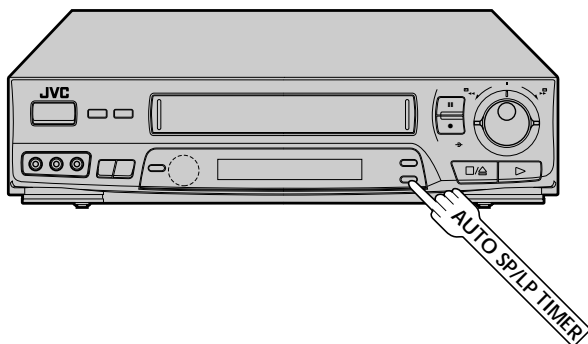

1

ENGAGE AUTO SP/LP TIMER

Press **AUTO SP/LP TIMER** on the recorder front panel. The button lights "green".

For Example . . .

Recording a program of 210 minutes in length onto a 180-minute tape

Approximately 150 minutes Approximately 60 minutes

SP mode	LP mode
Total 210 minutes	

Make sure you press **AUTO SP/LP TIMER** before performing timer programming.

NOTES:

- The Auto SP/LP Timer feature is not available during ITR (Instant Timer Recording), and the feature will not work properly with any tapes longer than E-180 as well as some tapes of shorter lengths.
- Even if, in step 1, you press **AUTO SP/LP TIMER** and it lights "green", that doesn't mean that the recorder will automatically change from SP to LP mode during the course of the recording. Watch the tape later to confirm.
- If you have programmed the recorder to timer-record 2 or more programs, the second programme and those thereafter may not fit on the tape if you engage the Auto SP/LP Timer mode. In this case, make sure the mode is not engaged, then set the tape speed manually during timer programming.
- There may be some noise at the point on the tape where the recorder switches from SP to LP mode.
- If you perform timer recording with both PDC and the Auto SP/LP Timer activated, and the programme goes beyond its originally scheduled length, there may be times when the programme cannot be recorded in its entirety.

PDC Recording

Now available from some TV stations, PDC (Programme Delivery Control) is a service designed to assure safe, accurate timer recording. With this system, special code signals are transmitted together with the audio/video signals. These code signals control your video recorder and have precedence over advertised times you preset in the timer. This means that your recorder will start and stop recording when the preset TV programmes actually start and end — even if the broadcast time of a preset TV programme is changed.

To Use PDC Service . . .

The default setting for PDC is "ON". To cancel PDC, press  : **PDC (NUMBER key "7")** so that "OFF" is displayed during Video Plus+ or regular timer programming.

NOTES:

- When you manually enter programmes (regular timer programming), set the start time (PDC time) exactly as advertised in the TV listing. A different time than advertised will result in no recording.
- PDC Recording is also possible when a satellite tuner or a cable box is connected to AV2 IN on your recorder.
- When PDC recording is performed, the Instant ReView programme readout number may not match the actual number of programmes that have been timer-recorded (see pg. 14).

Edit To Or From Another Video Recorder

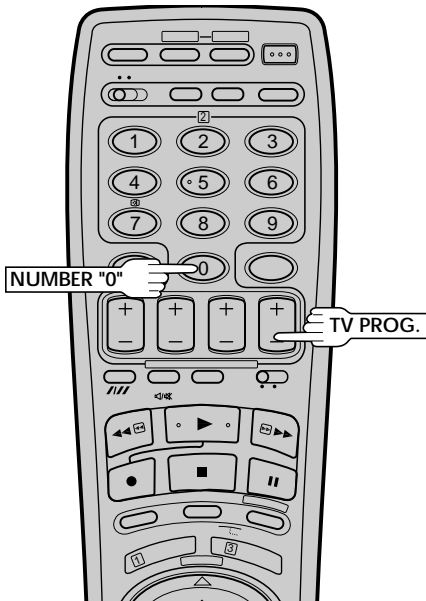

You can use your video recorder as the source player or the recording deck.

1 MAKE CONNECTIONS

Connect the player's AUDIO/VIDEO OUT connector to the recorder's AUDIO/VIDEO IN connector.

When Using Your Video Recorder As The Source Player . . .
 . . . connect its AV1 IN/OUT connector to the recording deck.

When Using Your Video Recorder As The Recording Deck . . .
 . . . you can use the AV1 IN/OUT or AV2 IN connectors.

2 SET RECORDING DECK'S INPUT MODE

Set to AUX. With this video recorder, press **NUMBER** key "0" and/or **TV PROG.** to select depending on the connector being used — "AU 1" for the AV1 IN/OUT connector, or "AU 2" for the AV2 IN connector.

3 START SOURCE PLAYER

Engage its Play mode.

4 START RECORDING DECK

Engage its Record mode.

NOTE:

All necessary cables can be obtained from your dealer.

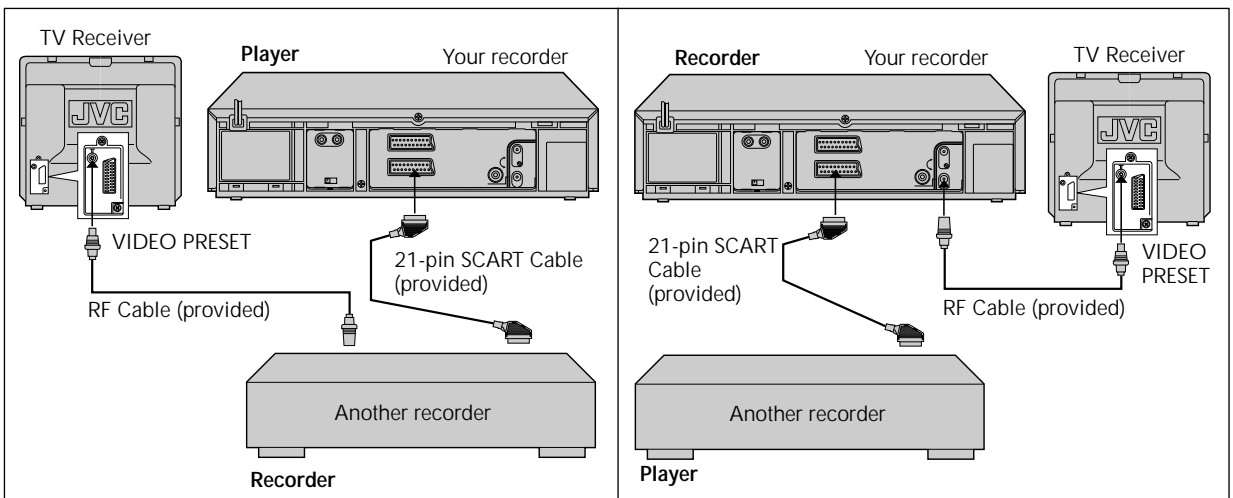

Edit From A Camcorder

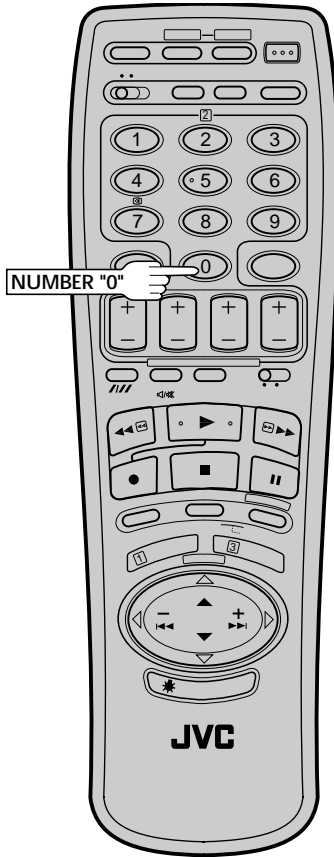

You can use a camcorder as the source player and your video recorder as the recorder.

1 MAKE CONNECTIONS

Connect the camcorder's AUDIO/VIDEO OUT connectors to the recorder's front panel AUDIO/VIDEO input connectors.

- When a Master Edit Control-equipped JVC camcorder is used, the camcorder is capable of controlling the recorder. Refer to the camcorder's instruction manual for operating procedure.

2 SET RECORDER'S INPUT MODE

Press **NUMBER** key "0". "F-AU" appears in place of a preset number.

3 START CAMCORDER

Engage its Play mode.

4 START RECORDER

Engage its Record mode.

NOTE:

Connections made to the front panel AUDIO/VIDEO input connectors automatically override those made to the rear panel AUDIO/VIDEO input connectors.

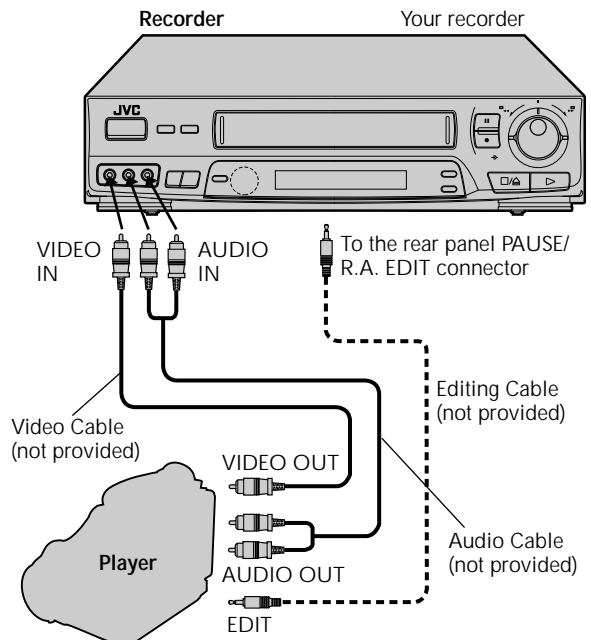

Random Assemble Editing

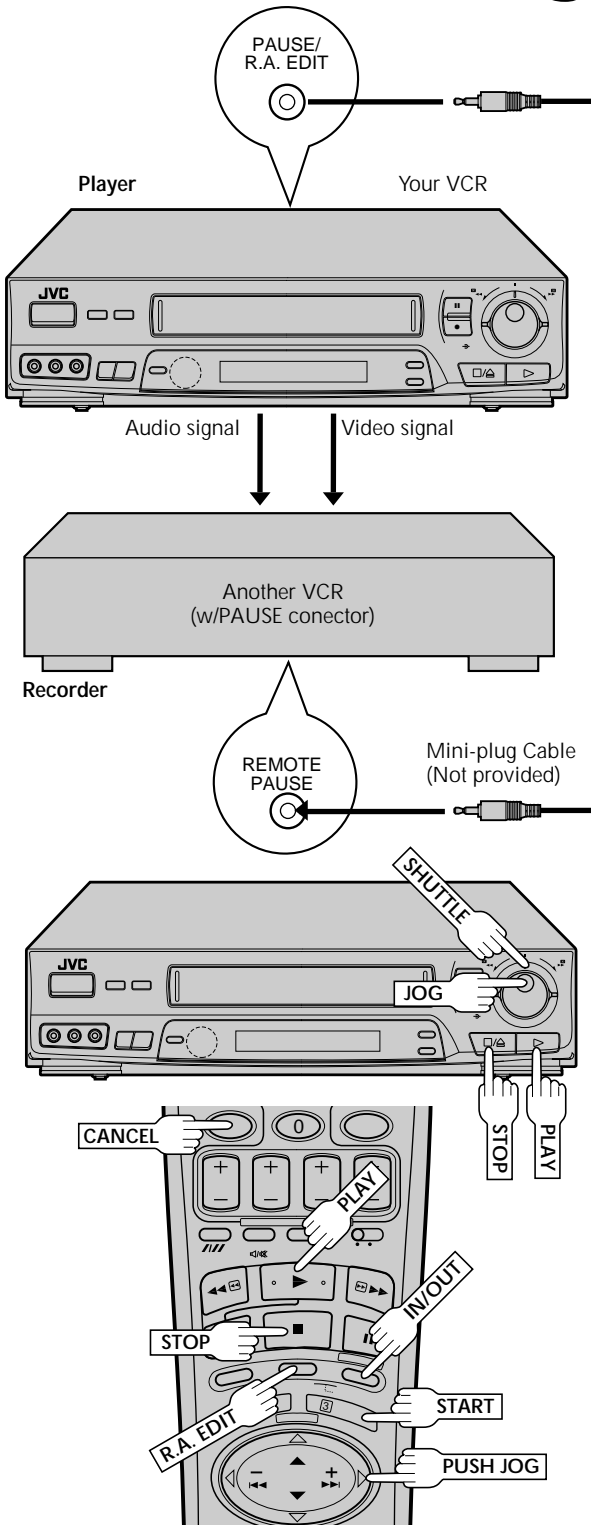

This function makes it easier to create edited videos when your video recorder is used as the source player in combination with another video recorder equipped with a Remote PAUSE Connector. You can pre-program up to 8 scenes or "cuts" for automatic editing in the sequence you have specified.

1 MAKE CONNECTIONS

Connect your recorder's VIDEO OUT and AUDIO OUT connectors to the VIDEO IN and AUDIO IN connectors on the recording deck, and connect your recorder's PAUSE/R.A. EDIT connector to the PAUSE connector on the recording deck.

- If the recording deck doesn't have a PAUSE connector, connect to the R.A. EDIT connector instead.
- The Mini-plug cable is a mono 3.5 mm mini-plug to mono 3.5 mm mini-plug connector.

2 PREPARE FOR EDITING

Insert the cassette to be recorded on into the recorder and set the recorder's input mode.

3 LOAD SOURCE CASSETTE

Insert the source cassette into your recorder.

4 START SOURCE PLAYBACK

Press **PLAY**.

5 ACCESS R.A. EDIT FUNCTION

Press **R.A. EDIT**.

- The screen is superimposed on the video playback in step 6.

6 LOCATE EDIT-IN POINT

Find the point on the source tape from where you want the edited scene to begin by pressing **PUSH JOG** <|> or using the **SHUTTLE** ring or the **JOG** dial, then press **IN/OUT** on the remote control.

R.A. EDIT	EDIT MODE
1 0:00:00	
2	
3	
4	
5	
6	
7	
8	
TTL 0:00:00	CNT 0:00:00

- The edit-in point is registered in memory and appears on the screen.
- You can also perform an Index Search (if index marks have been previously recorded on the tape at the desired points) to find the points you want, but this will result in reduced accuracy.

Refer to the illustrations on page 36.

7

LOCATE EDIT-OUT POINT

Find the point where you want the edited scene to end by pressing **PUSH JOG** <1> or using the **SHUTTLE** ring or the **JOG** dial, then press **IN/OUT** on the remote control.

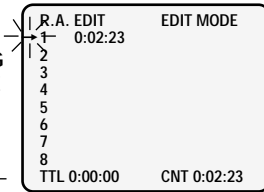

- The edit-out point is registered in memory and appears on the screen.
- The total time of the edited scenes is displayed to the right of "TTL".
- Repeat steps 6 and 7 for each additional scene.

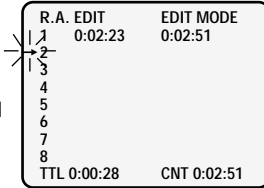

NOTES:

- You can also monitor the sound when searching for scenes you want to edit in steps 6 – 7. Since you can hear the soundtrack during selection, you can avoid abrupt or unnatural sounding scene-to-scene transitions.
- When editing, there may be a discrepancy of about 2 seconds on the source tape between the locations you chose as edit-in/-out points and the locations your recorder recognizes as those points.
- For any scene, the edit-out point must have a counter reading that is at least 1 second after the corresponding edit-in point. Any less than 1 second and the edit-out point will not be registered.
- Since the source recorder prerolls during Random Assemble Editing, there must be at least 15 seconds worth of recorded material prior to any edit-in point on the source tape.
- If the search time for an edit-in point exceeds 5 minutes, the recording deck enters its Stop mode and editing will not take place.
- During steps 6 and 7 — if you engage the Pause mode while registering edit-in and -out points in the R.A. Edit screen, the characters in the on-screen display may become distorted. This is normal.

To Make Corrections . . .

. . . during step 6 or 7, you can cancel registered in and out points by pressing **CANCEL** on the remote control. Each time you press, the preceding point is erased.

- If, for example, you have registered 5 sets of in and out points and want to reset the first set, you have to press **CANCEL** until all points after the first set have been erased. Reenter them after you've repaired the first set of points.

Memory Capacity

Random Assemble Editing shares memory space with the recorder's timer. If there are programs occupied by timer-recording data, those spaces cannot be used to register edit-in and -out points — meaning you won't be able to edit 8 scenes.

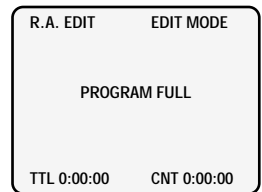

- When all 8 programs are full, "PROGRAM FULL" appears on the R.A. EDIT screen.
- To cancel a program, see page 32

RM-V704U Multi-Brand R.A. Edit Controller (Not provided)

By connecting this controller to your recorder's R.A. EDIT connector, you can perform Random Assemble Editing in combination with a second non-JVC video recorder. The controller is compatible with various major recorder brands. For compatible systems and availability, please consult your JVC dealer.

BRAND LIST			
AKAI	JVC	SANYO	THOMSON
BLAUPUNKT	mitsubishi	SELECO	TELEFUNKEN
FERGUSON	NEC	REX	SABA
GRUNDIG	PANASONIC	SHARP	NORDMENDE
HITACHI	PHILIPS	SONY	TOSHIBA

NOTE:

- Although the RM-V704U is designed to operate the recording deck, it may not work with some recorders, or may have limited function capability.

8

PREPARE RECORDING DECK

Engage its Record-Standby mode.

9

START R.A. EDIT

Press **START**.

- Automatic editing begins; all the specified scenes are copied to the recording deck in the order they were registered.
- The on-screen display remains while your recorder searches for each scene (blinking cursor indicates scene currently being searched for), but disappears during actual editing.
- During scene search, the recording deck automatically enters its Record-Standby mode. "SEARCHING" appears on the screen.
- When all registered scenes have been edited, your recorder enters the Pause mode, the recording deck enters its Record-Standby mode, and the cursor blinks at the next available number.

10

END R.A. EDIT

Press **R.A. EDIT** again, and engage the Stop mode for your recorder and for the recording deck.

Audio Dubbing

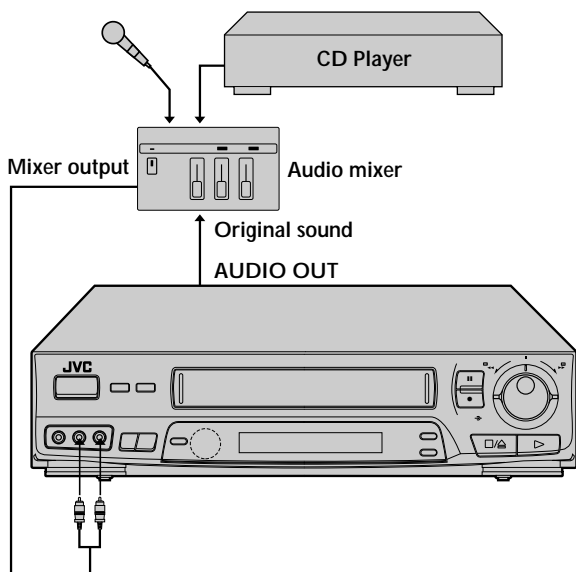
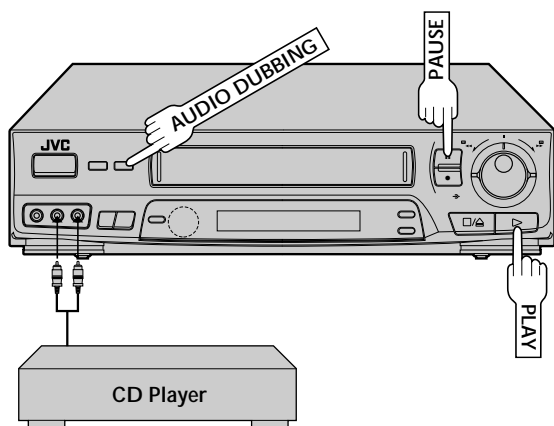

Audio dubbing replaces the normal audio sound of a previously recorded tape with a new soundtrack.

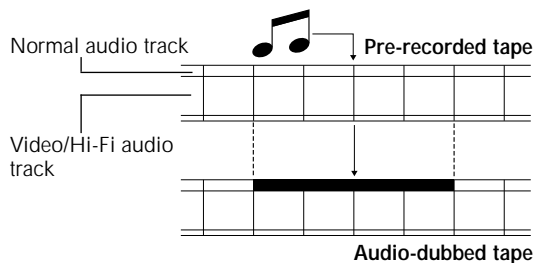

1

MAKE CONNECTIONS

Connect an audio component to the AUDIO IN L + R connectors on the recorder's front panel. *When connecting monaural equipment, use only the recorder's AUDIO IN L connector.

2

SET INPUT MODE

Press **NUMBER** key "0". "F-AU" appears in place of a preset number.

3

LOCATE START POINT

Press **PLAY** to start playback of the tape in your recorder, and press **PAUSE** when you find the point where you want to start dubbing.

4

ENGAGE AUDIO DUBBING

Press **AUDIO DUBBING**.

- To perform audio dubbing with audio mixing, press **AUDIO MONITOR** to select "L + R" at this point. *Audio dubbing with audio mixing is not possible if you're using a monaural audio component, or if you don't have an audio mixer.

5

START DUBBING

Engage the audio component's Play mode, then press **PLAY** to start the tape in your recorder. Audio dubbing begins at this point.

- To stop dubbing temporarily, press **PAUSE**. Press **PLAY** to resume dubbing.

6

END AUDIO DUBBING

Press **STOP** to stop the tape in your recorder, and engage the audio component's Stop mode.

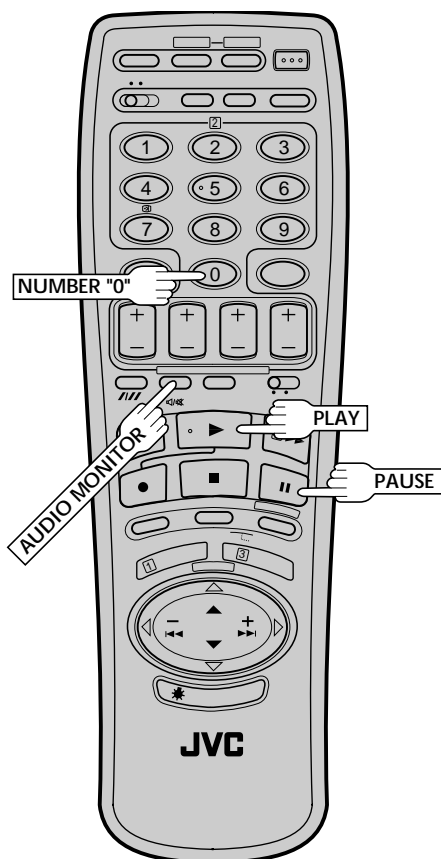

NOTES:

- When monitoring the sound during Audio Dubbing, the normal soundtrack is automatically selected. If you wish to hear the mixed sound (Hi-Fi + Normal soundtracks), press **AUDIO MONITOR** to select "L+R+NORM" (☞ pg. 18).
- Audio dubbing stops automatically when the counter reaches "0:00:00", and the recorder enters the Play mode. Check the counter reading before dubbing.
- Audio dubbing is also possible using the rear panel AV1 IN/OUT or AV2 IN connectors. When using these connectors, make sure to select the correct input mode in step 2.
- Connections made to the recorder's front panel are given priority over those made to the rear panel connectors.
- Audio dubbing cannot be performed on a cassette that has had its record safety tab removed.
- When playing back an audio-dubbed tape, press **AUDIO MONITOR** to select the soundtrack you wish to hear (☞ pg. 18).

Multi-Brand Remote Control

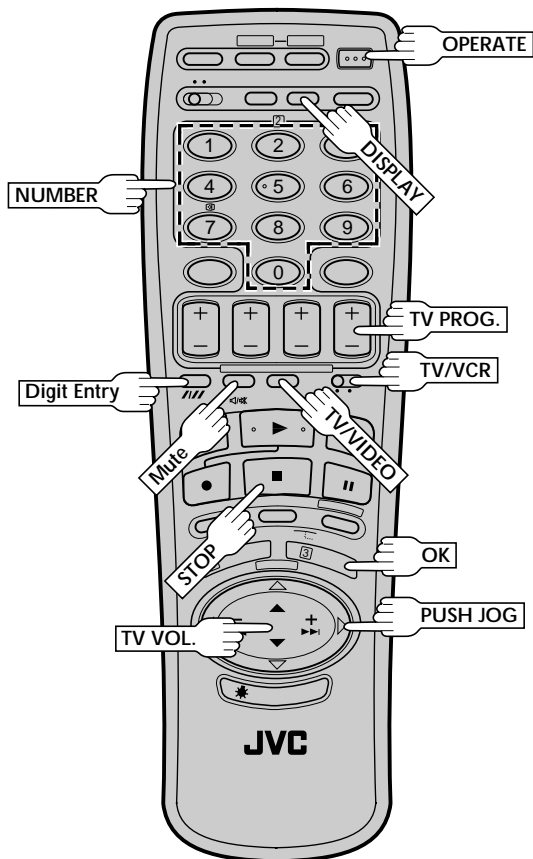

Your remote control can operate the basic functions of your TV set. In addition to JVC TVs, other manufacturer's TVs can also be controlled by setting the appropriate switch on the remote control.

Before you start . . .

- Turn on the TV using its remote control.
- Set the remote control's **TV/VCR** switch to TV.

NOTE:

If your TV is a JVC, you don't have to set the code in step 1. Go to step 2.

1 SET TV BRAND CODE

Refer to the chart below. While holding down **OPERATE**, enter your TV's brand code using the **NUMBER** keys, then press **STOP**.

- You don't have to repeat this step until you replace your remote control's batteries.

2 TRY OPERATING TV

Press **OPERATE** on the remote to turn the TV off. If it goes off, try other operations.

- The **OPERATE** button, **TV/VIDEO** button, **TV PROG.** +/- button, **TV VOL** Δ∇ button and **Mute** button on the remote can all be used to operate the TV.
- To return the remote to video recorder control, set its **TV/VCR** switch to VCR.

IMPORTANT

Although the provided remote control unit is compatible with JVC televisions, as well as many other models, it may not work with your TV, or in some instances, may have limited function capability.

Control Your TV Using Additional Buttons

The **NUMBER** keys on the remote can also be used to select the TV's preset by setting the remote control to the TV mode.

- 1 Set the **TV/VCR** switch to TV.
 - 2 Use the **NUMBER** keys, and the **Digit Entry** (SP/LP) button, the **PUSH JOG** button, the **DISPLAY** button or the **OK** button to select the TV's preset.
- With televisions under Code 01, 03, 04, 06, 07, 10 or 11, the **Digit Entry** button corresponds to the 1-digit/2-digit entry switching button (often labelled - / -) of your TV's remote control.
 - With televisions under Code 01, 08 or 09, the **PUSH JOG** < button corresponds to the 10 + button, and the **PUSH JOG** > button corresponds to the 20 + button of your TV's remote control.
 - With televisions using Code 09, the **DISPLAY** button corresponds to the 30 + button.
 - With televisions using Code 06, the **OK** button corresponds to the ENTER button of your TV's remote control.

NOTES:

The way these buttons are used is determined by your TV. Use these buttons as instructed for your TV's remote control.

CODE	TV BRAND NAME
01	JVC
02	BRANDT, NORDMENDE, SABA, TELEAVIA, TELEFUNKEN, THOMSON
03	FERGUSON
04	PHILIPS
05	BLAUPUNKT, GRUNDIG
06	SONY
07	PANASONIC
08	GRAETZ, ITT, LUXOR, SALORA, SELECO
09	MIVAR
10	HITACHI
11	TOSHIBA
12	MITSUBISHI
13	FINLUX
14	NOKIA

Storing Channels Manually

Store channels that were not stored during Auto Channel Set.

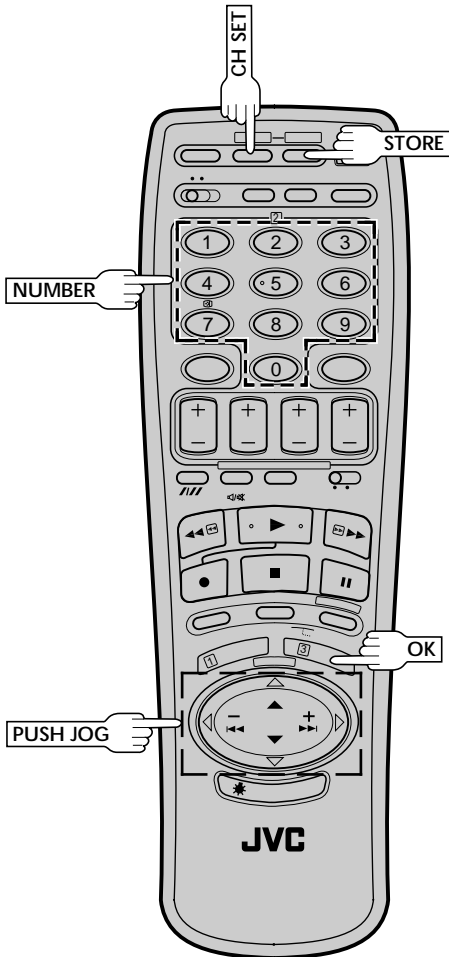
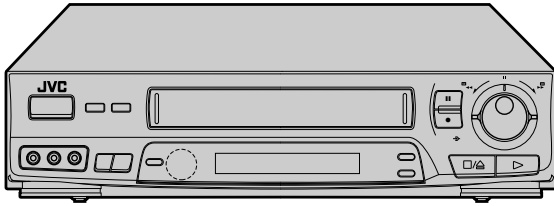

1

ACCESS CH. SET MODE MENU

Press and hold **CH SET** for more than 2 seconds. The Ch. Set Mode menu appears.

2

SELECT MODE

Press **PUSH JOG** $\Delta \nabla$ to select "MANUAL CH SET", then press **OK**. The Confirmation screen appears.

3

SELECT POSITION

Press **PUSH JOG** $\Delta \nabla \triangleleft \triangleright$ until an open position in which you want to store a channel begins blinking, then press **OK**. The Manual Ch. Set screen appears.

4

INPUT CHANNEL

The number "21" appears blinking to the right of "CH". Press the **NUMBER** keys to input the preset number of the channel you want to store.

- Although "CH" is set to "21" when the Manual Ch. Set screen appears, to store channel 21, you must select "21" using the **NUMBER** keys.
- For fine tuning adjustment, press **PUSH JOG** \triangleright until the item under "CH" begins blinking, then press **PUSH JOG** $\Delta \nabla$. While tuning, "F+" or "F-" appears.

5

ENTER NEW CHANNEL INFORMATION

Press **OK** or **STORE**, and the Confirmation screen appears.

- Repeat steps 3 through 5 as necessary.

6

CLOSE CONFIRMATION SCREEN

Press **CH SET**.

- To input the station name, see page 43.
- To change positions, see page 42.

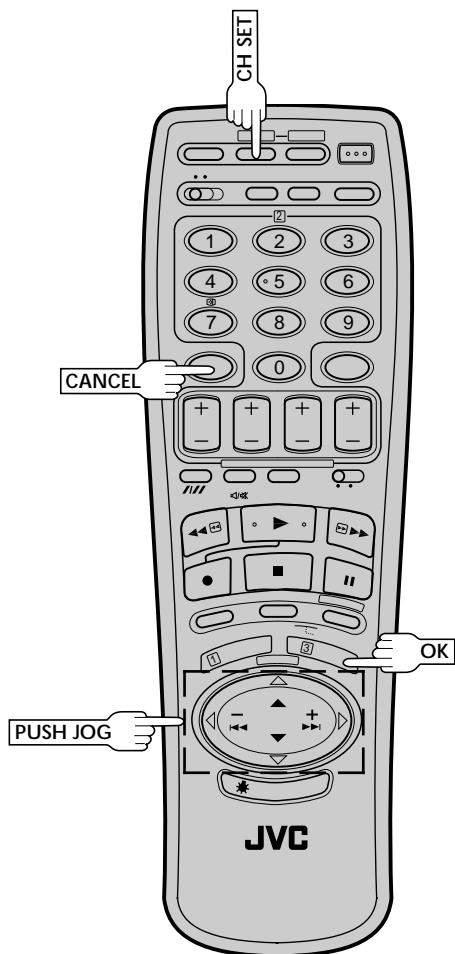
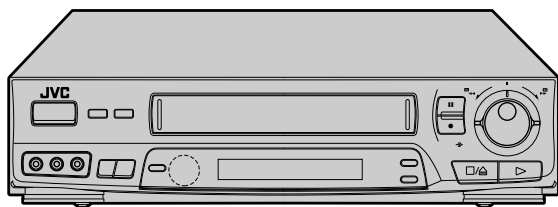

Perform steps 1 and 2 on page 41 to access the Confirmation screen before continuing.

Delete A Channel

1 SELECT ITEM

Press **PUSH JOG** $\Delta \nabla \triangleleft \triangleright$ until the item you want to delete begins blinking.

2 DELETE CHANNEL

Press **CANCEL**.

- The item directly beneath the cancelled one moves up one line.
- Repeat steps 1 and 2 as necessary.

3 CLOSE CONFIRMATION SCREEN

Press **CH SET**.

Change Station Preset Position

1 SELECT ITEM

Press **PUSH JOG** $\Delta \nabla \triangleleft \triangleright$ until the item you want to move begins blinking. Then press **OK** and the station name (ID) and its preset (CH) number begin blinking.

2 SELECT NEW POSITION

Press **PUSH JOG** $\Delta \nabla \triangleleft \triangleright$ to move the station to the new preset position, then press **OK**.

Example: If you moved the station in position 3 to position 7, the stations originally in positions 4-7 each move up one space.

- Repeat steps 1 and 2 as necessary.

3 CLOSE CONFIRMATION SCREEN

Press **CH SET**.

Perform steps 1 and 2 on page 41 to access the Confirmation screen before continuing.

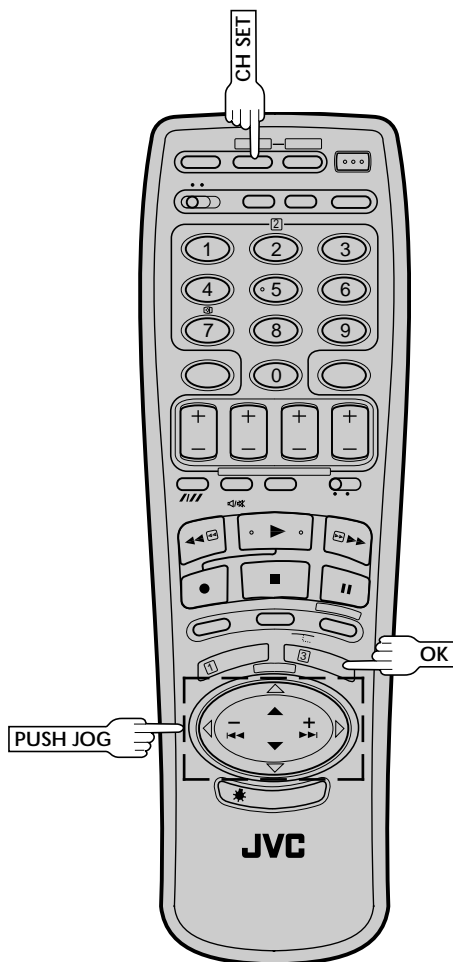
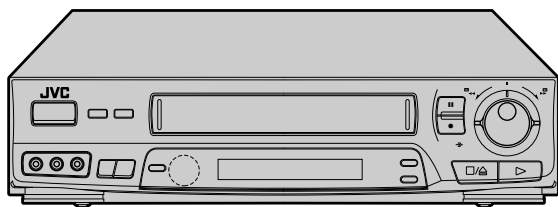

Set Stations (A)

1

SELECT ITEM

Press **PUSH JOG** Δ ∇ \triangleleft \triangleright until the item you want begins blinking. Then press **OK** twice and the station's name (ID) begins blinking.

2

SELECT NEW STATION

Press **PUSH JOG** Δ ∇ until the new station's name (ID) you want to store begins blinking. Registered station names (see pg. 45) appear as you press **PUSH JOG** Δ ∇ .

3

SWITCH STATIONS

Press **OK**.

- Repeat steps 1 through 3 as necessary.

4

CLOSE CONFIRMATION SCREEN

Press **CH SET**.

Set Stations (B)

NOTE:

First perform step 1 of the above procedure.

2

SELECT STATION NAME CHARACTER

Press **PUSH JOG** \triangleright and the first letter of the station name begins blinking.

3

ENTER NEW CHARACTER

Press **PUSH JOG** Δ ∇ to cycle through the characters (A-Z, 0-9, -, *, +, _ (space)) and stop when the desired one is indicated, then press **PUSH JOG** \triangleright to enter. Enter the remaining characters the same way (maximum of 4).

After entering all characters, press **OK**.

- Repeat steps 1 through 3 as necessary.
- If you make a mistake, press **PUSH JOG** \triangleleft until the incorrect character begins blinking. Then enter the correct character by pressing **PUSH JOG** Δ ∇ .

4

CLOSE CONFIRMATION SCREEN

Press **CH SET**.

Perform steps 1 and 2 on page 41 to access the Confirmation screen before continuing.

Fine-Tuning Channels Already Stored

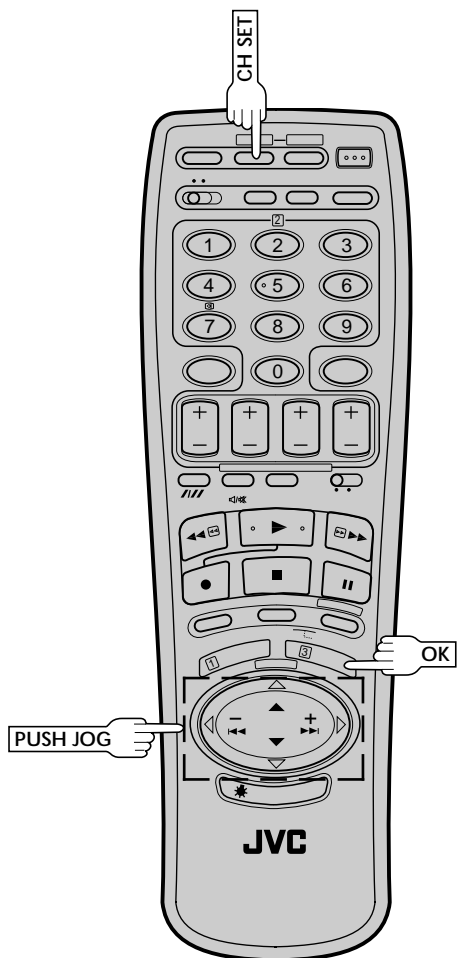
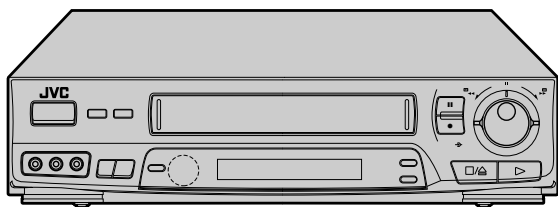

1 SELECT CHANNEL TO FINE-TUNE

Press **PUSH JOG** Δ ∇ \triangleleft \triangleright until the channel you want to tune begins blinking.

2 ACCESS MANUAL CH. SET SCREEN

Press **OK** three times. The Manual Ch. Set screen appears.

3 PERFORM TUNING

Press **PUSH JOG** Δ ∇ until the picture is its clearest. Then press **OK**.

- The Confirmation screen appears.
- Repeat steps 1 through 3 as necessary.

4 CLOSE CONFIRMATION SCREEN

Press **CH SET**.

STATION NAME	ID*
Anglia TV	ANGL
ARD	ARD
ARTE	ARTE
BBC1	BBC1
BBC2	BBC2
Berlin 1	BLN1
Berlin 2	BLN2
Border TV	BORD
Bayern1	BR1
Bayern3	BR3
BRT1	BRT1
BRT2	BRT2
Children Ch	CHLD
Canal +	CH+
CNN	CNN
Channel TV	CHNL
Central TV	CNTR
Channel 4	CH 4
Channel 5	CH 5
DRS	DRS
DR TV	DRTV
DSF	DSF
Euronews	EURN
Euronews	EURO
Eurosports	EURS
France1	FR1
France2	FR2
France3	FR3
Granada TV	GRNA
Grampian TV	GRMP
Hessen1	HR1
Hessen3	HR3
HRT	HRT
HTV	HTV
ITV Network	ITV
Kabelkanal	KABL
London	LNDN
MDR	MDR
MTV	MTV
Nord3	N3
NDR1	NDR1
NDR3	NDR3
NED1	NED1
NED2	NED2
NED3	NED3
Network 2	NET2
NRK	NRK
N-TV	N-TV
Offener Kanal	OKAN
ORF1	ORF1
ORF2	ORF2
ORF3	ORF3
OWL 3	OWL3
Premiere	PRM1
PR07	PR07
RAI1	RAI1
RAI2	RAI2
RAI3	RAI3
RB1	RB1
RB3	RB3
Rikisutvarpid-S	RKPS
RTBF 1	RTB1
RTBF 2	RTB2

STATION NAME	ID*
RTE 1	RTE1
RTL	RTL
RTL 2	RTL2
RTP	RTP
SAT	
SAT 1	SAT1
Scottish TV	SCOT
SC4	SC4
SDR	SDR
SDR1	SDR1
SFB1	SFB1
SFB3	SFB3
SKY	
Sky One	SKY1
Sky Net	SKYN
Sport	SPRT
SR 1	SR1
Super RTL	SRTL
STV Test	STVT
STV 1	STV1
STV 2	STV2
Suedwest3	SW3
SWF 1	SWF1
Schweiz4	SWZ4
TYNE TEES	TEES
Text	TEXT
TF1	TF1
TNT int	TNT
TRT int	TRT
TSI	TSI
TSR	TSR
TSW	TSW
TVE	TVE
TV Polonia	TVPA
TVP 1	TVP1
TVP 2	TVP2
TVS	TVS
TV2	TV2
TV5	TV5
Tele Zurich	TZUR
Ulster TV	ULST
Veronica	VERN
VIVA	VIVA
VIVA2	VIV2
VOX	VOX
VTM	VTM
VT4	VT4
West1	WDR1
West3	WDR3
YLE 1	YLE1
YLE 2	YLE2
Yorkshire TV	YORK
ZDF	ZDF
Zurich 1	ZUR1
3SAT	3SAT

* The ID designator appears on your recorder's front display panel and in the on-screen listing.

Only the main stations are listed. There are in addition many relay stations, and full lists are available from BBC and ITC.

	BBC1	BBC2	ITV	CH4		BBC1	BBC2	ITV	CH4
London & South-East					North-West				
Bluebell Hill	40	46	43	65	Caldbeck	30	34	28	32
Crystal Palace	26	33	23	30	Winter Hill	55	62	59	65
Dover	50	56	66	53	North-East				
Heathfield	49	52	64	67	Bilsdale West Moor	33	26	29	23
Oxford	57	63	60	53	Chatton	39	45	49	42
South-West					Pontop Pike	58	64	61	54
Beacon Hill	57	63	60	53	Scotland				
Caradon Hill	22	28	25	32	Angus	57	63	60	53
Huntshaw Cross	55	62	59	65	Black Hill	40	46	43	50
Redruth	51	44	41	47	Sandale	22	—	—	—
Stockland Hill	33	26	23	29	Caldbeck	—	34	28	32
Channel Islands					Creigkelly	31	27	24	21
Fremont Point	51	44	41	47	Darvel	33	26	23	29
South					Durris	22	28	25	32
Hannington	39	45	42	66	Eitshal	33	26	23	29
Midhurst	61	55	58	68	Keelylang Hill	40	46	43	50
Rowridge	31	24	27	21	Knock More	33	26	23	29
West					Rosemarkie	39	45	49	42
Mendip	58	64	61	54	Rumster Forest	31	27	24	21
East					Selkirk	55	62	59	65
Sandy Heath	31	27	24	21	Wales				
Sudbury	51	44	41	47	Blaenplwyf	31	27	24	21
Tacolneston	62	55	59	65	Carmel	57	63	60	53
Midlands					Llanddona	57	63	60	53
Ridge Hill	22	28	25	32	Moel-y-Parc	52	45	49	42
Sutton Coldfield	46	40	43	50	Presely	46	40	43	50
The Wrekin	26	33	23	29	Wenvoe	44	51	41	47
Waltham	58	64	61	54	Northern Ireland				
North					Brougher Mountain	22	28	25	32
Belmont	22	28	25	32	Divis	31	27	24	21
Emley Moor	44	51	47	41	Limavady	55	62	59	65

Before requesting service for a problem, use this chart and see if you can repair the trouble yourself. Small problems are often easily corrected, and this can save you the trouble of sending your video recorder off for repair.

POWER		
SYMPTOM	POSSIBLE CAUSE	CORRECTIVE ACTION
1. No power is applied to the recorder.	<ul style="list-style-type: none"> • The mains power cord is disconnected. 	Connect the mains power cord.
2. The clock is functioning properly, but the recorder cannot be powered.	<ul style="list-style-type: none"> • "⊖" is displayed on the display panel. 	Press the TIMER button to turn the "⊖" indicator off.
TAPE TRANSPORT		
SYMPTOM	POSSIBLE CAUSE	CORRECTIVE ACTION
1. The tape does not run during recording.	<ul style="list-style-type: none"> • "□□" is displayed on the display panel. 	Press PLAY to turn the "□□" indicator off.
2. The tape stops during rewind or fast-forward.	<ul style="list-style-type: none"> • "M" is displayed on the display panel. 	Press C.MEMORY to deactivate the Counter Memory function and turn the "M" indicator off.
3. The tape will not rewind or fast-forward.	<ul style="list-style-type: none"> • The tape is already fully rewound or fast-forwarded. 	Check the cassette.
PLAYBACK		
SYMPTOM	POSSIBLE CAUSE	CORRECTIVE ACTION
1. The playback picture does not appear while the tape is running.	<ul style="list-style-type: none"> • If you're using the RF OUT connection the TV receiver's preset selector is set to the wrong video preset. the RF switch has been mistakenly set to OFF. • If you're using the AV connection, the TV receiver is not set to the AV mode. 	If you are using the RF OUT connection set the TV receiver to the RF converter preset (UHF 36). (☞ pg. 5) turn the RF switch back to ON. (☞ pg. 5) If you are using the AV connection, set the TV to its AV mode.
2. Noise appears during visual search.	<ul style="list-style-type: none"> • This is normal. 	
3. Noise appears during normal playback.	<ul style="list-style-type: none"> • The automatic tracking mode is engaged. 	Try manual tracking. (☞ pg. 14)
4. Noise appears during slow-motion playback.	<ul style="list-style-type: none"> • The automatic tracking mode is engaged. 	Try manual tracking. (☞ pg. 14)
5. Noise appears during still playback.		Press TV PROG. + or – a few times to remove the noise bars from the screen.
6. Breaks are noticeable in Hi-Fi soundtrack.	<ul style="list-style-type: none"> • Automatic tracking is engaged. 	Engage and adjust tracking manually. (☞ pg. 14)
7. The playback picture is blurred or interrupted while TV broadcasts are clear.	<ul style="list-style-type: none"> • The video heads may be dirty. 	Consult your JVC dealer.
RECORDING		
SYMPTOM	POSSIBLE CAUSE	CORRECTIVE ACTION
1. Recording cannot be started.	<ul style="list-style-type: none"> • There is no cassette loaded, or the cassette loaded has had its Record Safety tab removed. 	Insert a cassette, or using adhesive tape, reseal the slot where the tab was removed.
2. TV broadcasts cannot be recorded.	<ul style="list-style-type: none"> • "AU" has been selected as the input mode. 	Set to the desired preset.

3. Tape-to-tape editing is not possible.	<ul style="list-style-type: none"> ● The source (another video recorder, camcorder) has not been properly connected. ● All necessary power switches have not been turned on. ● The input mode is not correct. 	<p>Confirm that the source is properly connected.</p> <p>Confirm that all units' power switches are turned on. Set the input mode to "AU".</p>
4. Camcorder recording is not possible.	<ul style="list-style-type: none"> ● The camcorder has not been properly connected. ● The input mode is not correct. 	<p>Confirm that the camcorder is properly connected. Set the input mode to "AU".</p>

TIMER RECORDING

SYMPTOM	POSSIBLE CAUSE	CORRECTIVE ACTION
1. Timer recording won't work.	<ul style="list-style-type: none"> ● The clock and/or the timer have been set incorrectly. ● The timer is not engaged. 	<p>Re-perform the clock and/or timer settings. Press TIMER and confirm that "⊖" is displayed on the display panel.</p>
2. On-screen timer programming is not possible.	<ul style="list-style-type: none"> ● Timer recording is in progress. 	<p>Timer programming can't be performed while a timer recording is in progress. Wait until it finishes.</p>
3. "⊖" and "⊞" on the display panel won't stop blinking.	<ul style="list-style-type: none"> ● The timer is engaged but there's no cassette loaded. 	<p>Load a cassette with the Record Safety tab intact, or cover the hole using adhesive tape.</p>
4. The cassette is automatically ejected, and "⊖" and "⊞" on the display panel won't stop blinking.	<ul style="list-style-type: none"> ● The loaded cassette has had its Record Safety tab removed. 	<p>Remove the cassette and cover the hole with adhesive tape, or insert a cassette with the Record Safety tab intact.</p>
5. "⊖" blinks for 10 seconds and the Timer mode is disengaged.	<ul style="list-style-type: none"> ● TIMER has been pressed when there are no programs in memory, or the timer record information has been programmed incorrectly. 	<p>Check the programmed data and re-program as necessary, then press TIMER again.</p>
6. The cassette is automatically ejected, the power shuts off and "⊖" and "⊞" won't stop blinking.	<ul style="list-style-type: none"> ● The end of the tape was reached during timer recording. 	<p>The programme may not have been recorded in its entirety. Next time make sure you have enough time on the tape to record the entire programme.</p>
7. Video Plus+ does not timer-record properly.	<ul style="list-style-type: none"> ● The recorder's preset positions have been set incorrectly. 	<p>Refer to "Guide Channel Set" and re-perform the procedure (Ⓛ pg. 26).</p>

OTHER PROBLEMS

SYMPTOM	POSSIBLE CAUSE	CORRECTIVE ACTION
1. Whistling or howling is heard from the TV during camcorder recording.	<ul style="list-style-type: none"> ● The camcorder's microphone is too close to the TV. ● The TV's volume is too high. 	<p>Position the camcorder so its microphone is away from the TV. Turn the TV's volume down.</p>
2. When scanning presets, some of them are skipped over.	<ul style="list-style-type: none"> ● Those presets have been designated to be skipped. 	<p>If you need the skipped presets, restore them (Ⓛ pg. 41).</p>
3. The preset cannot be changed.	<ul style="list-style-type: none"> ● Recording is in progress. 	<p>Press PAUSE to pause the recording, change presets, then press PLAY to resume recording.</p>
4. The remote control won't operate my TV.	<ul style="list-style-type: none"> ● The TV/VCR switch is in the wrong position. 	<p>Set the switch to TV.</p>

PLAYBACK

- Q. What happens if the end of the tape is reached during playback or search?**
A. The tape is automatically rewound to the beginning.
.....
- Q. Can the video recorder indefinitely remain in the still mode?**
A. No. It stops automatically after 5 minutes to protect the heads.
.....
- Q. During search, slow, still and frame-by-frame playback, I can't hear any audio. What's the problem?**
A. This is normal.
.....
- Q. When returning from multi-speed search to normal playback, the picture is disturbed. Should I be concerned about this?**
A. No, it is normal.
.....
- Q. Noise bars appear during multi-speed search. What's the problem?**
A. This is normal.
.....
- Q. Other than preventing further recording, what effect does removing the Record Safety tab have?**
A. It disables marking of index codes.
.....
- Q. Sometimes, during Index Search, the video recorder can't find the programme I want to see. Why not?**
A. There may be index codes too close together.
.....

RECORDING

- Q. When I pause and then resume a recording, the end of the recording before the pause is overlapped by the beginning of the continuation of recording. Why does this happen?**
A. This is normal. It reduces distortion at the pause and resume points.
.....
- Q. Can the video recorder indefinitely remain in the Record-Pause mode?**
A. No. The video recorder shuts off automatically after 5 minutes to protect the heads.
.....
- Q. What happens if the tape runs out during recording?**
A. The video recorder automatically rewinds it to the beginning.
.....

TIMER RECORDING

- Q. "REC" and "⊖" remain lit on the display panel. Is there a problem?**
A. No. This is a normal condition for a timer recording in progress.
.....
- Q. Can I program the timer while I'm watching a tape or a TV broadcast?**
A. You won't see the picture as it is replaced by the on-screen menu, but the audio from the program or tape you're viewing can be heard.
.....

ATTENTION:

This recorder contains microcomputers. External electronic noise or interference could cause malfunctioning. In such cases, switch the recorder off and unplug the mains power cord. Then plug it in again and turn the recorder on. Take out the cassette. After checking the cassette, operate the unit as usual.

List Of Terms

This guide serves as a quick way to locate frequently used terms and on-screen display names. The first page on which the term appears is listed. Most terms appear more than once in the instruction manual.

A

A/B Code Switch	pg. 19
A-Code Signals	pg. 19
Aerial	pg. 4
Audio Dubbing	pg. 38
Audio Monitor	pg. 18
Auto Channel Set	pg. 8
Auto Clock Set	pg. 9
Auto SP/LP Timer	pg. 33
AUX	pg. 27
AV	pg. 4
AV Connection	pg. 4

B

B-Code Signals	pg. 19
B.E.S.T. (Biconditional Equalised Signal Tracking)	pg. 21

C

Cancel	pg. 27
Cassette Adapter	pg. 11
Channel Set Mode Menu	pg. 8
Clock	pg. 9
Clock Set	pg. 9
Contents	pg. 1
Counter Memory	pg. 17
Counter Reset	pg. 17

D

Daily	pg. 29
Delete A Channel	pg. 42
Display Panel	pg. 54

E

Editing	pg. 34
---------------	--------

F

Fine Tuning	pg. 44
Frame-By-Frame Playback	pg. 12
Front View	pg. 51

G

Guide Channel (GUIDE CH)	pg. 26
--------------------------------	--------

H

Head Cleaning	pg. 2
High-Speed Search	pg. 13

I

Illumi Guide	pg. 28
Index Code	pg. 16
Index Search	pg. 16
Instant ReView	pg. 14
Instant Timer Recording (ITR)	pg. 25

J

Just Clock	pg. 9
Jog Dial	pg. 12

L

Load A Cassette	pg. 11
-----------------------	--------

M

Manual Channel Set	pg. 41
Manual Clock Set	pg. 10
Manual Tracking	pg. 14
Moisture Condensation	pg. 2
Multi-Brand Remote (MBR) Control Setting	pg. 40

N

Next-Function Memory	pg. 15
NICAM	pg. 24
NTSC Playback	pg. 18

O

On-Screen	pg. 23
-----------------	--------

P

Programme Delivery Control (PDC) Playback	pg. 33
PlusCode™	pg. 27
Preset Position	pg. 8
Programme Screen	pg. 30

R

Random Assemble Editing	pg. 36
Rear View	pg. 54
Record Safety Tab	pg. 20
Recording	pg. 20
Repeat Playback	pg. 15
RF Connection	pg. 4

S

Scart Connector	pg. 4
Scene Finder	pg. 17
Shuttle Ring	pg. 12
Slow Motion	pg. 12
Specifications	pg. 55
Still Picture	pg. 12

T

Tape Position Indicator	pg. 15
Tape Speed	pg. 20
Timer Programming	pg. 30
Timer Recording	pg. 26
Timer Warning	pg. 32
Tracking	pg. 14
Tuner	pg. 8
TV Brand	pg. 40

V

Variable-Speed Search	pg. 13
Video Plus+	pg. 26

W

Weekly	pg. 29
--------------	--------

FRONT VIEW

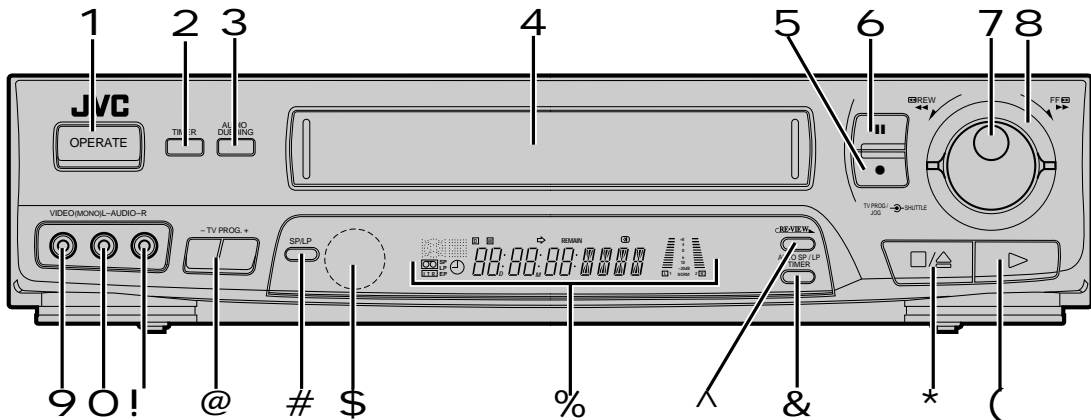





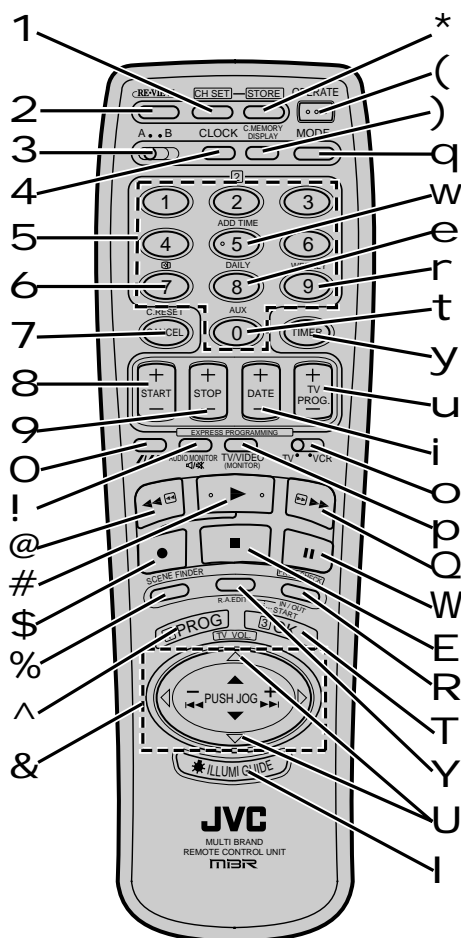

















- 1 **OPERATE Button** turns recorder on/off (loading a cassette also turns power on). ☞ pg. 5
- 2 **TIMER Button** engages timer standby mode. ☞ pg. 29
- 3 **AUDIO DUBBING Button** engages Audio Dubbing mode. ☞ pg. 38
- 4 **Cassette Loading Slot** is where cassette is inserted; door closes, "cassette loaded" indicator lights up on front display panel.
- 5 **RECORD Button** starts regular recording (press once), Instant Timer Recording (press twice); sets duration of ITR. ☞ pg. 20
- 6 **PAUSE Button** stops tape temporarily during recording.; stops tape temporarily during playback; plays back frame by frame with each additional press. ☞ pg. 12
- 7 **TV PROG. Dial** scans to desired preset during Stop mode. ☞ pg. 20
JOG Dial plays back frame by frame during Still or Play mode. ☞ pg. 12
- 8 **SHUTTLE Ring** rewinds or fast-forwards tape during Stop mode; performs forward and reverse slow-motion and search during Still or Play mode. ☞ pg. 12
- 9 **VIDEO Input Connector** enables easy connection of video output from another recorder or camcorder for editing. ☞ pg. 35
- 0 **AUDIO Input Connector [L]** enables easy connection of audio output (mono) from another recorder, camcorder or other source for editing. ☞ pg. 35
- ! **AUDIO Input Connector [R]** enables easy connection of audio output (Hi-Fi) from another recorder, camcorder or other source for editing. ☞ pg. 35
- @ **TV PROG. +/- Buttons** select preset. ☞ pg. 8
- # **SP/LP Button** selects tape speed. ☞ pg. 20
- \$ **Infrared Beam Receiving Window** is where remote control should be aimed when in use.
- % **Display Panel** provides clear view of various displays and indicators. ☞ pg. 54
- ^ **REVIEW Button** "reviews" timer-recorded programme. ☞ pg. 14
- & **AUTO SP/LP TIMER Button** engages Auto SP/LP Timer for automatic switching from SP to LP mode during recording. ☞ pg. 33
- * **STOP/EJECT Button** stops tape; ejects tape during Stop mode. ☞ pg. 11
- (**PLAY Button** plays back tape; cancels Pause, Still, Slow, Search modes. ☞ pg. 11

REMOTE CONTROL



- 1 **CH SET Button** accesses Ch. Set Mode Menu screen; closes Confirmation screen. pg. 8
- 2 **REVIEW Button** — same as button on recorder. pg. 14
- 3 **A/B CODE Switch** enables setting of recorder to respond to A- or B-code command signals. pg. 19
- 4 **CLOCK Button** accesses Clock Set screen. pg. 9
- 5 **NUMBER Keys** are used in channel selection, timer programming, external source recording. pg. 20
- 6 **(PDC) Button** enables/disables PDC recording. pg. 33
- 7 **CANCEL Button** erases previously entered data in on-screen selection menus. pg. 27
C.RESET Button resets counter to 0:00:00. pg. 17
- 8 **START +/- Button** accesses Program screen; inputs of programme Start Time. pg. 30
- 9 **STOP +/- Button** inputs programme Stop Time. pg. 31
- **SP/LP Button** selects tape speed. pg. 20
Digit Entry Button is used in controlling connected TV. pg. 40
- ! **AUDIO MONITOR Button** changes output sound mode. pg. 18
TV Mute Button mutes sound of connected TV. pg. 40
- @ **Rewind [REW] Button** rewinds tape; initiates high-speed reverse search. pg. 11
- # **PLAY Button** — same as button on recorder. pg. 11
- \$ **RECORD Button** — same as button on recorder. pg. 20
- % **SCENE FINDER Button** initiates cycle of 5-second forward high-speed search and 10-minute fast-forward (on counter). pg. 17
- ^ **PROG Button** accesses Timer Programming screen. pg. 28
- & **PUSH JOG $\triangle \nabla < \triangleright$ Button** is used for selection in on-screen menus. pg. 8
PUSH JOG $< \triangleright$ Button sets preset of TV pg. 40; initiates functions such as Index Search, variable-speed search, frame by frame playback. pg. 12
- * **STORE Button** is used when storing channels manually. pg. 41
C.MEMORY Button engages Counter Memory mode. pg. 17

- (**OPERATE Button** — same as button on recorder.  pg. 5
-) **DISPLAY Button** switches display between time, date, counter readings.  pg. 16
- q **MODE Button** accesses/closes On-Screen/B.E.S.T. screen.  pg. 21
- w **ADD TIME Button** adds time to end of recording (5 minutes each time button is pressed.)  pg. 29
- e **DAILY Button** enables timer recording of daily serials.  pg. 29
- r **WEEKLY Button** enables timer recording of weekly serials.  pg. 29
- t **AUX Button** sets recorder's input mode.  pg. 35
- y **TIMER Button** — same as button on recorder.  pg. 29
- u **TV PROG. +/- Button** selects preset.  pg. 8
- i **DATE +/- Button** inputs date of programme for timer recording.  pg. 31
- o **TV/VCR Switch** enables remote control of VCR or connected TV.  pg. 40
- p **TV/VIDEO Button** switches control between TV and VCR.  pg. 40
- Q **Fast Forward [FF] Button** fast-forwards tape; initiates high-speed forward search.  pg. 11
- W **PAUSE Button** — same as button on recorder.  pg. 12
- E **STOP Button** — same as button on recorder.  pg. 11
- R **PROG CHECK Button** accesses Program screens (next program's information screen appears each time button is pressed).  pg. 32
- IN/OUT Button** registers edit-in and edit-out points in memory during R.A. Edit mode.  pg. 36
- T **OK Button** enters selections made in on-screen menus.  pg. 8
- START Button** starts automatic editing.  pg. 37
- Y **R.A. EDIT Button** engages R.A. Edit mode.  pg. 36
- U **TV VOL Δ / ∇ Button** controls volume of connected TV.  pg. 40
- I **ILLUMI GUIDE Button** engages Illumi-Guide mode.  pg. 28

Installing Batteries

- 1 Open the battery compartment cover.
- 2 Insert 2 "R6"-size batteries (provided) in the correct directions.
- 3 Replace the cover.

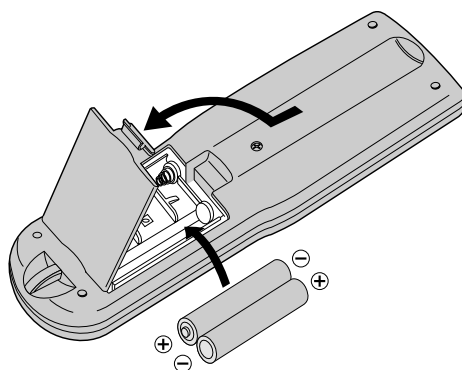

How To Use

The remote control can operate most of your video recorder's functions, as well as basic functions of TV sets of JVC and other brands.  pg. 40.

- Point the remote control toward the sensor window.
- The maximum operating distance of the remote control is about 8 m.

NOTE:

If for some reason the remote control doesn't work properly, remove its batteries, wait a short time and then try again.

REAR VIEW

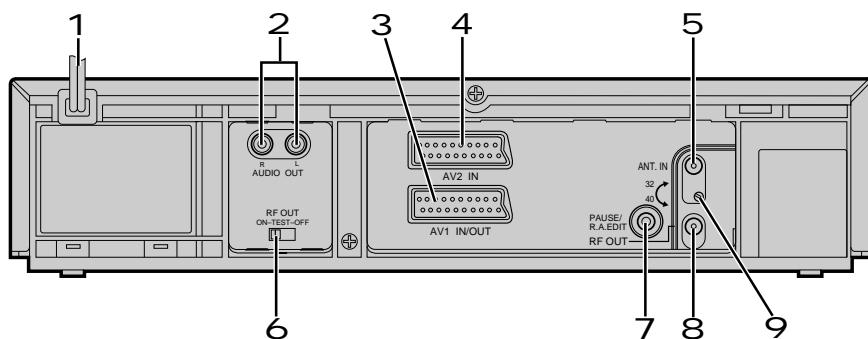

- 1 **Mains Power Cord** supplies power to recorder. ☞ pg. 4
- 2 **AUDIO OUT (L/R) Connectors** enable connection of audio cassette recorder, TV or second video recorder for dubbing. ☞ pg. 7
- 3 **AV1 IN/OUT SCART Connector** enables AV connection to TV or second recorder; input recordable when "AU 1" selected. ☞ pg. 4
- 4 **AV2 IN Connector** enables connection of satellite receiver or second recorder; input recordable when "AU 2" selected. ☞ pg. 6
- 5 **ANT. IN Connector** enables connection of aerial. ☞ pg. 4
- 6 **RF OUT Switch** enables operation via RF connection or AV connection; activates test pattern when tuning TV receiver for video preset. ☞ pg. 5
- 7 **Remote PAUSE/R.A. EDIT Connector** enables connection to second recorder equipped with Remote PAUSE or R.A. EDIT Connector, or to JVC camcorder equipped with Master Edit Control, for easy editing. ☞ pg. 35
- 8 **RF OUT Connector** enables connection to aerial terminal of TV receiver. ☞ pg. 4
- 9 **RF Output Channel Adjustment Screw** enables adjustment of output channel if UHF channel 36 is used in your area. ☞ pg. 5

DISPLAY PANEL

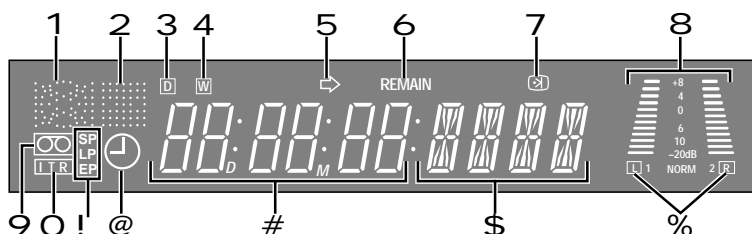

1 and 2 Symbolic Mode Indicators

PLAY:	▶	STILL:	▶
FF:	⏩	FORWARD SLOW:	▶
REW:	⏪	STILL:	◀
FF VARIABLE SHUTTLE SEARCH:	▶ ⏩ *	REVERSE SLOW:	◀
REW VARIABLE SHUTTLE SEARCH:	⏪ ◀ *	RECORD:	⊙
REVERSE PLAY:	◀	RECORD PAUSE:	⊙
		AUDIO DUBBING:	⊕
		AUDIO DUBBING PAUSE:	⊕

* The indicator will blink during turbo search.

- 3 **"DAILY" Program Mark** lights when recorder has been programmed to record daily serial. ☞ pg. 29
- 4 **"WEEKLY" Program Mark** lights when recorder has been programmed to record weekly serial. ☞ pg. 29
- 5 **Start Time/Stop Time Indicator** separates Start Time and Stop Time of timer recording on Display Panel. ☞ pg. 29
- 6 **Tape Remaining Time Indicator** displays time remaining on tape when certain buttons are pressed. ☞ pg. 16
- 7 **PDC Indicator** lights when PDC has been engaged for timer recording. ☞ pg. 33

- 8 **B.E.S.T. Picture System Display** lights from bottom to top while B.E.S.T. is active. ☞ pg. 21
- Audio Level Indicator** displays audio input and output levels.
- 9 **"Cassette Loaded" Mark** lights once a cassette is inserted; remains lit until cassette ejected or power turned off.
- ⊙ **Instant Timer Recording Indicator** lights when ITR initiated; remains lit until ITR finishes. ☞ pg. 25
- ! **Tape Speed Indicators** display mode of recording; light during Record or Play mode. ☞ pg. 20
- @ **"Timer" Indicator** lights when TIMER has been pressed to engage Timer mode. ☞ pg. 29
- # **Counter** shows time elapsed since playback or recording began.
- REMAIN** displays time remaining from current tape position to end of tape.
- Clock Display** shows current time. ☞ pg. 9
- * Counter, REMAIN and Clock Display appear alternately when **DISPLAY** is pressed.
- \$ **Channel Display** shows station name being received and its preset position.
- Mode** shows external input mode selected.
- % **Audio Mode Indicator** displays audio output mode currently selected.

GENERAL

Power requirement	: AC 220 – 240 V~, 50/60 Hz
Power consumption	: 24 W
Temperature	
Operating	: 5°C to 40°C
Storage	: -20°C to 60°C
Operating position	: Horizontal only
Dimensions (WxHxD)	: 400 x 94 x 340 mm
Weight	: 4.3 kg
Format	: VHS PAL standard
Maximum recording time	
(SP)	: 240 min. with E-240 video cassette
(LP)	: 480 min. with E-240 video cassette

VIDEO/AUDIO

Signal system	: PAL-type colour signal and CCIR monochrome signal, 625 lines/50 fields
Recording system	: DA4 (Double Azimuth) helical scan system
Signal-to-noise ratio	: 45 dB
Horizontal resolution	: 250 lines
Frequency range	: 70 Hz to 10,000 Hz (Normal audio) 20 Hz to 20,000 Hz (Hi-Fi audio)
Input/Output	: 21-pin scart connector x 2 (IN/OUT x 1, IN x 1) RCA connector x 1 (IN x 1, OUT x 1)

TUNER/TIMER

TV channel storage capacity	: 99 positions (+AUX position "AU")
Tuning system	: Frequency synthesized tuner
Channel coverage	: UHF channels 21 – 69 (470 – 862 MHz)
Aerial output	: UHF channel 36 (Adjustable 32 – 40)
Memory backup time	: Approx. 3 min.

ACCESSORIES

Provided accessories	: RF cable, Infrared remote control unit, "R6" battery x 2, 21-pin SCART cable
----------------------	---

Specifications shown are for SP mode unless otherwise specified.

E. & O.E. Design and specifications subject to change without notice.

