

STERILCO TEMPERATURE CONTROL UNIT
SERVICE AND INSTRUCTION MANUAL

MODEL 6018-AF (6018-P)
MODEL 6018-AG (6018-K)

Engineered and manufactured by INDUSTRIAL CONTROL DIVISION
STERLING, INC.
5200 West Clinton Ave. Milwaukee, Wisconsin 53223
Manufacturers of Temperature Control Equipment since 1916

Please note that our address and phone information has changed. Please reference this page for updated contact information.



These manuals are obsolete and are provided only for their technical information, data and capacities. Portions of these manuals detailing procedures or precautions in the operation, inspection, maintenance and repair of the products may be inadequate, inaccurate, and/or incomplete and shouldn't be relied upon. Please contact the ACS Group for more current information about these manuals and their warnings and precautions.

Parts and Service Department

The ACS Customer Service Group will provide your company with genuine OEM quality parts manufactured to engineering design specifications, which will maximize your equipment's performance and efficiency. To assist in expediting your phone or fax order, please have the model and serial number of your unit when you contact us. A customer replacement parts list is included in this manual for your convenience. ACS welcomes inquiries on all your parts needs and is dedicated to providing excellent customer service.

For immediate assistance, please contact:

- North, Central and South America, 8am – 5pm CST +1 (800) 483-3919 for drying, conveying, heating and cooling and automation. For size reduction: +1 (800) 229-2919.
North America, emergencies after 5pm CST (847) 439-5855
North America email: acsuscanadacustserv@corpemail.com
- Mexico, Central & South America
Email: acslatinamericacustserv@corpemail.com
- Europe, Middle East & Africa +48 22 390 9720
Email: acseuropecustserv@corpemail.com
- India +91 21 35329112
Email: acsindiacustserv@corpemail.com
- Asia/Australia +86 512 8717 1919
Email: acsasiacustserv@corpemail.com

Sales and Contracting Department

Our products are sold by a worldwide network of independent sales representatives. Contact our Sales Department for the name of the sales representative nearest you.

Let us install your system. The Contract Department offers any or all of these services: project planning; system packages including drawings; equipment, labor, and construction materials; and union or non-union installations.

For assistance with your sales or system contracting needs please Call:

North, Central and South America +1 (262) 641-8600 or +1 (847) 273-7700 Monday–Friday, 8am–5pm CST

Europe/Middle East/Africa +48 22 390 9720

India +91 21 35329112

Asia/Australia +86 512 8717 1919

Facilities:

ACS offers facilities around the world to service you no matter where you are located. For more information, please visit us at www.acscorporate.com

United States:

ACS Schaumburg – Corporate Offices

1100 E. Woodfield Road
Suite 588
Schaumburg, IL 60173
Phone: + 1 847 273 7700
Fax: + 1 847 273 7804

ACS New Berlin – Manufacturing Facility

2900 S. 160th Street
New Berlin, WI 53151
Phone : +1 262 641 8600
Fax: + 1 262 641 8653

Asia/Australia:

ACS Suzhou

109 Xingpu Road SIP
Suzhou, China 215126
Phone: + 86 8717 1919
Fax: +86 512 8717 1916

Europe/Middle East/Africa:

ACS Warsaw

Ul. Działkowa 115
02-234 Warszawa
Phone: + 48 22 390 9720
Fax: +48 22 390 9724

India

ACS India

Gat No. 191/1, Sandbhor Complex
Mhalunge, Chakan, Tal Khed,
Dist. Pune 410501, India
Phone: +91 21 35329112
Fax: + 91 20 40147576

MODEL 6018-AF & 6018-AG

DESCRIPTION

Continued

CIRCULATING CONNECTION LINES:

On the Model 6018-AF, the water supply and drain line are 1" N.P.T. The delivery and return lines are 2" N.P.T. and the Blow-Off lines are 1/2" N.P.T.

On the Model 6018-AG, the water supply, drain line, delivery and return lines are 2" N.P.T. and the Blow-Off lines are 1/2" N.P.T.

Hoses must be adequate to withstand the maximum temperatures and pressures at which the unit is to be operated.

Hoses, fittings and channel connections in the mold or other equipment being controlled should be at least 1 1/2" in order not to restrict the flow of water through the circuit; if the flow is restricted by too small of connecting hoses or hoses with excess bends, loops, etc., the pressure will increase and the flow through the process will be greatly reduced.

HEATER:

The Heater is a three phase immersion heater of low watt density construction to minimize fouling and to promote longer heater life. It is vertically suspended to eliminate any bending stress on the elements and to simplify the venting of air from the heater tank.

PNEUMATIC CONTROLLER:

This Pneumatic Indicating Temperature Controller is designed for proportioning temperature control. The Controller provides continuous read-out of the actual water temperature being sent to your process. The temperature and set point indication are visible through separate windows on the front of the control.

PNEUMATIC VALVE:

This pneumatic modulating valve automatically releases an amount of warm water from the unit making room for the equivalent amount of fresh water to enter the system from the plant water supply. The fresh water enters a blending chamber within the unit to be mixed with the circulating water until the thermostat has been satisfied. The 6018-AF uses a 1" cooling control valve, and the 6018-AG uses a 2" cooling control valve.

PRESSURE REDUCING REG. VALVE: (6018-AG)

This Pressure Reducing Regulator Valve reduces the cold water supply pressure to approximately 25 PSI, so that the modulating valve will be protected against an excessive pressure differential.

MODEL 6018-AF & 6018-AG

TROUBLE SHOOTING (CONT'D.)

- 4) Perhaps it might be well to check the water supply pressure. If the water supply pressure drops below the setting of the pressure switch, the unit will stop.

- 5) High back pressure from the drain could easily cause a limited ability to cool, since the unit depends upon the pressure differential between the water supply and drain for the amount of cooling which it can provide. See important notice on page



mc 125

Precision
Temperature/Process
Controllers with
Overshoot Suppression

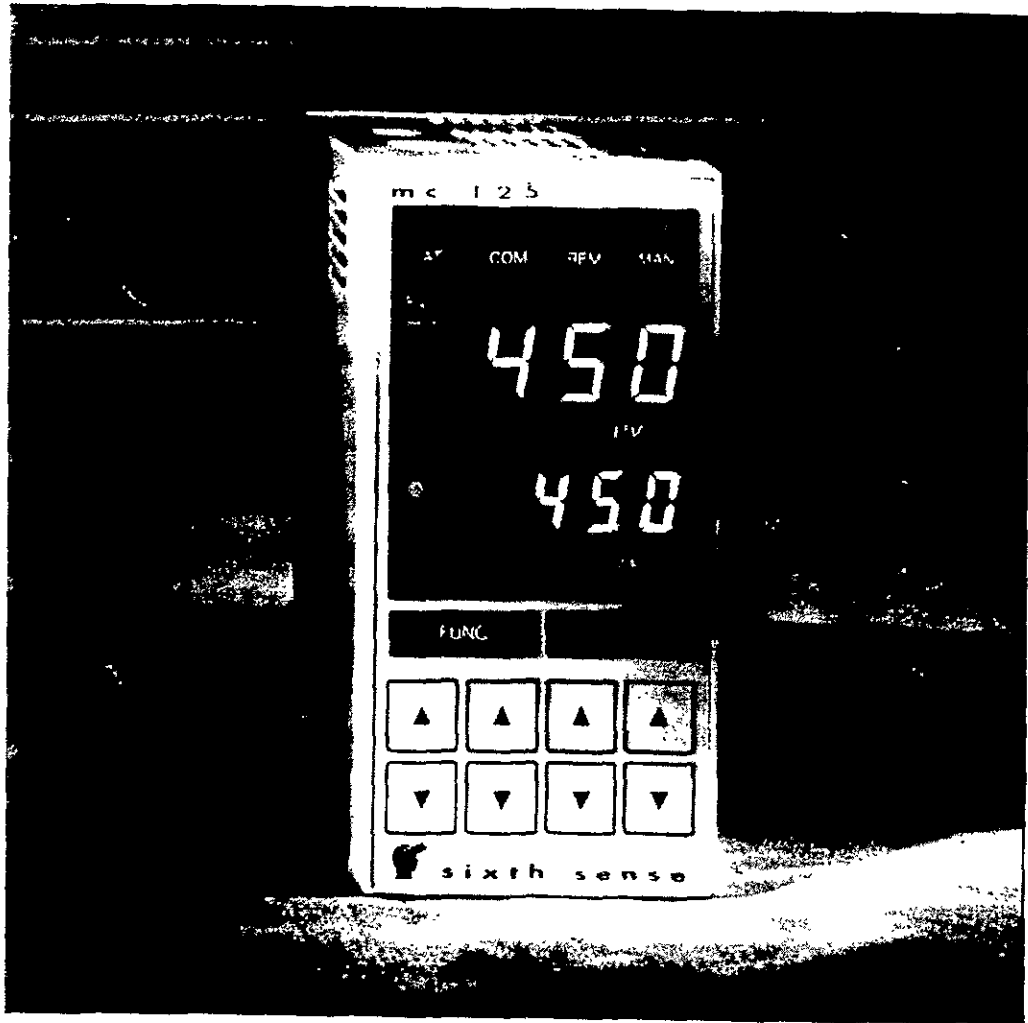

INSTRUCTION MANUAL

Sixth Sense, a Division of:



TOTAL
TEMPERATURE
INSTRUMENTATION
INCORPORATED

TABLE OF CONTENTS

	<u>Page Number</u>
1.0 Introduction.....	1
1.1 Model Number and Condition Verification.....	2
2.0 Installation.....	3
2.1 Mounting.....	3
2.2 Wiring (Rear Terminal Diagram).....	4
2.3 Wiring Examples.....	5
3.0 Front Panel Layout (Indicators and Keys).....	6
4.0 Operation.....	7
4.1 Menus and Flow Chart.....	7
4.2 Entering Menus (Viewing Parameters).....	7
4.3 Changing Parameter Values.....	8
4.4 Parameter Definitions (PV and SV).....	8
4.5 Parameter Definitions (Function Menu).....	9
Process Variable Sensor Correction.....	9
Main Control Proportional Band.....	9
Main Control Reset Time (Integral Time).....	9
Main Control Rate Time (Derivative Time).....	9
Main Control Proportional Cycle Time.....	9
ON/OFF Main Control Sensitivity.....	10
Dead Band.....	10
Main Control Manipulated Variable Display..	10
Main Control Input and Output.....	11
Low and High Limit Input Range.....	12
Decimal Point Position.....	12
Temperature Units.....	12
Buzzer.....	12
Lock Function.....	12
4.6 Parameter Definitions (Mode Menu).....	13
Mode Selection.....	13
Manual Mode Operation.....	13
Autotuning.....	14
5.0 Options.....	15

2.0 INSTALLATION

2.1 Mounting

The MC-125 is a flush panel mounted instrument. To mount your controller(s), first verify that the depth of your panel will accommodate the length of the MC-125 (100 mm). Next, cut a rectangular hole in the panel (height=92 mm width=45 mm). Insert the unit through the front of the panel. The controllers bezel should catch and not feed through the cutout. If the fit seems too tight, remove more from the panel, being careful not to exceed tolerances shown below. Clip the two mounting brackets, included with your controller, to the top and bottom of the unit. Each clip should fit into the two holes on top and bottom. With a screwdriver, turn the screws until they just touch the panel. Be sure the controllers face plate is level and tighten the screws. Do not over-tighten. Your controller should now be firmly set and ready for wiring.

Dimensions (Units are mm)

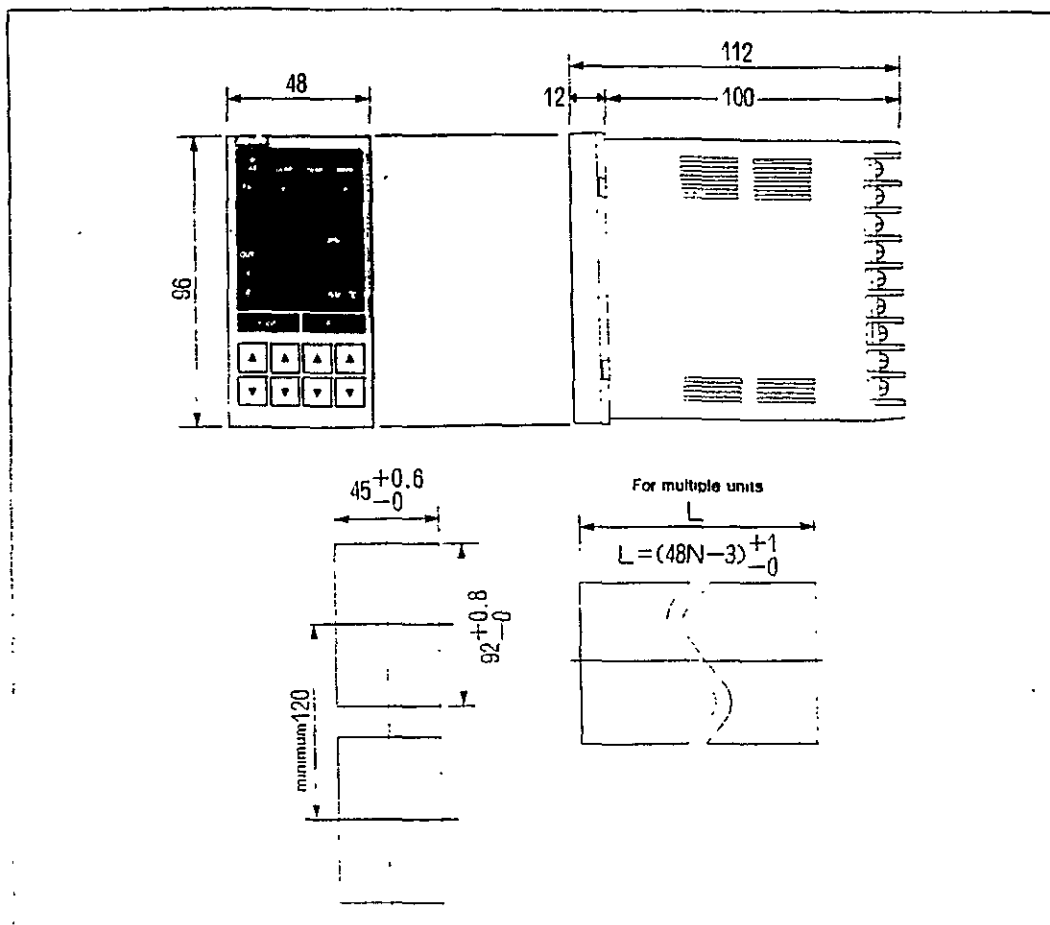

2.3 Wiring Examples

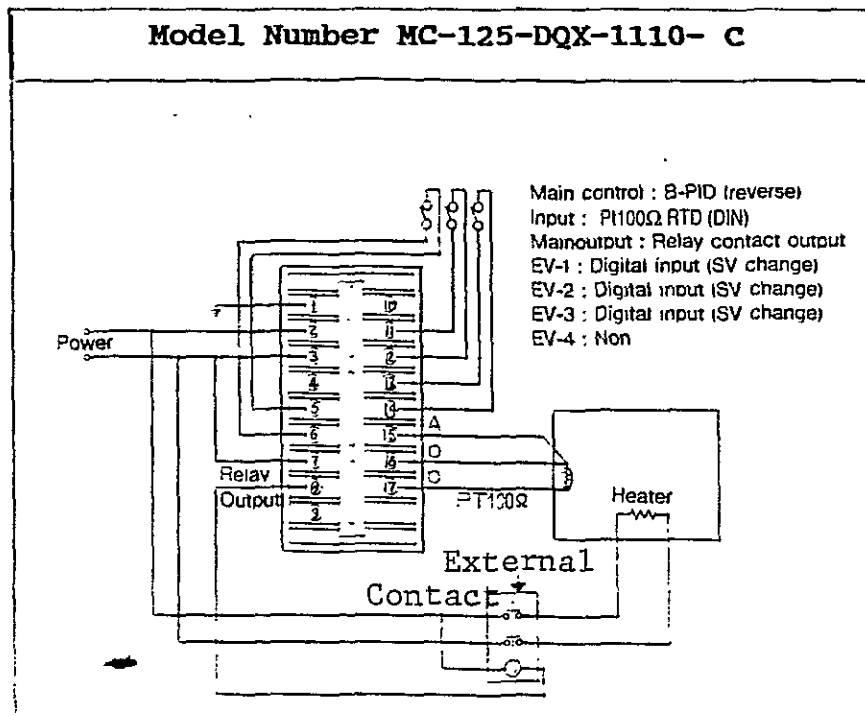
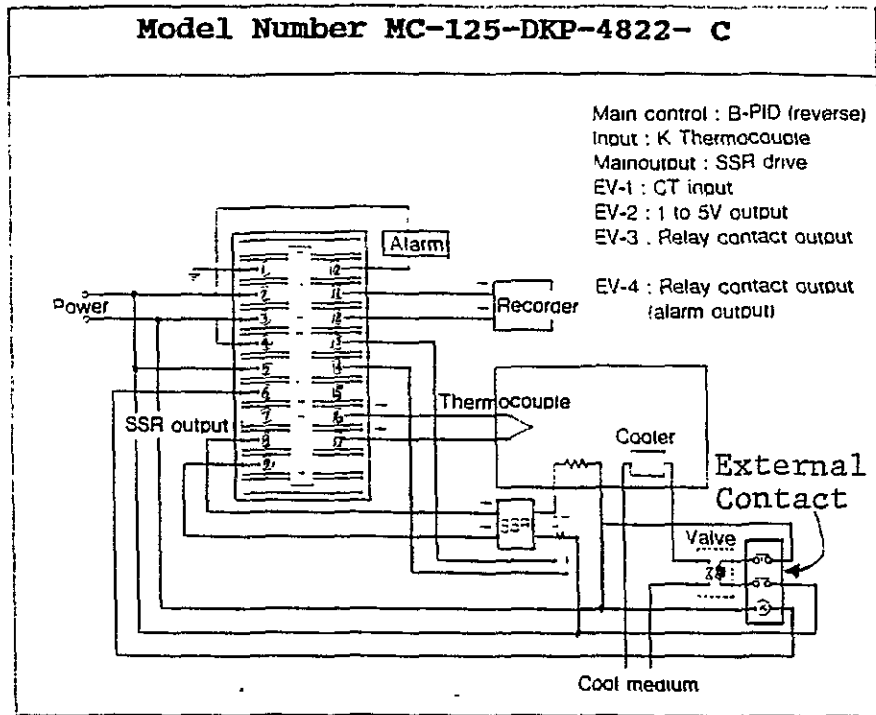



4.0 OPERATION

4.1 Menus and the Operation Manual (Programming Flowchart)

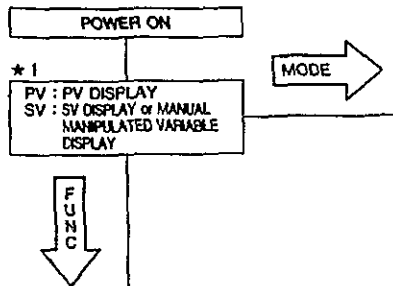
When the Controller is initially powered, the two numbers displayed represent the process variable and the setpoint variable. This is termed the PV-SV Display. See top left of Operation Manual. If manual output is activated the SV display section will represent manual manipulated variable.



There are two main menus in the MC-125 controller, the **Function** menu and the **Mode** menu. These menus are illustrated starting from the top left corner of the Operation Manual (fold out Programming flowchart). The  and  arrows indicate their direction through the flow chart. The Function menu contains information on the manual tuning of your controller and the Mode menu allows you to turn on the Automatic tuning feature (Autotuning).

4.2 * Entering the Mode Menu (Viewing Parameters)

- Turn the controller on and obtain the PV-SV display.
- Press the MODE key once.
- MODE should appear in the top (PV) display section.
- * You have now entered the Mode menu
- Press the MODE key again to advance to the next parameter in the Mode menu. Repeat.
- * To exit the Mode menu press the FUNC key.

* Entering the Function Menu (Viewing Parameters)

- Turn the controller on and obtain PV-SV display.
- Press and hold the FUNC key until PV-S appears in the PV display section.
- * You have now entered the Function menu.
- Press the FUNC key again to advance to the next parameter in the Function menu. Repeat. The top symbol (PV display section) indicates the parameter name, while the bottom (SV display section) is the value assigned to this parameter.
- * To exit the Function menu press the MODE key.

4.5 Parameter Definitions (Function Menu)

Pu-5 **Process Variable Sensor Correction:** This parameter is used when discrepancies occur between actual and measured process variable. Example: If you know the temperature is 5 degrees less than the sensor is reading, a -5 can be entered into this parameter setting.

Range

Thermocouple.....+- 999 (°C/°F)
RTD.....+- 99.9 (°C/°F)
Current/Voltage.....+- 10.0% of full scale

PID CONTROL

P-1 **Main Control Proportional Band:** Range where output is proportional to the amount of deviation from setpoint. Set as a percentage of full scale determined by **SEtI** and **SEtH**. **P-1** is displayed only for PID control. Range is .1 to 999.9%.

I-1 **Main Control Reset Time (Integral Time):** When proportional operation is used, steady state error or offset often occurs. Integral time compensates for this steady state error. The larger the value entered, the more time it takes for this action to occur. Too small a value may cause oscillation.

- * Range is 0 to 9999 sec.
- * Integral time is off when set to '0'.
- * Integral time is the same for main and sub-control.
- * **I-1** is displayed only for PID control

d-1 **Main Control Rate Time (Derivative Time):** Rate time is used to determine how fast the process variable changes in time. This function anticipates the process, based on its present characteristics and acts on this prediction accordingly. The amount of prediction is determined by the value entered.

- * Range is 0 to 9999 sec.
- * Derivative action is off when set at '0'.
- * Derivative time is the same for main and sub-control.
- * **d-1** is displayed only for PID control.

t-1 **Main Control Proportional Cycle Time:** With a relay or SSR drive, the output is either on or off. This setting is the amount of time for one complete on/off cycle.

- * Range is 1 to 999 sec
- * Factory preset values
 - SSR Drive - 2 sec
 - Relay - 20 sec
- * **t-1** is displayed only for PID, relay or SSR drive output.

Parameter Definitions (Function Menu) Continued

TYPE Main Control Input/Output: This parameter displays the codes for control type, input type, and output type.

- * The first digit is either a '1' or '2', which indicates either temperature sensing input or analog input. This digit cannot be changed. The last digit indicates main output type and cannot be changed.
- * ON/OFF control cannot be selected when the first digit is a 2 (Current or Voltage Output).
- * "Normal Operation" (direct acting) refers to control where output action decreases the process variable.
"Reverse Operation" (reverse acting) refers to control where output action increases the process variable.
- * PID Control Types
Type A: Normal PID Control.
Type B: PID Control with Overshoot Suppression.

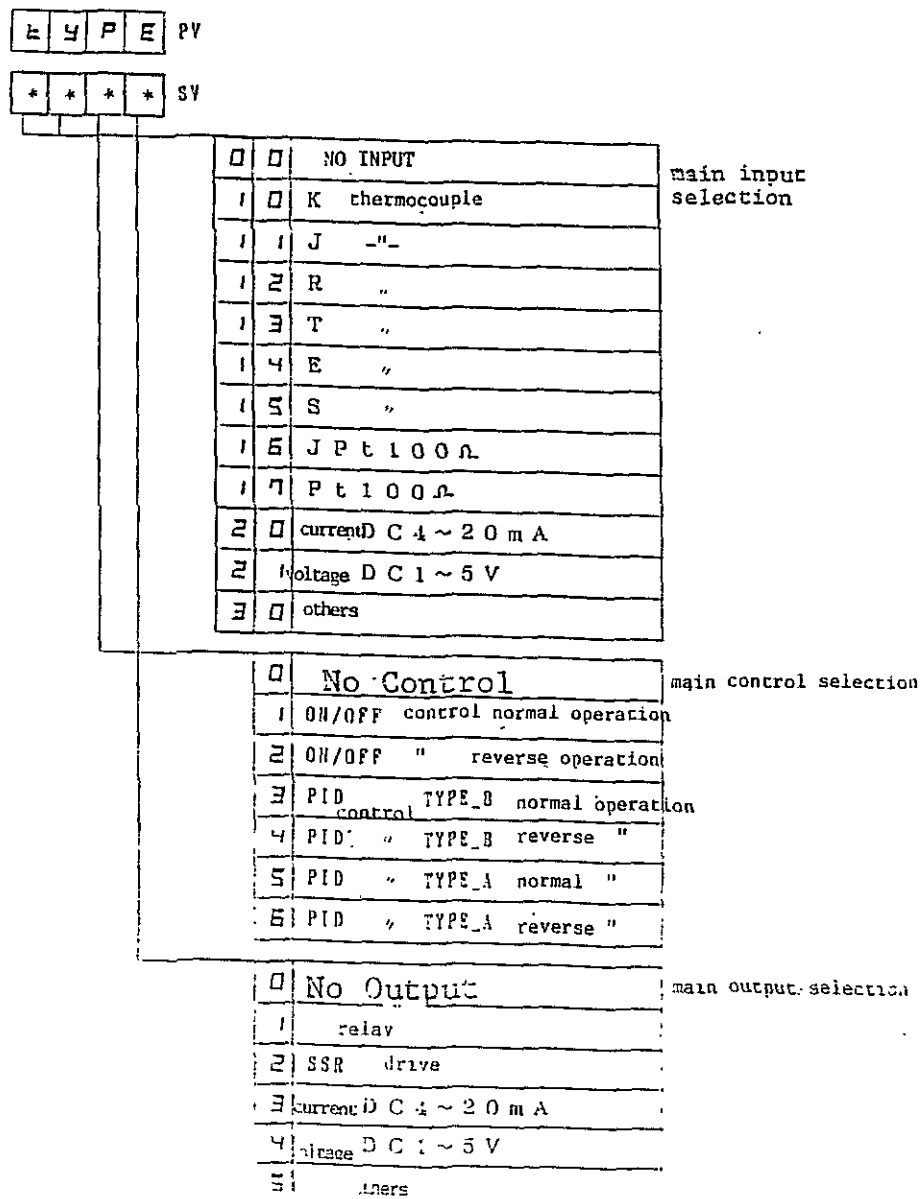

4.6 Parameter Definitions (Mode Menu)

Node **Mode Selection:** This parameter allows you to change the controller operation from automatic to manual or from local to remote. Remote operation is covered in analog voltage or current input option section. The right most pair of up/down keys will change the operation from auto to manual and the pair second from the right will change from local to remote.

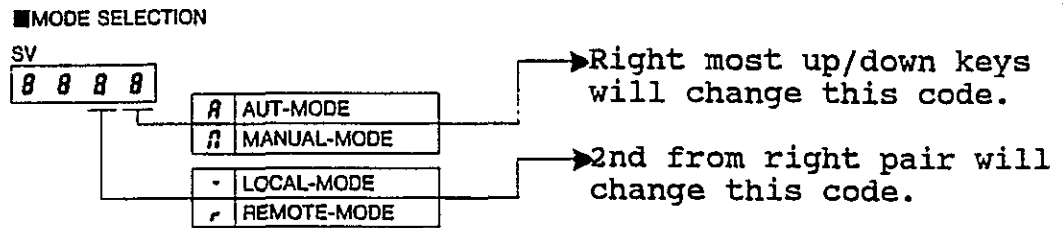

Manual Mode Operation

To make an auto to manual mode change, first, enter the mode menu and bring the **Node** parameter into the PV-display section. Using the right most pair of up/down keys change the **A** to **M**. The controller is now under manual operation. Pressing the function key will now display PV and MV (manipulated variable). The up/down keys are used to change the manipulated output. To view and change the sub-control manipulated variable press the left most down key.

- * The change between manual and auto mode is balanced and bumpless.
- * When the controller is operating in the manual mode, the normal PV-SV display will now indicate process variable and percentage of manipulated output respectively.

Manipulated Variable Display Illustration

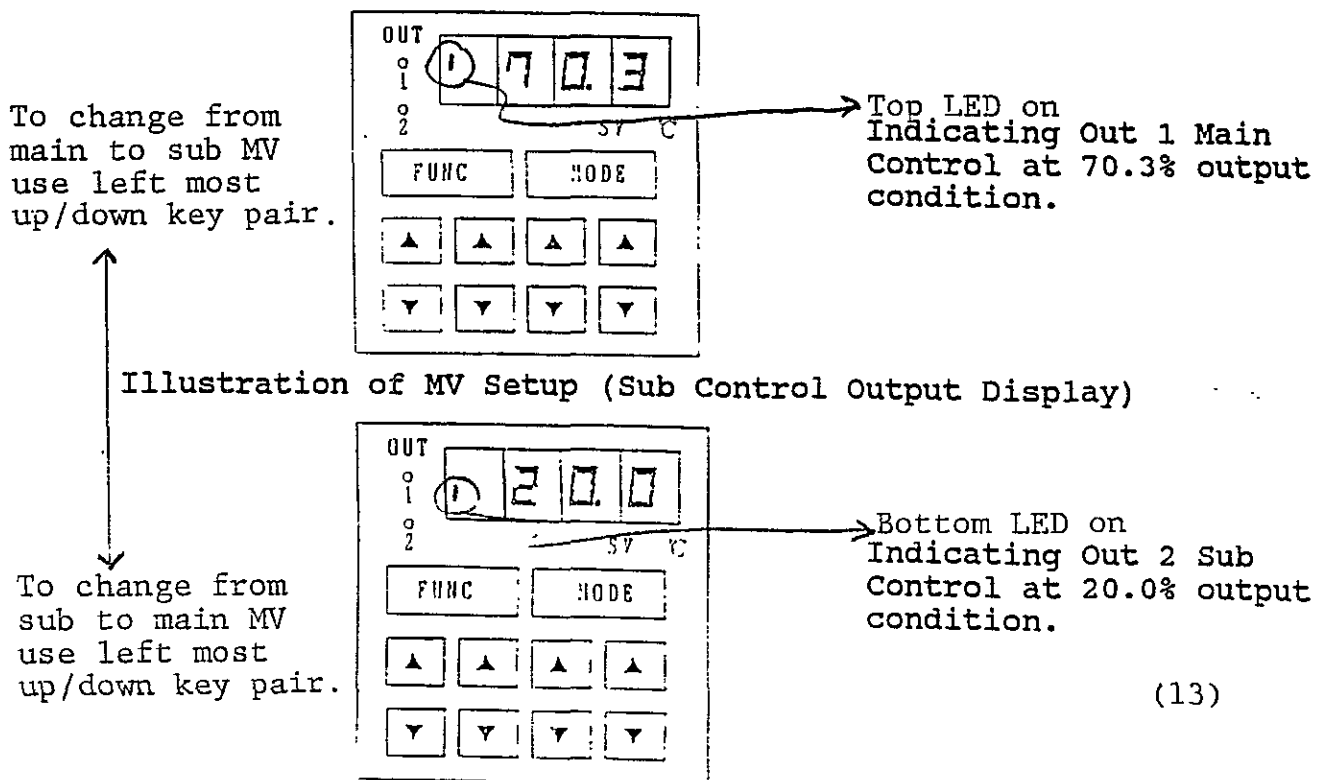

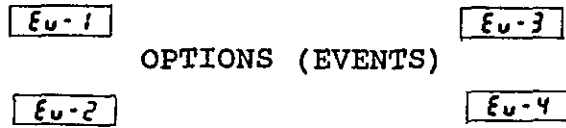

There are a total of four possible option (event) slots in each MC-125 controller. These four slots correspond to the event parameter settings (E_v-1, E_v-2, E_v-3, E_v-4) in the function menu. When any of these event parameters are brought into the PV-display section (see viewing parameters) the number in the SV-display section will indicate the option operation. The flowchart (Operation Manual) shows these parameters on the bottom left, just below the Main Control Input/Output Selection. The possible codes for these parameters are found under Setting Event on the right side of the flowchart. The possible event operations are:

Appendix Pg

Digital Input (Non voltage input).....	DI.1
Selectable Setpoints.....	DI.2
External Remote/Local Change.....	DI.4
External Auto/Manual Change.....	DI.4
External Autotuning ON/OFF.....	DI.5
Relay Output.....	RO.1
Sub-control Output.....	RO.2
Alarm Operation.....	RO.3
SSR Drive Sub-control Output.....	SSR.1
Current Transformer Input and Alarms.....	CTI.1
Analog Voltage/Current Input for Remote Setpoint...	AI.1
Analog Voltage/Current Output.....	AO.1
Sub-control Output.....	AO.2
Retransmission of:	
Process Variable (PV).....	AO.3
Setpoint Variable (SV).....	AO.3
Deviation (PV-SV).....	AO.4
Main Control Volume	AO.4
Sub-control Volume.....	AO.4
Remote SV.....	AO.4

Only those appendices corresponding to your option specification are included.

Selectable Setpoints with Digital Input

If you have ordered a digital input to be used for selecting setpoints, one or more of the option slot parameters (event settings), in the function menu, will contain the '1110' code. Selectable Setpoints allows you to save setpoint values in memory and switch them in and out of operation. **The setpoint values are entered and saved in the Mode menu under** R-SV SV-1 SV-2 SV-3 SV-4

Entering your Setpoints:

- * Press the MODE key until R-SV appears in the PV display section.
- * Use the up/down keys to enter the first setpoint value in the SV display section.
- * Press the MODE key again. SV-1 should appear in the PV display section.
- * Use the up/down keys to enter the second setpoint value in the SV display section. Continue until all setpoints are entered.

Example: One Digital Input in slot 2 is used to select between two different setpoints.

Step 1) Scroll through function menu and obtain EV-2 in the PV display section. The value in the SV section should be '1110' indicating selectable setpoints.

Step 2) Enter the Mode menu. Press the MODE key until R-SV appears in the PV display section.

Step 3) Use the up/down keys to enter the first setpoint.
For sake of example set R-SV = 100

Step 4) Press the MODE key again. SV-1 should appear in the SV display section.

Step 5) Use the up/down keys to enter the second setpoint.
For sake of example set SV-1 = 500

Step 6) Press the FUNC key.

The condition at screw terminals 11 and 12 will now determine the setpoint value as follows.

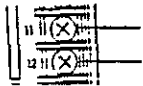
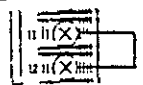
Terminals 11 and 12 Condition	EV2 LED Condition	Setpoint
 OPEN	OFF	R-SV = 100
 SHORT	ON	SV-1 = 500

Remote/Local Mode Change with Digital Input

If you have ordered a digital input to be used for Remote/Local mode change, one of the option slot parameters (event settings), in the function menu, will contain the '1210' code. An open circuit condition at the terminals corresponding to this digital input will put the controller into Local Mode operation. A short circuit condition at these terminals will light the respective 'EV' LED and put the controller into Remote Mode operation ('REM' LED will flash). The controller is now looking for an analog remote setpoint input. For more information on remote setpoint see Current/Voltage input.

Example: $\boxed{\text{Ev-3}}$ contains a '1210' corresponding to back screw terminals 5 and 6.

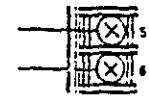
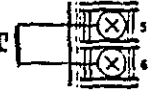
Terminals 5 and 6 Condition	EV3 LED Condition	Remote/Local Mode
OPEN 	OFF	Local
SHORT 	ON	Remote

Auto/Manual Mode Change with Digital Input

If you have ordered a digital input to be used for Auto/Manual mode change, one of the option slot parameters (event settings), in the function menu, will contain the '1310' code. An open circuit condition at the terminals corresponding to this digital input will put the controller into Auto Mode operation. A short circuit condition at these terminals will light the respective 'EV' LED and put the controller into Manual Mode operation ('MAN LED will flash). The normal PV-SV display is now a PV-MV display and the up/down keys can be used to change the percentage of manual manipulated output.

Example: $\boxed{\text{Ev-1}}$ contains a '1310' corresponding to back screw terminals 13 and 14.

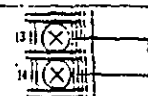
Terminal 13 and 14 Condition	EV1 LED Condition	Auto/Manual Mode
OPEN 	OFF	Auto
SHORT 	ON	Manual

RELAY OUTPUT APPENDIX

The Relay Output option (event) is used to for the following operations.

- Sub-control Output.....RO.2
- Alarms.....RO.3

This appendix is included only if you have specified one of these option operations. At least one of the event settings $\boxed{E} \boxed{U} \boxed{-} \boxed{1}$ - $\boxed{E} \boxed{U} \boxed{-} \boxed{4}$ will contain one of the following codes.

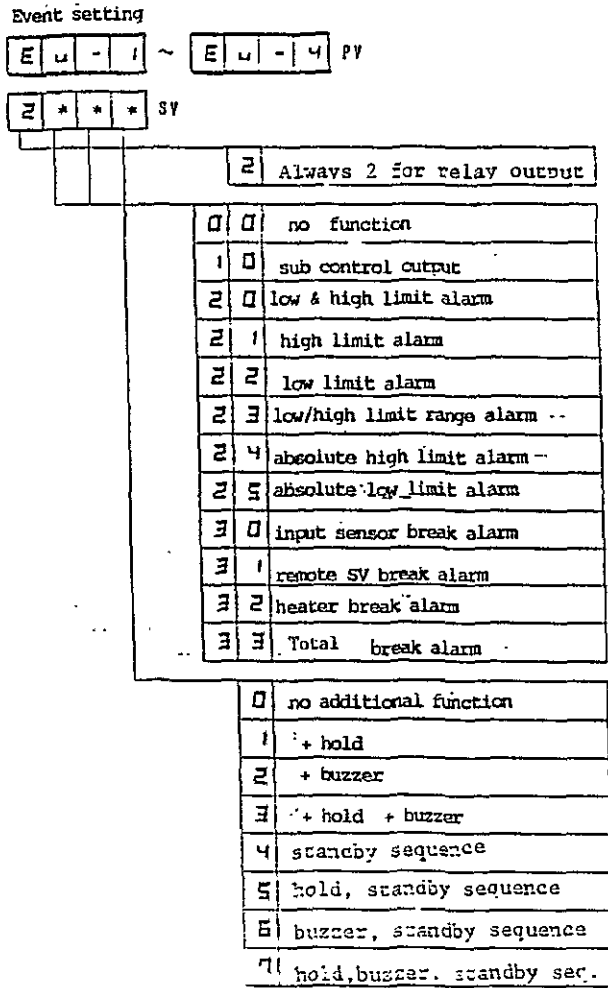

Relay Specifications

Relay is rated at 1 amp, 250 Vac.
 Relay terminals are isolated from all other terminals and CPU.

Alarms

The relay output can be used for a variety of alarm types. Any alarm option simply activates a relay for a specified condition. The option (event) parameter settings determines the alarm condition for your controller. See programming flow chart or page .

All alarm value settings are found in the Mode menu under and . All alarm sensitivity settings are found in the Function menu under and .

Alarm Types

High/Low Limit.....	RO.4
High Limit.....	RO.4
Low Limit.....	RO.4
High/Low Limit Range.....	RO.5
Absolute Value High Limit.....	RO.5
Absolute Value Low Limit.....	RO.5
Sensor Input Break	RO.6
Remote Setpoint (SV) Break.....	RO.6
Heater Break.....	CTI.3
Total Break.....	RO.7
Alarm Options.....	RO.7

High/Low Limit Range Deviation Alarm

Example: **Ev-3** is 2230

Option slot 3 (Event 3) is programmed for high/low limit range alarm. **RL3H** and **RL3L** are set in the mode menu and **RLC3** is set in the function menu.

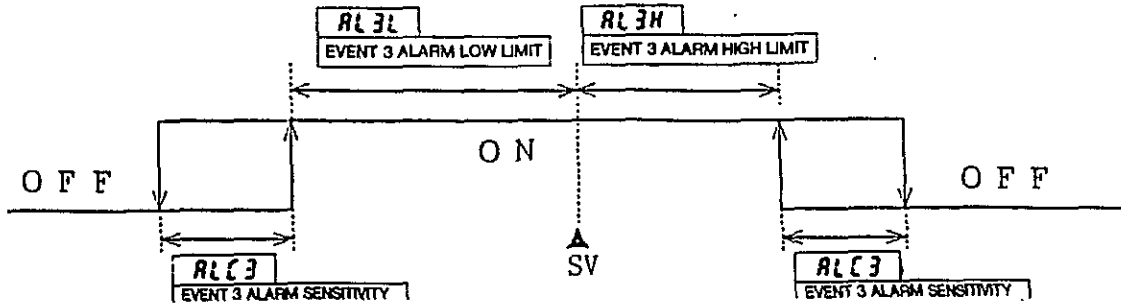

Absolute High Limit Alarm

Example: **Ev-4** is 2240

Option slot 4 (Event 4) is programmed for absolute high limit alarm. **RL4H** is set in mode menu and **RLC4** is set in function menu.

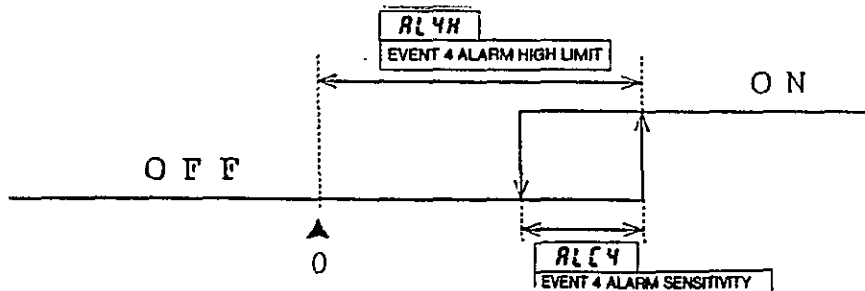

Absolute Low Limit Alarm

Example: **Ev-4** is 2250

Option slot 4 (Event 4) is programmed for absolute low limit alarm. **RL4L** is set in mode menu and **RLC4** is set in function menu.

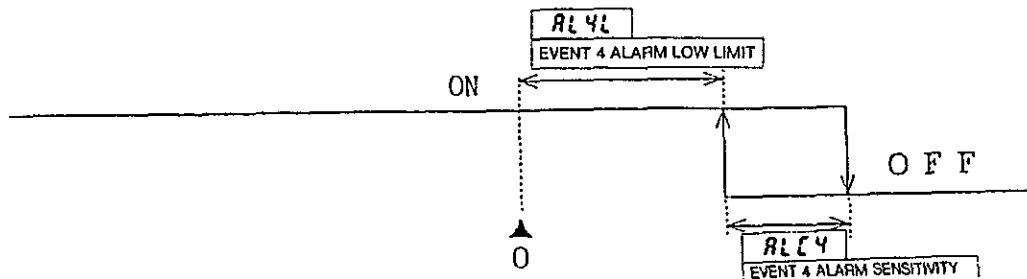

Total Break Alarm

Example: E 0 - 3 is 2330

Option 3 (Event 3) is programmed for total break alarm. The total break alarm combines the action of input break, remote setpoint break and heater break. When any of these break occur alarm condition is activated.

Alarm Options

Optional alarm functions are set with the last digit (right most digit) in the option (event) parameter setting. These include:

Hold: When alarm condition is activated it will remain on until power is shut off, even if alarm condition is removed.

Buzzer: Internal buzzer will ring during alarm condition. Any push button key will shut buzzer off.

Standby Sequence: The alarm condition must be removed then entered for alarm activation.

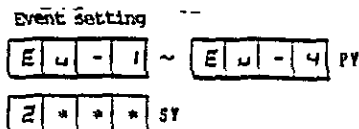

0	no additional function
1	+ hold
2	+ buzzer
3	+ hold + buzzer
4	standby sequence
5	hold, standby sequence
6	buzzer, standby sequence
7	hold, buzzer, standby sec.

CURRENT TRANSFORMER INPUT APPENDIX

The current transformer input is used to display the current (amps) drawn by your system, or to detect and alarm heater break cases. One option slot is needed for each current transformer input. The current, in amps, is displayed in the Mode menu under Ct-1 Ct-2 Ct-3 Ct-4.

The event parameter setting for current transformer input is '4100'. This programming code is located in the function menu.

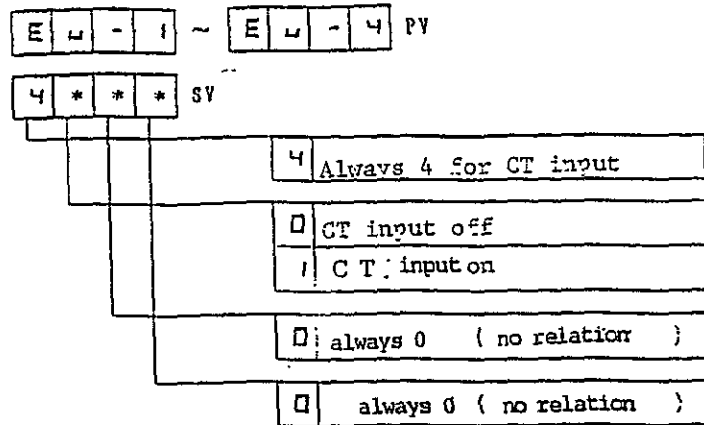

When using the current transformer input for heater break detection, one slot (input) is needed for single phase systems and two slots (inputs) are needed for three phase systems.

Single Phase Wiring:

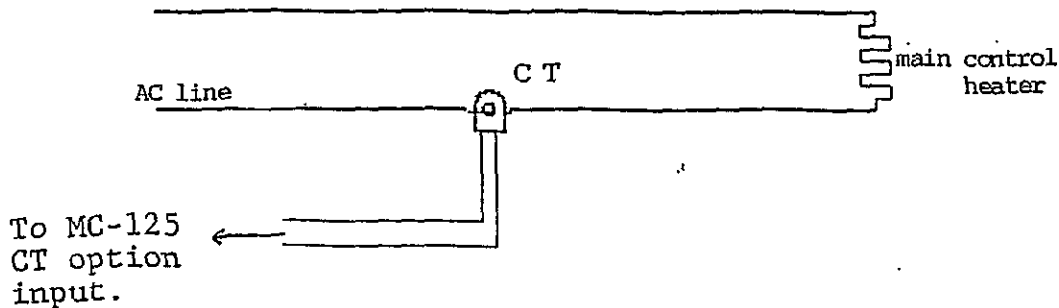

Three Phase Wiring:

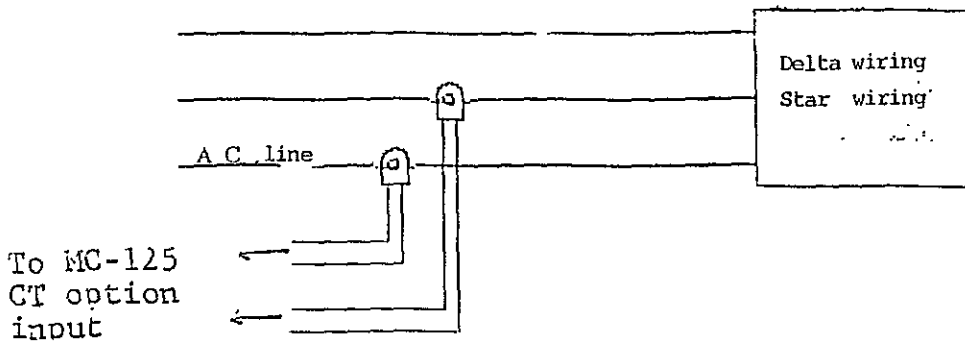

(CTI.1)

Heater Break Alarm

The option or event code for heater break alarm is 2320 which, for example, could be located in event slot 1 ($[Ev-1]$). All settings for heater break alarm option are located in the Mode menu. Current values (in amps) are viewed under $[It-1]$ and $[It-2]$. When either of these currents falls below the value set in $[HSEt]$ the heater break alarm condition is activated.

Single Phase: This option requires a current transformer input which populates an additional option slot. The output from the current transformer is attached to the current transformer input option slot terminals.

Determining your $[HSEt]$:

Measure $[It-1]$ with all heater banks on.

Measure $[It-1]$ with one heater bank off.

$$[HSEt] = \frac{[It-1] \text{ all on} + [It-1] \text{ one off}}{2}$$

This value is set in the Mode menu.

When the current drops below the $[HSEt]$ value the alarm condition is activated.

3 Phase: This option requires two current transformer inputs which populates two additional option slots.

Determining your $[HSEt]$:

CT1 Case $\left\{ \begin{array}{l} \text{Measure } [It-1] \text{ with all heater banks on.} \\ \text{Measure } [It-1] \text{ with one heater bank off.} \end{array} \right.$

CT2 Case $\left\{ \begin{array}{l} \text{Measure } [It-2] \text{ with all heater banks on.} \\ \text{Measure } [It-2] \text{ with one heater bank off.} \end{array} \right.$

$$[HSEt] \text{ (CT1 Case)} = \frac{[It-1] \text{ all on} + [It-1] \text{ one off}}{2}$$

$$[HSEt] \text{ (CT2 Case)} = \frac{[It-2] \text{ all on} + [It-2] \text{ one off}}{2}$$

If $[HSEt]$ (CT1 Case) is larger than $[HSEt]$ (CT2 Case) then;

Set $[HSEt] = [HSEt]$ (CT1 Case)

If $[HSEt]$ (CT2 Case) is larger than $[HSEt]$ (CT1 Case) then:e

Set $[HSEt] = [HSEt]$ (CT2 Case)

Turning On Remote Setpoint

$r5uL$, $r5uH$ and $r5u$ can be set before turning on remote setpoint. The Remote Setpoint Operation can be turned on and off by using front keys or digital input. See Digital Input Remote/Local Change for Remote/Local change using digital input.

Front Key On/Off Operation of Remote Setpoint

- * Press the MODE key until $ModE$ appears in the PV display section.
- * Use the up/down key pair second from the right to change from local to remote or from remote to local.

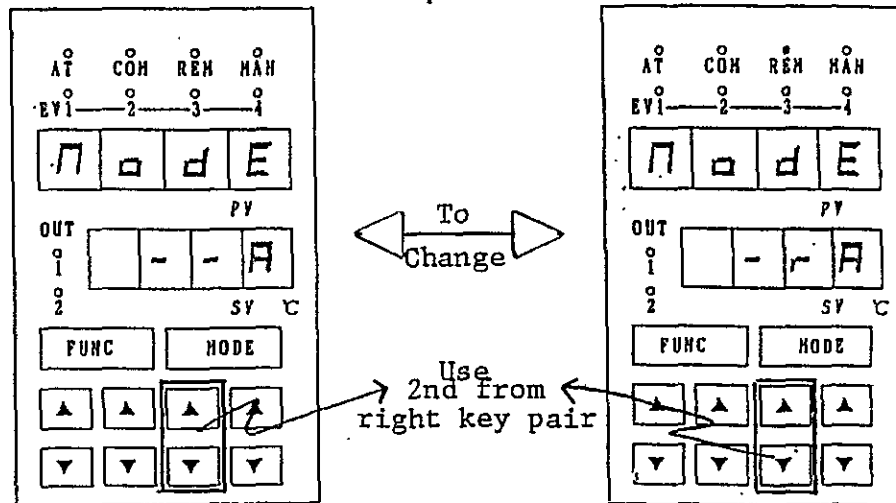

- * If you have programmed a digital input to change the Remote/Local operation, front key remote/local change will not work.

- * When the r appears in the SV display section the 'REM' LED will flash, indicating the use of the remote setpoint for control.

Example: Option slot 2 is programmed for remote setpoint with a 1-5V analog input. $E_{V-2} = 6100$

Diagram



Set $r5uL$ and $r5uH$ in the function menu. View the present remote setpoint value under $r5u$ in the function menu. The remote setpoint value can be adjusted before turning its operation on.

Sub-control Output

If you have ordered a analog sub-control output, event setting 3 ($\boxed{Ev-3}$) will contain either a 7100, for a 4-20mA signal, or a 8100, for a 1-5V signal. The sub-control output is automatically the reverse of the main control determined by \boxed{TYPE} . When main control is reverse acting, sub-control is direct and when main control is direct acting, sub-control is reverse. On/Off control is not available with analog outputs.

* Integral Time and Derivative Time are the same for main and sub-control.

$\boxed{P-2}$ **Sub-control Proportional Band:** Range where sub-control output is proportional to the amount of deviation from setpoint. Set as a percentage of the main control proportional band. Range is .1 to 999.9%.

\boxed{db} **Dead Band:** Dead band is the amount of separation or overlap between reverse acting control (heating) and direct acting control (cooling). A positive dead band setting will separate reverse and direct regions with a no control zone. A negative dead band setting will overlap reverse and direct regions creating a zone where both heating and cooling can occur.

Dead Band Illustration

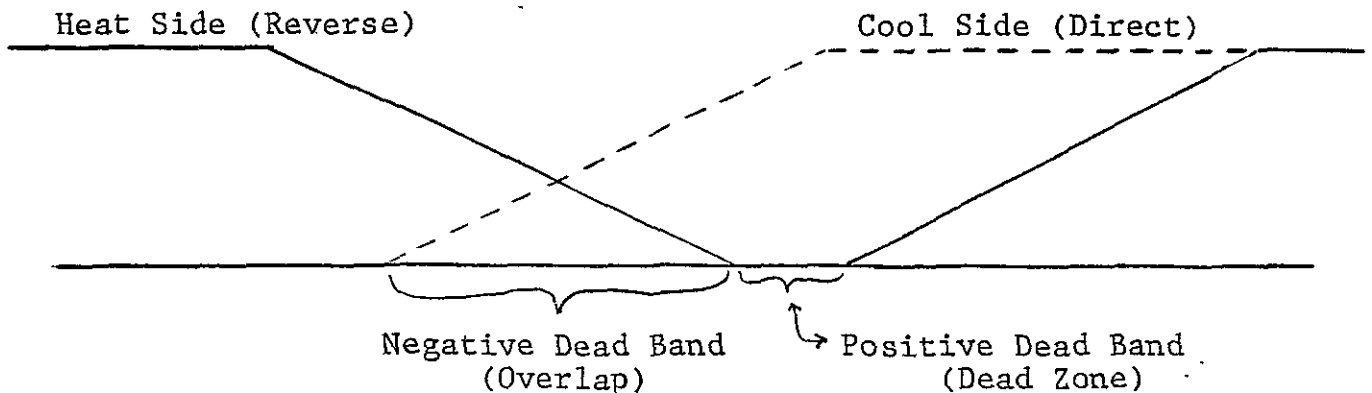

RETRANSMISSION

Deviation (PV-SV) Retransmission

A signal representing the difference between the process variable and the setpoint variable is available at the terminals corresponding to the option slot programmed for deviation retransmission.

Example: $\boxed{E_{v-3}} = '7400'$

The Analog Output Low and High Limit Settings, $\boxed{Ro3L}$ and $\boxed{Ro3H}$, are set in the function menu. A 4-20mA dc analog signal representing the difference between the process variable and the setpoint variable is produced at back screw terminals 5 and 6.

Main Control Volume Output Retransmission

A signal representing the percentage of main control output is available at the terminals corresponding to the option slot programmed for main control volume output retransmission.

Example: $\boxed{E_{v-4}} = '8500'$

The Analog Output Low and High Limit Settings, $\boxed{Ro4L}$ and $\boxed{Ro4H}$, are set in the function menu. A 1-5V dc analog signal representing the percentage of main control output is produced at back screw terminals 4 and 10.

Sub-Control Volume Output Retransmission

A signal representing the percentage of sub-control output is available at the terminals corresponding to the option slot programmed for sub-control volume output retransmission.

Example: $\boxed{E_{v-1}} = '7600'$

The Analog Output Low and High Limit Settings, $\boxed{Ro1L}$ and $\boxed{Ro1H}$, are set in the function menu. A 4-20mA dc analog signal representing the percentage of sub-control output is produced at back screw terminals 13 and 14.

Remote Setpoint Retransmission

A signal representing the remote setpoint is available at the terminals corresponding to the option slot programmed for remote setpoint retransmission.

Example: $\boxed{E_{v-2}} = '8700'$

The Analog Output Low and High Limit Settings, $\boxed{Ro2L}$ and $\boxed{Ro2H}$, are set in the function menu. A 1-5V dc analog signal representing the remote setpoint is produced at back screw terminals 11 and 12.

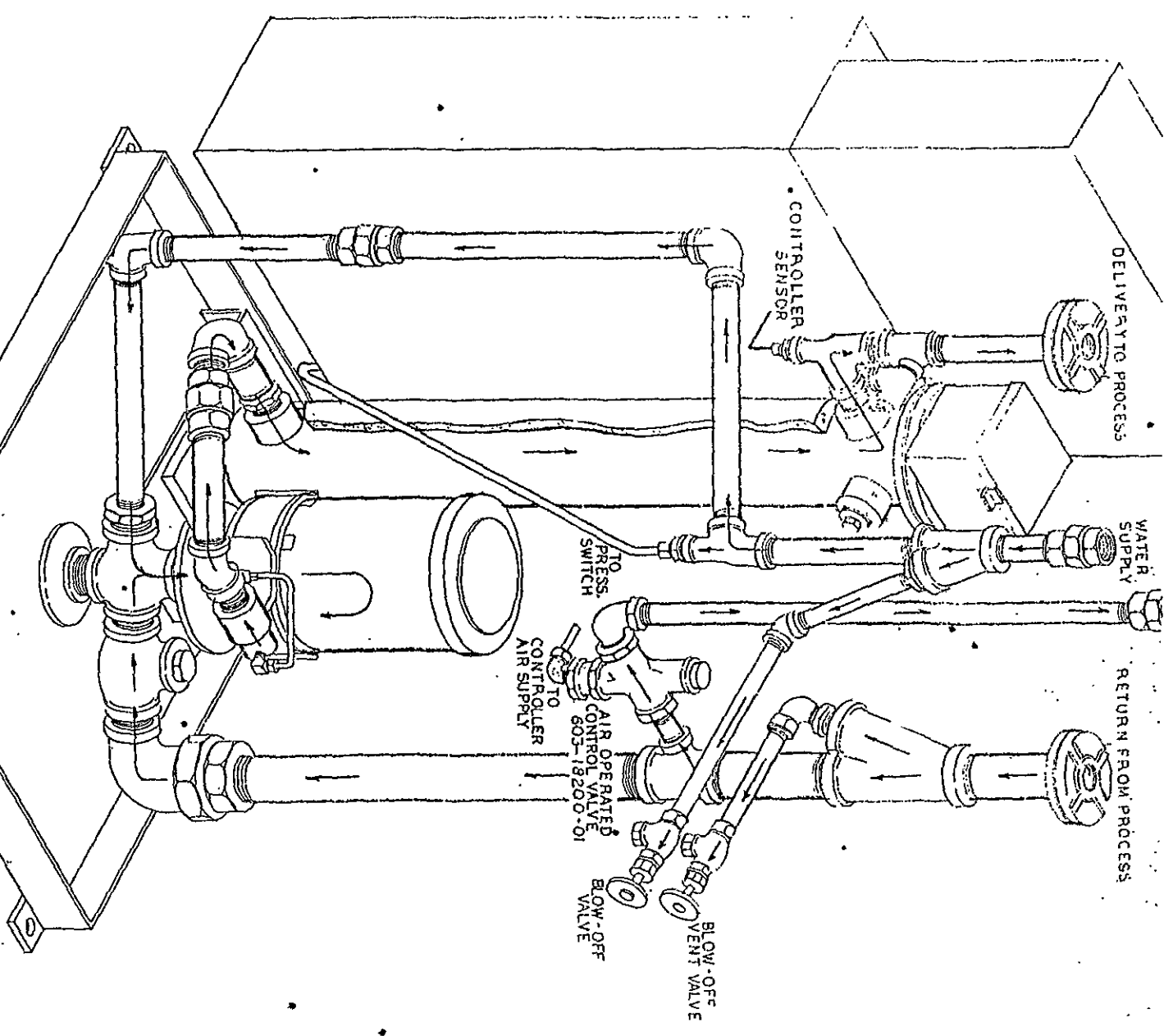

STERLING, INC. TITLE 6018-AF
 M. WAHNER, V.P. DRG. BY B.J.M. DATE 7/8/78 SCALE
 C-682-03936