

REPAIR PARTS MANUAL
MODEL NO. PR625Y22RP
(MFG. ID. NO. 96142005200)
Rotary Lawn Mower

For Parts and Service, contact our authorized distributor: call 1-800-849-1297
For Technical Assistance: call 1-800-829-5886

Poulan PRO

Poulan PRO

ROTARY LAWN MOWER -- MODEL NUMBER PR625Y22RP (MFG. ID. NO. 96142005200)

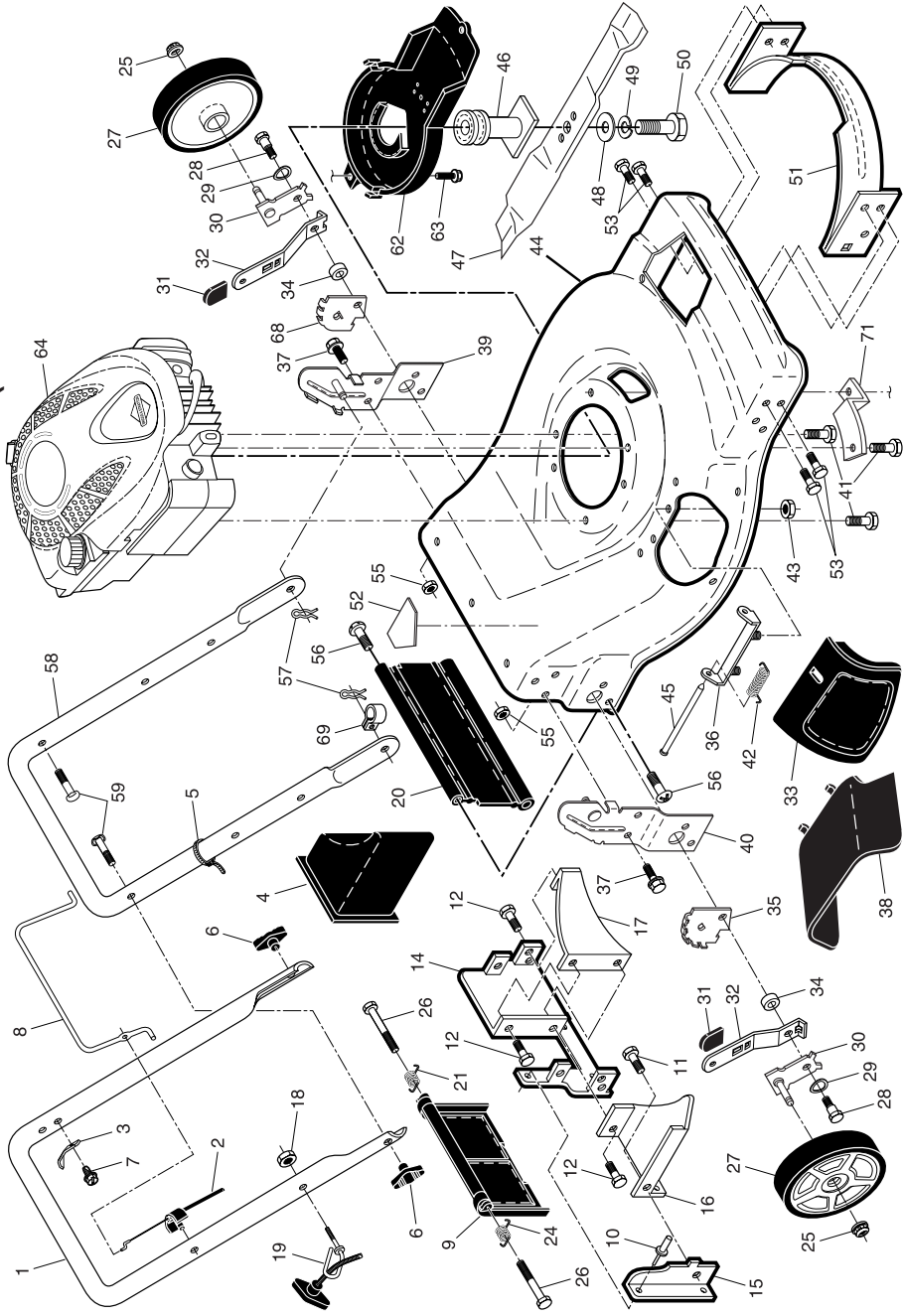

LIMITED WARRANTY

The Manufacturer warrants to the original consumer purchaser that this product as manufactured is free from defects in materials and workmanship. For a period of two (2) years from date of purchase by the original consumer purchaser, we will repair or replace, at our option, without charge for parts or labor incurred in replacing parts, any part which we find to be defective due to materials or workmanship. This Warranty is subject to the following limitations and exclusions.

1. This warranty does not apply to the engine, transaxle/transmission components, battery (except as noted below) or components parts thereof. Please refer to the applicable manufacturer's warranty on these items.
2. Transportation charges for the movement of any power equipment unit or attachment are the responsibility of the purchaser. Transportation charges for any parts submitted for replacement under this warranty must be paid by the purchaser unless such return is requested by the manufacturer.
3. Battery Warranty: On products equipped with a Battery, we will replace, without charge to you, any battery which we find to be defective in manufacture, during the first ninety (90) days of ownership. After ninety (90) days, we will exchange the Battery, charging you 1/12 of the price of a new Battery for each full month from the date of the original sale. Battery must be maintained in accordance with the instructions furnished.
4. The Warranty period for any products used for rental or commercial purposes is limited to 45 days from the date of original purchase.
5. This Warranty applies only to products which have been properly assembled, adjusted, operated, and maintained in accordance with the instructions furnished. This Warranty does not apply to any product which has been subjected to alteration, misuse, abuse, improper assembly or installation, delivery damage, or to normal wear of the product.
6. Exclusions: Excluded from this Warranty are belts, blades, blade adapters, normal wear, normal adjustments, standard hardware and normal maintenance.
7. In the event you have a claim under this Warranty, you must return the product to an authorized service dealer.

Should you have any unanswered questions concerning this Warranty, contact:

Poulan Pro
Customer Service Department
1030 Stevens Creek Road
Augusta, GA 30907 USA

In Canada contact:
Poulan Pro
Customer Service Department
5855 Terry Fox Way
Mississauga, Ontario L5V 3E4

giving the model number, serial number and date of purchase of your product and the name and address of the authorized dealer from whom it was purchased. THIS WARRANTY DOES NOT APPLY TO INCIDENTAL OR CONSEQUENTIAL DAMAGES AND ANY IMPLIED WARRANTIES ARE LIMITED TO THE SAME TIME PERIODS STATED HEREIN FOR OUR EXPRESSED WARRANTIES. Some areas do not allow the limitation of consequential damages or limitations of how long an implied Warranty may last, so the above limitations or exclusions may not apply to you. This Warranty gives you specific legal rights, and you may have other rights which vary from locale to locale. This is a limited Warranty within the meaning of that term as defined in the Magnuson-Moss Act of 1975.

ROTARY LAWN MOWER -- MODEL NUMBER PR625Y22RP (MFG. ID. NO. 96142005200)

KEY NO.	PART NO.	DESCRIPTION	KEY NO.	PART NO.	DESCRIPTION	KEY NO.	PART NO.	DESCRIPTION
1	194203X479	Upper Handle	28	174719	Bolt, Shoulder 3/8-16 x 1	50	851084	Screw, Machine, Hex Head 3/8-24 x 1-3/8 Grade 8
2	183567	Cable, Operator Presence	29	401630	Washer, Curved, Cylindrical	51	170031	Kit, Front Baffle (Includes Key Number 53)
3	850733X004	Bracket, Upstop	30	401179X004	Axle Arm Assembly	52	404763	Danger Decal
4	166649	Mulcher Plug	31	701037X421	Selector Knob	53	17600406	Screw, Serrated, TT 1/4-20
5	66426	Wire Tie	32	401621X004	Selector Spring	55	73930600	Nut, Hex 3/8-16
6	189713X428	Handle Knob	33	189917X428	Mulcher Door	56	88652	Hinge Screw 1/4-20 x 1-1/4
7	750634	Screw	34	401629	Spacer	57	51793	Hairpin Cotter
8	194199X421	Control Bar	35	407492X005	Wheel Adjusting Bracket, RH	58	151590X479	Lower Handle
9	401813X428	Rear Door Assembly	36	175735	Hinge Bracket Assembly	59	191574	Handle Bolt
10	128415	Pop Rivet	37	17000512	Screw, Sems, Thread Cutting 5/16-18 x 3/4	62	405843	Debris Shield
11	150050	Screw, Self-Tapping #10-24 x 5/8	38	402574X428	Discharge Deflector	63	192325	Screw, Debris Shield Engine, Briggs & Stratton, Model Number 122T02-1207-EA (For engine service and replacement parts, call Briggs & Stratton at 1-800-233-3723)
12	17060410	Screw, Hex Hex Head, Sems 1/4-20 x 1/2	39	195916X479	Handle Bracket Assembly, LH	64	- - -	Wheel Adjusting Bracket, LH
14	195622X479	Back Plate	40	195917X479	Handle Bracket Assembly, RH	68	407493X005	Wheel Adjusting Bracket, LH
15	410545	Side Baffle	41	150406	Screw, Hex Head, Threaded, Rolled 3/8-16 x 1-1/8	69	197991	Clip, Cable
16	176655X479	Discharge Baffle	42	193000	Spring, Torsion	71	188839X004	Mounting Bracket, Debris Shield
17	140661X479	Rear Baffle	43	738004000	Nut, Hex, Nylon	- -	404764	Warning Decal (not shown)
18	132004	Keys Locknut 1/4-20	44	419559	Kit, Mower Housing (Includes Key Numbers 14, 15 and 51)	- -	193733	Operator's Manual, English
19	194788	Rope Guide	45	175650	Rod, Hinge	- -	193736	Operator's Manual, French
20	413160	Rear Skirt	46	189179	Blade Adapter / Pulley	- -	424626	Repair Parts Manual
21	405421	Spring, Rear Door, LH	47	406713	Blade, 22"			
24	405423	Spring, Rear Door, RH	48	851074	Washer, Hardened			
25	409148	Nut, Hex, Flanged	49	850263	Washer, Helical			
26	184193	Bolt, Rear Door						
27	400248X421	Wheel & Tire Assembly, Rear						

IMPORTANT: Use only Original Equipment Manufacturer (O.E.M.) replacement parts. Failure to do so could be hazardous, damage your lawn mower and void your warranty.

NOTE: All component dimensions given in U.S. inches. 1 inch = 25.4 mm.

ROTARY LAWN MOWER -- MODEL NUMBER PR625Y22RP (MFG. ID. NO. 96142005200)

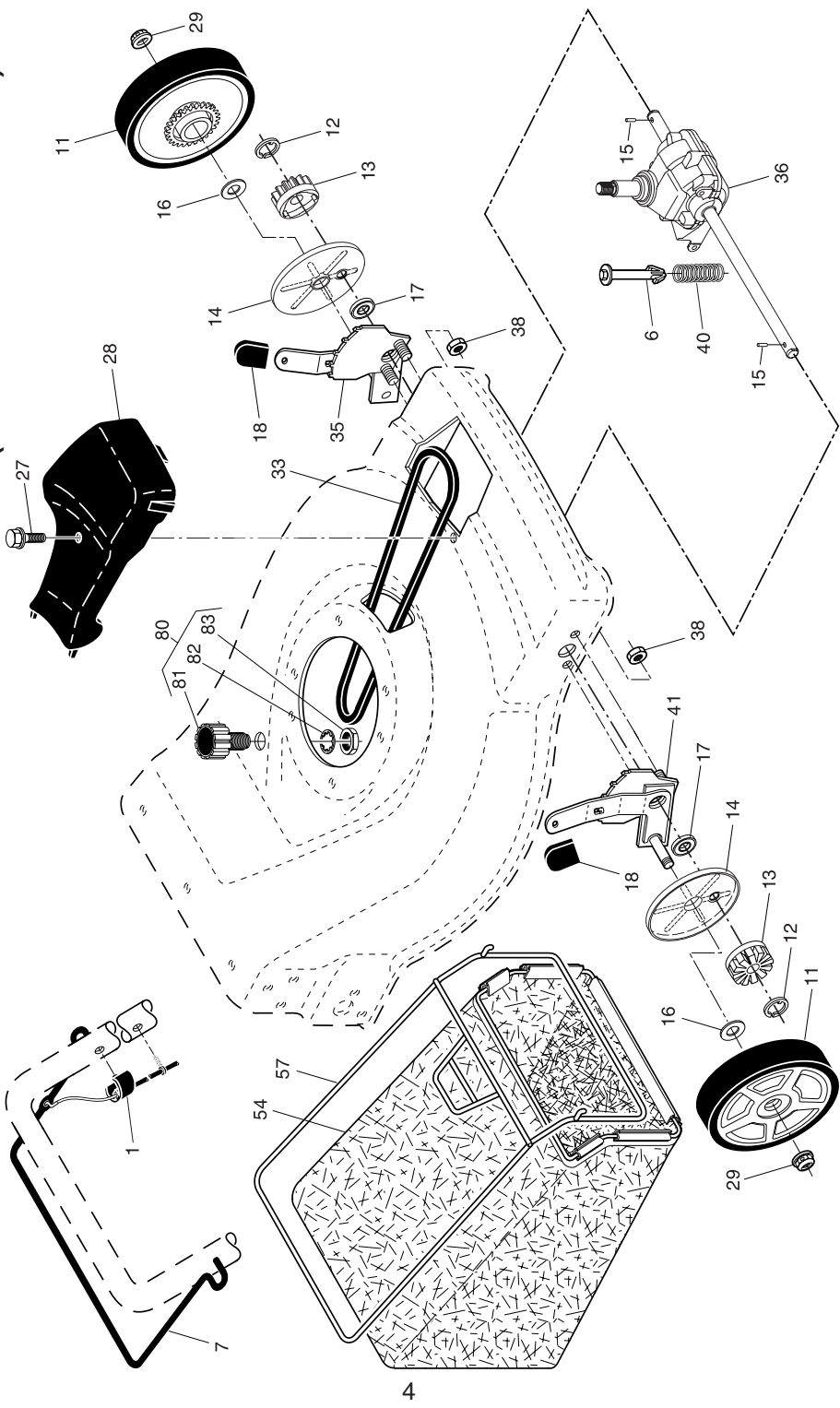

4

ROTARY LAWN MOWER -- MODEL NUMBER PR625Y22RP (MFG. ID. NO. 96142005200)

KEY NO.	PART NO.	DESCRIPTION	KEY NO.	PART NO.	DESCRIPTION
1	194653	Drive Control Assembly (Includes Cable)	33	146527	V-Belt
6	150495	Retainer, Spring	35	424201	Kit, Wheel Adjuster, LH (Includes Knob and Bearing)
7	194185X421	Bar, Drive Control	36	415226	Gear Case Assembly, Complete
11	193912X421	Wheel & Tire Assembly, Front	38	73800400	Locknut 1/4-20 Spring
12	12000058	E-Ring	40	137090	Kit, Wheel Adjuster, RH (Includes Knob and Bearing)
13	403849	Pinion	41	424200	Grassbag Assembly Frame, Grassbag
14	189403	Dust Cover	54	411062	Water Washout Assembly Fitting, Hose, Water Washout Washer, Lock, Internal Tooth Locknut, Hex, with O-Ring
15	404845	Pawl, Drive	57	411952	
16	67725	Washer, Flat 3/8	80	421114	
17	191039	Bearing, Wheel Adjuster	81	419735	
18	701037X421	Selector Knob	82	415585	
27	175262	Pan Head Tapping Screw #10-24 x 2-3/4	83	415586	
28	401271X428	Drive Cover			
29	409148	Locknut, Hex			

5

IMPORTANT: Use only Original Equipment Manufacturer (O.E.M.) replacement parts. Failure to do so could be hazardous, damage your lawn mower and void your warranty.

NOTE: All component dimensions given in U.S. inches. 1 inch = 25.4 mm.