

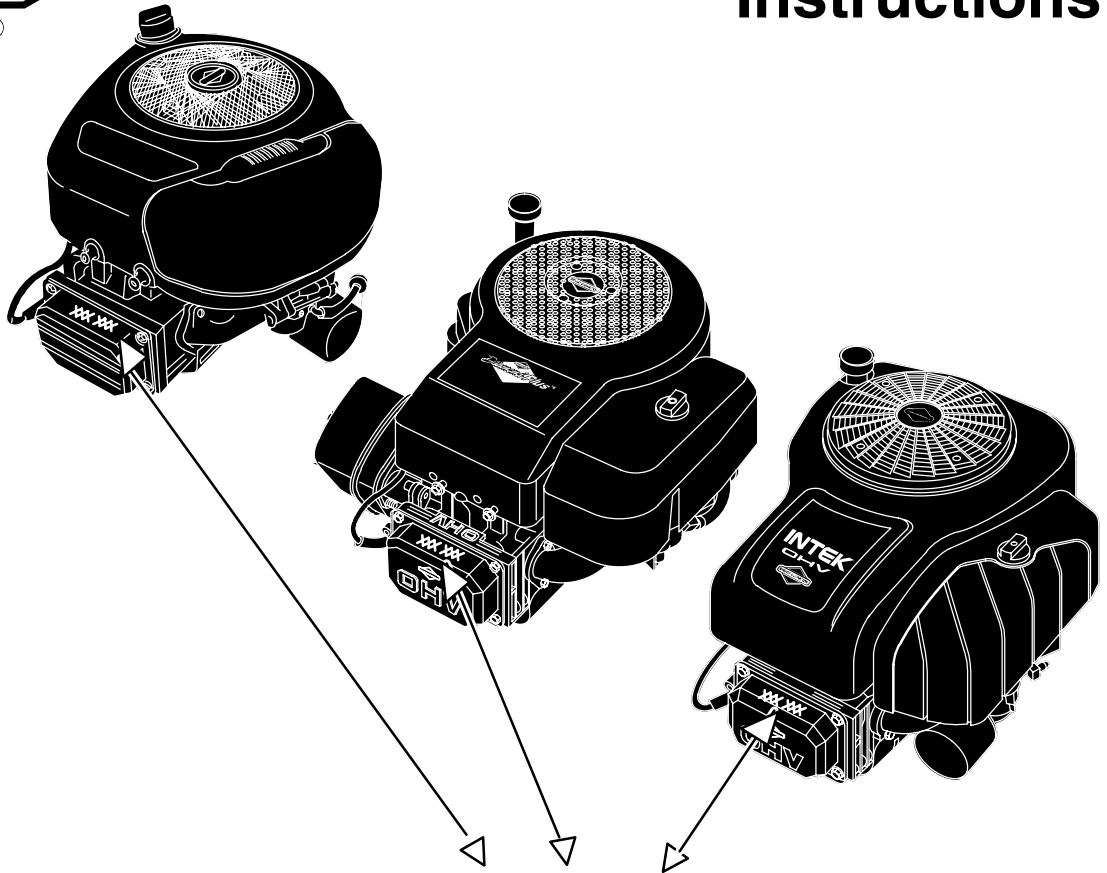

Operating & Maintenance Instructions

Model Series Covered in This Manual

210000
280000
310000



Model	Type	Code
<input type="text"/>	<input type="text"/>	<input type="text"/>
<input type="text"/>	<input type="text"/>	<input type="text"/>
<input type="text"/>	<input type="text"/>	<input type="text"/>
<input type="text"/>	<input type="text"/>	<input type="text"/>

Note: General Model Series numbers noted above are inclusive of the specific model number found on your engine. To get replacement parts or technical assistance in the future, write your engine Model, Type, Code and date of purchase here.

Month	Day	Year
<input type="text"/>	<input type="text"/>	<input type="text"/>
<input type="text"/>	<input type="text"/>	<input type="text"/>

TABLE OF CONTENTS	
Safety	3-5
Engine Information	6
Oil	7
Fuel and Starting Information	8
Starting and Stopping	9-10
Maintenance	11-13
Adjustments	14
Parts and Service & Storage	15-16
Warranty Information	17

WARNING

Briggs & Stratton does not approve or authorize the use of these engines on 3-wheel All Terrain Vehicles (ATVs), motor bikes, aircraft products or vehicles intended for use in competitive events. Use of these engines in such applications could result in property damage, serious injury (including paralysis), or even death.

Need assistance? Go to www.briggsandstratton.com for detailed information regarding Briggs & Stratton engines.
Or call, **1-800-233-3723**, (U.S.A. and Canada) to hear a menu of pre-recorded messages offering engine maintenance information.



The Power That Works For You.™

Look For Relevant Emissions Durability Period and Air Index Information On Your Engine Emissions Label

Engines that are certified to meet the California Air Resources Board (CARB) Tier 2 Emission Standards must display information regarding the Emissions Durability Period and the Air Index. Briggs & Stratton makes this information available to the consumer on our emission labels.

The **Emissions Durability Period** describes the number of hours of actual running time for which the engine is certified to be emissions compliant, assuming proper maintenance in accordance with the Operating & Maintenance Instructions. The following categories are used:

Moderate: Engine is certified to be emission compliant for 125 hours of actual engine running time.

Intermediate: Engine is certified to be emission compliant for 250 hours of actual engine running time.

Extended: Engine is certified to be emission compliant for 500 hours of actual engine running time.

For example, a typical walk-behind lawn mower is used 20 to 25 hours per year. Therefore, the **Emissions Durability Period** of an engine with an **intermediate** rating would equate to 10 to 12 years.

The **Air Index** is a calculated number describing the relative level of emissions for a specific engine family. The lower the **Air Index**, the cleaner the engine. This information is displayed in graphical form on the emissions label.



After July 1, 2000, Look For Emissions Compliance Period On Engine Emissions Compliance Label

After July 1, 2000 certain Briggs & Stratton engines will be certified to meet the United States Environmental Protection Agency (USEPA) Phase 2 emission standards. For Phase 2 certified engines, the Emissions Compliance Period referred to on the Emissions Compliance label indicates the number of operating hours for which the engine has been shown to meet Federal emission requirements. For engines less than 225 cc displacement, Category C = 125 hours, B = 250 hours and A = 500 hours. For engines of 225 cc or more, Category C = 250 hours, B = 500 hours and A = 1000 hours.

The displacement engines of Model Series 210000 is 344 cc, 280000 is 465 cc, 310000 engines is 501 cc.

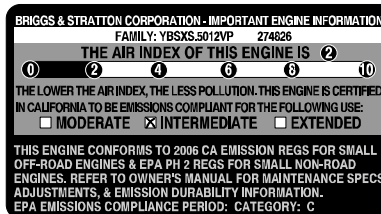
This is a generic representation of the emission label typically found on a certified engine.



BEFORE OPERATING ENGINE



- Read entire Operating & Maintenance Instructions AND the instructions for the equipment this engine powers.*
- Failure to follow instructions could result in serious injury or death.



THE OPERATING & MAINTENANCE INSTRUCTIONS CONTAIN SAFETY INFORMATION TO

- Make you aware of hazards associated with engines
- Inform you of the risk of injury associated with those hazards, and
- Tell you how to avoid or reduce the risk of injury.

The safety alert symbol () is used to identify safety information about hazards that can result in personal injury.







A signal word (DANGER, WARNING, or CAUTION) is used with the alert symbol to indicate the likelihood and the potential severity of injury. In addition, a hazard symbol may be used to represent the type of hazard.

- 
DANGER indicates a hazard which, if not avoided, **will result in death or serious injury.**
 - 
WARNING indicates a hazard which, if not avoided, **could result in death or serious injury.**
 - 
CAUTION indicates a hazard which, if not avoided, **might result in minor or moderate injury.**
- CAUTION**, when used **without** the alert symbol, indicates a situation that **could result in damage to the engine.**









WARNING

The engine exhaust from this product contains chemicals known to the State of California to cause cancer, birth defects, or other reproductive harm.

HAZARD SYMBOLS AND MEANINGS

		
Fire	Explosion	Moving Parts
		
Toxic Fumes	Hot Surface	Shock
		
	Kickback	

THE INTERNATIONAL SYMBOLS USED ON THE ENGINE OR IN THIS MANUAL INCLUDE:

		
Safety Alert	Read Owner's Manual	On Off
		
Oil	Stop	Fuel Shutoff
		
		
		Fuel

* Briggs & Stratton does not necessarily know what equipment this engine will power. For that reason, you should carefully read and understand the operating instructions for the equipment on which your engine is placed.



WARNING

Gasoline and its vapors are extremely flammable and explosive.



Fire or explosion can cause severe burns or death.

WHEN ADDING FUEL

- Turn engine OFF and let engine cool at least 2 minutes before removing gas cap.
- Fill fuel tank outdoors or in well-ventilated area.
- Do not overfill fuel tank. Fill tank to approximately 1-1/2 inches below top of neck to allow for fuel expansion.
- Keep gasoline away from sparks, open flames, pilot lights, heat, and other ignition sources.
- Check fuel lines, tank, cap, and fittings frequently for cracks or leaks. Replace if necessary.

WHEN STARTING ENGINE

- Make sure spark plug, muffler, fuel cap and air cleaner are in place.
- Do not crank engine with spark plug removed.
- If fuel spills, wait until it evaporates before starting engine.
- If engine floods, set choke to OPEN/RUN position, place throttle in FAST and crank until engine starts.

WHEN OPERATING EQUIPMENT

- Do not tip engine or equipment at angle which causes gasoline to spill.
- Do not choke carburetor to stop engine.

WHEN TRANSPORTING EQUIPMENT

- Transport with fuel tank EMPTY or with fuel shut-off valve OFF.

WHEN STORING GASOLINE OR EQUIPMENT WITH FUEL IN TANK

- Store away from furnaces, stoves, water heaters or other appliances that have pilot light or other ignition source because they can ignite gasoline vapors.



WARNING

Starting engine creates sparking.



Sparking can ignite nearby flammable gases.

Explosion and fire could result.

- If there is natural or LP gas leakage in area, do not start engine.
- Do not use pressurized starting fluids because vapors are flammable.



WARNING

Rapid retraction of starter cord (kickback) will pull hand and arm toward engine faster than you can let go.

Broken bones, fractures, bruises or sprains could result.

- When starting engine, pull cord slowly until resistance is felt, then pull rapidly.
- Remove all external equipment/engine loads before starting engine.
- Direct coupled equipment components such as, but not limited to, blades, impellers, pulleys, sprockets, etc., must be securely attached.



WARNING

Rotating parts can contact or entangle hands, feet, hair, clothing, or accessories.

Traumatic amputation or severe laceration can result.

- Operate equipment with guards in place.
- Keep hands and feet away from rotating parts.
- Tie up long hair and remove jewelry.
- Do not wear loose-fitting clothing, dangling drawstrings or items that could become caught.





SAFETY

 **WARNING**

 Engines give off carbon monoxide, an odorless, colorless, poison gas. Breathing carbon monoxide can cause nausea, fainting or death.

- Start and run engine outdoors.
- Do not start or run engine in enclosed area, even if doors or windows are open.

 **WARNING**

 Running engines produce heat. Engine parts, especially muffler, become extremely hot.

 Severe thermal burns can occur on contact.

 Combustible debris, such as leaves, grass, brush, etc. can catch fire.

- Allow muffler, engine cylinder and fins to cool before touching.
- Remove accumulated combustibles from muffler area and cylinder area.
- Install and maintain in working order a spark arrester before using equipment on forest-covered, grass-covered, brush-covered unimproved land. The state of California requires this (Section 4442 of the California Public Resources Code). Other states may have similar laws. Federal laws apply on federal land.

 **WARNING**

 Unintentional sparking can result in fire or electric shock.

 Unintentional start-up can result in entanglement, traumatic amputation, or laceration.

BEFORE PERFORMING ADJUSTMENTS OR REPAIRS

- Disconnect spark plug wire and keep it away from spark plug.
- Disconnect battery at negative terminal (only engines with electric start).

WHEN TESTING FOR SPARK

- Use approved spark plug tester.
- Do not check for spark with spark plug removed.



ENGINE INFORMATION

TECHNICAL INFORMATION

POWER RATINGS: The power ratings for an individual engine model are initially developed by starting with SAE (Society of Automotive Engineers) code J1940 (Small Engine Power & Torque Rating Procedure) (Revision 2002-05). Given both the wide array of products on which our engines are placed, and the variety of environmental issues applicable to operating the equipment, it may be that the engine you have purchased will not develop the rated horsepower when used in a piece of power equipment (actual "on-site" power). This difference is due to a variety of factors including, but not limited to, the following:

differences in altitude, temperature, barometric pressure, humidity, fuel, engine lubrication, maximum governed engine speed, individual engine to engine variability, design of the particular piece of power equipment, the manner in which the engine is operated, engine run-in to reduce friction and clean out of combustion chambers, adjustments to the valves and carburetor, and other factors. The power ratings may also be adjusted based on comparisons to other similar engines utilized in similar applications, and will therefore not necessarily match the values derived using the foregoing codes.

ENGINE INFORMATION

BRIGGS & STRATTON

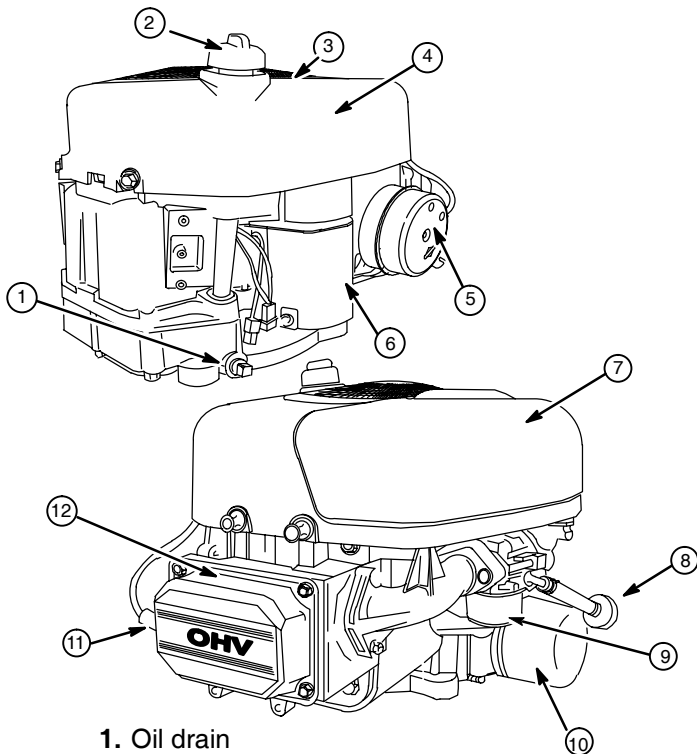

1. Oil drain
2. Oil fill/Dipstick
3. Rotating screen
4. Blower housing
5. Muffler/(Muffler guard, if equipped)/
(Spark arrester, if equipped)
6. 12 V electric starter

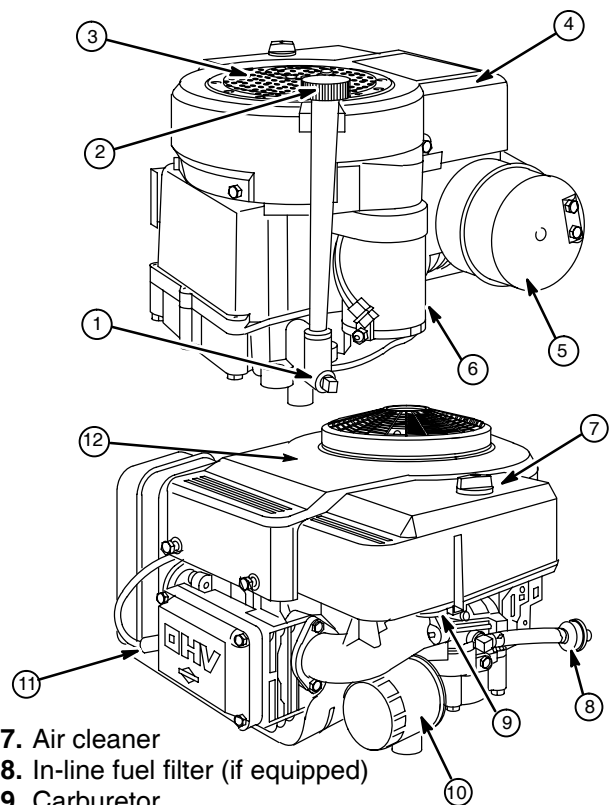

7. Air cleaner
8. In-line fuel filter (if equipped)
9. Carburetor
10. Oil filter (if equipped)
11. Spark plug wire
12. Engine Model Type Code
xxxxx xxxx xx xxxxxxxx

GENERAL INFORMATION

ENGINE MODEL

This is a single cylinder, overhead valve (OHV), air-cooled engine. It is a low emissions engine.

In the state of California, OHV Model Series 210000, 280000 and 310000 engines are certified by the California Air Resources Board to meet emissions standards for 250 hours. Such certification does not grant the purchaser, owner or operator of this engine any additional warranties with respect to the performance or operational life of this engine. This engine is warranted solely according to the product and emissions warranties stated elsewhere in this manual.

TUNE-UP SPECIFICATIONS

Armature air gap ... 0.010 – 0.014 in. (0.25 – 0.36 mm)
 Spark plug gap 0.030 in. (0.76 mm)
 Valve clearance with valve springs installed and piston 1/4 in. (6 mm) past top dead center (check when engine is cold). See Repair Manual P/N 272147.
 Intake 0.003 – 0.005 in. (0.08 – 0.13 mm)
 Exhaust 0.005 – 0.007 in. (0.13 – 0.18 mm)

MODEL SERIES 210000

Bore 3-7/16 in. (87.31 mm)
 Stroke 2-17/64 in. (77.78 mm)
 Displacement 21.00 cu. in. (344.1 cc)

MODEL SERIES 280000

Bore 3-7/16 in. (87.31 mm)
 Stroke 3-1/16 in. (77.78 mm)
 Displacement 28.42 cu. in. (465.7 cc)

MODEL SERIES 310000

Bore 3-9/16 in. (90.60 mm)
 Stroke 3-1/16 in. (77.78 mm)
 Displacement 30.59 cu. in. (501.2 cc)

Note: For practical operation, the horsepower loading should not exceed 85% of rated horsepower. Engine power will decrease 3-1/2% for each 1,000 feet (300 meters) above sea level and 1% for each 10° F (5.6° C) above 77° F (25° C). Engine will operate satisfactorily at an angle up to 15°.



CAUTION: This engine is shipped from Briggs & Stratton **without oil**. Check oil level before starting engine. If you start the engine without oil, the engine will be damaged beyond repair and will not be covered under warranty.

OIL CAPACITY

Engine without oil filter holds approximately 1-1/2 quarts (48 ounces; 1.4 liters).

TYPE OF OIL TO USE

- Use a high quality detergent oil classified “For Service SF, SG, SH, SJ” or higher, such as Briggs & Stratton 30W, Part Number 100005 (20 oz) or 100028 (48 oz).
- Do not use special additives.
- Choose a viscosity according to the table opposite.

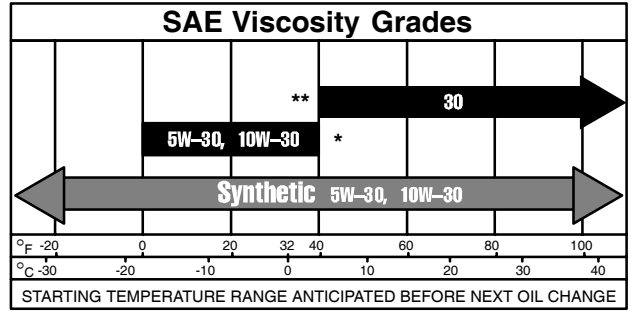

Note: Synthetic oil meeting ILSAC GF-2, API certification mark and API service symbol (shown at left) with “SJ/CF ENERGY CONSERVING” or higher, is an acceptable oil at all temperatures. **Use of synthetic oil does not alter required oil change intervals.**

* **CAUTION:** Air cooled engines run hotter than automotive engines. The use of non-synthetic multi-viscosity oils (5W-30, 10W-30, etc.) in temperatures above 40° F (4° C) will result in higher than normal oil consumption. When using a multi-viscosity oil, check oil level more frequently.

** **CAUTION:** SAE 30 oil, if used below 40° F (4° C), will result in hard starting and possible engine bore damage due to inadequate lubrication.

CHECKING AND ADDING OIL

- Check oil level *before* starting the engine.
- Check level daily, or after every eight (8) hours.
- Keep oil level at FULL.
- Do not overfill.

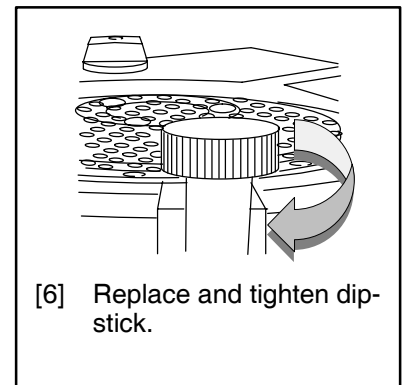
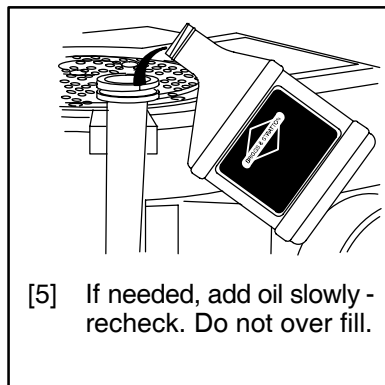
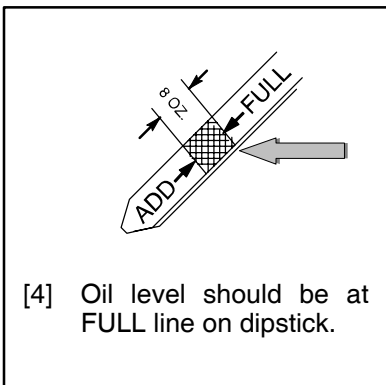
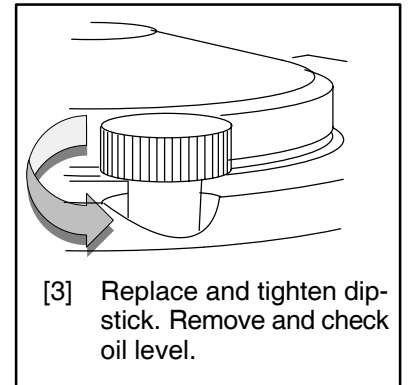
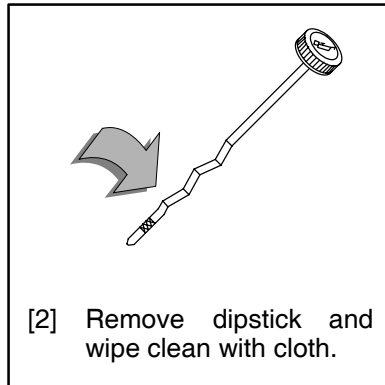
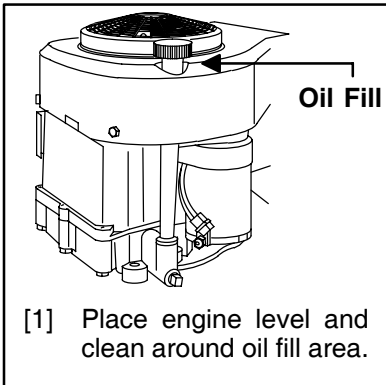

FUEL



BRIGGS & STRATTON

TYPE OF FUEL TO USE

- Use clean, fresh, regular unleaded gasoline with a minimum of 85 octane. Fresh fuel prevents gum from forming in the fuel system or on essential carburetor parts. Purchase fuel in quantity that can be used within 30 days.
- Do not use gasoline which contains Methanol.
- Do not mix oil with gasoline.
- For engine protection use Briggs & Stratton Gasoline Additive available from your Authorized Briggs & Stratton Dealer (P/N 5041 or single use pouch).

- This engine is certified to operate on gasoline. Exhaust Emission Control System: EM (Engine Modifications).

CAUTION: Some fuels, called oxygenated or reformulated gasoline, are gasoline blended with alcohols or ethers. Excessive amounts of these blends can damage the fuel system or cause performance problems. If any undesirable operating symptoms occur, use gasoline with a lower percentage of alcohol or ether.

ADDING FUEL

WARNING



- Turn engine OFF and let engine cool at least 2 minutes before removing gas cap.
- Fill fuel tank outdoors or in well-ventilated area.
- Keep gasoline away from sparks, open flames, pilot lights, heat, and other ignition sources.
- If fuel spills, wait until it evaporates before starting engine.

- [1] Remove cap. Fill tank to approximately 1-1/2 inches below top of neck to allow for fuel expansion. Be careful not to overfill. Briggs & Stratton **Smart-fill® fuel can** fills to the correct level and automatically shuts off, reducing spills and emissions.
- [2] Replace cap before starting.

STARTING

BRIGGS & STRATTON

WARNING



- Do not use pressurized starting fluids.
- Vapors are flammable.

OIL PRESSURE SWITCH

If engine is equipped with an oil pressure switch, the switch will either activate a warning light or stop the engine when the engine runs low on oil. (Read the operating instructions supplied by the equipment manufacturer to determine which way your engine is equipped because the equipment manufacturer supplies the oil pressure gauge.)

See **OIL PRESSURE** on page 12 for oil filling instructions.

STARTING AND OPERATING TIPS

- ◆ Store and fuel equipment in level position.
- ◆ Use fresh fuel. (See Fuel.)
- ◆ Use correct type of oil for expected starting temperature. (See Oil.)
- ◆ Remove external equipment/engine loads. (See equipment operating instructions.)
- ◆ Start lawn mower on hard surface or over previously cut grass.
- ◆ Periodically remove grass buildup under mower deck. (See Maintenance.)
- ◆ After engine has started, let it warm up several seconds to several minutes, depending on outside temperature.
- ◆ For maximum performance and life, operate engine with choke in RUN and throttle in FAST.



STARTING AND STOPPING

REWIND (MANUAL) STARTER (auxiliary)

TO START ENGINE

[1] Check oil level (see p. 7).
[2] Open fuel shut-off valve (if equipped) 1/4 turn.

Choke **Throttle**

[3] If choke and throttle controls are separate, move choke control to CHOKE. Move throttle to FAST.

Choke/throttle control

[4] If choke and throttle are on the same control, move control to CHOKE or START

[5] Insert key and turn to RUN.

WARNING

[6] Grasp rope handle. Pull slowly until resistance is felt, then pull rapidly to start engine and avoid kickback.

[7] Let engine warm up. **If choke equipped:** Slowly adjust toward RUN position. Wait until engine runs smoothly before each choke adjustment.

TO STOP ENGINE

CAUTION: Do not stop engine by moving choke control to CHOKE. Backfire, fire or engine damage could occur.

[1] With throttle in FAST, turn key to OFF. Remove key and store out of reach of children.

[2] Close fuel shut-off valve (if equipped).

STARTING AND STOPPING

BRIGGS & STRATTON

ELECTRIC (KEY) STARTER (if equipped)

TO START ENGINE

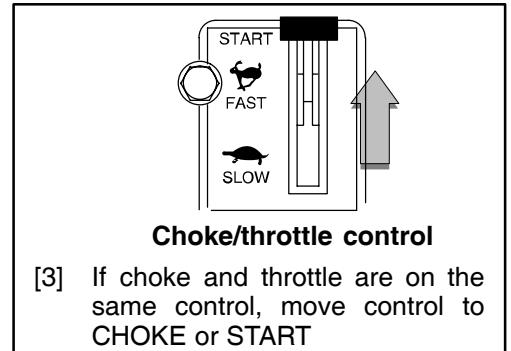
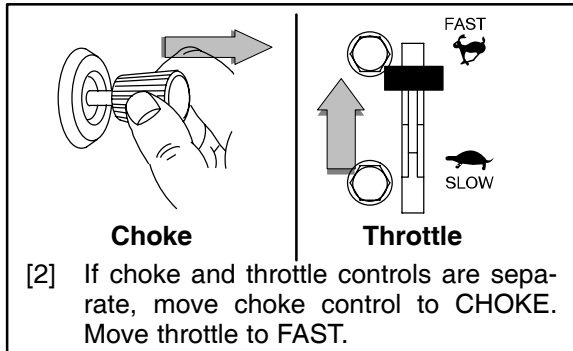
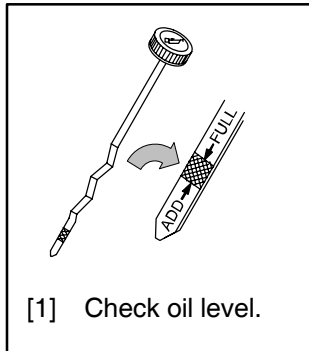

CAUTION:
To prolong starter life, use short starting cycles (5 seconds maximum, then wait one minute). Follow equipment manufacturer's recommendations for charging battery.

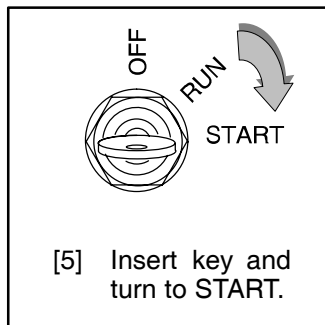
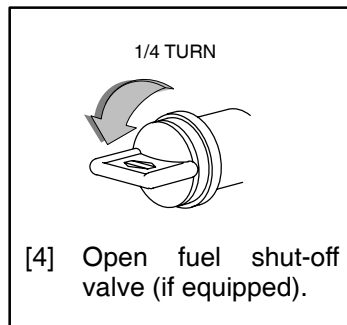

[6] Let engine warm up. **If choke equipped:** Slowly adjust toward RUN position. Wait until engine runs smoothly before each choke adjustment.

TO STOP ENGINE

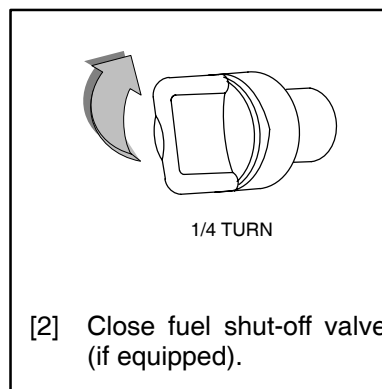
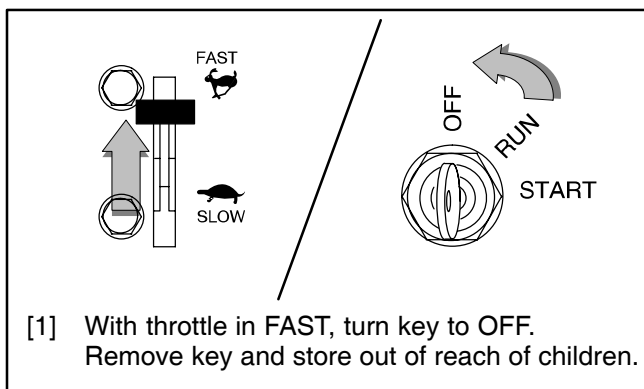



MAINTENANCE

Regular maintenance will improve the performance and extend the life of the engine. See any Authorized Briggs & Stratton Dealer for service. **Use only genuine Briggs & Stratton parts. Other parts may not perform as well, may damage the engine, and may result in injury.** In addition, use of other parts may void your warranty.

Task <i>Perform task at hourly or calendar interval, whichever comes first.</i>	Every 8 Hours or Daily	25 Hours or Every Season	50 Hours or Every Season	100 Hours or Every Season	200 Hours or Every Season	Yearly
Check Oil Level	✓					
Change Oil			✓*			
Change oil filter (if equipped)				✓*		
Service air cleaner pre-cleaner (if equipped)		✓**				
Replace air cleaner cartridge (if not equipped with pre-cleaner)		✓**				
Replace air cleaner cartridge (if equipped with pre-cleaner)				✓**		
Clean Extended Life Series™ air cleaner cartridge			✓**			
Replace Extended Life Series™ air cleaner cartridge					✓**	
Inspect spark arrester (if equipped)			✓			
Replace spark plug				✓		
Replace in-line fuel filter (if equipped)				✓		
Clean cooling system				✓**		
Check valve clearance						✓

* **Change oil after first 5 to 8 hours of use**, then every 50 hours or every season. Change oil every 25 hours when operating the engine under heavy load or in high temperatures.

** Clean more often under dusty conditions or when airborne debris is present. Replace air cleaner parts, if very dirty.

EMISSION CONTROL

Maintenance, replacement or repair of the emission control devices and systems may be performed by any nonroad engine repair establishment or individual. However, to obtain no charge repairs under the terms and provisions of the Briggs & Stratton warranty statement, any service or emission control part repair or replacement must be performed by a factory authorized dealer.

CHANGING OIL

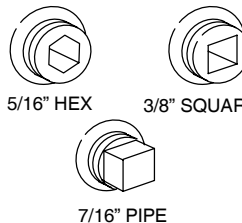

5/16" HEX 3/8" SQUARE



7/16" PIPE

Typical drain plugs

TO REMOVE

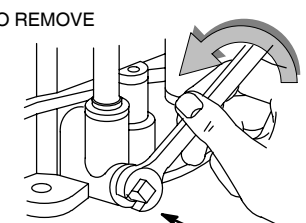

OIL DRAIN PLUG

WARNING



- [1] Place engine level.
- [2] Disconnect spark plug wire and keep away from spark plug. Disconnect battery (if equipped with electric starter) at negative terminal.
- [3] With engine OFF but still warm remove oil drain plug and drain oil into appropriate receptacle.
- [4] Reinstall drain plug. Remove dipstick.
- [5] Fill to FULL mark on dipstick with new oil.
Do not overfill.

Note: Engine without oil filter holds approximately 1-1/2 quarts (48 ounces; 1.4 liters). Engine equipped with filter holds approximately 1-3/4 quarts (56 ounces; 1.7 liters).

- [6] Replace dipstick.

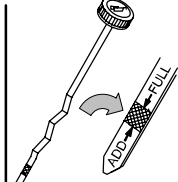
CAUTION: Used oil is a hazardous waste product. Dispose of used oil properly. Do not discard with household waste. Check with your local authorities, service center, or dealer for safe disposal/recycling facilities.

AIR CLEANER

CAUTION: Do not use pressurized air or solvents to clean cartridge. Pressurized air can damage cartridge; solvents will dissolve cartridge.

FLAT AIR CLEANER REMOVAL/ INSTALLATION

- [1] Pull up on air cleaner cover handle, and rotate toward engine.
- [2] Remove air cleaner cover.
- [3] Carefully lift air cleaner cartridge and pre-cleaner, if equipped, from blower housing.

Note: To clean pre-cleaner, wash in soapy water. Squeeze dry in a clean cloth. **DO NOT OIL.**

- [4] Clean base of air cleaner cartridge area carefully to prevent debris from entering engine.
- [5] Place air cleaner pre-cleaner, if equipped, and cartridge into blower housing. Cartridge must fit securely in base.
- [6] Align tabs on cover with slots of blower housing and replace cover.
- [7] Hook handle and close cover.

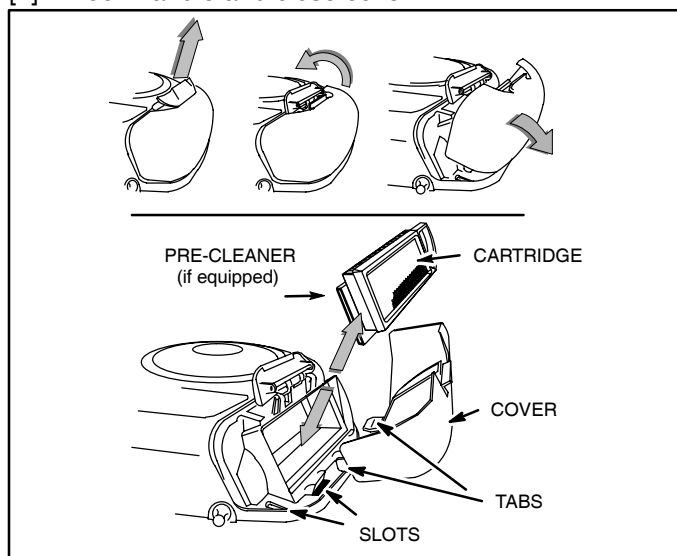

EXTENDED LIFE SERIES™ CARTRIDGE ONLY

This filter, IF STAMPED 'WASH-ABLE', can be washed with warm water and mild soap.

IMPORTANT: Rinse in tap water with **SCREEN** side up allowing dirt and debris to filter out.

Leave filter to dry overnight before reinstalling.

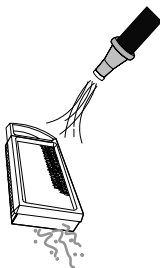

OVAL AIR CLEANER REMOVAL / INSTALLATION

- [1] Remove cover knob and cover.
- [2] Remove cartridge knob.
- [3] Carefully lift air cleaner assembly (pre-cleaner, if equipped, and cartridge) from base over stud.

Note: To clean pre-cleaner (if equipped), separate it from cartridge and wash soapy water. Squeeze dry in a clean cloth. Saturate in engine oil. Squeeze in clean, absorbent cloth to remove all EXCESS oil.

- [4] Clean base carefully to prevent debris from entering carburetor.
- [5] Reassemble pre-cleaner on cartridge and place assembly over stud. Air cleaner must fit securely in base.
- [6] Tighten cartridge knob securely.
- [7] Replace cover and tighten cover knob securely.

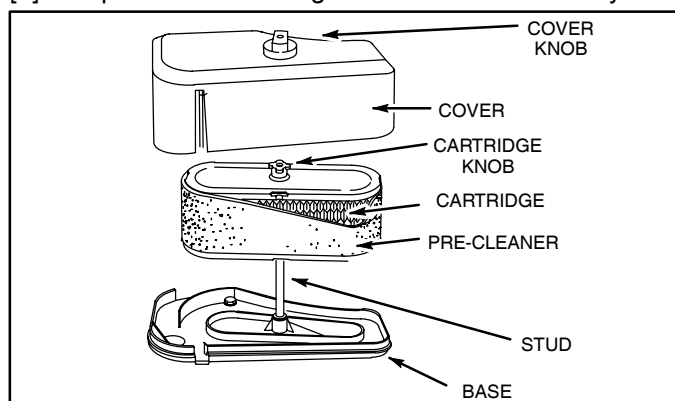



HIGH FLOW AIR CLEANER MAINTENANCE

Perform this maintenance every 25 hours or every season, clean more often under dusty conditions or when airborne debris is present. This filter is made of cotton, which is different from a standard paper filter, therefore it **MUST** be oiled.

- [1] Remove clamp and pull air cleaner from intake manifold.
- [2] Remove as much dirt from the filter as possible.
- [3] Using the High Flow Air Filter Cleaner Kit, Briggs & Stratton part no. 5089D, spray the filter with cleaner. Allow the solution to soak in to the filter for about 15 minutes.

CAUTION: Never use strong detergents, high pressure water, or gasoline to clean this filter.

- [4] Rinse the filter with warm water, inside first and then outside. (Let the water run from the clean side to the dirty side.)
- [5] Allow the filter to dry completely. It is best to allow the filter to dry naturally. Don't use heat, this might shrink the cotton.
- [6] Use only air filter oil, such as the oil included in the cleaning kit (P/N 5089D), to re-oil the filter.



 **WARNING**

Never use motor oil, transmission fluid, WD40, or other oils. Failure to follow instructions can cause fires resulting in death or serious injury. Use only air filter oil designed specifically for air filters.

- [7] Spray the filter with oil, or pour small amount onto each pleat and allow filter to stand for 20 minutes. The filter is correctly oiled when the cotton changes from white to the color of the oil.

CAUTION: DO NOT over-oil air filter, it will interfere with engine performance and may cause engine damage. If the filter is placed on cardboard for 10 minutes and leaves a stain, it is over oiled. Wash/clean and re-oil per above instructions.

- [8] Re-install air filter.

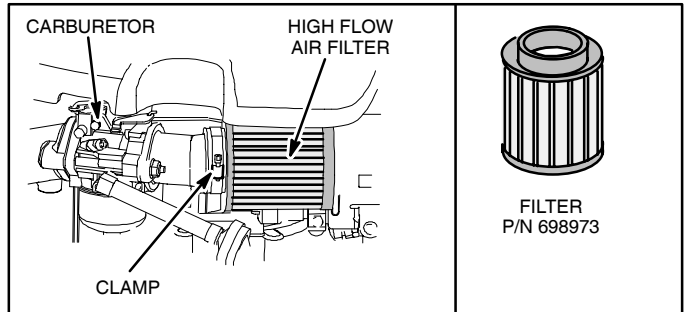

OIL FILTER (IF EQUIPPED)

Replace oil filter after every 100 hours of operation.

- [1] Drain engine oil and remove oil filter.
- [2] Before installing new filter, lightly oil filter gasket with fresh, clean engine oil.
- [3] Screw filter on by hand until gasket contacts oil filter adapter. Tighten 1/2 to 3/4 turn more.
- [4] Add fresh oil. Fill to FULL line on dipstick.
- [5] Start and run engine at idle to check for oil leaks.
- [6] Stop engine. Recheck oil level and add oil if required.

OIL PRESSURE

If oil pressure drops too low, an oil pressure switch (if engine is equipped) will either activate a warning light or stop the engine. Check oil level with dipstick. If oil level is between **ADD** and **FULL** mark on dipstick, Do not try to restart engine. Contact an Authorized Briggs & Stratton Service Dealer. Do not operate engine until oil pressure is corrected.

If oil level is below **ADD** mark on dipstick, add oil to bring level to **FULL** mark. Restart engine and check oil pressure. If pressure is normal, continue to operate engine.

Note: Oil pressure gauge, if engine is equipped, is supplied by manufacturer of equipment.

ENGINE AND ENGINE PARTS

We recommend that you see an authorized Briggs & Stratton Service Dealer for all maintenance and service of the engine and engine parts. Use only genuine Briggs & Stratton parts.

WARNING

WARNING

If you perform any maintenance on the engine, first disconnect the spark plug wire from the spark plug, and disconnect the battery at the negative terminal (electric starter engines only) to prevent unintentional sparking. Unintentional sparking can result in fire or electric shock. Unintentional start-up can result in entanglement, traumatic amputation or laceration. Use only correct tools.

- Do not strike the flywheel with a hammer or hard object because the flywheel may later shatter during operation.
- Do not tamper with governor spring, links or other parts to increase engine speed.

MUFFLER

WARNING

Replacement parts for the muffler must be the same and installed in the same position as the original parts, otherwise fire can occur.

If muffler is equipped with spark arrester screen, remove screen for inspection. Replace screen if damaged or plugged.

SPARK PLUG

Use only Briggs & Stratton Spark Tester (part number 19368) to check for spark.

Note: In some areas, local law requires using resistor spark plug to suppress ignition signals. If this engine was originally equipped with resistor spark plug, use same type for replacement.

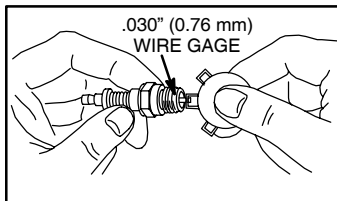

REPLACE FUEL FILTER (if equipped)

WARNING

EXTENDED LIFE SERIES™ FUEL FILTER
PART NO. 695666 OR 5070
(WITH FUEL PUMP)

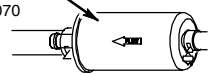

Drain fuel tank or close fuel shut-off valve before replacing fuel filter. Otherwise, fuel can leak out, creating a fire/explosion hazard.

STANDARD FUEL FILTER
PART NO. 394358
(WITH FUEL PUMP)

PART NO. 298090 OR 5018
(WITHOUT FUEL PUMP)

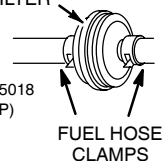

AIR COOLING SYSTEM

Debris may clog the engine's air cooling system. Remove blower housing and clean area shown to prevent overheating and engine damage.

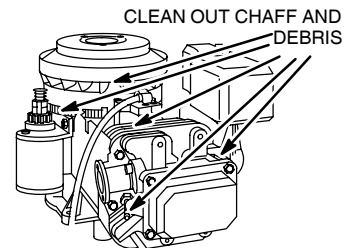

CLEANING DEBRIS

WARNING

Engine parts should be kept clean to reduce the risk of overheating and ignition of accumulated debris. This is especially important if cutting tall grass.

CAUTION: Do not use water to clean engine parts. Water could contaminate fuel system. Use a brush or dry cloth.

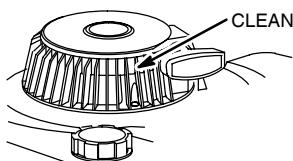

Finger Guard

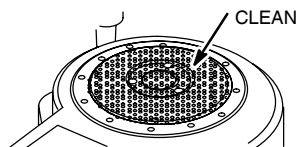

Rotating Screen

Daily or before every use, clean grass, chaff or accumulated debris from engine. Keep linkage, spring and controls clean. Keep area around and behind muffler free of any combustible debris.

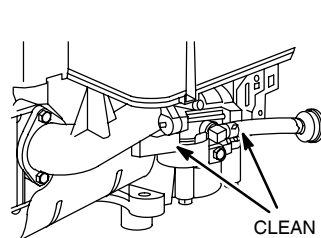

Linkage, Springs, Controls

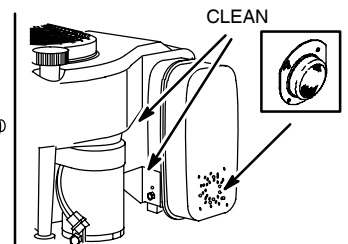

Muffler, Spark Arrester



ADJUSTMENTS

TUNE-UP SPECIFICATIONS

Armature air gap . . . 0.010 – 0.014 in. (0.25 – 0.36 mm)

Spark plug gap 0.030 in. (0.76 mm)

Valve clearance with valve springs installed and piston 1/4 in. (6 mm) past top dead center (check when engine is cold). See Repair Manual P/N 272147.

Intake 0.003 – 0.005 in. (0.08 – 0.13 mm)

Exhaust 0.005 – 0.007 in. (0.13 – 0.18 mm)

CONTROL ADJUSTMENTS

WARNING

TO ADJUST REMOTE THROTTLE

If the engine does not start or if it runs roughly, the remote throttle control may need adjustment. See your authorized Briggs & Stratton dealer or follow the instructions below.

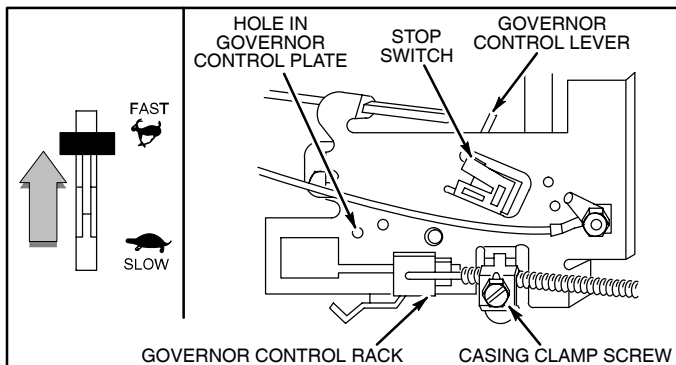

- [1] Move remote throttle control to **FAST** position.
- [2] Hole in governor control lever (located just behind governor control plate) must align with hole in governor control plate, as illustrated above.
- [3] If holes do not line up, loosen casing clamp screw and then move governor control rack until it does.
- [4] Tighten casing clamp screw.
- [5] Check operation of throttle. Move throttle control to **STOP** position.
- [6] Governor control lever must make good contact with stop switch (if equipped). Readjust if necessary.

TO ADJUST REMOTE CHOKE

CASING CLAMP SCREW

- [1] Hold choke control to **CHOKE** or **START** position.
- [2] Loosen casing clamp screw.
- [3] Pull casing, wire and choke lever in direction of arrow to end of travel.
- [4] Tighten casing clamp screw.

CARBURETOR ADJUSTMENT

WARNING

The manufacturer of the equipment on which this engine is installed specifies top speed at which the engine will be operated. **DO NOT EXCEED** this speed.

Differences in fuel, temperature, altitude or load may require minor carburetor adjustment. Air cleaner and its cover must be assembled to carburetor before starting engine.

The carburetor on this engine is equipped with an idle mixture valve with a limiter (see inset), which allows some adjustment, and an idle speed adjustment screw.

TO ADJUST CARBURETOR

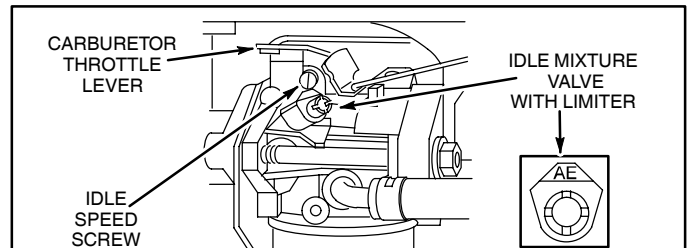

- [1] To adjust idle speed, start engine and warm up about 5 minutes.
- [2] With engine running, place equipment throttle control in **SLOW** position.
- [3] Rotate carburetor throttle lever against the idle speed screw and hold it. Turn idle speed screw to obtain 1750 rpm (use a tachometer).
- [4] Then rotate idle mixture valve full travel clockwise and then counterclockwise.
- Note:** **DO NOT** remove limiter caps. **DO NOT** force beyond limits.
- [5] Then, position idle mixture valve in middle of travel.
- [6] Check idle speed. Re-adjust to 1750 rpm, if needed.
- [7] Move throttle control to **FAST** position. Engine should accelerate smoothly. If it does not, adjust idle mixture valve counterclockwise 1/8 turn.

Note: Engines operated at approximately 3000 to 5000 feet (900 to 1500 meters) above sea level may require a high altitude carburetor nozzle. If erratic performance is observed, contact a Briggs & Stratton Authorized Service Dealer for cost to install/purchase a high altitude carburetor nozzle.

SERVICE & STORAGE

BRIGGS & STRATTON

PARTIAL LIST OF BRIGGS & STRATTON PARTS

Models 280000, 310000 AVS™ series

Extended Life Series™ flat air cleaner cartridge	697153
(washable, no pre-cleaner required)	
Extended Life Series™ Maintenance Kit	5128
(Includes oil, A/C filter, spark plug, gas additive)	
Flat air cleaner cartridge and pre-cleaner kit	5077
Flat air cleaner cartridge	698083
Flat air cleaner pre-cleaner	697015
Maintenance Kit	5127
(Includes oil, A/C filter, spark plug, gas additive)	

Model 210000 AVS™ series

Flat air cleaner cartridge and pre-cleaner kit	5079
Flat air cleaner cartridge	698413
Flat air cleaner pre-cleaner	697292
Maintenance Kit	5126
(Includes oil, A/C filter, spark plug, gas additive)	

Oval air cleaner cartridge and pre-cleaner kit	5053
Oval air cleaner cartridge	496894
Oval air cleaner pre-cleaner	272403
High Flow Air Filter (cylinder)	698973
High Flow Air Filter Cleaning Kit	5089D
Synthetic Oil (32 oz.)	100074
Oil (20 oz.)	100005
Oil (48 oz.)	100028
Oil filter (3-1/2 in. long)	491056
Oil filter (2-1/4 in. long)	492932
Fuel filter	298090 -or- 5018
(for engines without fuel pump installed)	
Extended Life Series™ fuel filter	695666 -or- 5070
(for engines equipped with fuel pump)	
Fuel filter	394358
(for engines equipped with fuel pump)	
Gas additive	5041
Resistor spark plug	491055
Long life platinum spark plug	5066
(used on most OHV engines)	
Spark plug wrench	89838 -or- 5023
Spark tester	19368
Oil pump kit	5056
(uses standard electric drill to remove oil from engine quickly)	

SERVICE

See an Authorized Briggs & Stratton Service Dealer. Each one carries a stock of Genuine Briggs & Stratton Parts and is equipped with special service tools. Trained mechanics assure expert repair service on all Briggs & Stratton engines. Only dealers advertising as "Authorized Briggs & Stratton" are required to meet Briggs & Stratton standards.

When you purchase equipment powered by a Briggs & Stratton engine, you are assured of highly skilled, reliable service at more than 30,000 Authorized Service Dealers worldwide, including more than 5,000 Master Service Technicians. Look for these signs wherever Briggs & Stratton service is offered.



You may locate your nearest Authorized Briggs & Stratton Service Dealer in our dealer locator map on our web site www.briggsandstratton.com or in the "Yellow Pages™"



directory under "Engines, Gasoline" or "Gasoline Engines," or "Lawn Mowers" or similar category.

Note: Walking fingers logo and "Yellow Pages" are registered trademarks in various jurisdictions.

An illustrated shop manual includes common specifications and detailed information covering adjustment, tune-up and repair of Briggs & Stratton single cylinder, OHV, 4 cycle engines. It is available for purchase from an Authorized Briggs & Stratton Service Dealer or you can order it from the factory. Write:

Briggs & Stratton Corporation
Attn: Service Division
P. O. Box 1144
Milwaukee, WI 53201

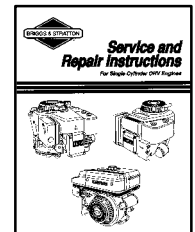

Part No. 272147

STORAGE

Engines stored over 30 days need special attention.

- [1] To prevent gum from forming in fuel system or on essential carburetor parts:
 - a) if fuel tank contains oxygenated or reformulated gasoline (gasoline blended with an alcohol or an ether), run engine until it stops from lack of fuel, **or** b) if fuel tank contains gasoline, either run engine until it stops from lack of fuel, or add a gasoline additive to the gas in the tank. (See parts list. Single – use pouches of gas additive are available from your service dealer.) If you use a gas additive, run the engine for several minutes to circulate the additive through the carburetor. Then, engine and fuel can be stored up to 24 months.
- [2] While engine is still warm, change oil.
- [3] Remove spark plug and pour about 1 oz. (30 ml) of engine oil into cylinder. Replace spark plug and crank slowly to distribute oil.
- [4] Clean engine of surface debris, chaff or grass.

[5]



Store in a clean, dry area. Do not store in same area as a stove, furnace, water heater, or other appliance that uses a pilot light or has a device that can create a spark.

BRIGGS & STRATTON ENGINE OWNER WARRANTY POLICY

Effective January 1, 2003 replaces all undated Warranties and all Warranties dated before January 1, 2003

LIMITED WARRANTY

Briggs & Stratton Corporation will repair or replace, free of charge, any part(s) of the engine that is defective in material or workmanship or both. Transportation charges on parts submitted for repair or replacement under this warranty must be borne by purchaser. This warranty is effective for the time periods and subject to the conditions stated below. For warranty service, find the nearest Authorized Service Dealer in our dealer locator map at www.briggsandstratton.com, or by calling 1-800-233-3723, or as listed in the 'Yellow Pages™'.

THERE IS NO OTHER EXPRESS WARRANTY. IMPLIED WARRANTIES, INCLUDING THOSE OF MERCHANTABILITY AND FITNESS FOR A PARTICULAR PURPOSE, ARE LIMITED TO ONE YEAR FROM PURCHASE, OR TO THE EXTENT PERMITTED BY LAW ANY AND ALL IMPLIED WARRANTIES ARE EXCLUDED. LIABILITY FOR INCIDENTAL OR CONSEQUENTIAL DAMAGES ARE EXCLUDED TO THE EXTENT EXCLUSION IS PERMITTED BY LAW. Some states or countries do not allow limitations on how long an implied warranty lasts, and some states or countries do not allow the exclusion or limitation of incidental or consequential damages, so the above limitation and exclusion may not apply to you. This warranty gives you specific legal rights and you may also have other rights which vary from state to state and country to country.

OUR PRODUCT

Vanguard™	ELS™ I/C® Industrial Plus™ Intek™ (Sleeve Bore)	Force™ Intek™ (Kool Bore) Power Built™ OHV Quantum® Quattro™ Q45™ Sprint™	Classic™	Etek™
------------------	---	---	-----------------	--------------

WARRANTY PERIOD*

Consumer Use	2 years	2 years	2 years	1 year	1 year
Commercial Use	2 years	1 year	90 days	90 days	1 year

* **Note the following special warranty periods: 2 years** for Classic™ engines in the European Union and Eastern European countries, for all consumer products in the European Union, and for emission control systems on engines certified by EPA and CARB. **5 years** for consumer use, 90 days for commercial use of Touch-N-Mow® starter on Quantum® and Intek™ engines. **Engines used in competitive racing or on commercial or rental tracks are not warranted.**

The warranty period begins on the date of purchase by the first retail consumer or commercial end user, and continues for the period of time stated in the table above. "Consumer use" means personal residential household use by a retail consumer. "Commercial use" means all other uses, including use for commercial, income producing or rental purposes. Once an engine has experienced commercial use, it shall thereafter be considered as a commercial use engine for purposes of this warranty.

NO WARRANTY REGISTRATION IS NECESSARY TO OBTAIN WARRANTY ON BRIGGS & STRATTON PRODUCTS. SAVE YOUR PROOF OF PURCHASE RECEIPT. IF YOU DO NOT PROVIDE PROOF OF THE INITIAL PURCHASE DATE AT THE TIME WARRANTY SERVICE IS REQUESTED, THE MANUFACTURING DATE OF THE PRODUCT WILL BE USED TO DETERMINE THE WARRANTY PERIOD.

ABOUT YOUR ENGINE WARRANTY

Briggs & Stratton welcomes warranty repair and apologizes to you for being inconvenienced. Any Authorized Service Dealer may perform warranty repairs. Most warranty repairs are handled routinely, but sometimes requests for warranty service may not be appropriate. For example, warranty would not apply if engine damage occurred because of misuse, lack of routine maintenance, shipping, handling, warehousing or improper installation. Similarly, warranty is void if the serial number of the engine has been removed or the engine has been altered or modified.

If a customer differs with the decision of the Service Dealer, an investigation will be made to determine whether the warranty applies. Ask the Service Dealer to submit all supporting facts to his Distributor or the Factory for review. If the Distributor or the Factory decides that the claim is justified, the customer will be fully reimbursed for those items that are defective. To avoid misunderstanding which might occur between the customer and the Dealer, listed below are some of the causes of engine failure that the warranty does not cover.

Normal wear:

Engines, like all mechanical devices, need periodic parts service and replacement to perform well. Warranty will not cover repair when normal use has exhausted the life of a part or an engine.

Improper maintenance:

The life of an engine depends upon the conditions under which it operates, and the care it receives. Some applications, such as tillers, pumps and rotary mowers, are very often used in dusty or dirty conditions, which can cause what appears to be premature wear. Such wear, when caused by dirt, dust, spark plug cleaning grit, or other abrasive material that has entered

the engine because of improper maintenance, is not covered by warranty.

This warranty covers engine related defective material and/or workmanship only, and not replacement or refund of the equipment to which the engine may be mounted. Nor does the warranty extend to repairs required because of:

1. PROBLEMS CAUSED BY PARTS THAT ARE NOT ORIGINAL BRIGGS & STRATTON PARTS.
2. Equipment controls or installations that prevent starting, cause unsatisfactory engine performance, or shorten engine life. (Contact equipment manufacturer.)
3. Leaking carburetors, clogged fuel pipes, sticking valves, or other damage, caused by using contaminated or stale fuel. (Use clean, fresh, lead-free gasoline and Briggs & Stratton Fuel Stabilizer, Part No. 5041.)
4. Parts which are scored or broken because an engine was operated with insufficient or contaminated lubricating oil, or an incorrect grade of lubricating oil (check oil level daily or after every 8 hours of operation. Refill when necessary and change at recommended intervals.) OIL GARD® may not shut down running engine. Engine damage may occur if oil level is not properly maintained. Read Operating & Maintenance Instructions.
5. Repair or adjustment of associated parts or assemblies such as clutches, transmissions, remote controls, etc., which are not manufactured by Briggs & Stratton.
6. Damage or wear to parts caused by dirt, which entered the engine because of improper air cleaner maintenance, re-assembly, or use of a non-original air cleaner element or cartridge. (At recommended

7. intervals, clean and re-oil the Oil-Foam® element or the foam pre-cleaner, and replace the cartridge.) Read Operating & Maintenance Instructions.
7. Parts damaged by over-speeding, or overheating caused by grass, debris, or dirt, which plugs or clogs the cooling fins, or flywheel area, or damage caused by operating the engine in a confined area without sufficient ventilation. (Clean fins on the cylinder, cylinder head and flywheel at recommended intervals.) Read Operating & Maintenance Instructions.
8. Engine or equipment parts broken by excessive vibration caused by a loose engine mounting, loose cutter blades, unbalanced blades or loose or unbalanced impellers, improper attachment of equipment to engine crankshaft, over-speeding or other abuse in operation.
9. A bent or broken crankshaft, caused by striking a solid object with the cutter blade of a rotary lawn mower, or excessive v-belt tightness.
10. Routine tune-up or adjustment of the engine.
11. Engine or engine component failure, i.e., combustion chamber, valves, valve seats, valve guides, or burned starter motor windings, caused by the use of alternate fuels such as, liquified petroleum, natural gas, altered gasolines, etc.

Warranty is available only through service dealers which have been authorized by Briggs & Stratton Corporation. your nearest Authorized Service Dealer is listed in the "Yellow Pages™" of your telephone directory under "Engines, Gasoline" or "Gasoline Engines," "Lawn Mowers," or similar category.

**Briggs & Stratton Corporation (B&S), the California Air Resources Board (CARB)
and the United States Environmental Protection Agency (U.S. EPA)
Emission Control System Warranty Statement (Owner's Defect Warranty Rights and Obligations)**

EMISSION CONTROL WARRANTY COVERAGE IS APPLICABLE TO CERTIFIED ENGINES PURCHASED IN CALIFORNIA IN 1995 AND THEREAFTER, WHICH ARE USED IN CALIFORNIA, AND TO CERTIFIED MODEL YEAR 1997 AND LATER ENGINES WHICH ARE PURCHASED AND USED ELSEWHERE IN THE UNITED STATES (AND AFTER JANUARY 1, 2001 IN CANADA).

California and United States Emission Control Defects Warranty Statement

The California Air Resources Board (CARB), U.S. EPA and B&S are pleased to explain the Emission Control System Warranty on your model year 2002 and later small off-road engine (SORE). In California, new small off-road engines must be designed, built and equipped to meet the State's stringent anti-smog standards.

Elsewhere in the United States, new non-road, spark-ignition engines certified for model year 1997 and later must meet similar standards set forth by the U.S. EPA. B&S must warrant the emission control system on your engine for the periods of time listed below, provided there has been no abuse, neglect or improper maintenance of your small off-road engine.

Your emission control system includes parts such as the carburetor, air cleaner, ignition system, muffler and catalytic converter. Also included may be connectors and other emission related assemblies.

Where a warrantable condition exists, B&S will repair your small off-road engine at no cost to you including diagnosis, parts and labor.

Briggs & Stratton Emission Control Defects Warranty Coverage

Small off-road engines are warranted relative to emission control parts defects for a period of two years, subject to provisions set forth below. If any covered part on your engine is defective, the part will be repaired or replaced by B&S.

Owner's Warranty Responsibilities

As the small off-road engine owner, you are responsible for the performance of the required maintenance listed in your Operating and Maintenance Instructions. B&S recommends that you retain all your receipts covering maintenance on your small off-road engine, but B&S cannot deny warranty solely for the lack of receipts or for your failure to ensure the performance of all scheduled maintenance.

As the small off-road engine owner, you should however be aware that B&S may deny you warranty coverage if your small off-road engine or a part has failed due to abuse, neglect, improper maintenance or unapproved modifications. You are responsible for presenting your small off-road engine to an Authorized B&S Service Dealer as soon as a problem exists.

The undisputed warranty repairs should be completed in a reasonable amount of time, not to exceed 30 days.

If you have any questions regarding your warranty rights and responsibilities, you should contact a B&S Service Representative at 1-414-259-5262.

The emission warranty is a defects warranty. Defects are judged on normal engine performance. The warranty is not related to an in-use emission test.

Briggs & Stratton Emission Control Defects Warranty Provisions

The following are specific provisions relative to your Emission Control Defects Warranty Coverage. It is in addition to the B&S engine warranty for non-regulated engines found in the Operating and Maintenance Instructions.

1. **Warranted Parts**
Coverage under this warranty extends only to the parts listed below (the emission control systems parts) to the extent these parts were present on the engine purchased.
 - a. **Fuel Metering System**
 - Cold start enrichment system
 - Carburetor and internal parts
 - Fuel Pump
 - b. **Air Induction System**
 - Air cleaner
 - Intake manifold
 - c. **Ignition System**
 - Spark plug(s)
 - Magneto ignition system
 - d. **Catalyst System**
 - Catalytic converter
 - Exhaust manifold
 - Air injection system, Pulse valve
 - e. **Miscellaneous Items**
 - Vacuum, temperature, position, time sensitive valves and switches
 - Connectors and assemblies
2. **Length of Coverage**
B&S warrants to the initial owner and each subsequent purchaser that the Warranted Parts shall be free from defects in materials and workmanship which caused the failure of the Warranted Parts for a period of two years from the date the engine is delivered to a retail purchaser.
3. **No Charge**
Repair or replacement of any Warranted Part will be performed at no charge to the owner, including diagnostic labor which leads to the determination that a Warranted Part is defective, if the diagnostic work is performed at an Authorized B&S Service Dealer. For emissions warranty service contact your nearest Authorized B&S Service Dealer as listed in the "Yellow Pages" under "Engines, Gasoline," "Gasoline Engines," "Lawn Mowers," or similar category.
4. **Claims and Coverage Exclusions**
Warranty claims shall be filed in accordance with the provisions of the B&S Engine Warranty Policy. Warranty coverage shall be excluded for failures of Warranted Parts which are not original B&S parts or because of abuse, neglect or improper maintenance as set forth in the B&S Engine Warranty Policy. B&S is not liable to cover failures of Warranted Parts caused by the use of add-on, non-original, or modified parts.
5. **Maintenance**
Any Warranted Part which is not scheduled for replacement as required maintenance or which is scheduled only for regular inspection to the effect of "repair or replace as necessary" shall be warranted as to defects for the warranty period. Any Warranted Part which is scheduled for replacement as required maintenance shall be warranted as to defects only for the period of time up to the first scheduled replacement for that part. Any replacement part that is equivalent in performance and durability may be used in the performance of any maintenance or repairs. The owner is responsible for the performance of all required maintenance, as defined in the B&S Operating and Maintenance Instructions.
6. **Consequential Coverage**
Coverage hereunder shall extend to the failure of any engine components caused by the failure of any Warranted Part still under warranty.

Briggs & Stratton Engines Are Made Under One Or More Of The Following Patents: Design D-247,177 (Other Patents Pending)										
6,325,036	6,077,063	5,819,513	5,606,948	5,497,679	5,235,943	5,138,996	4,996,956	4,633,556	4,430,984	DES. 308,871
6,284,123	6,064,027	5,813,384	5,606,851	5,320,795	5,197,425	5,086,890	4,977,879	4,630,498		DES. 308,872
6,260,529	6,014,808	5,765,713	5,548,955	5,271,363	5,197,422	5,070,829	4,971,219	4,522,080		DES. 309,457
6,230,678	5,894,715	5,645,025	5,546,901	5,269,713	5,191,864	5,058,544	4,895,119	4,520,288		DES. 356,951
6,202,616	5,852,951	5,642,701	5,503,125	5,265,700	5,188,069	5,040,644	4,819,593	4,512,499		DES. 361,771
6,116,212	5,823,153	5,619,845	5,501,203	5,243,878	5,186,142	5,009,208	4,719,682	4,453,507		DES. 375,963

La Corporation Briggs & Stratton (B&S), le California Air Resources Board (CARB) et le Bureau de protection environnementale des Etats-Unis (US EPA)

Garantie sur le système d'échappement (Garantie contre les défauts, droits et obligations du propriétaire)

LA GARANTIE SUR LE SYSTÈME D'ÉCHAPPEMENT EST APPLICABLE SUR LES MOTEURS CERTIFIÉS ACHETÉS EN CALIFORNIE EN 1995 ET LES ANNÉES SUIVANTES ET QUI SONT UTILISÉS EN CALIFORNIE, AINSI QU'ÀUX MODÈLES CERTIFIÉS DE 1997 ET LES ANNÉES SUI-

VANTES QUI ONT ÉTÉ ACHETÉS ET UTILISÉS AILLEURS AUX ETATS-UNIS (ET APRÈS LE 1ER JANVIER 2001 AU CANADA).

Déclaration de garantie sur le système d'échappement pour la Californie, les Etats-Unis

Le California Air Resources Board (CARB), le Bureau américain de protection environnementale (U.S. EPA) et B & S sont heureux d'expliquer la garantie sur le système d'échappement des petits moteurs hors-route de votre modèle 2000 et des années ultérieures (SORE). En Californie, les nouveaux petits moteurs hors route doivent être conçus, construits et équipés pour rencontrer les standards rigoureux d'antipollution. Ailleurs aux Etats-Unis, les nouveaux moteurs hors route à bougie d'allumage certifiés pour les modèles de 1997 et plus, doivent rencontrer des normes similaires mises de l'avant par le U.S. EPA. Briggs & Stratton garantit le système de contrôle d'échap-

pement de votre moteur pour la période de temps mentionnée ci-contre, sauf s'il a fait l'objet d'abus, de négligence ou d'un entretien inapproprié.

Votre système de contrôle d'échappement comprend des pièces telles que le carburateur, le filtre à air, le système d'ignition, le silencieux et le convertisseur catalytique. Il peut aussi comprendre les connecteurs et autres pièces reliées à l'émission.

Lorsqu'il y a condition à garantie, B&S réparera gratuitement votre petit moteur hors-route incluant le diagnostic, les pièces et la main d'œuvre.

Couverture de garantie Briggs & Stratton contre toute défectuosité du système de contrôle d'échappement

Les petits moteurs hors route sont garantis contre la défectuosité des pièces du système de contrôle d'échappement pour une période de 2 ans, sujette aux conditions stipulées ci-contre. Si n'impor-

te quelle pièce de votre moteur couverte par cette garantie est défectueuse, elle sera réparée ou remplacée par B&S.

Responsabilités du propriétaire

En tant que propriétaire d'un petit moteur hors route, vous êtes responsable de veiller à l'exécution de l'entretien requis tel que stipulé dans votre manuel d'opération et d'entretien. B&S vous recommande de conserver tous les reçus couvrant les travaux d'entretien de votre petit moteur hors route, mais B&S ne peut refuser la garantie en raison d'absence de reçus ou pour défaut d'avoir suivi tout l'échéancier du programme d'entretien.

Vous avez la responsabilité d'apporter votre petit moteur hors route à un détaillant autorisé B&S aussitôt que survient un problème. Les réparations sous garantie doivent être complétées dans un délai raisonnable ne devant pas excéder 30 jours.

Si vous avez des questions relativement à votre garantie, vos droits et responsabilités, veuillez communiquer avec un représentant de service B&S au numéro 1-414-259-5262.

En tant que propriétaire d'un petit moteur hors route, vous devez être informé que B&S peut refuser d'honorer cette garantie si la défectuosité de votre moteur ou d'une partie de votre moteur est due à un emploi abusif, une négligence, un entretien incorrect ou une modification non approuvée.

La garantie du système d'échappement est une garantie contre les défauts. Les défauts sont jugés en fonction d'une utilisation normale du moteur. La garantie n'est pas reliée à un test d'échappement effectué à l'intérieur.

Dispositions de la garantie du système d'échappement Briggs & Stratton

Ce qui suit concerne les dispositions spécifiques relativement à votre garantie sur le système de contrôle d'échappement. C'est une addition à la garantie B&S pour les moteurs non réglementés contenue dans le manuel d'entretien et d'utilisation.

1. Pièces sous garantie

La couverture de cette garantie ne s'applique que sur les pièces listées ci-contre (les parties du système de contrôle d'échappement) dans la mesure où ces pièces étaient présentes sur le moteur au moment de l'achat.

- a. Système de dosage du carburant
 - Système d'enrichissement de démarrage à froid
 - Carburateur et parties internes
 - Pompe à essence
- b. Système d'induction d'air
 - Filtre à air
 - Tubulure d'admission
- c. Système d'ignition
 - Bougies d'allumage
 - Système d'allumage électromagnétique
- d. Système catalyseur
 - Convertisseur catalytique
 - Collecteur d'échappement
 - Système d'injection d'air ou à pulsion
- e. Autres pièces utilisées dans les systèmes ci-haut mentionnés
 - Soupapes et interrupteurs de dépression, de température, de position.
 - Connecteurs et assemblages.

2. Durée de la couverture

B&S garantit le propriétaire initial et tous les acheteurs subséquents que les pièces sous garantie sont exemptes de vice de matière ou de fabrication qui pourraient causer des défauts des pièces sous garantie pour une période de deux ans à partir de la date à laquelle le moteur a été livré à l'acheteur.

3. Aucuns Frais

La réparation ou le remplacement de toute pièce sous garantie sera effectuée sans aucuns frais pour le propriétaire, incluant les frais de main d'œuvre pour le diagnostic afin de déterminer si la pièce sous garantie est défectueuse, conditionnel à ce que le diagnostic soit effectué chez un détaillant autorisé B&S. Pour la garantie relative au système d'échappement, communiquez avec le détaillant autorisé B&S le plus proche tel que listé dans les pages jaunes de votre localité sous la rubrique moteur à essence, tondeuse ou autre catégorie similaire.

4. Réclamations et exclusions de la couverture.

Les réclamations de garantie doivent être complétées en accord avec les dispositions de la politique de garantie B&S. La garantie ne couvre pas les défauts de pièces qui ne sont pas des pièces d'origine B&S ou dans le cas d'abus, négligence ou d'un entretien inapproprié. La garantie B&S ne couvre pas les défauts de pièces sous garantie qui ont fait l'objet d'ajouts, ont été modifiées ou de pièces qui ne sont pas des pièces B&S d'origine.

5. Entretien

Toute pièce sous garantie qui n'est pas remplacée au moment requis selon le manuel d'entretien ou qui est planifiée seulement pour une inspection régulière sous la mention « réparer ou remplacer si nécessaire » est garantie contre toute défectuosité pour la période de garantie. Toute pièce sous garantie qui est planifiée pour un remplacement tel que requis dans l'entretien est garantie contre toute défectuosité seulement pour la période de temps qui va jusqu'au premier remplacement prévu pour cette pièce. Toute pièce de remplacement équivalente en performance et durabilité peut être utilisée pour l'entretien ou la réparation. Le propriétaire est responsable de l'exécution de tout entretien requis tel que défini dans le manuel d'instruction B&S sur l'entretien et la réparation.

6. Couverture indirecte

La couverture ci-contre s'étend à toute défectuosité des composantes du moteur causée par la défectuosité de n'importe quelle pièce couverte par la garantie et dont la garantie est encore en vigueur.

Consultez les informations sur la période de durabilité d'émission et l'INDICE d'air sur l'étiquette d'émission de votre moteur

Les moteurs qui sont certifiés conformes aux normes standards d'émission du California Air Resources Board (CARB) Tier 2, doivent afficher l'information concernant la période de durabilité du système d'émission et l'INDICE d'air. Cette information est indiquée sur les étiquettes apposées sur les moteurs par Briggs & Stratton. L'étiquette du moteur indiquera les renseignements concernant la certification. La **période de durabilité d'émission** indique le nombre d'heures d'utilisation normale pour lequel le moteur est certifié conforme aux normes d'émission sous réserve d'un entretien approprié tel qu'indiqué dans le manuel d'opération et d'entretien. Les catégories suivantes sont utilisées :

Modéré le moteur est certifié conforme pour 125 heures d'utilisation normale.

Intermédiaire le moteur est certifié conforme pour 250 heures d'utilisation normale.

Prolongé le moteur est certifié conforme pour 500 heures d'utilisation normale.

Par exemple, une tondeuse de modèle standard est utilisée environ 20 à 25 heures par année. Par conséquent, la **période de durabilité d'émission** d'un moteur dans la catégorie intermédiaire pour ce type de tondeuse équivaut à 10 à 12 ans.

L'**indice d'air** est un nombre qui décrit le niveau relatif d'émission pour une catégorie spécifique de moteur. Plus l'**indice d'air** est bas, plus le moteur est écologique. Cette information est indiquée sous une forme graphique sur l'étiquette d'émission.

A compter du 1^{er} juillet 2000, surveillez la période de conformité d'émission sur les étiquettes

Après le 1^{er} juillet 2000, certains moteurs B&S seront certifiés conformes aux normes environnementales d'émission standard du United States Environmental Protection Agency (US EPA) Phase 2. Pour les moteurs certifiés pour la Phase 2, la période de conformité d'émission mentionnée sur les étiquettes indique le nombre d'heures d'utilisation pour lequel le moteur rencontre les normes fédérales. Pour les moteurs de force moindre que 225 cc, la catégorie C = 125 heures, B = 250 heures et A = 500 heures. Pour les moteurs de 225 cc et plus, la catégorie C = 250 heures, B = 500 heures et A = 1000 heures. Le remplacement du moteur portant le modèle de série 210000 est 344 cc, 280000 est 465 cc, et 310000 est 501 cc.

Ceci est une représentation des étiquettes d'émission que vous retrouverez sur les moteurs certifiés :

