

HANNSpree

HANNSPREE CALIFORNIA, INC.

843 Auburn Court,
Fremont, CA 94538, U.S.A.
TEL: 1-510-360-3000
FAX: 1-510-360-3001
www.hannspree.com

HANNSpree

15" Liquid Crystal Display Television

User's Manual

Table of Contents

1. Regulatory Information.....	3
2. Description of Warning Symbols.....	5
3. Safety Notices.....	6
4. Preface.....	13
5. Introducing the TV.....	15
Features.....	15
6. Checking Package Contents.....	16
7. Getting Started.....	17
Control Panel.....	17
Input and Output Jacks.....	18
Remote Control.....	19
Inserting the Remote Control Batteries.....	21
8. Making Connections.....	23
Connecting to an Antenna or Cable TV.....	23
Connecting to AV Devices.....	24
Connecting to a VCR, VCD or DVD Player.....	24
Connecting to a Video Camera.....	25
Connecting to a Video Game Console.....	26
Connecting Headphones.....	27
Connecting an Amplifier or Speakers (Built-in amplifier).....	28
Connecting the Power Adapter.....	29
9. Using the TV.....	30
Turning the TV On and Off.....	30
Switching Source Signals.....	30
Adjusting the Volume.....	30
Selecting Channels.....	30
Using the Remote Control.....	31
Using the Favorite Channel Feature.....	31
MTS.....	32
10. Adjusting On-Screen Display (OSD) Settings.....	33
Picture Setting.....	34
Brightness.....	35
Contrast.....	36

Table of Contents

Sharpness	37
Hue	38
Saturation	39
Black Level	40
Color	41
Preset	42
Audio Setting	43
Treble	44
Bass	45
Balance	46
Surround	47
Enhance	47
Preset	48
TV Setting	49
TV/CATV	50
Channel Add/Erase	51
Auto Program	52
Customize Setting	53
Sleep Timer	54
OSD Timeout	55
Language	55
CC/TEXT (Closed Caption)	56
Parental	57
11. Taking Care of Your TV & Remote Control	63
12. Troubleshooting	64
13. Warranty and Service	66
14. Specifications	67
15. Glossary	68

FCC Compliance Statement¹

This device complies with part 15 of the FCC Rules. Operation is subject to the following two conditions: (1) This device may not cause harmful interference, and (2) this device must accept any interference received, including interference that may cause undesired operation.

Additional Information

This equipment has been tested and found to comply with the limits for a Class B digital device, pursuant to part 15 of the FCC Rules. These limits are designed to provide reasonable protection against harmful interference in a residential installation. This equipment generates, uses and can radiate radio frequency energy and, if not installed and used in accordance with the instructions, may cause harmful interference to radio communications. However, there is no guarantee that interference will not occur in a particular installation. If this equipment does cause harmful interference to radio or television reception, which can be determined by turning the equipment off and on, the user is encouraged to try to correct the interference by one or more of the following measures:

- Reorient or relocate the receiving antenna
- Increase the separation between the equipment and receiver
- Connect the equipment into an outlet on a circuit different from that to which the receiver is connected
- Consult the dealer or an experienced radio/TV technician for help

Warning: You are cautioned that changes or modifications not expressly approved by the party responsible for compliance could void your authority to operate the equipment.

1. applies only to products purchased in the United States of America

DOC Compliance Notice¹

This digital apparatus does not exceed the Class B limits for radio noise emissions from digital apparatus as set out in the Radio Interference Regulations of the Canadian Department of Communications. This device complies with Canada ICES-003 Class B.

CE Conformity Statement²

This device complies with the requirements set out in the Council Directive on the approximation of the Laws of the Member States relating to Electromagnetic Compatibility (89/336/EEC) and the Amendment Directive (92/31/EEC), Low-Voltage Directive (73/23/EEC) and the Amendment Directive (93/68/EEC).

-
1. applies only to products purchased in Canada
 2. applies only to products purchased in the European Union

Description of Warning Symbols



Before You Proceed

1. Read all Safety Notices in Section 2 of this manual and instructions in the User's Manual carefully before either plugging in or turning the TV on.
2. Keep this User's Manual in a safe place for future reference. Keep the box and packaging in case the TV needs to be shipped in the future.
3. Follow the TV and warning label instructions.
4. Any uses, operations, changes, alterations or modifications of the TV that do not follow the instructions in this manual will void this TV's warranty.



CAUTION

RISK OF ELECTRIC SHOCK
DO NOT OPEN



WARNING



This symbol is used to alert users to pay attention to important descriptions regarding usage, maintenance (repair), and additional important information related to this TV.

CAUTION



This symbol is used to alert users to the risk of electric shocks due to dangerous and uninsulated components.

Electric Power Notice

Electric power may cause personal injury and mechanical damage if misused. Although safety has been taken into consideration during the design and production of this TV, electric shock or fire can result if the TV is misused. To prevent potential danger, read and follow the instructions and warnings contained in this manual when setting up, operating or cleaning the TV. In addition, please read all “Safety Notices” contained in this manual carefully before using the TV.

**Power Supply Safety Notes**

1. To avoid electric shocks, do not use an extended power cord or an outlet that does not match this TV's plug or leaves the plug exposed.
2. This TV has a 3-pin grounded plug. The third pin connects to ground; do not remove it or alter it in anyway.
3. If the power cord or plug is damaged or worn, unplug it immediately and contact an authorized service technician for maintenance.
4. To avoid fire or electric shocks, do not overload electric power outlets.



Installation Safety Notes

Antenna

We suggest that you use an outdoor antenna to get the best signal possible unless you have cable TV or a centralized indoor antenna system. You may, however, use an antenna indoors if it is placed in a location free from interference.

Location

Avoid prolonged exposure to sunlight or other strong sources of heat. Leave sufficient distance between the TV and the wall to provide enough space for the emission of heat.



WARNING

To reduce the risk of fire or electric shock, do not expose this apparatus to rain or moisture.

Apparatus shall not be exposed to dripping or splashing and no objects filled with liquids, such as vases, shall be placed on the apparatus.



Power

To avoid danger of fires or electric shock, only use those adapters listed below, which are compatible with this TV.

- EDAC POWER ELECTRONICS CO., LTD.: EA1050A-120
- LI SHIN INTERNATIONAL ENTERPRISE CORP.: 0218B1260

IMPORTANT SAFETY INSTRUCTIONS



- 1 Read these instructions.
 - 2 Keep these instructions.
 - 3 Heed all warnings.
 - 4 Follow all instructions.
-



- 5 Do not use this apparatus near water.
-



- 6 Clean only with dry cloth.
-



- 7 Do not block any ventilation openings. Install in accordance with manufacturer's instructions.
-



- 8 Do not install near any heat sources such as radiators, heat registers, stoves, or other apparatus (including amplifiers) that produce heat.
-

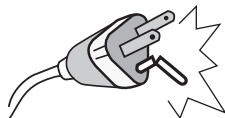

- 9 Do not defeat the safety purpose of the polarized or grounding-type plug. A polarized plug has two blades with one wider than the other. A grounding-type plug has two blades and a third grounding prong. The wide blade or the third prong are provided for your safety. If the provided plug does not fit into your outlet, consult an electrician for replacement of the obsolete outlet.
-

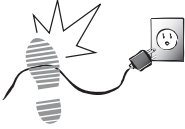

- 10 Protect the power cord from being walked on or pinched, particularly at plugs, convenience receptacles, and the point where they exit from the apparatus.



- 11 Only use attachments/accessories specified by the manufacturer.



- 12 Use only with the cart, stand, tripod, bracket, or table specified by the manufacturer, or sold with the apparatus. When a cart is used, use caution when moving the cart/apparatus combination to avoid injury from tip-over.



- 13 Unplug this apparatus during lightning storms or when unused for long periods of time.



- 14 Refer all servicing to qualified service personnel. Servicing is required when the apparatus has been damaged in any way, such as power-supply cord or plug is damaged, liquid has been spilled or objects have fallen into the apparatus, the apparatus has been exposed to rain or moisture, does not operate normally, or has been dropped.

CAUTION



These servicing instructions are for use by qualified service personnel only. To reduce the risk of electric shock, do not perform any servicing other than that contained in the operating instructions unless you are qualified to do so.

Personal Safety

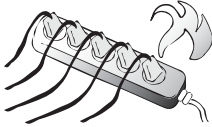

To avoid overloading the power supply, never plug too many electrical devices into an outlet, power strip, or extension cable.

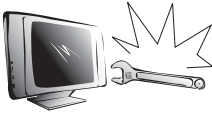

Dangerous high-voltage electric power components are located inside the TV. To avoid electric shock, do not disassemble the TV in any way.



Do not place or drop metals, small objects, or flammable materials into the vent of the TV.



If the TV is dropped, falls down, or is otherwise damaged, unplug the power cord immediately and contact an authorized service technician.



If any fluid is sprayed or dropped into the TV, contact an authorized service technician.



The screen of the TV is made of glass. Avoid hitting or scraping it. If the screen is broken, do not touch the broken glass.



Do not allow children to use the TV unattended.

Installation

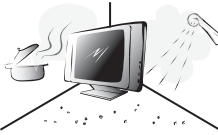

Do not place the TV in locations where there is excessive steam or dust.



Avoid blocking the TV's vents, do not place the TV on a bed, sofa, carpet, or in a sealed cabinet.

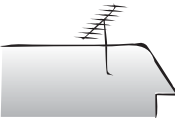

Install the outdoor antenna (not included) away from power transmission lines to avoid possible danger.



Unplug the power cord and antenna connector when there is a storm or when the TV is not in use for long periods to avoid electric shock from lightning.

Operation



This TV is designed for home power sources as labeled on the casing. Avoid using any other power accessories to avoid electric shock or other damage.



The plug can be inserted into an outlet in only one direction as shown to the left. Do not alter the plug. Contact an authorized service technician if you cannot plug it in correctly.



If there is any problem that cannot be resolved according to the instructions given in this manual, contact an authorized service technician immediately. Do not attempt any methods not covered in this manual.

Maintenance



Do not attempt to repair the TV by yourself. Contact an authorized service technician. Ask the service technician to complete a safety inspection before switching the power on after completing any maintenance.

Thank you for purchasing a Hannspree Liquid Crystal Display Television (LCD TV). Your new TV will allow you to enjoy superior audio and video while enriching your lifestyle with advanced technology.

Please carefully read this manual in its entirety before setting up, using or operating your TV. To ensure the safe and correct installation and operations of the TV, it is important that the safety and operation instructions in this manual are followed.

This instruction manual is designed to assist you in setting up and using the TV. The information in this manual has been carefully checked for accuracy; however, no guarantee is given to the correctness of the contents. The information in this manual is subject to change without notice.

To the extent allowed by applicable law, Hannspree California, Inc. (“Hannspree”) shall not be liable for direct, indirect, special, exemplary, incidental or consequential damages arising from any defect or omission in this manual, even if advised of the possibility of such damages in advance.

Copyright

© Copyright 2004 Hannspree California, Inc.

All rights reserved. This manual is protected by copyright and distributed under licenses restricting its use, copying and distribution. No part of this manual may be reproduced in any form by any means without the prior written authorization of Hannspree. The TV described in this manual may include copyrighted software of Hannspree (or other third parties). Hannspree (or other third parties) preserves the exclusive rights for copyrighted software, such as the right to distribute or reproduce the copyrighted software. Accordingly, and to the extent allowed by applicable law, any copyrighted software contained in the product described herein shall not be distributed, modified, reverse engineered, or reproduced in any manner without the prior written authorization of Hannspree (or of other third parties).

The Hannspree logos presented herein are trademarks of Hannspree. All other product names, trademarks or logos mentioned herein are used for identification purpose only, and may be the trademarks or registered trademarks of their respective owners.

The purchase of the product described herein shall not be deemed to grant, either directly or by implication, estoppel or otherwise, any license under the copyrights, patents, patent applications or trademarks of Hannspree, except for the normal, non-exclusive use that arises by operation of law in the sale of a product.

Thank you for purchasing this LCD TV. Your TV is designed to be safe, versatile, and easy to use. The unique design makes it a fun addition to any room.

You can watch standard NTSC television channels and easily connect a VCR, VCD, DVD player, or a video game console to the standard Video and S-Video input ports located at the rear of the unit.

Convenient control buttons located on the TV and a handy remote control let you change channels, adjust the volume, and change display settings through an easy-to-use on-screen display menu system. The TV speakers provide full, rich stereo sound and a convenient audio output port lets you connect to an external audio system or headphones.

Features

- Built-in TV tuner
- Audio/video support:
 - Stereo audio inputs
 - Composite video input
 - S-Video input
- On-screen display (OSD) menu system
- Multi-channel Television Sounds (MTS) Stereo with SAP
- Built-in stereo speakers

6

Checking Package Contents







Make sure the following components are included in the box. Please contact Hannspree Customer Service immediately if anything is missing or damaged.

- TV
- User's manual
- Quick start guide
- Warranty and service manual
- Power cord
- Power adapter
- 4-IN-1 A/V cable
- Remote control and battery/batteries
- Mounting device (model ST04 only)
- Stop Card

Control Panel



Description	Icon	Function
Power		Turns the TV power on and off.
Mute	MUTE	Press this button to eliminate sound. Press it again or press the volume adjust buttons directly to restore sound.
Source	SOURCE	Selects the input source to be displayed (TV, AV1, or AV2). The source is displayed on the top right corner of the screen.
Menu	MENU	Turns the on-screen display (OSD) menu on and off.
Channel select	<p>the CH UP button (▲) the CH DOWN button (▼)</p>	<p>Channel up: Increases the channel number.</p> <p>Channel down: Decreases the channel number.</p> <p>These buttons are also used to navigate the OSD menus.</p>
Volume adjust	<p>the VOL UP button (+) the VOL DOWN button (-)</p>	<p>Volume up: Increases the volume.</p> <p>Volume down: Decreases the volume.</p> <p>These buttons are also used to navigate the OSD menus.</p>
Power indicator LED		Green LED indicates power on.
Remote IR Sensor		Receives signals from the remote control.

Input and Output Jacks

Description	Connector	Function
AV1 (S-VIDEO/ R/L/VIDEO)		Use the AV1 input to connect an external device, such as a VCR, VCD, or DVD player. Audio Input: AV connector audio (white and red) cables. Video Input: AV connector video (yellow) cable or S-Video cable.
AV2		Use the included 4-IN-1 A/V cable to connect external devices, such as a VCR, VCD, or DVD player. Audio Input: AV connectors audio (white and red) cables. Video Input: AV connector video (yellow) or S-Video cable.
ANT (Antenna /cable TV in)		Connects to an antenna or CATV cable.
DC-IN		Connects to the power adapter.
LINE OUT		Connects to external amplified speakers.
Headphone jack		Connects to headphones.

Remote Control

Description	Icon	Function
Menu button	MENU	Turns the on-screen display (OSD) menu on and off.
Arrow buttons	▲ / ▼ / ◀ / ▶	Press ▲, ▼, ◀ or ▶ to scroll through the on-screen display menus. You can assign 4 favorite channels to the arrow buttons. See "Using the Favorite Channel Feature" on page 31
Number buttons	1 2 3 4 5 6 7 8 9 0	Use to select a channel directly. Press 0-9 to enter the channel number (press 1 and 0 for channel 10).
Last button	LAST	Press this button to return to the last channel selected.
CC button	CC	Press this button to enable the closed captions/subtitles (only available in the United States of America). This option may not be available in your local area.
Display button	DISPLAY	Press this button to show messages on the screen, such as the channel number, MTS mode and others. Press the button again to close the displayed message. This option may not be available in your local area.

Description	Icon	Function
MTS button	MTS	(Multi-channel Television Sound) The indicator on the top right corner of the screen is yellow when the program has MAIN/SAP/MONO capabilities. Press it to enable the bilingual function.
Mute button	MUTE	Press this button to eliminate sound. Press it again or press the volume adjust buttons to restore sound.
Sleep button	SLEEP	Press this button repeatedly to set the length of time the TV remains turned on (30, 60, 90, or 120 minutes). A timer appears on the top right corner of the screen to show the time remaining. Cancel the timer by pressing until the displayed time disappears.
Power button		Turns the TV power on or off.
Volume adjust buttons	-VOL VOL+	Volume up: Increases the volume. Volume down: Decreases the volume.
Channel select buttons	CH   CH	Channel up: Increases the channel number. Channel down: Decreases the channel number.
Source button	SOURCE	Selects the input source to be displayed (TV, AV1, AV2). The source is displayed on the top right corner of the screen.

Inserting the Remote Control Batteries

- 1 Open the battery compartment cover at the back of the remote control (A).
- 2 **For AAA batteries:** Insert the batteries paying attention to the polarity markings inside the battery compartment (B).
For lithium batteries: Insert the battery/ batteries with the positive side (+) facing up (B). Remember to slide the battery/ batteries underneath the metal contacts. Press downward to set the battery/batteries in place.
- 3 Replace the battery compartment cover (C)/(D).

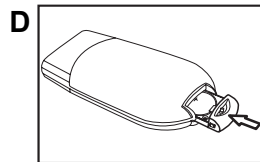
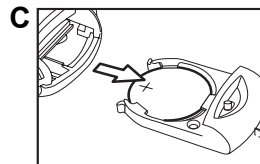
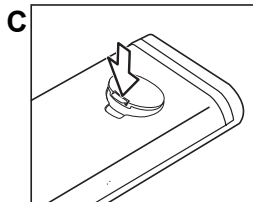
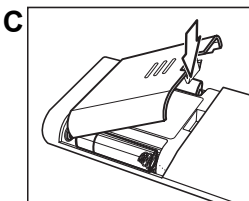
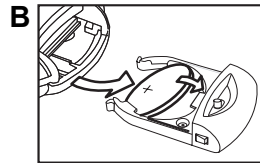
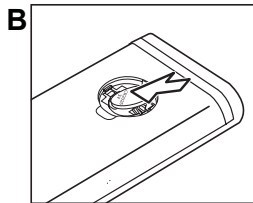
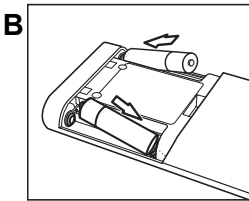
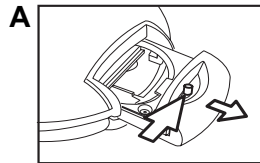
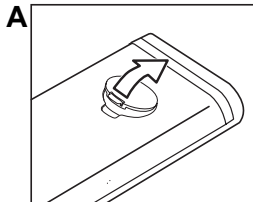
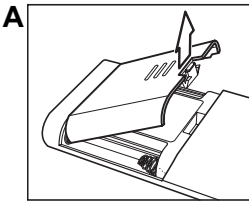

AAA batteries

Lithium batteries 1

Lithium batteries 2

Note

Your remote control may have either two AAA type batteries or lithium (CR2025) battery/batteries.

CAUTION



- If the remote control is not used for a long period, remove the batteries and store them separately.
- Handle damaged or leaking batteries carefully, and wash hands after such handling.
- Refer to your local recycling or waste disposal rules and contact a local waste disposal vendor to dispose of used batteries.
- If your remote control has two batteries, do not mix new and old batteries because the life of the new batteries will be shortened. Chemical fluids may leak from the old batteries.
- Danger of explosion if battery is incorrectly replaced. Replace only with the same or equivalent type recommended by the equipment manufacturer. Discard used batteries according to manufacturer's instructions.
- Your remote control may have a magnet in it, so do not place magnetic sensitive items such as watches, credit cards, or flash media close to it.

Making Connections

Connecting to an Antenna or Cable TV

- 1 Connect one end of the VHF/UHF (Antenna) or CATV cable to the ANT Jack (VHF/UHF IN Jack) on the back of the TV.
- 2 Connect the other end of the VHF/UHF (Antenna) or CATV cable to the antenna socket or CATV cable.

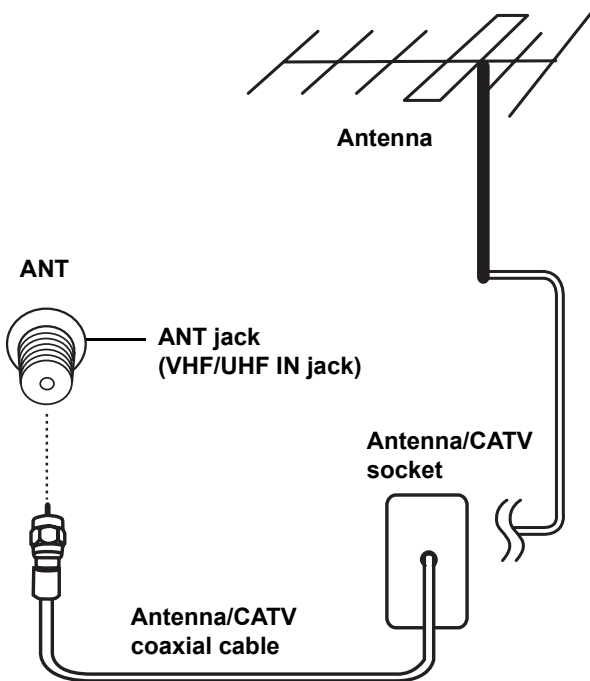

Note

If you cannot receive channels after connecting to an antenna or cable TV line, try scanning for channels. See "Auto Program" on page 52.

Connecting to AV Devices

Connect external devices such as VCR, VCD, DVD players, or a video game console to the TV using the AV1 or AV2 ports on the back of the TV using the supplied 4-IN-1 A/V cable.

Connecting to a VCR, VCD or DVD Player

The illustration presented here shows you how to connect your TV to a VCR, VCD or DVD player. Actual connections may vary according to the make and model of your device. Refer to the user's manual included with the AV device for more detailed instructions.

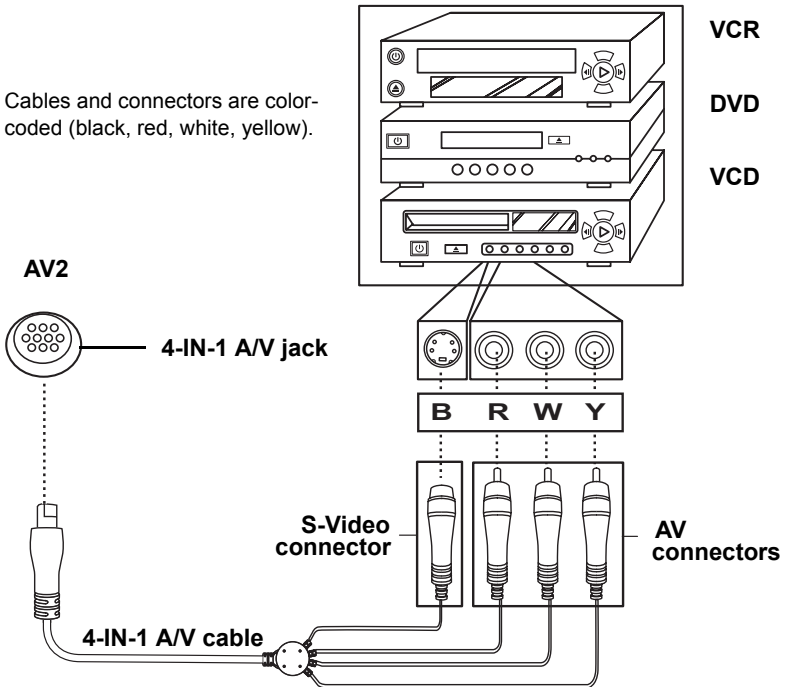

Note

When connecting the S-Video connector and AV connectors at the same time, the priority is given to the S-Video connector.

Connecting to a Video Camera

The following illustration shows you how to connect the TV to a camcorder. Actual connections may vary according to the make and model of the device. Refer to the user's manual included with the camcorder for more detailed instructions.

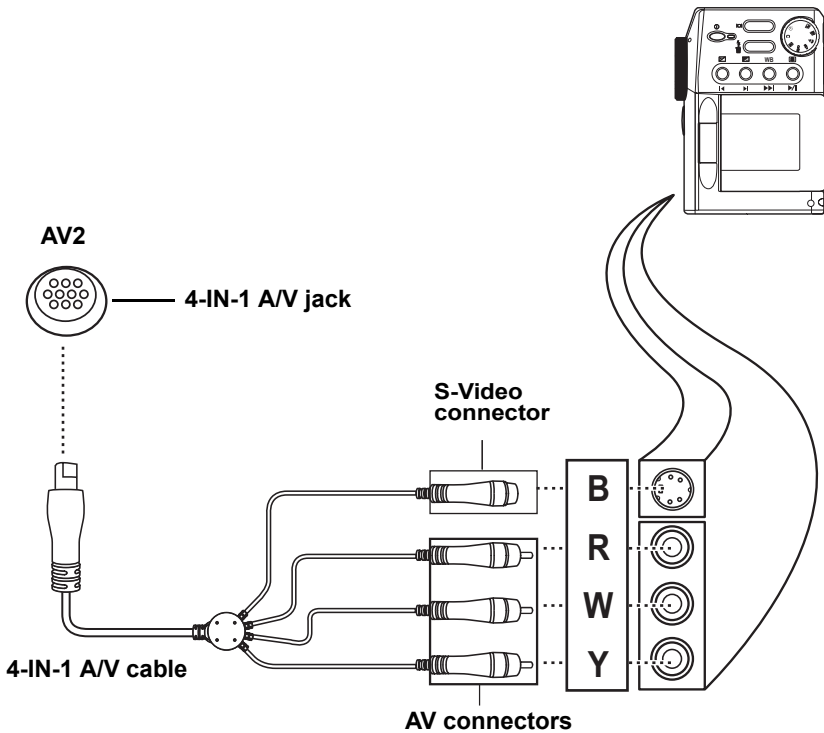

Connecting to a Video Game Console

The instructions presented here are a general guide to connecting the TV to a game console using the RCA Jacks (some game devices may require a unique adapter that is not provided). Actual connections may vary according to the make and model of the game device. Refer to the user's manual included with the game console for more detailed instructions.

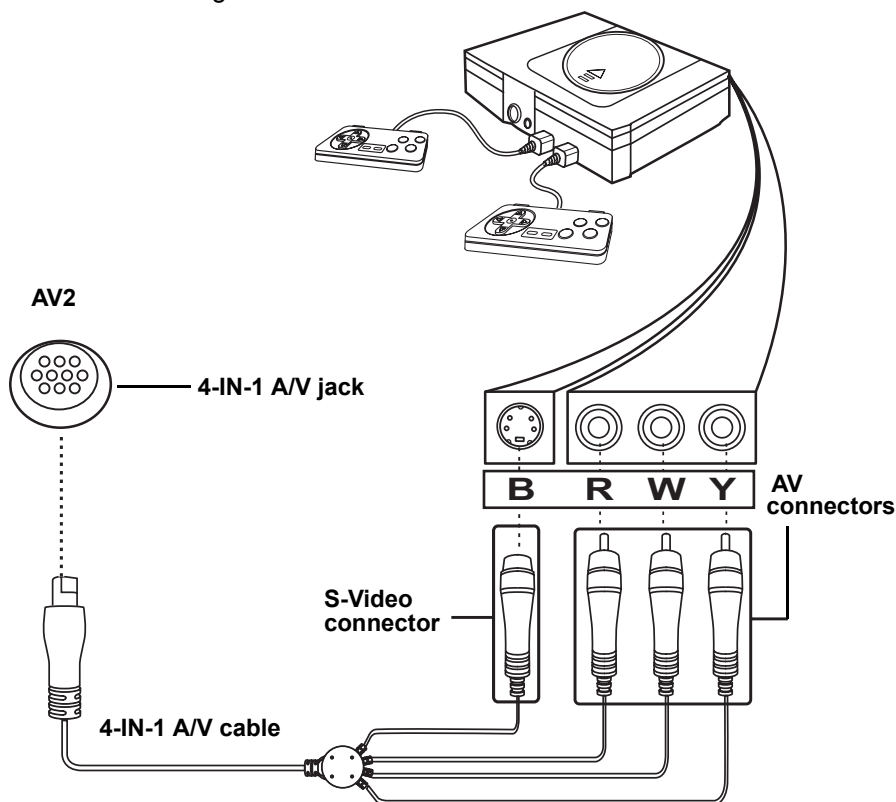

Notes

- Connect the 4-IN-1 A/V cable connectors to the corresponding connectors on your game device adapter.
- If the 4-IN-1 A/V cable does not fit the game device, then insert RCA jack between the 4-IN-1 A/V cable and game device.

Connecting Headphones

Headphones may be used to listen to the TV instead of using the built-in speakers. Connect headphones to the headphone line out port as illustrated.



Notes

- Headphones are not included with the product.
- The built-in TV speakers will not output sound when headphones are plugged in.

Connecting an Amplifier or Speakers (Built-in amplifier)

Connect an external amplifier or speakers to the line out port to provide better sound quality. Refer to the following illustration.

LINE OUT

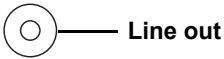

Speakers
(Built-in amplifier)

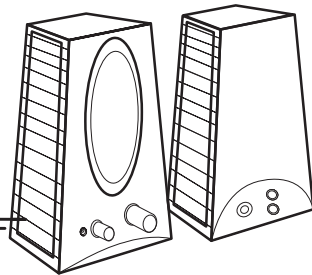

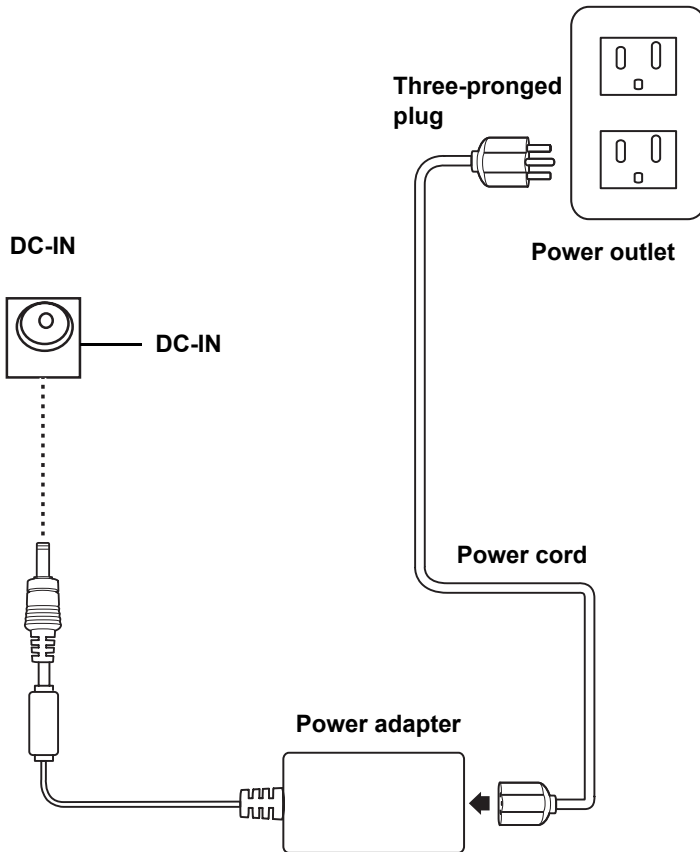

Connecting the Power Adapter

- 1 Connect the power cord to the power adapter as illustrated.
- 2 Plug the power adapter connector into the DC-IN on the rear panel of the TV.
- 3 Plug the three-pronged plug at the other end of the power cord into a power outlet.



Turning the TV On and Off

- 1 Press the **POWER**  button on the remote control or on the TV control panel. The power indicator LED on the front of the TV changes from red to green, indicating that the power is on.
- 2 Press the **POWER**  button again. The power indicator LED changes from green to red, indicating that the TV is off.

Switching Source Signals

Press the **SOURCE** button to select different source signals.

CH, AV1, and AV2 appear on the top right corner of the screen in that order.

Adjusting the Volume

- 1 Press the **VOL UP** button on the remote control or on the TV control panel to increase the volume.
- 2 Press the **VOL DOWN** button to decrease the volume.
- 3 Press the **MUTE** button on the remote control. The word “MUTE” appears on the top right corner of the screen and sound is turned off.
- 4 Press the **MUTE** button again to restore the original volume.

Selecting Channels

- 1 Press the **CH UP** button to increase the channel number by one.
- 2 Press the **CH DOWN** button to decrease the channel number by one.
- 3 Enter the specific channel number by pressing the number buttons on the remote control. The channel is displayed on the screen.

Using the Remote Control

Aim the transmitter on the remote control at the remote IR sensor of the TV and ensure that there are no obstacles between them. The operational distance may be shortened when the remote IR sensor is directly exposed to strong light.

For best results, use the remote control within a distance of 16 feet (5 meters) from the front of the TV. Do not exceed an angle of 30 degrees when pointing at the TV.

Using the Favorite Channel Feature

Setting:

- 1 Enter a favorite channel number with the remote control.
- 2 Press and hold an arrow button for at least 3 seconds, then release the button.
- 3 A “suffix number”, which corresponds to the arrow buttons as **▲** →(1), **▶** →(2), **▼** →(3), **◀** →(4), will appear (at the right corner of the channel number) indicating that your “favorite channel button” is set correctly. See the illustration below.

CH **15**₁
MAIN SAP MONO

- 4 Select the next arrow button that you wish to set up or change and repeat steps 1 to 3 until all the buttons are set.
- 5 After all four arrow buttons are set to your favorite channels, you may recall a channel by pressing the corresponding arrow button.

MTS



Press the **MTS** button on the remote control. The MTS menu appears on the screen with the current setting flashing.



MAIN

Press the **MTS** button to select MAIN. This is the audio signal belonging to a particular channel.



SAP

Press the **MTS** button to select SAP. This enables the secondary audio program.



MONO

Press the **MTS** button to select MONO. This enables the mono audio signal.

Note

MTS availability is dependent on your television service provider. The indicator on the screen is yellow when the program has MAIN/SAP/MONO capabilities.

10

Adjusting On-Screen Display (OSD) Settings

The On-Screen Display (OSD) menu system provides a quick and simple method to adjust your TV's settings. This chapter describes how to change each of the available settings with the control panel.

Button Descriptions (Control Panel)	Icons	Button Descriptions (Remote Control)	Icons
Menu	(MENU)	Menu	(MENU)
CH up	(▲)	Up arrow	(▲)
CH down	(▼)	Down arrow	(▼)
VOL up	(+)	Right arrow	(▶)
VOL down	(-)	Left arrow	(◀)

The OSD can be used with either the control panel or remote control.

OSD Setting Menus

Press the **MENU** button to enter the OSD menus.
The Main Menu appears.

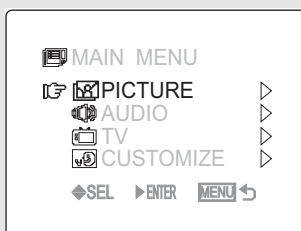

Note

Press the **MENU** button to exit the OSD menus and submenus at any time. Repeatedly press the **MENU** button to exit the OSD menus and sub-menus and return to TV mode.

Picture Setting

Press the **MENU** button to enter the OSD menus.
Press the **VOL UP** button to enter the PICTURE Menu.

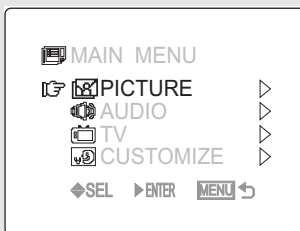

Note

You can operate the OSD with either the remote control or the control panel.

Brightness



- 1** Press the **VOL UP** button. The brightness slide bar appears.
- 2** Press the **VOL UP** button to increase the brightness.
- 3** Press the **VOL DOWN** button to decrease the brightness.
- 4** Press the **MENU** button to confirm the setting and return to the Picture Menu.

Note

The new setting is confirmed automatically when the OSD times out.

	MAX	MID	MIN
BRIGHTNESS	+12	0	-12

Contrast

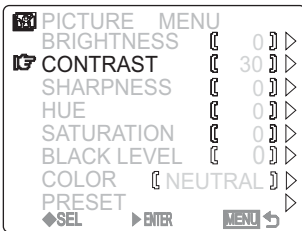

- 1 Press the **CH DOWN** button to select **CONTRAST**.
- 2 Press the **VOL UP** button. The contrast slide bar appears.
- 3 Press the **VOL UP** button to increase the contrast.
- 4 Press the **VOL DOWN** button to decrease the contrast.
- 5 Press the **MENU** button to confirm the setting and return to the Picture Menu.

Note

The new setting is confirmed automatically when the OSD times out.

	MAX	MID	MIN
CONTRAST	30	15	1

Sharpness



- 1 Press the **CH DOWN** button to select SHARPNESS.
- 2 Press the **VOL UP** button. The sharpness slide bar appears.
- 3 Press the **VOL UP** button to increase the sharpness.
- 4 Press the **VOL DOWN** button to decrease the sharpness.
- 5 Press the **MENU** button to confirm the setting and return to the Picture Menu.

Note

The new setting is confirmed automatically when the OSD times out.

	MAX	MID	MIN
SHARPNESS	+8	0	-8

Hue



- 1 Press the **CH DOWN** button to select HUE.
- 2 Press the **VOL UP** button. The hue slide bar appears.
- 3 Press the **VOL UP** button to increase the hue toward the green end of the spectrum. The image becomes more green.
- 4 Press the **VOL DOWN** button to decrease the hue toward the red end of the spectrum. The image becomes more red.
- 5 Press the **MENU** button to confirm the setting and return to the Picture Menu.

Note

The new setting is confirmed automatically when the OSD times out.

	MAX	MID	MIN
HUE	+24	0	-24

Saturation

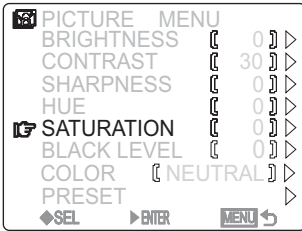

- 1 Press the **CH DOWN** button to select SATURATION.
- 2 Press the **VOL UP** button. The saturation slide bar appears.
- 3 Press the **VOL UP** button to increase the saturation.
- 4 Press the **VOL DOWN** button to decrease the saturation.
- 5 Press the **MENU** button to confirm the setting and return to the Picture Menu.

Note

The new setting is confirmed automatically when the OSD times out.

	MAX	MID	MIN
SATURATION	+24	0	-24

Black Level

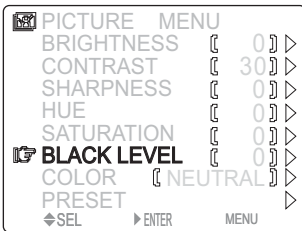

- 1 Press the **CH DOWN** button to select **BLACK LEVEL**.
- 2 Press the **VOL UP** button. The black level slide bar appears.
- 3 Press the **VOL UP** button to increase the black level.
- 4 Press the **VOL DOWN** button to decrease the black level.
- 5 Press the **MENU** button to confirm the setting and return to the Picture Menu.

Note

The new setting is confirmed automatically when the OSD times out.

	MAX	MID	MIN
BLACK LEVEL	+24	0	-24

Color



- 1 Press the **CH DOWN** button to select **COLOR**.
- 2 Press the **VOL UP** button. The current setting appears blinking in the brackets.

Neutral Color

Press the **VOL UP** button to select **NEUTRAL**, then press the **MENU** button. “NEUTRAL” appears in the brackets.

Warm Color

Press the **VOL UP** button to select **WARM**, then press the **MENU** button. “WARM” appears in the brackets.

Cold Color

Press the **VOL UP** button to select **COLD**, then press the **MENU** button. “COLD” appears in the brackets.

Note
The default color temperature is **NEUTRAL**.

Preset



- 1 Press the **CH DOWN** button to select PRESET.
- 2 Press the **VOL UP** button. "OK" appears in the brackets. All picture settings are returned to the factory-set default values.

Note
The preset function erases all of your custom picture settings.

Audio Setting

Press the **MENU** button to enter the OSD Main Menu screen.

- 1** Press the **CH UP / CH DOWN** button to select **AUDIO**.
- 2** Press the **VOL UP** button to enter the Audio Menu.

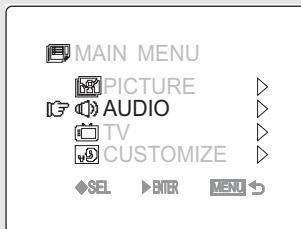

Note

You can operate the OSD with either the remote control or the control panel.

Treble

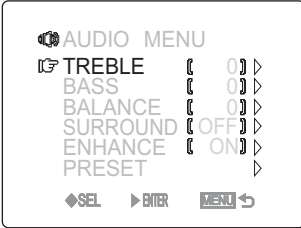

- 1 Press the **VOL UP** button. The treble slide bar appears.
- 2 Press the **VOL UP** button to increase the treble.
- 3 Press the **VOL DOWN** button to decrease the treble.
- 4 Press the **MENU** button to confirm the setting and return to the Audio Menu.

Note

The new setting is confirmed automatically when the OSD times out.

	MAX	MID	MIN
TREBLE	+24	0	-24

Bass

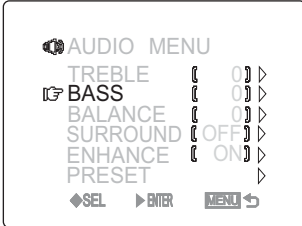

- 1 Press the **CH UP** button to select BASS.
- 2 Press the **VOL UP** button. The bass slide bar appears.
- 3 Press the **VOL UP** button to increase the bass.
- 4 Press the **VOL DOWN** button to decrease the bass.
- 5 Press the **MENU** button to confirm the setting and return to the Audio Menu.

Note

The new setting is confirmed automatically when the OSD times out.

	MAX	MID	MIN
BASS	+24	0	-24

Balance



- 1 Press the **CH DOWN** button to select BALANCE.
- 2 Press the **VOL UP** button. The balance slide bar appears.
- 3 Press the **VOL DOWN** button to shift the balance to the left speaker.
- 4 Press the **VOL UP** button to shift the balance to the right speaker.
- 5 Press the **MENU** button to confirm the setting and return to the Audio Menu.

Note

The new setting is confirmed automatically when the OSD times out.

	LEFT	MID	RIGHT
BALANCE	-24	0	+24

Surround

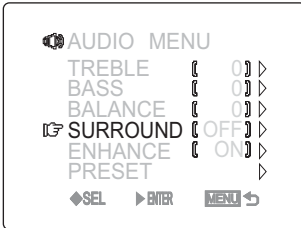

- 1 Press the **CH DOWN** button to select SURROUND.
- 2 Press the **VOL UP** button to enter the setting field.
- 3 Press the **VOL UP** button to turn surround on or off.
- 4 Press the **MENU** button to confirm your choice.

Enhance



- 1 Press the **CH DOWN** button to select ENHANCE.
- 2 Press the **VOL UP** button to enter the setting field.
- 3 Press the **VOL UP** button to turn enhance on or off.
- 4 Press the **MENU** button to confirm your choice.

Preset

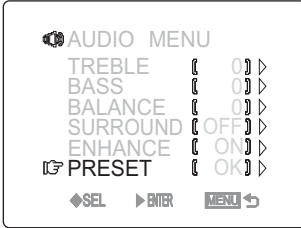

- 1 Press the **CH UP** button to select PRESET.
- 2 Press the **VOL UP** button. “OK” appears in the brackets. All audio settings are returned to the factory-set default values.

Note
The preset function erases all of your custom audio settings.

TV Setting

Press the **MENU** button to enter the OSD Main Menu screen.

- 1** Press the **CH UP / CH DOWN** button to select TV.
- 2** Press the **VOL UP** button to enter the TV Menu.

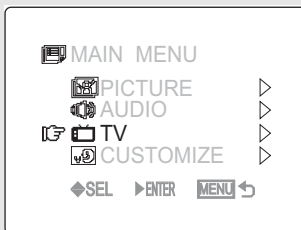

Note

You can operate the OSD with either the remote control or the control panel.

TV/CATV

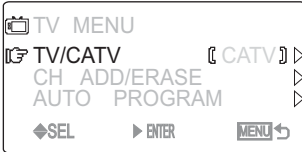

- 1 Press the **VOL UP** button. The current setting appears flashing in the brackets.

Receiving Cable TV

Press the **VOL UP** button to select CATV, then press the **MENU** button. "CATV" appears in the brackets.

Receiving Broadcast TV

Press the **VOL UP** button to select TV, then press the **MENU** button. "TV" appears in the brackets.

Channel Add/Erase

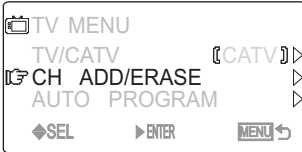

- 1 Press the **CH DOWN** button to select CH ADD/ERASE.
- 2 Press the **VOL UP** button. The OSD menu display switches to the following screen.
- 3 Press the **CH UP/CH DOWN** button on the front panel to select a channel.

Add Channel

Then press the **VOL UP** button on the front panel to add the selected channel. The channel number changes from yellow into green after adding the channel.

Erase Channel

Then press the **VOL DOWN** button on the front panel to erase the selected channel. The channel number changes from green into yellow after erasing the channel.

Note

You can still access the erased channel by entering the channel number using the number buttons on the remote control. Use the Add Channel steps if the channel was erased accidentally.

Auto Program

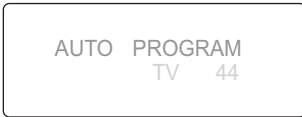
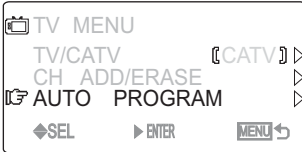

- 1** Press the **CH DOWN** button to select **AUTO PROGRAM**.
- 2** Press the **VOL UP** button to begin auto programming. The screen displays channels incrementally as the TV scans for available channels.

Note
The screen displays the first channel that is successfully found after scanning is completed.

Customize Setting

Press the **MENU** button to enter the OSD Main Menu screen.

- 1** Press the **CH UP / CH DOWN** button to select CUSTOMIZE.
- 2** Press the **VOL UP** button to enter the Customize Menu.

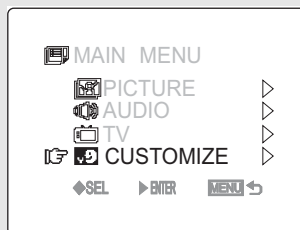

Note

You can operate the OSD with either the remote control or the control panel.

Sleep Timer

The sleep timer turns the TV off automatically after a set time.



- 1** Press the **VOL UP** button to select a value: OFF, 30, 60, 90, or 120 minutes.
- 2** Press the **MENU** button to confirm your choice.

You can also press the **SLEEP** button on the remote control to select 30, 60, 90 or 120 minutes. The setting appears on the TV screen.

The remaining time is updated on the display every 10 minutes. During the last minute, the sleep timer flashes.

OSD Timeout

This setting allows you to set the length of time the OSD menus appear on the screen when a button is not pressed.

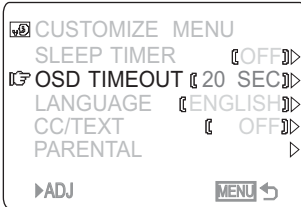

- 1 Press the **CH DOWN** button to select OSD TIMEOUT.
- 2 Press the **VOL UP** button. The current setting appears flashing in the brackets.
- 3 Press the **VOL UP** button to select a value: 20, 40, or 60 seconds.
- 4 Press the **MENU** button to confirm your choice.

Language

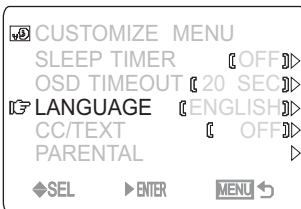

- 1 Press the **CH DOWN** button to select LANGUAGE.
- 2 Press the **VOL UP** button. The current setting appears flashing in the brackets.
- 3 Press the **VOL UP** button to select the desired language.
- 4 Press the **MENU** button to confirm your choice.

CC/TEXT (Closed Caption)

This setting allows you to select closed caption subtitles or text information broadcast with the program.¹

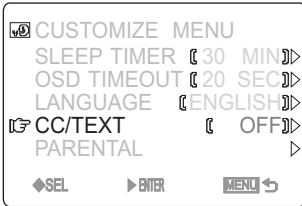

- 1** Press the **CH DOWN** button to select CC/TEXT.
- 2** Press the **VOL UP** button. The current setting appears flashing in the brackets.
- 3** Press the **VOL UP** button to select CC1, CC2, CC3, CC4, TEXT1, TEXT2, TEXT3, TEXT4, or OFF.
- 4** Press the **MENU** button to confirm your choice.

Note
CC1 ~ CC4 settings display a text version of the dialogue or sound effects.
TEXT1 ~ TEXT4 settings display network information in either half or all of the screen.

1. Closed Caption is only available in the United States of America. This option may not be available in your local area.

Parental

The Parental Control Function (V-CHIP) is used to block program viewing based on the ratings sent by the broadcast stations.¹ The United States has two rating systems for viewing contents, i.e. TV Parental Guidelines and movie ratings. The TV Parental Guidelines work in conjunction with the V-CHIP to help parents screen out inappropriate television programs from their children. Movie ratings are used for original movies rated by the Motion Picture Association of America (MPAA) as watched on cable TV and not edited for television. The V-CHIP can also be set to block MPAA-rated movies.

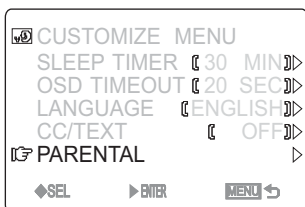

ENTER PASSWORD

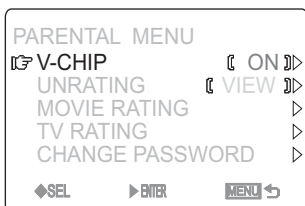

1 Press the **CH DOWN** button to select PARENTAL.

2 Press the **VOL UP** button. The password screen appears.

The parental control settings can ONLY be changed using the remote control. It is not possible to make any changes using the front panel buttons.

3 Enter the password to the PARENTAL menu.

Note
To use the Parental Control Function, a password must be set. The default password is 0000. If the password entered is wrong, the message **WRONG PASSWORD** is displayed and you can try again. Please refer to page 62 for Change Password.

1. Parental functions are only available in the United States of America and contingent upon the availability of the TV network programming.

MPAA Ratings

- G** – Suitable for a general audience, all children
- PG** – Parental guidance suggested
- PG-13** – Parental guidance for children under 13 suggested
- R** – Restricted viewing. Parental guidance suggested for children under 17
- NC-17** – No-one under 17 allowed to view
- X** – Adults only

TV Ratings

Age based

- TV-Y** – Suitable for a general audience, all children
- TV-Y7** – Directed at children aged 7 and older
- TV-G** – General audience
- TV-PG** – Parental guidance suggested
- TV-14** – Parents strongly cautioned
- TV-MA** – Mature audience only

Content based

- FV** – Fantasy violence
- D** – Suggestive dialogue
- L** – Strong language
- S** – Sexual situations
- V** – Violence

Note

More information about the ratings systems can be found by visiting the these Web sites.

<http://www.mpa.org>

<http://www.tvguidelines.org>

V-chip

This setting allows you to turn the V-chip functions on or off.

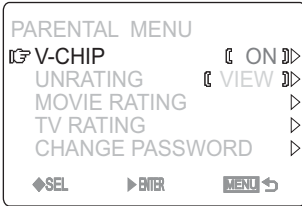

- 1 Press the ► button. The current setting appears flashing in the brackets.
- 2 Press the ► button to select ON or OFF.
- 3 Press the **MENU** button to confirm your choice.

Unrating

This setting allows you to define whether or not to block broadcasts that are not rated.

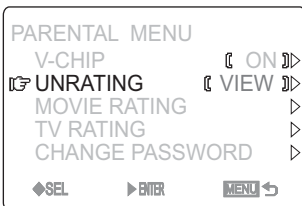

- 1 Press the ▼ button to select UNRATING.
- 2 Press the ► button. The current setting appears flashing in the brackets.
- 3 Press the ► button to select VIEW or BLOCK.
- 4 Press the **MENU** button to confirm your choice.

Movie Rating

This setting allows you to define which movie ratings are blocked.

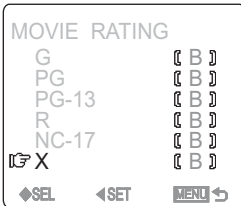
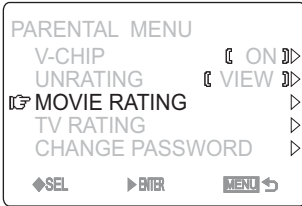

- 1 Press the ▼ button to select MOVIE RATING.
- 2 Press the ► button. The MOVIE RATING menu appears.
- 3 Press the ▼ button to select a rating to define.
- 4 Press the ◀ button to block [B] and unblock [U].
- 5 Press the **MENU** button to confirm your choice.

Note

When a rating is changed, all ratings that apply to children younger than those covered in that rating, are also changed.

TV Rating

This setting allows you to define which TV ratings are blocked.

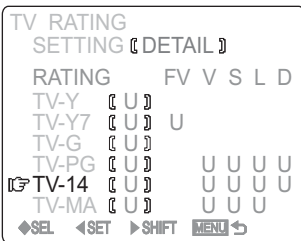
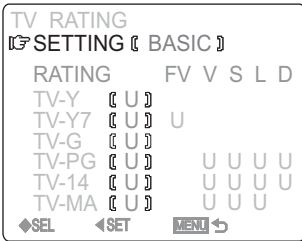
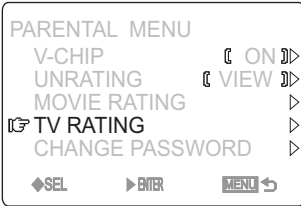

- 1 Press the ▼ button to select TV RATING.
- 2 Press the ► button. The TV RATING menu appears.
- 3 Press the ▼ button to select SETTING.
- 4 Press the ◀ button to choose BASIC or DETAIL.
In DETAIL mode you can select individual categories to block within some ratings.
- 5 Press the ▼ and ► button to select a rating or category to define.
- 6 Press the ◀ button to block [B] and unblock [U].
- 7 Press the MENU button to confirm your choice.

Note
When a rating is changed, all ratings that apply to children younger than those covered in that rating, will also be changed.

Change Password

This setting allows you to change the password needed to access the parental control features.

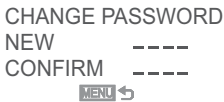
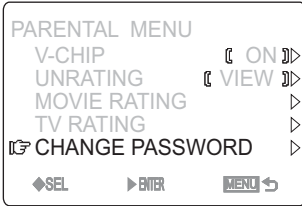

- 1 Press the ▼ button to select CHANGE PASSWORD. Then press the ► button. The CHANGE PASSWORD screen appears.
- 2 Use the remote control to type in a new password.
- 3 Type in the new password a second time to confirm.

Notes

- If both the passwords match, the message **PASSWORD SUCCESS** appears. If the two passwords don't match, the message **PASSWORD FAILURE** appears.
- Your password is required to access any parental control features in the future. If you forget your password, see "Troubleshooting" on page 64.

11

Taking Care of Your TV & Remote Control



Turn the power off before you begin cleaning the TV.



For best results, use a clean lens cloth to remove dust and fingerprints from the screen.



Do not wipe the shell of the TV with alcohol, methanol, gasoline or oil products to avoid damaging the finish. Wipe the shell with a dry soft cloth and use neutral cleaning fluids.



If your model has leather components, wipe the leather parts with a dry cloth and keep the area dry. Place the TV far from sources of steam to avoid making the leather wet.



Be careful to disconnect the power plug correctly. Hold the plug. Do not attempt to disconnect the plug by pulling on the power cord.

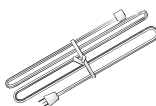

Arrange and store the power cord neatly as shown to the left to avoid knotting or bending which may cause fire due to damage or electric leakage.

Notes

- **Do not place the remote control in hot or humid locations. Protect the remote control from shock or vibration to avoid damages.**
- **Check the remote control batteries on a regular basis. Clean any stains on the rear battery cover immediately and use new batteries if fluid is leaking from old batteries.**

Situation	Solution
No picture and sound.	<ul style="list-style-type: none"> • Connect the power cord properly. • Press the POWER button on the control panel or remote control. • Press the SOURCE button to cycle through connected video sources. • Press the CH UP or CH DOWN button to switch to other TV stations. • Check the TV/CATV OSD settings. See “Taking Care of Your TV & Remote Control” on page 63. • Make sure all cables are connected properly.
No picture, or poor picture, sound is OK.	<ul style="list-style-type: none"> • Check the antenna and cable connections. • Adjust the brightness in the OSD menus. See “Brightness” on page 35.
Picture is not in color.	<ul style="list-style-type: none"> • Adjust the saturation in the OSD menus. See “Saturation” on page 39. • Make sure all cables are connected properly.
Picture is OK, no sound.	<ul style="list-style-type: none"> • Make sure the source device is functioning properly. • Make sure the audio cable is connected securely. • Turn the mute off. • Press the VOL UP button on the control panel or remote control. • Make sure the MTS option is set to MAIN or MONO.
One of the speakers has no sound.	<ul style="list-style-type: none"> • Adjust the balance in the OSD menus. See “Balance” on page 46. • Make sure the audio cables are connected securely.
Cannot receive some TV channels using cable TV.	<ul style="list-style-type: none"> • Try the Auto Program function in the OSD “TV Setting” menu. See “Auto Program” on page 52.
Want to reset TV settings.	<ul style="list-style-type: none"> • Use the Preset function in the OSD Picture and Audio menu.

Situation	Solution
Cannot operate menus.	<ul style="list-style-type: none"> If OSD items are colored light blue, the system is in a state such that those settings are not available. For example, video setting is available in TV mode.
Remote control doesn't work.	<ul style="list-style-type: none"> Make sure the battery is inserted correctly. Replace the battery with a new one. Make sure the TV power cord is plugged in. Make sure the path between the remote control and the sensor is clear. Try operating the remote control at a closer distance to the TV. Refer to "Using the Remote Control" on page 31 for more information.
Screen image turns over.	<ul style="list-style-type: none"> Make sure the video signal cable is connected properly.
Snow appears on the screen.	<ul style="list-style-type: none"> Adjust the location of the antenna, placing it far from roads or sources of interference. Check the antenna and the video signal line connections.
Blurred or overlapped images.	<ul style="list-style-type: none"> Readjust the sharpness setting. Choose programs with high quality signals. Adjust the direction of the antenna or change the video signal cable.
Forgot parental control password	<ul style="list-style-type: none"> Use the master password 0928

For complete warranty service information, please refer to the “Warranty and Service Manual” enclosed with your TV.

15-inch LCD TV	
LCD Panel Size	15-inch TFT
Aspect Ratio	4:3
Display Resolution	1024 (horizontal) x 768 (vertical)
Maximum Display Area	304.1 mm (H) x 228.1mm (V)
TV System	NTSC
Video System	AV1: Composite Video (RCA jack) + S-Video AV2: 4-IN-1 A/V cable (Composite) + S-Video
Audio System	AV1: L/R RCA jacks AV2: 4-IN-1 A/V cable L/R RCA jacks 3.5 mm headphone port (audio output)
Built-in stereo speakers	2W + 2W
Power Supply	100~240V, 50/60 Hz, 12V DC
Power Consumption	42W (Max.)

Aspect Ratio: The ratio of width to height of a film, image or display screen.

Broadcast TV: Broadcasting video signals using high-frequency electromagnetic waves to distribute television channels to viewers (standard TV broadcast).

CATV: Community Antenna Television, the original name for cable TV. A television distribution system that uses coaxial cable instead of the traditional radio broadcasting (over-the-air) method to deliver television, FM radio, and other services to consumers.

Color Temperature: Adjusting the color temperature enables you to set the intensity of white light. Color temperature is measured in Kelvin (K). Higher color temperatures result in a blue tint. Lower temperatures result in a red tint.

Hue: Colors in a color system are measured by hue, saturation and luminance. Hue indicates the predominant color.

LCD (Liquid Crystal Display): A display technology that uses rod-shaped molecules (liquid crystals) that flow like liquid and bend light.

MTS: Multi-channel Television Sound. Enables reception of audio other than the primary (stereo) audio signal. SAP (Second Audio Program) enables reception of a separate channel that may be a different language or completely different information such as the news.

OSD (On-Screen Display): A control panel on the television screen that allows you to select viewing options.

Saturation: Chromatic purity indicating the amount of white contained in a color. Fully saturated colors are pure colors; less saturated colors appear as pastel shades.

Stereo: is the default audio signal belonging to a particular channel.

S-Video: Separate video, a video cabling standard used to transmit video by keeping brightness (Y) and color information (C) on separate channels. Most often used with camcorders, VCRs, and quality receivers and amplifiers to provide sharper pictures.