

# OWNER'S MANUAL

## 20" REAR DISCHARGE ROTARY MOWER

Model Numbers  
112-310A  
112-310-300

**Important:**  
Read Safety Rules and  
Instructions Carefully

Thank you for purchasing an  
American built product.

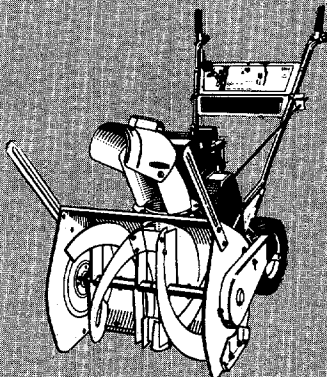
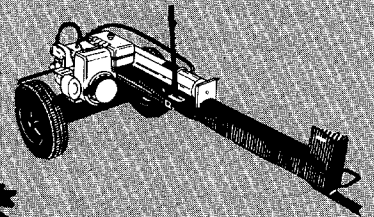
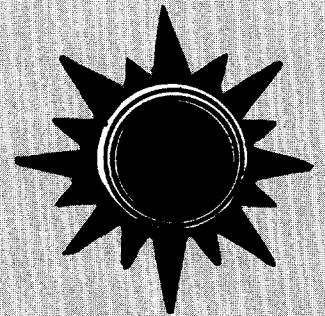
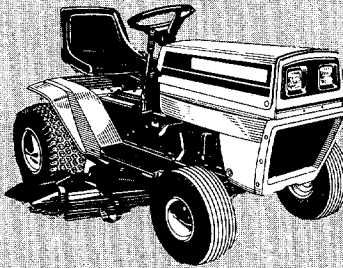
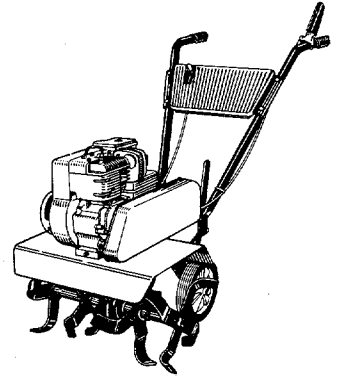

# INDEX

Safe Operation Practices .....	3	Maintenance .....	9
Assembly .....	4	Off-Season Storage .....	10
Operation .....	7	Illustrated Parts .....	12
Adjustments .....	8	Repair Parts List .....	13
Lubrication .....	9	Parts Information .....	Back Cover

## LIMITED WARRANTY

For one year from the date of original retail purchase, MTD PRODUCTS INC will either repair or replace, at its option, free of charge, F.O.B. factory or authorized service firm, any part or parts found to be defective in material or workmanship. Transportation charges for the movement of any power equipment unit or attachment are the responsibility of the purchaser. Transportation charges for any parts submitted for replacement under this warranty must be paid by the purchaser unless such return is requested by MTD PRODUCTS INC.

This warranty will not apply to any part which has become inoperative due to misuse, excessive use, accident, neglect, improper maintenance, alterations, or unless the unit has been operated and maintained in accordance with the instructions furnished. This warranty does not apply to the engine, motor, battery, battery charger or component parts thereof. Please refer to the applicable manufacturer's warranty on these items.

This warranty will not apply where the unit has been used commercially.

Warranty service is available through your local authorized service dealer or distributor. If you do not know the dealer or distributor in your area, please write to the Customer Service Department of MTD.

The return of a complete unit will not be accepted by the factory unless prior written permission has been extended by MTD.

This warranty gives you specific legal rights. You may also have other rights which vary from state to state.



**WARNING**

### TO PURCHASERS OF INTERNAL COMBUSTION ENGINE EQUIPPED MACHINERY OR DEVICES IN THE STATE OF CALIFORNIA

The equipment which you have just purchased does not have a spark arrester. If this equipment is used on any forest covered land, brush covered land, or grass covered unimproved land in the State of California, before using on such land, the California law requires that a spark arrester be provided. In addition, spark arrester is required by law to be in effective working order. The spark arrester must be attached to the exhaust system and comply with Section 4442 of the California Public Resources Code.



**WARNING**

To reduce the potential for any injury, comply with the following safety instructions. Failure to comply with the instructions may result in personal injury.

## SAFE OPERATION PRACTICES FOR WALK-BEHIND MOWERS

### TRAINING

1. It is suggested that this manual be read in its entirety before attempting to assemble or operate this unit. Keep this manual in a safe place for future reference and for ordering replacement parts.
2. Your rotary mower is a precision piece of power equipment, not a plaything. Therefore, exercise extreme caution at all times.
3. Read this Owner's Manual carefully. Be thoroughly familiar with the controls and the proper use of the equipment.
4. Never allow children to operate a power mower. Only persons well acquainted with these rules of safe operation should be allowed to use your mower.
5. Keep the area of operation clear of all persons, particularly small children and pets. Stop engine when they are in the vicinity of your mower. Although the area of operation should be completely cleared of foreign objects, a small object may have been overlooked and could be accidentally thrown by the mower in any direction and cause injury.

### PREPARATION

1. Thoroughly inspect the area where the equipment is to be used. Remove all stones, sticks, wire, bones and other foreign objects which could be picked up and thrown by the mower in any direction and cause injury.
2. Do not operate equipment when barefoot or wearing open sandals. Always wear substantial footwear.
3. Do not wear loose fitting clothing that could get caught on the mower.
4. Check the fuel before starting the engine. Gasoline is an extremely flammable fuel. Do not fill the gasoline tank indoors, while the engine is running, or while the engine is still hot. Wipe off any spilled gasoline before starting the engine as it may cause a fire or explosion.
5. Disengage the self-propelled mechanism or drive clutch on units so equipped before starting the engine.
6. Never attempt to make a wheel or cutting height adjustment while the engine is running.
7. Mow only in daylight or in good artificial light.
8. Never operate the equipment in wet grass. Always be sure of your footing. Keep a firm hold on the handle and walk, never run.

### OPERATION

1. Do not change the engine governor settings or overspeed the engine. Excessive engine speeds are dangerous.
2. Do not put hands or feet near or under rotating parts. Keep clear of the discharge opening at all times as the rotating blade can cause injury.
3. Stop the blade when crossing gravel drives, walks or roads.
4. After striking a foreign object, stop the

engine, remove the wire from the spark plug, and thoroughly inspect the mower for any damage. Repair the damage before restarting and operating the mower.

5. If the equipment should start to vibrate abnormally, stop the engine and check immediately for the cause. Vibration is generally a warning of trouble.
6. Stop the engine whenever you leave the mower, before cleaning the mower housing, and when making any repairs or inspections.
7. When cleaning, repairing or inspecting, make certain the blade and all moving parts have stopped. Disconnect the spark plug wire, and keep the wire away from the plug to prevent accidental starting.
8. Before attempting to unclog the mower or discharge chute, stop the engine and be sure the blade has stopped completely. The cutting blade continues to rotate for a few seconds after the engine is shut off. Never place any part of the body in the blade area until you are sure the blade has stopped rotating. Disconnect the spark plug wire and keep the wire away from the plug to prevent accidental starting.
9. Do not run the engine indoors.
10. Shut the engine off and wait until the blade comes to a complete stop before removing the grass catcher or unclogging chute.
11. Mow across the face of slopes, never up-and-down. Exercise extreme caution when changing direction on slopes. Do not mow excessively steep slopes.
12. Always disconnect electric mowers (line operated) before cleaning, repairing or adjusting.
13. Never operate mower without proper guards, plates or other safety protective devices in place.
14. Keep washout ports and other mower-housing service openings closed when mowing.
15. **DO NOT OPERATE** this mower with the chute doors open, unless the complete grass catcher is properly mounted on the mower.

### MAINTENANCE AND STORAGE

1. Check the blade and engine mounting bolts at frequent intervals for proper tightness.
2. Keep all nuts, bolts, and screws tight to be sure the equipment is in safe working condition.
3. Never store the equipment with gasoline in the tank inside of a building where fumes may reach an open flame or spark. Allow the engine to cool before storing in any enclosure.
4. To reduce fire hazard, keep the engine free of grass, leaves, or excessive grease.
5. Check the grass catcher bag frequently for wear or deterioration. For safety protection, replace only with new bag meeting original equipment specifications.

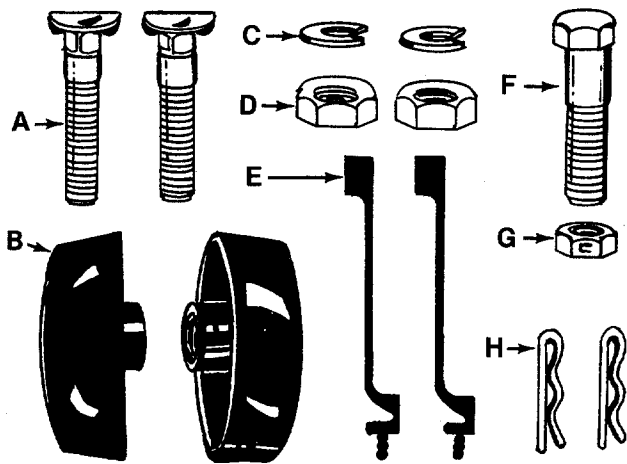

FIGURE 1.

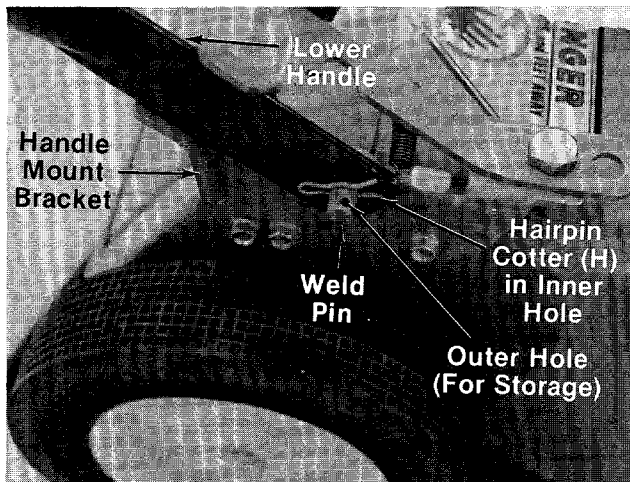

FIGURE 2.

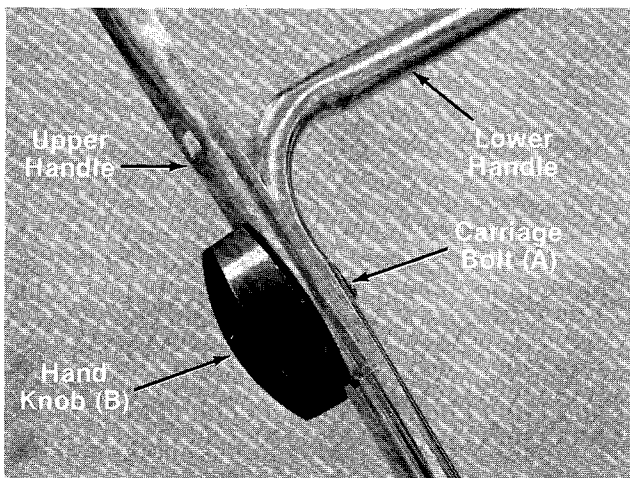

FIGURE 3. Folding Handle Only

## ASSEMBLY INSTRUCTIONS



This unit is shipped WITHOUT GASOLINE or OIL. After assembly, see operating section of this manual for proper fuel and engine oil recommendations.

1. Remove lawn mower and loose parts from carton. Make certain all parts and literature have been removed from the carton before the carton is discarded.
2. Extend throttle control which is attached to the engine and place on the floor. Be careful not to bend or kink control wire.

### Contents of hardware pack: (See Figure 1)

- A (2) Curved Head Carriage Bolts
- B (2) Hand Knobs (Folding Handle Only)
- C (2) Lock Washers 5/16" I.D. (Non-Folding Handle Only)
- D (2) Hex Nuts 5/16-18 Thread (Non-Folding Handle Only)
- E (2) Cable Ties
- F (1) Hex Bolt 1/4-20 x 1.50" Long
- G (1) Hex Lock Nut 1/4-20 Thread
- H (2) Hairpin Cotters

3. Fasten lower handle in position over weld pins in handle mount brackets on deck. Secure with hairpin cotters (H) in inner hole on weld pin. See figure 2.



There are two (2) holes in the handle mount brackets. Place the hairpin cotter in the inner hole for operation. Outer hole is for storage.



It may be necessary to bend the ends of the lower handle inward slightly to obtain a tight fit against the handle mount brackets.

4. There are two height positions for the handle. Place upper handle in position over lower handle, selecting hole for either high or low position. Refer to figure 12.

- ← **A. Units with Folding Handle**—Secure upper handle with two curved carriage bolts (A) and hand knobs (B) as shown in figure 3. The knobs may be assembled either to the inside or the outside of the handle.

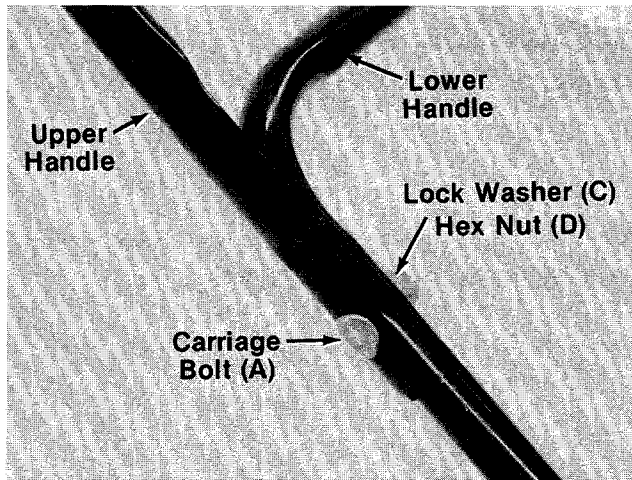

**FIGURE 4. Non-Folding Handle Only**

**B. Units with Non-Folding Handle**—Secure upper handle with two curved carriage bolts (A), lock washers (C) and hex nuts (D). See figure 4.

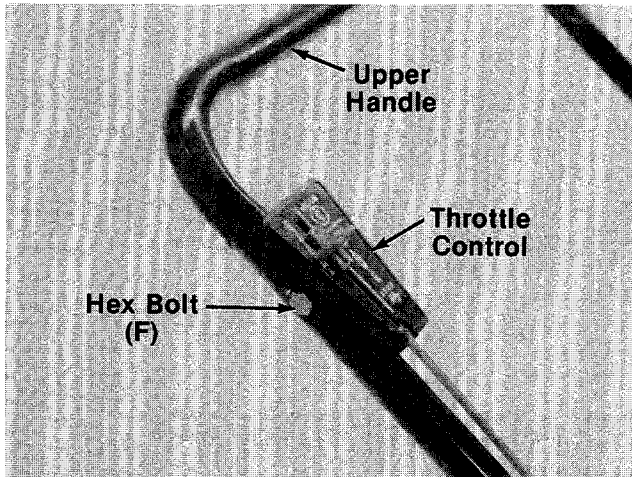
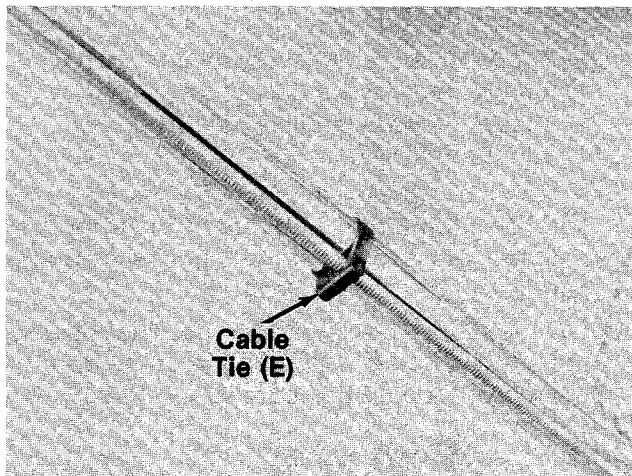

**FIGURE 5.**

5. Place the throttle control in position on right side of upper handle. Secure with hex bolt (F) and lock nut (G). See figure 5.

**NOTE**

Reference to right or left hand side of the mower is observed from the operating position.



**FIGURE 6.**

6. Secure throttle control wire to upper and lower handles with cable ties (E). See figure 6.

7. Check ALL nuts and bolts for correct tightness.

## ASSEMBLY Grass Catcher

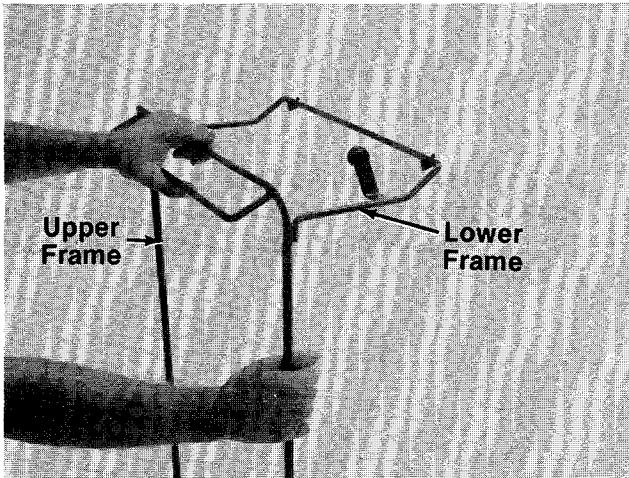

FIGURE 7.

1. Join the upper frame and lower frame assembly as shown in figure 7.

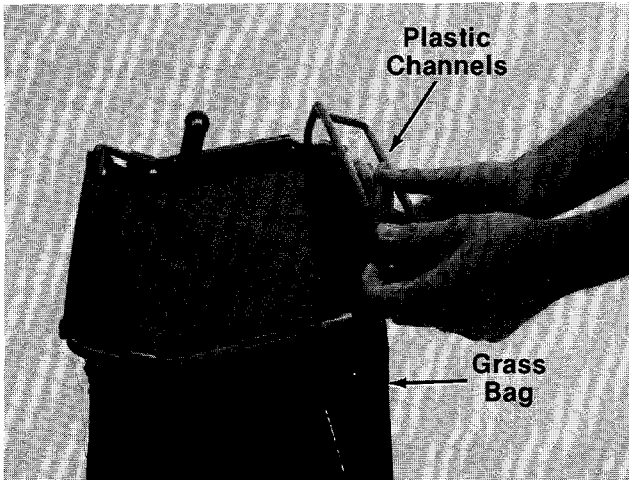

FIGURE 8.

2. Place bag over frame (black plastic side is the bottom of bag). Upper frame goes to the top of bag.
3. Secure bag to frame by slipping plastic channels on bag over frame. See figure 8.

## TO ATTACH BAG TO MOWER



**DO NOT** operate the mower with the chute door open unless the complete grass catcher is properly mounted on the mower.

1. Attach the grass catcher frame to grass catcher hitch bracket on rear of the mower by hooking grass catcher into hooks on grass catcher hitch bracket. See figure 9.
2. Lift the rear of grass catcher up. The roller on the grass catcher will push the chute door on the mower open. See figure 9.



Figure 9 is shown with the chute door open for photo clarity only.

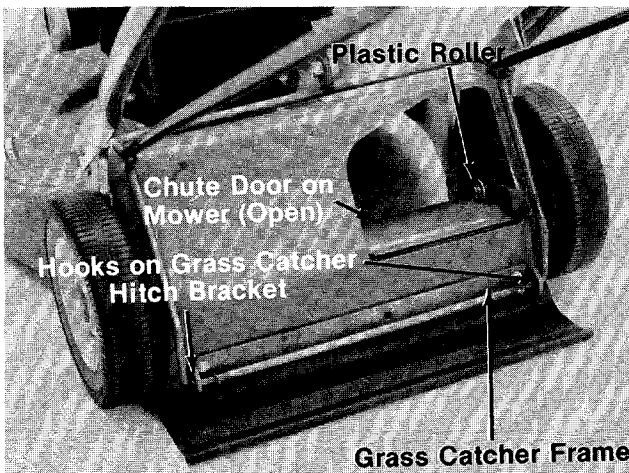

FIGURE 9.

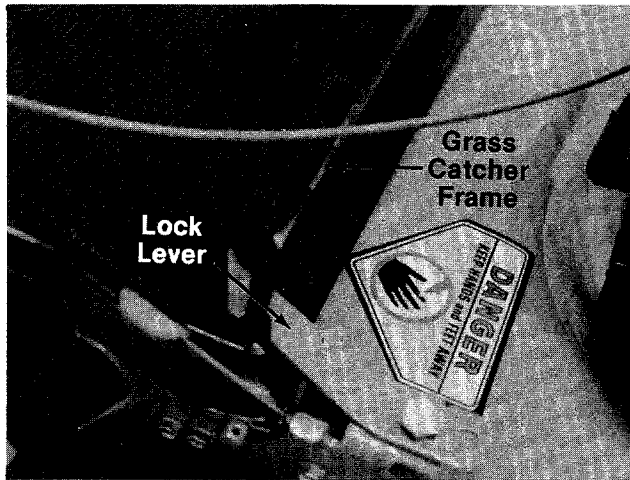

FIGURE 10.

The grass catcher frame will snap into place, secured by the lock lever. See figure 10.

← To remove the grass catcher, unhook the lock lever and slip the grass catcher off the unit. See figure 10.

## OPERATION

**DO NOT OPERATE THIS MOWER WITH THE CHUTE DOOR OPEN, UNLESS THE COMPLETE GRASSCATCHER IS PROPERLY MOUNTED ON THE MOWER.**



FIGURE 11.

Keep hands and feet away from the chute area on cutting deck. See figure 11.

## ➔ NOTE

For shipping purposes your mower is set with the wheels in a low cutting height position. For best results raise the cutting position until it is determined which height is best for your lawn. See adjustment section.

1. Fill sump with oil, using a high quality detergent oil classified "For Service SC, SD, SE or MS." Nothing should be added to the recommended oil.

Use SAE 30 oil. If not available, use SAE 10W-30 oil.

Place the engine level. Remove oil fill plug. Fill the oil sump full to point of overflowing. Pour slowly. Capacity 1¼ pints.

2. Fill fuel tank, using clean, fresh, leaded **regular** grade automotive gasoline. Fill tank completely!

**DO NOT MIX OIL WITH GASOLINE.**

3. When ready to start engine, place throttle control lever on handle in "START" position and start engine in accordance with instructions in engine manual. After engine starts, move throttle control lever on handle to desired engine speed. The engine is stopped by placing control lever on handle in the "STOP" position.

Be sure that lawn is clear of stones, sticks, wire, or other objects which could damage lawn mower or engine. For best results and to insure more

even grass distribution, do not mow when lawn is excessively wet.

 **IMPORTANT**

If you strike a foreign object, stop the engine. Remove wire from spark plug, thoroughly inspect the mower for any damage, and repair the damage before restarting and operating the mower.



Unless the entire grass catcher is correctly positioned on the mower, do not open the discharge chute door when the engine is running.

### USING YOUR ROTARY MOWER

For the best results, do not cut wet grass because it tends to stick to the underside of the mower, preventing proper bagging of grass clippings. If wet grass must be cut, reduce walking speed.

New grass, thick grass or wet grass may require a narrower cut. Blade speed should be adjusted to the condition of the lawn.

For best results, cut off one-third or less of the total length of the grass. Lawn should be cut in the fall as long as there is growth.

## ADJUSTMENTS



Do not at any time make any adjustment to lawn mower without first stopping engine and disconnecting spark plug wire.

### CUTTING HEIGHT

Adjustment is made by removing and moving axle bolts to desired position. Cutting heights will be raised as axle bolts are moved to a lower hole and lowered as axle bolts are moved to a higher hole in the deck. All axle bolts must be mounted in the same relative position to the deck. The cupped side of the belleville washers must be against the deck. The spacers must be assembled between the rear wheels and the belleville washers.

### HANDLE POSITION

The upper handle can be adjusted to a high or low position. The adjustment is made by removing the two knobs or hex nuts and lock washers, removing the two curved carriage bolts and reassembling in the other position. See figure 12.

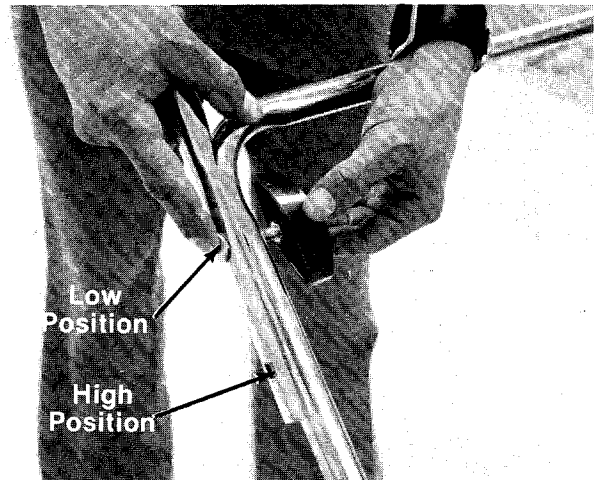

FIGURE 12.

### THROTTLE

If adjustment becomes necessary, the throttle control wire assembly can be reset as follows:

1. Loosen, but do not remove, screw securing throttle control wire assembly at engine. See figure 13.

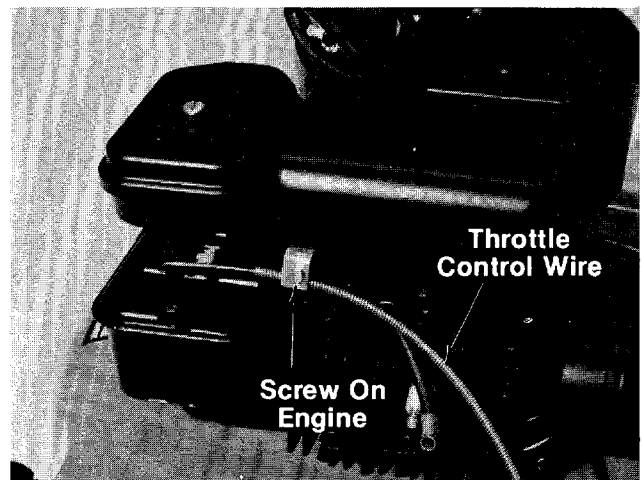

FIGURE 13.

2. Move throttle control lever on handle to "FAST" position.
3. Move lever, to which control wire is fastened at engine, to full open position and retighten screw to secure throttle control wire assembly.



## CARBURETOR ADJUSTMENTS



**WARNING**

If any adjustments are made to the engine while the engine is running (e.g. carburetor), disengage all clutches and blades. Keep clear of all moving parts. Be careful of heated surfaces and muffler.

Minor carburetor adjustment may be required to compensate for differences in fuel, temperature, altitude and load.

All carburetor adjustments should be made with the air cleaner on engine. Air cleaner mounting screw must be in carburetor when engine is run. Best adjustment is made with a fuel tank half full of gasoline.

Refer to the separate engine manual packed with your mower for carburetor adjustment information.

## LUBRICATION



**IMPORTANT**

Always stop engine and disconnect spark plug wire before cleaning, lubricating or doing any kind of work on lawn mower.

**Discharge Chute Door Mechanism**—The torsion spring and pivot point should be lubricated periodically with light oil to prevent any rust or binding. Door must work freely.

**Wheels**—Mower may be provided with optional ball bearing wheels. Lubricate at least once a season with light oil. Also, if the wheels are removed for any reason, lubricate the surface of the axle bolt and the inner surface of the wheel with light oil. A 4 oz. plastic bottle of light oil lubricant is available. Order part number 737-0170. Engine oil may also be used.

**Engine**—Follow engine manual for lubrication instructions.

**Throttle**—Periodically lubricate throttle control lever and throttle wire assembly with a few drops of light oil for ease of operation.

## MAINTENANCE

### CUTTING BLADE

#### A. Removal for Sharpening or Replacement



**WARNING**

Be sure to disconnect and ground the spark plug wire before working on the cutting blade to prevent accidental engine starting.

1. Remove the large bolt and lock washer which holds the blade and adapter to the engine crankshaft.
2. Remove the blade and adapter from the crankshaft. Be careful not to lose the key on the crankshaft.
3. If the blade or blade adapter needs replacing, remove the two small bolts, lock washers and nuts which hold the blade to the adapter.

#### B. Sharpening

Remove the cutting blade by following the directions of the preceding section.

When sharpening the blade, follow the original angle of grind as a guide. It is **extremely important** that each cutting edge receives an equal amount of grinding to prevent an unbalanced blade. An unbalanced blade will cause excessive vibration when rotating at high speeds, may cause damage to the mower and could break, causing personal injury.

The blade can be tested for balance by balancing it on a round shaft screwdriver. Remove metal from the heavy side until it balances evenly.



**NOTE**

It is recommended that the blade always be removed from the adapter for the best test of balance.

#### C. Reassembly

Before reassembling the blade and the blade adapter to the unit, lubricate the engine crankshaft and the inner surface of the blade adapter with light oil. Lubricating the bolt holes, bolts and inner surface of the nuts with light oil is also recommended. A 4 oz. plastic bottle of light oil lubricant is available. Order part number 737-0170. Engine oil may also be used.

When replacing the blade, be sure to install the blade with the side of the blade marked "Bottom" (or with part number) facing the ground when the mower is in the operating position. Make certain key is in place on the crankshaft.

#### Blade Mounting Torque

3/8" Dia. Bolt 375 in. lb. min., 450 in. lb. max.  
5/16" Dia. Bolt 150 in. lb. min., 250 in. lb. max.

To insure safe operation of your unit, ALL nuts and bolts must be checked periodically for correct tightness.

### DECK

The underside of mower deck should be cleaned after each period of use as grass clippings, leaves, dirt and other matter will accumulate. This accumulation of grass clippings, etc., is undesirable as it will invite rust and corrosion and may cause an uneven discharge of grass clippings at the next cutting.

The deck may be cleaned by tilting the mower forward or on its side and scraping clean with a suitable tool or by washing with a stream of water from a garden hose.



### CAUTION

Do not direct the stream of water at a hot engine as damage to the engine may result.

### ENGINE OIL

Check oil level before starting engine and after every 5 hours of operation. ADD oil as necessary to keep level full to point of overflowing. Before removing oil fill plug, clean area around plug to prevent dirt from entering oil fill opening. Engine should be in a level position when checking oil.

Change oil after first 5 hours of operation. Thereafter change every 25 hours. Change oil while engine is warm. Oil may be drained thru oil fill opening by tipping the unit on its side. Oil capacity 1-1/4 pints.

### AIR CLEANER

Service air cleaner every 25 hours under normal conditions. Clean every few hours under extremely dusty conditions. Poor engine performance and flooding usually indicates that the air cleaner should be serviced.

To service the air cleaner, refer to the separate engine manual packed with your unit.

### SPARK PLUG

The spark plug should be cleaned and the gap reset once a season. Spark plug replacement is recommended at the start of each mowing season; check engine manual for correct plug type and gap specifications.

## OFF-SEASON STORAGE

If the machine is to be inoperative for a period longer than 30 days, the following procedures are recommended:

1. Working outdoors, drain all fuel from the fuel

tank. Use a clean dry cloth to absorb the small amount of fuel remaining in the tank. Then run the engine until all fuel in the carburetor is exhausted.



### WARNING

Do not drain fuel while smoking, or if near an open fire.

2. Drain all the oil from the crankcase (this should be done after the engine has been operated and is still warm). Refill the crankcase with clean new oil.
3. Disconnect the spark plug wire and remove the spark plug from the cylinder. Pour about 2 or 3 tablespoons of engine oil into the cylinder. Turn the engine over several times to spread out the oil. Replace the spark plug, but do not connect the wire.
4. Clean the engine and the entire mower thoroughly.
5. Lubricate all lubrication points.

## HANDLE STORAGE

The handle may be placed in an upright position for storage.

Move hairpin cotters to outer hole on weld pins. See figure 2. Press outward on the bottom of the lower handle and push forward. The handle will lock in this position.

Reverse the above procedure to place the handle in the operating position.

**On units with folding handles**, the handle may be folded away completely for storage.

1. Remove hairpin cotters from inner hole on weld pins on handle mount brackets. Place in outer hole. See figure 2.
2. Loosen the two hand knobs on each side of the handle.
3. Push outward on the bottom of each side of the lower handle and push forward.
4. Fold the upper handle back and down.

To take the handle out of storage position:

1. Lift the upper handle up and towards the rear.
2. Pull the handle back until it locks into the operator's position.
3. Tighten the two hand knobs securely.
4. Move the hairpin cotters to the inner hole on the weld pins.

 **NOTE**

The use of any accessory on this Rotary Mower other than those manufactured by the mower manufacturer is **not** recommended.



**WARNING**

DO NOT operate the mower with the chute door open unless the complete grass catcher is properly mounted on the mower.



**WARNING**

The mower should not be operated without the protective shield on the rear of the mower in place.

 **NOTE**

Under normal usage bag material is subject to wear and should be checked periodically. Be sure any replacement bag complies with the mower manufacturer's recommendations.

For replacement bags, use only factory authorized replacement bag No. 764-0171.

# Model 310

IF YOU WRITE TO US ABOUT THIS ARTICLE  
OR IF YOU ORDER REPLACEMENT PARTS AL-  
WAYS MENTION THIS MODEL & SERIAL NO  
MODEL

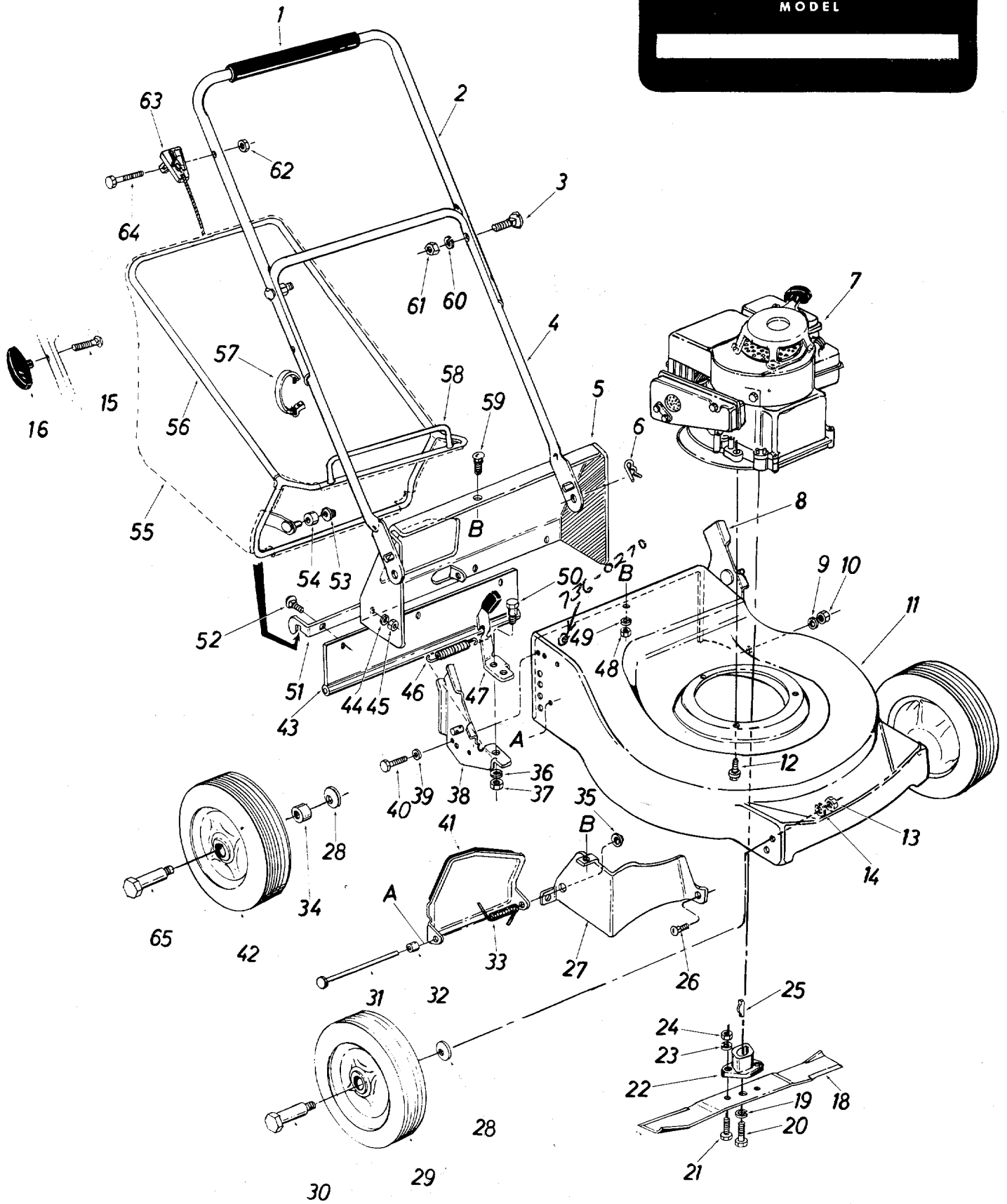

# Model 310

## PARTS LIST FOR MODEL 310 ROTARY MOWER

REF. NO.	PART NO.	COLOR CODE	DESCRIPTION	NEW PART	REF. NO.	PART NO.	COLOR CODE	DESCRIPTION	NEW PART
1	718-0145		Grip		33	732-0346		Torsion Spring	
2	749-0402		Upper Handle (Chrome)		34	750-0515		Spacer	
	749-0380		Upper Handle (Painted)		35	726-0106		Cap Speed Nut 1/4" Rod	
3	710-0671		Curved Hd. Carriage Bolt 5/16-18 x 1.38" Lg.		36	736-0119		L-Wash. 5/16" I.D.*	
					37	712-0267		Hex Nut 5/16-18 Thd.*	
4	749-0505		Lower Handle (Chrome)	N	38	14592 <sup>329</sup>		Handle Mount Brkt.—R.H.	N
	749-0504		Lower Handle (Painted)	N	39	736-0142		FI-Wash. .281" I.D. x .50"	
5	14585	—486	Rear Deck Section	N		<sup>412</sup>		O.D. x .063	
6	714-0104		Internal Cotter Pin		40	<del>710-0776</del>		Hex Wash. Hd. Self-Tap Scr. 1/4 x .62" Lg.	
7	—		Engine						
8	12297		Handle Mount Brkt.—L.H.		41	13407	—486	Chute—Door	
9	736-0329		L-Wash. 1/4" I.D.*		42	734-0841		Rear Wheel Ass'y. Comp. 8 x 1.75	
10	712-0287		Hex Nut 1/4-20 Thd.*						
11	14501	—486	20" Deck Ass'y.	N	43	731-0432		Rear Protective Flap Ass'y.	
12	710-0654		Hex Wash. Hd. Self-Tap Scr. 3/8-16 x .88" Lg.		44	736-0211		FI-Wash. .285 I.D. x 1.25" O.D.	
13	712-0798		Hex Nut 3/8-16 Thd.*		45	712-0271		Hex Sems Nut 1/4-20 Thd.	
14	736-0169		L-Wash. 3/8" I.D.*		46	732-0357		Extension Spring .33" O.D. x 1.12" Lg.	
15	710-0405		Curved Hd. Carriage Bolt 5/16-18 x 1.75" Lg. (Optional)		47	14845		Grass Catcher Lock Lever	N
					48	712-0287		Hex Nut 1/4-20 Thd.*	
16	09966		Hand Knob (Optional)		49	736-0329		L-Wash. 1/4" I.D.*	
18	742-0123		20" Blade		50	738-0155		Shoulder Bolt .437" Dia. x .162" Lg.	
19	736-0217		L-Wash. 3/8" I.D. Heavy Duty						
20	710-0459		Hex Bolt 3/8-24 x 1.50" Lg. (Grade 5)		51	14012	—486	Grass Catcher Hitch Brkt.	
21	710-0117		Hex Bolt 5/16-24 x 1.00" Lg. (Grade 5)		52	710-0703		Carriage Bolt 1/4-20 x .75" Lg.*	
22	10769		Blade Adapter Kit		53	726-0100		Cap Speed Nut 3/8" Rod	
23	736-0119		L-Wash. 5/16" I.D.*		54	731-0430		Plastic Roller	
24	712-0123		Hex Nut 5/16-24 Thd.*		55	764-0171		Grass Bag	
25	714-0365		#6 Hi-Pro Key 5/32 x .62" Dia.		56	749-0278		Grass Catcher Upper Frame	
26	710-0167		Carriage Bolt 1/4-20 x .50" Lg.*		57	726-0188		Cable Tie	
					58	14582		Lower Grass Catcher Frame Ass'y.	N
27	14586	—486	Rear Baffle		59	710-0167		Carriage Bolt 1/4-20 x .50" Lg.*	
28	736-0105		Belleville Wash.						
29	734-0840		Front Wheel Ass'y. Comp. 7 x 1.50		60	736-0119		L-Wash. 5/16" I.D.*	
					61	712-0267		Hex Nut 5/8-16 Thd.*	
30	738-0213		Shoulder Bolt (Front Axle)		62	712-0107		Hex Cent. L-Nut 1/4-20 Thd.	
31	738-0386		Hinge Pin .25" Dia. x 7.88" Lg.		63	746-0316		Throttle Control	
					64	710-0606		Hex Bolt 1/4-20 x 1.50" Lg.*	
32	750-0218		Spacer .262" I.D. x .31" O.D. x .58" Lg.		65	738-0509		Shoulder Bolt (Rear Axle)	

\*For faster service obtain standard nuts, bolts, and washers locally. If these items cannot be obtained locally, order by part number and size as shown on parts list.

(486—Star Orange) When ordering parts if color or finish is important, use the appropriate color code shown at left. (e.g. Star Orange Finish—11907 (486).)

The engine is not under warranty by the mower manufacturer. If repairs or service is needed on the engine, please contact your nearest authorized engine service outlet. Check the "Yellow Pages" of your telephone book under "Engines—Gasoline."

Find It Fast  
In The  
Yellow Pages



This instruction manual covers various models and all specifications shown do not necessarily apply to your model. Specifications subject to change without notice or obligation.



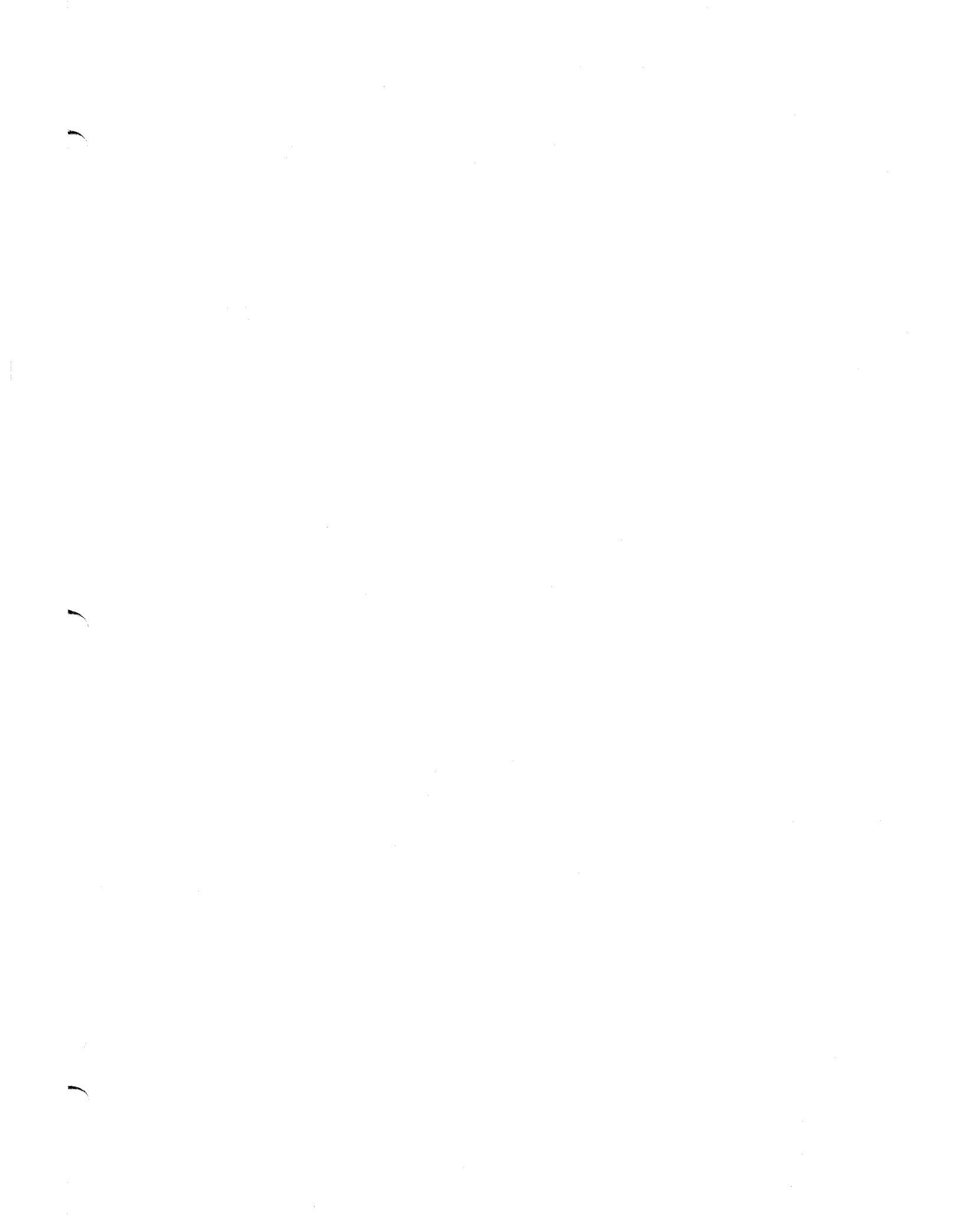

# PARTS INFORMATION

## POWER EQUIPMENT PARTS AND SERVICE

Parts and service for all MTD manufactured power equipment are available through the authorized service firms listed below. All orders should specify the model number of your unit, part numbers, description of parts and the quantity of each part required.

**NOTE:** If any parts are found to be missing or defective upon assembly of this unit, write to advise the factory so that immediate replacement can be made.

<b>ALABAMA</b>	<b>BIRMINGHAM</b>	
Auto Electric & Carburetor Co. . . . .	2625 4th Ave. S. . . . .	35233
<b>ARKANSAS</b>	<b>FORT SMITH</b>	
Mity Mite Motors, Inc. . . . .	4515 S. 16th St. . . . .	72901
Sutton's Lawn Mower Shop . . . . .	<b>NORTH LITTLE ROCK</b>	
	Rt. 4, Box 368 . . . . .	72117
<b>CALIFORNIA</b>	<b>PORTERVILLE</b>	
Billious . . . . .	75 North D Street . . . . .	93257
<b>COLORADO</b>	<b>DENVER</b>	
Spitzer Industrial Products Co. . . . .	6601 N. Washington St., Box 29114 . . . . .	80229
<b>FLORIDA</b>	<b>JACKSONVILLE</b>	
Radco Distributors . . . . .	4909 Victor St., Box 5459 . . . . .	32207
Small Eng. Dist. . . . .	<b>OPA LOCKA</b>	
	2351 N.W. 147th St. . . . .	33054
<b>GEORGIA</b>	<b>EAST POINT</b>	
East Point Cycle & Key . . . . .	2834 Church St. . . . .	30344
<b>ILLINOIS</b>	<b>LYONS</b>	
Keen Edge Co. . . . .	8615 Ogden Ave. . . . .	60534
<b>INDIANA</b>	<b>ELKHART</b>	
Parts & Sales Inc. . . . .	2101 Industrial Pkwy. . . . .	46514
<b>IOWA</b>	<b>DUBUQUE</b>	
Power Lawn & Garden Equip. . . . .	2551 J.F. Kennedy . . . . .	52001
<b>LOUISIANA</b>	<b>NEW ORLEANS</b>	
Suhren Engine Co. . . . .	8330 Earhart Blvd. . . . .	70118
<b>MARYLAND</b>	<b>TAKOMA PARK</b>	
Center Supply Co. . . . .	6867 New Hampshire Ave. . . . .	20012
<b>MASSACHUSETTS</b>	<b>SPRINGFIELD</b>	
Morton B. Collins Co. . . . .	300 Birnie Ave. . . . .	01107
<b>MICHIGAN</b>	<b>LANSING</b>	
Lorenz Service Co. . . . .	2500 S. Pennsylvania . . . . .	48910
Power Equipment Dist. . . . .	<b>MOUNT CLEMENS</b>	
	340 Hubbard . . . . .	48043
<b>MINNESOTA</b>	<b>HOPKINS</b>	
Hance Distributing Inc. . . . .	420 Excelsior Ave. W. . . . .	55343
<b>MISSISSIPPI</b>	<b>BILOXI</b>	
Biloxi Sales & Service, Inc. . . . .	506 Caillavet St. . . . .	39533
<b>MISSOURI</b>	<b>KANSAS CITY</b>	
Automotive Equip. Service . . . . .	3117 Holmes St. . . . .	64109
Ross-Frazier Supply Co. . . . .	<b>ST. JOSEPH</b>	
	8th and Monterey . . . . .	64503
Henzler, Inc. . . . .	<b>ST. LOUIS</b>	
	2015 Lemay Ferry Rd. . . . .	63125
<b>NEW JERSEY</b>	<b>BELLMAWR</b>	
Lawnmower Parts Inc. . . . .	717 Creek Rd. . . . .	08030
<b>NEW MEXICO</b>	<b>ALBUQUERQUE</b>	
Spitzer Eng. & Parts . . . . .	1023 Third St. N.W. . . . .	87103
<b>NEW YORK</b>	<b>CARTHAGE</b>	
Gamble Dist., Inc. . . . .	West End Ave. . . . .	13619

## BRIGGS AND STRATTON, TECUMSEH AND PEERLESS PARTS AND SERVICE

Briggs & Stratton, Tecumseh and Peerless parts and service should be handled by your nearest authorized engine service firm. Check the yellow pages of your telephone directory under the listing **Engines—Gasoline**, Briggs & Stratton or Tecumseh Lauson.

<b>NORTH CAROLINA</b>	<b>GOLDSBORO</b>	
Smith Hardware Co. . . . .	515 N. George St. . . . .	27530
Dixie Sales Company . . . . .	<b>GREENSBORO</b>	
	335 N. Green . . . . .	27402
<b>OHIO</b>	<b>CARROLL</b>	
Stebe's Mid-State Mower Supply . . . . .	71 High St., Box 366 . . . . .	43112
Bleckrie, Inc. . . . .	<b>CLEVELAND</b>	
	7900 Lorain Ave. . . . .	44102
National Central . . . . .	<b>WADSWORTH</b>	
	687 Seville Rd. . . . .	44281
Burton Supply Co. . . . .	<b>YOUNGSTOWN</b>	
	1301 Logan Ave., Box 929 . . . . .	44501
<b>OKLAHOMA</b>	<b>MUSKOGEE</b>	
Victory Motors, Inc. . . . .	605 S. Cherokee . . . . .	74401
<b>OREGON</b>	<b>PORTLAND</b>	
Kenton Supply Co. . . . .	8216 N. Denver Ave. . . . .	97217
<b>PENNSYLVANIA</b>	<b>HARRISBURG</b>	
EECO Inc. . . . .	4021 N. 6th St. . . . .	17110
Thompson Rubber Co. . . . .	<b>PHILADELPHIA</b>	
	5222-24 N. Fifth St. . . . .	19120
Bluemont Co. . . . .	<b>PITTSBURGH</b>	
	11125 Frankstown Rd. . . . .	15235
Frank Roberts & Sons . . . . .	<b>PUNXSUTAWNEY</b>	
	R.D. 2 . . . . .	15767
<b>TENNESSEE</b>	<b>KNOXVILLE</b>	
Master Repair Service . . . . .	2000 Western Ave. . . . .	37921
American Sales & Service, Inc. . . . .	<b>MEMPHIS</b>	
	3035-43 Bellbrook . . . . .	38111
<b>TEXAS</b>	<b>DALLAS</b>	
Marr Brothers, Inc. . . . .	423 E. Jefferson . . . . .	75203
Woodson Sales Corp. . . . .	<b>FORT WORTH</b>	
	1702 N. Sylvania . . . . .	76111
Bullard Supply Co. . . . .	<b>HOUSTON</b>	
	2409 Commerce St. . . . .	77003
<b>UTAH</b>	<b>SALT LAKE CITY</b>	
A-1 Engine & Mower Co. . . . .	437 E. 9th St. . . . .	84111
<b>VERMONT</b>	<b>BURLINGTON</b>	
Vermont Hdwe. Co. Inc. . . . .	180 Flynn Ave. . . . .	05401
<b>VIRGINIA</b>	<b>ASHLAND</b>	
RBI Corp. . . . .	Lake Ridge Park, 101 Cedar Run Dr. . . . .	23005
<b>WASHINGTON</b>	<b>SEATTLE</b>	
Bailey's Inc. . . . .	1414 14th Ave. . . . .	98102
<b>WEST VIRGINIA</b>	<b>CHARLESTON</b>	
Young's, Inc. . . . .	233 Virginia St., E. . . . .	25301
<b>WISCONSIN</b>	<b>MARSHFIELD</b>	
Power Pac . . . . .	301 E. 29th St. . . . .	54449

## WARRANTY PARTS AND SERVICE POLICY

The purpose of warranty is to protect the customer from defects in workmanship and materials, defects which are NOT detected at the time of manufacture. It does not provide for the unlimited and unrestricted replacement of parts. Use and maintenance are the responsibility of the customer. The manufacturer cannot assume responsibility for conditions over which it has no control. Simply put, if it's the manufacturer's fault, it's the manufacturer's responsibility; if it's the customer's fault, it's the customer's responsibility.

### CLAIMS AGAINST THE MANUFACTURER'S WARRANTY INCLUDES:

1. Replacement of Missing Parts on new equipment.
2. Replacement of Defective Parts within the warranty period.
3. Repair of Defects within the warranty period.

All claims MUST be substantiated with the following information:

1. Model Number of unit involved.
2. Date unit was purchased or first put into service.
3. Date of failure.
4. Nature of failure.