

OWNER'S GUIDE

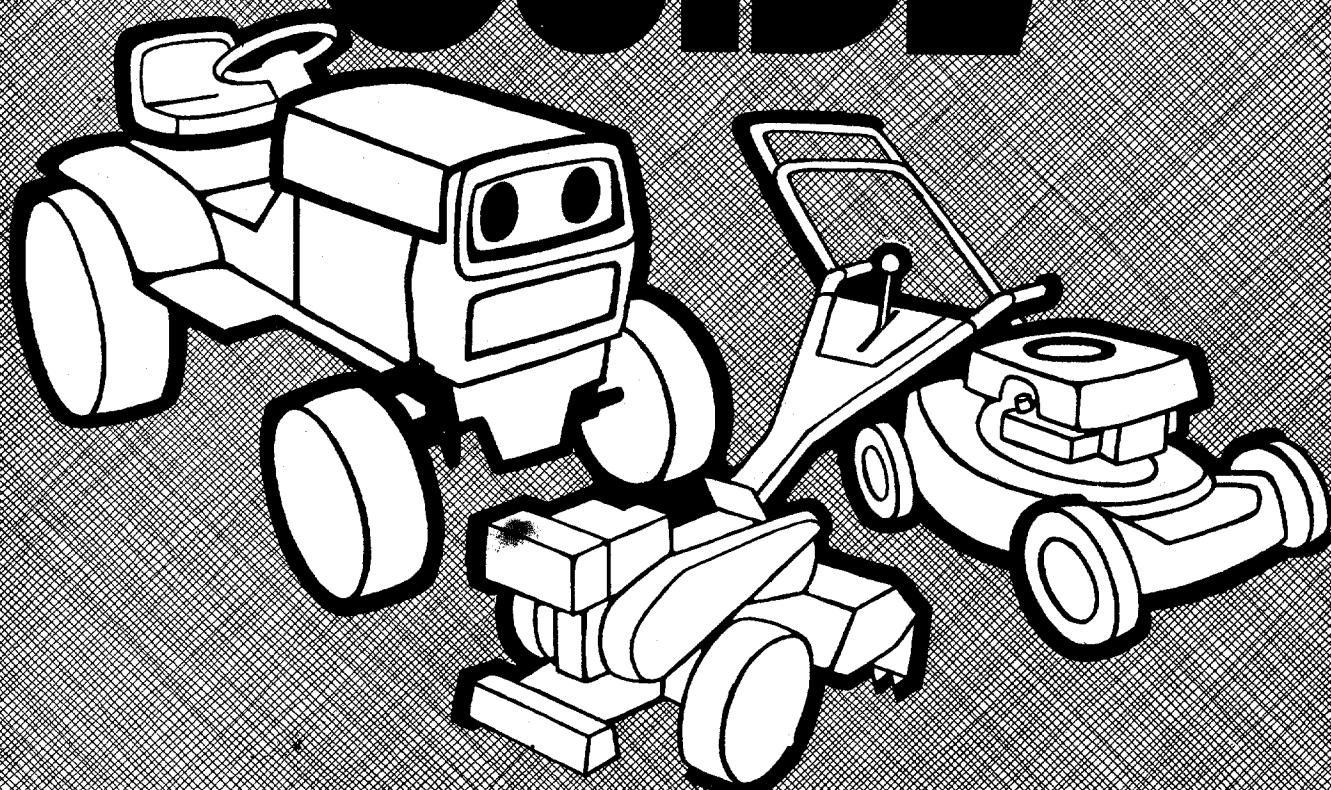

ASSEMBLY • OPERATION • MAINTENANCE • PARTS

20" & 22" ROTARY MOWERS

Important:

**Read Safety Rules and
Instructions Carefully**

Thank you for purchasing an
American built product.

Model Numbers

**111-112A
111-126A**

INDEX

Safe Operation Practices.....	3	Using Your Rotary Mower.....	10
Assembly Instructions.....	4	Off-Season Storage.....	10
Operation Instructions.....	6	Exploded Parts View.....	12
Adjustments.....	6	Repair Parts List.....	13
Lubrication.....	8	Parts Information.....	Back Cover
Maintenance.....	8		

LIMITED WARRANTY

For one year from the date of original retail purchase, MTD PRODUCTS INC will either repair or replace, at its option, free of charge, F.O.B. factory or authorized service firm, any part or parts found to be defective in material or workmanship. Transportation charges for any parts submitted for replacement under this warranty must be paid by the purchaser unless such return is requested by MTD PRODUCTS INC.

This warranty will not apply to any part which has become inoperative due to misuse, excessive use, accident, neglect, improper maintenance, alterations, or unless the unit has been operated and maintained in accordance with the instructions furnished. This warranty does not apply to the engine, motor, battery, battery charger or component parts thereof. Please refer to the applicable manufacturer's warranty on these items.

This warranty will not apply where the unit has been used commercially.

Warranty service is available through your local authorized service dealer or distributor. If you do not know the dealer or distributor in your area, please write to the Customer Service Department of MTD.

The return of a complete unit will not be accepted by the factory unless prior written permission has been extended by MTD.

This warranty gives you specific legal rights. You may also have other rights which vary from state to state.



WARNING

TO PURCHASERS OF INTERNAL COMBUSTION ENGINE EQUIPPED MACHINERY OR DEVICES IN THE STATE OF CALIFORNIA

The equipment which you have just purchased does not have a spark arrester. If this equipment is used on any forest covered land, brush covered land, or grass covered unimproved land in the State of California, before using on such land, the California law requires that a spark arrester be provided. In addition, spark arrester is required by law to be in effective working order. The spark arrester must be attached to the exhaust system and comply with Section 4442 of the California Public Resources Code.



WARNING

To reduce the potential for any injury, comply with the following safety instructions. Failure to comply with the instructions may result in personal injury.

SAFE OPERATION PRACTICES FOR WALK-BEHIND MOWERS

TRAINING

1. It is suggested that this manual be read in its entirety before attempting to assemble or operate this unit. Keep this manual in a safe place for future reference and for ordering replacement parts.
2. Your rotary mower is a precision piece of power equipment, not a plaything. Therefore, exercise extreme caution at all times.
3. Read this Owner's Manual carefully. Be thoroughly familiar with the controls and the proper use of the equipment.
4. Never allow children to operate a power mower. Only persons well acquainted with these rules of safe operation should be allowed to use your mower.
5. Keep the area of operation clear of all persons, particularly small children and pets. Stop engine when they are in the vicinity of your mower. Although the area of operation should be completely cleared of foreign objects, a small object may have been overlooked and could be accidentally thrown by the mower in any direction and cause injury.
4. After striking a foreign object, stop the engine, remove the wire from the spark plug, and thoroughly inspect the mower for any damage. Repair the damage before restarting and operating the mower.
5. If the equipment should start to vibrate abnormally, stop the engine and check immediately for the cause. Vibration is generally a warning of trouble.
6. Stop the engine whenever you leave the mower, before cleaning the mower housing, and when making any repairs or inspections.
7. When cleaning, repairing or inspecting, make certain the blade and all moving parts have stopped. Disconnect the spark plug wire, and keep the wire away from the plug to prevent accidental starting.
8. Before attempting to unclog the mower or discharge chute, stop the engine and be sure the blade has stopped completely. The cutting blade continues to rotate for a few seconds after the engine is shut off. Never place any part of the body in the blade area until you are sure the blade has stopped rotating. Disconnect the spark plug wire and keep the wire away from the plug to prevent accidental starting.

PREPARATION

1. Thoroughly inspect the area where the equipment is to be used. Remove all stones, sticks, wire, bones and other foreign objects which could be picked up and thrown by the mower in any direction and cause injury.
2. Do not operate equipment when barefoot or wearing open sandals. Always wear substantial footwear.
3. Do not wear loose fitting clothing that could get caught on the mower.
4. Check the fuel before starting the engine. Gasoline is an extremely flammable fuel. Do not fill the gasoline tank indoors, while the engine is running, or while the engine is still hot. Wipe off any spilled gasoline before starting the engine as it may cause a fire or explosion.
5. Disengage the self-propelled mechanism or drive clutch on units so equipped before starting the engine.
6. Never attempt to make a wheel or cutting height adjustment while the engine is running.
7. Mow only in daylight or in good artificial light.
8. Never operate the equipment in wet grass. Always be sure of your footing. Keep a firm hold on the handle and walk, never run.
9. Do not run the engine indoors.
10. Shut the engine off and wait until the blade comes to a complete stop before removing the grass catcher or unclogging chute.
11. Mow across the face of slopes, never up-and-down. Exercise extreme caution when changing direction on slopes. Do not mow excessively steep slopes.
12. Always disconnect electric mowers (line operated) before cleaning, repairing or adjusting.
13. Never operate mower without proper guards, plates or other safety protective devices in place.
14. Keep washout ports and other mower-housing service openings closed when mowing.

MAINTENANCE AND STORAGE

1. Check the blade and engine mounting bolts at frequent intervals for proper tightness.
2. Keep all nuts, bolts, and screws tight to be sure the equipment is in safe working condition.
3. Never store the equipment with gasoline in the tank inside of a building where fumes may reach an open flame or spark. Allow the engine to cool before storing in any enclosure.
4. To reduce fire hazard, keep the engine free of grass, leaves, or excessive grease.
5. Check the grass catcher bag frequently for wear or deterioration. For safety protection, replace only with new bag meeting original equipment specifications.

OPERATION

1. Do not change the engine governor settings or overspeed the engine. Excessive engine speeds are dangerous.
2. Do not put hands or feet near or under rotating parts. Keep clear of the discharge opening at all times as the rotating blade can cause injury.
3. Stop the blade when crossing gravel drives, walks or roads.

ASSEMBLY INSTRUCTIONS

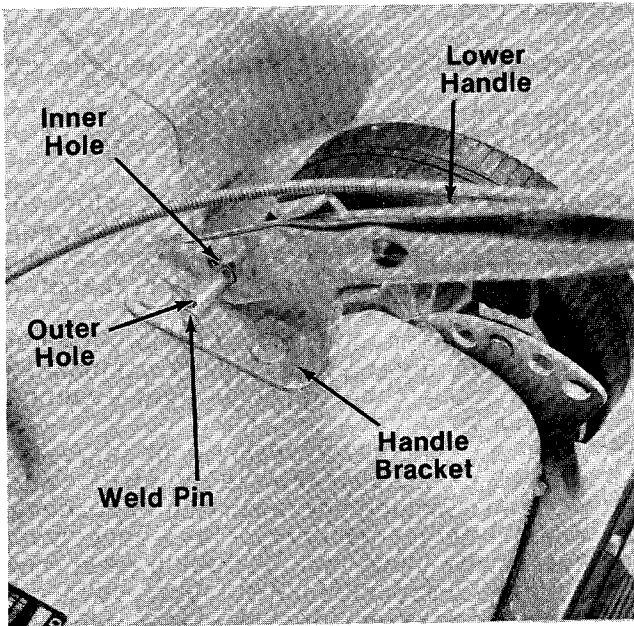

FIGURE 1.

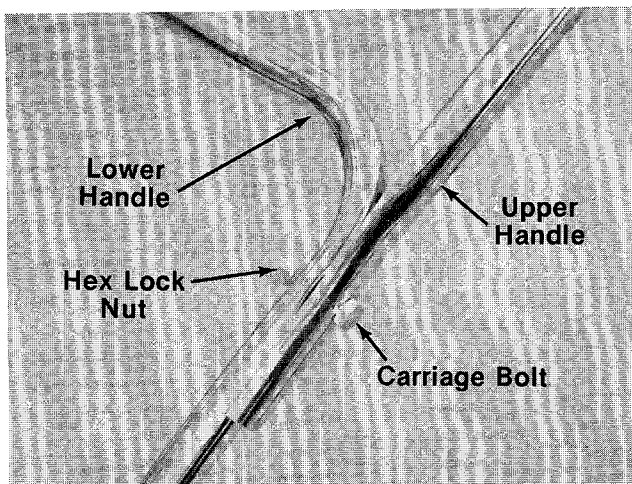

FIGURE 2.

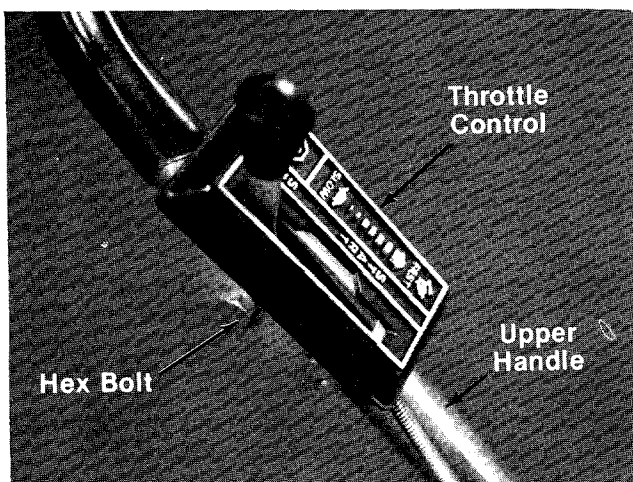

FIGURE 3.

NOTE

This unit is shipped WITHOUT GASOLINE or OIL. After assembly, see operating section of this manual for proper fuel and engine oil recommendations.

1. Extend throttle control which is attached to the engine at the rear of the mower and place on the floor. Be careful not to bend or kink control wire.
2. Fasten hole in lower handle over weld pins in handle mount brackets on deck. Secure with hairpin cotters in inner hole on weld pin. See figure 1.

NOTE

There are two (2) holes in the handle mount brackets. Place the lower handle against the brackets and secure with hairpin cotter in the inner hole. Inner hole is for operation. Outer hole is for storage.

NOTE

It may be necessary to pull open the ends of the lower handle. This will insure a tight fit when assembled into handle mount brackets.

3. Assemble upper handle to lower handle. Secure with two carriage bolts and hex lock nuts as shown in figure 2.

NOTE

There are two height positions for the handle. See adjustment section.

4. Place the throttle control in position on right side of upper handle. Secure with hex bolt and lock nut. See figure 3.

NOTE

Reference to right and left hand sides of the unit is observed from the operating position.

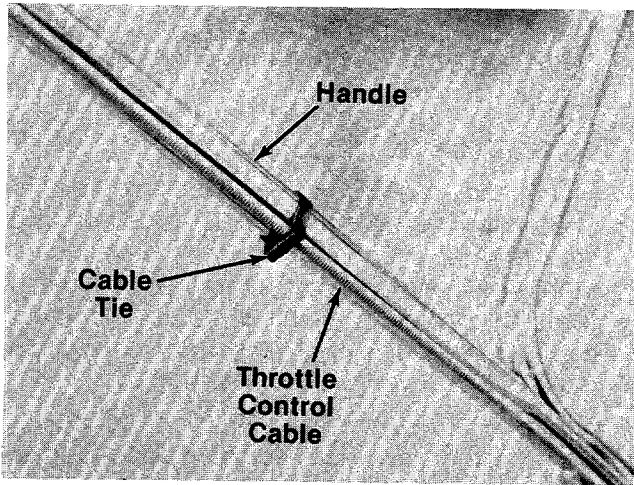

FIGURE 4.

5. Secure throttle control cable to handle with ties provided. See figure 4.
6. Check ALL nuts and bolts for correct tightness.

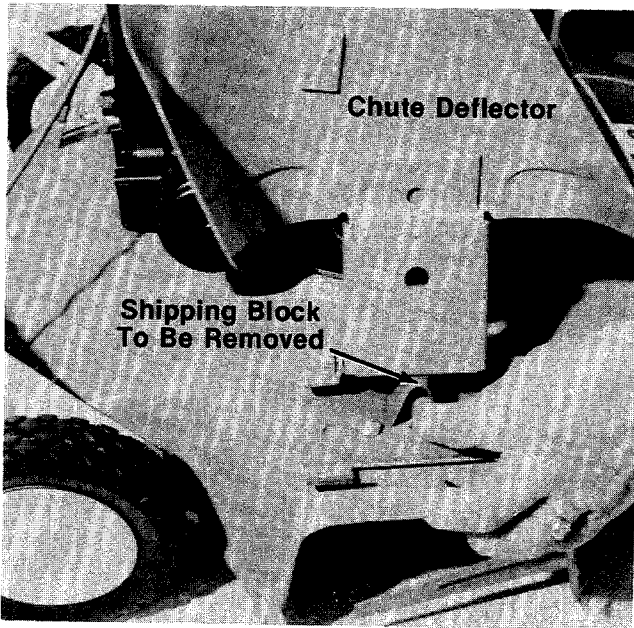

FIGURE 5.



Please note that the chute deflector on your mower is in an upright position. It is held in that position by a shipping block. This block is used for shipping purposes only. It must be removed and discarded before your mower is put into operation. See figure 5.

OPERATION

CAUTION
**DO NOT OPERATE
MOWER UNLESS
GUARD OR ENTIRE
GRASS CATCHER IS
IN ITS PROPER PLACE.**



FIGURE 6.

Keep hands and feet away from the chute area on cutting deck. See figure 6.



For shipping purposes your mower is set with the wheels in a low cutting height position. For best results raise the cutting position until it is determined which height is best for your lawn. See adjustment section.

1. **FILL SUMP WITH OIL** using a high quality detergent oil classified "For Service SC, SD, SE or MS." Nothing should be added to the recommended oil.

Use SAE 30 oil. If not available, use SAE 10W-30 or 10W-40 oil.

Place the engine level. Remove oil filler plug. **FILL THE OIL SUMP TO POINT OF OVERFLOW.** Pour slowly. Capacity 1¼ pints.

2. **FILL FUEL TANK** using clean, fresh, **regular** grade automotive gasoline. Fill tank completely!

DO NOT MIX OIL WITH GASOLINE.

3. When ready to start engine, place throttle control lever on handle in "START" position and start engine in accordance with instructions in engine manual. After engine starts, move throttle control lever on handle to desired engine speed. The engine is stopped by placing control lever on handle in the "STOP" position.
4. Be sure that lawn is clear of stones, sticks, wire, or other objects which could damage lawn mower or engine. For best results and to insure more even grass distribution, do not mow when lawn is excessively wet.



After striking a foreign object, stop the engine. Remove wire from spark plug, thoroughly inspect the mower for any damage, and repair the damage before restarting and operating the mower.

ADJUSTMENTS



Do not at any time make any adjustment to lawn mower without first stopping engine and disconnecting spark plug wire.

EASY CUTTING HEIGHT

An adjusting plate and thumb lever at each wheel position provides cutting height adjustment. Each adjusting plate has five holes. Height of cut will be changed when the thumb lever is moved from one hole to another. Simply depress thumb lever towards wheel and move wheel and lever assembly to desired position. All wheels must be placed in the same relative position.

HANDLE POSITION

The upper handle can be adjusted to a high or low position. The adjustment is made by removing the hex lock nuts and curved carriage bolts and reassembling in the other position. A ½" wrench is required. See figure 7.

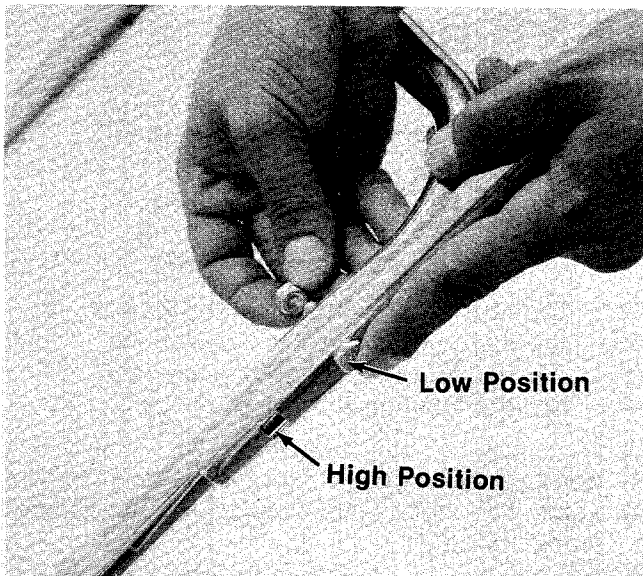

FIGURE 7.

THROTTLE

If adjustment becomes necessary, the throttle control wire assembly can be reset as follows:

1. Loosen, but do not remove, screw securing throttle control wire assembly at engine. See figure 8.
2. Move throttle control lever on handle to "FAST" position.
3. Move lever, to which control wire is fastened at engine, to full open position and retighten screw to secure throttle control wire assembly.

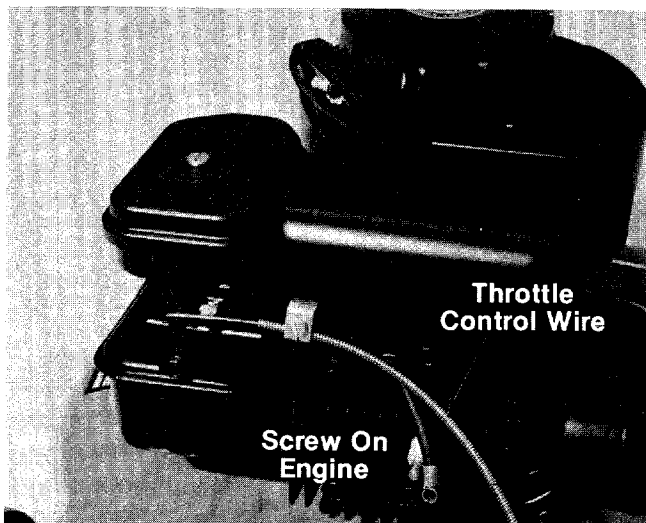

FIGURE 8.



WARNING

If any adjustments are made to the engine while the engine is running (e.g. carburetor), disengage all clutches and blades. Keep clear of all moving parts and be careful of heated surfaces and muffler.

CARBURETOR ADJUSTMENTS (See figure 9.)

Minor carburetor adjustment may be required to compensate for differences in fuel, temperature, altitude and load.

All carburetor adjustments should be made with the air cleaner on engine. Air cleaner mounting screw must be in carburetor when engine is run. Best adjustment is made with a fuel tank half full of gasoline.

To Adjust Carburetor:

1. Start engine and run long enough to warm it to operating temperature. If engine is out of adjustment so that it will not start, close the needle valve by turning it clockwise. Then open needle valve 1½ turns counterclockwise.
2. Move engine control to run engine at normal operating speed.
 - a. Turn needle valve in clockwise until engine starts to lose speed (lean mixture).
 - b. Then slowly turn needle valve out counterclockwise past the point of smoothest operation until engine just begins to run unevenly (rich mixture).
 - c. Turn needle valve back in clockwise very slowly till engine runs evenly.
 - d. Final adjustment of the needle valve should be slightly to the rich side (turn counterclockwise) of the mid-point.
3. Move engine control to "SLOW". Turn idle adjusting screw until a fast idle is obtained—(1750 R.P.M.).
4. To check adjustment, move engine control from "SLOW" to "FAST" speed. Engine should accelerate smoothly. If engine tends to stall or die out, increase idle speed or re-adjust carburetor, usually to a slightly richer mixture.

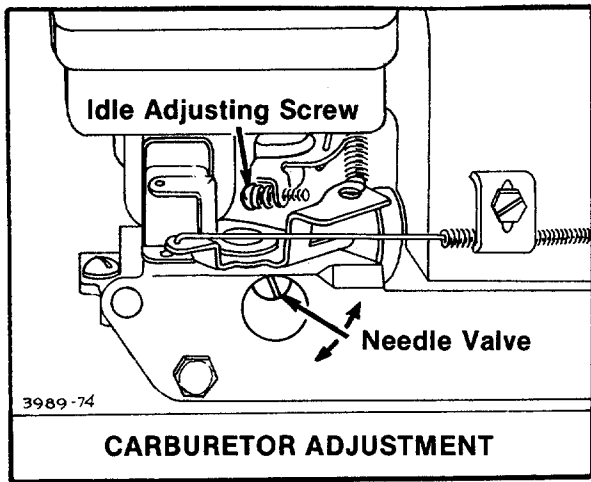

FIGURE 9.

LUBRICATION



IMPORTANT

Always stop engine and disconnect spark plug wire before cleaning, lubricating or doing any kind of work on lawn mower.

Wheels—Wheel bearings are of self-lubricating Fortiflex. They require no lubrication. However, if the wheels are removed for any reason, lubricate the surface of the axle bolt and the inner surface of the wheel with light oil. A 4 oz. plastic bottle of light oil lubricant is available. Order part number 737-0170. Engine oil may also be used.

If your unit is provided with optional ball bearing wheels, lubricate at least once a season with light oil.

Protective Shield—The pivot points on the protective shield should be lubricated periodically with light oil to prevent any rust or binding.

Chute Deflector—The torsion spring and pivot point should be lubricated periodically with light oil to prevent any rust or binding. Deflector must work freely.

Engine—Follow engine manual for lubrication instructions.

Throttle—Periodically lubricate throttle control lever and throttle wire assembly with a few drops of light oil for ease of operation.

MAINTENANCE

CUTTING BLADE

A. Removal for Sharpening or Replacement



Be sure to disconnect and ground the spark plug wire before working on the cutting blade to prevent accidental engine starting.

1. Remove the large bolt and lock washer which holds the blade and adapter to the engine crankshaft.
2. Remove the blade and adapter from the crankshaft. Be careful not to lose the key on the crankshaft.
3. If the blade or blade adapter needs replacing, remove the two small bolts, lock washers and nuts which hold the blade to the adapter.

B. Sharpening

Remove the cutting blade by following the directions of the preceding section.

When sharpening the blade, follow the original angle of grind as a guide. It is **extremely important** that each cutting edge receives an equal amount of grinding to prevent an unbalanced blade. An unbalanced blade will cause excessive vibration when rotating at high speeds and may cause damage to the mower.

The blade can be tested for balance by balancing it on a round shaft screwdriver. Remove metal from the heavy side until it balances evenly.



NOTE

It is recommended that the blade always be removed from the adapter for the best test of balance.

C. Reassembly

Before reassembling the blade and the blade adapter to the unit, lubricate the engine crankshaft and the inner surface of the blade adapter with light oil. Lubricating the bolt holes, bolts and inner surface of the nuts with light oil is also recommended. A 4 oz. plastic bottle of light oil lubricant is available. Order part number 737-0170. Engine oil may also be used.

When replacing the blade, be sure to install the blade with the side of the blade marked "Bottom" (or with part number) facing the ground when the mower is in the operating position. Make certain key is in place on the crankshaft.

Blade Mounting Torque

3/8" Dia. Bolt 375 in. lb. min., 450 in. lb. max.
 5/16" Dia. Bolt 150 in. lb. min., 250 in. lb. max.

To insure safe operation of your unit, ALL nuts and bolts must be checked periodically for correct tightness.

DECK

The underside of mower deck should be cleaned after each period of use as grass clippings, leaves, dirt and other matter will accumulate. This accumulation of grass clippings, etc., is undesirable as it will invite rust and corrosion and may cause an uneven discharge of grass clippings at the next cutting.

The deck may be cleaned by tilting the mower forward or on its side and scraping clean with a suitable tool or by washing with a stream of water from a garden hose.



CAUTION

Do not direct the stream of water at a hot engine as damage to the engine may result.

ENGINE OIL

CHECK OIL LEVEL before starting engine and after every 5 hours of operation.

ADD oil as necessary to keep level **FULL TO POINT OF OVERFLOWING.**

Before removing oil fill plug, clean area around plug to prevent dirt from entering oil fill hole.

Engine should be in a level position when checking oil.

CHANGE OIL after first 5 hours of operation. Thereafter change every 25 hours. Change oil while engine is warm. Oil may be drained thru drain on bottom of engine. To drain completely, always place engine level when draining thru the bottom. Oil capacity 1-1/4 pints. See figure 10.

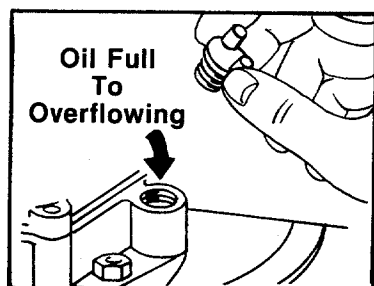

FIGURE 10.

AIR CLEANER

CLEAN AIR CLEANER and re-oil element every 25 hours under normal conditions. Clean every few hours under extremely dusty conditions. Poor engine performance and flooding usually indicates that the air cleaner should be serviced. See figure 11.

1. Remove screw.
2. Remove air cleaner carefully to prevent dirt from entering carburetor.
3. Take air cleaner apart and clean.
 - a. **WASH** foam element in kerosene or a liquid detergent and water to remove dirt.
 - b. **DRY** foam completely by wrapping and squeezing in a cloth.
 - c. **SOAK** foam with engine oil. Squeeze to distribute and remove excess oil.
4. Reassemble parts and fasten to carburetor.

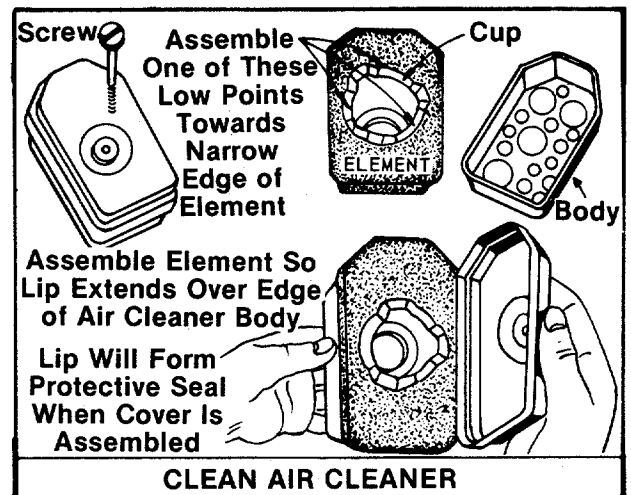

FIGURE 11.

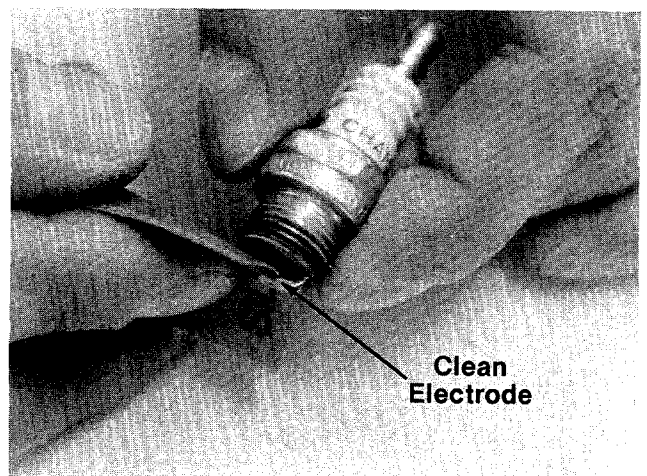

FIGURE 12.

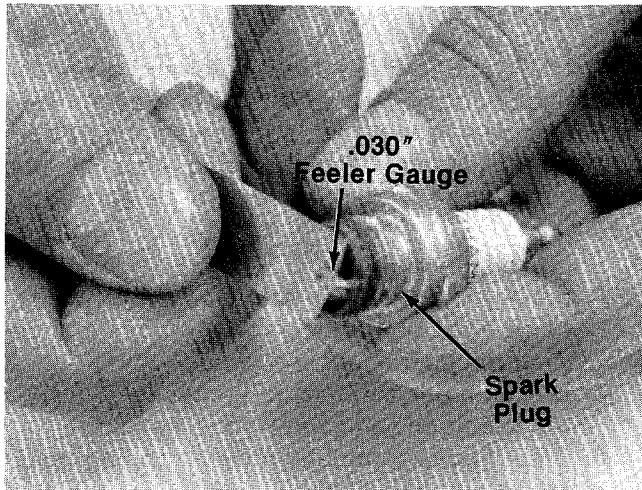

FIGURE 13.

SPARK PLUG

The spark plug should be cleaned (see figure 12) and the gap reset to a 0.030-inch clearance once a season (see figure 13). Spark plug replacement is recommended at the start of each mowing season; check engine manual for correct plug type.



Whenever the spark plug is removed for cleaning, it is advisable to replace the spark plug gasket with a new gasket.

USING YOUR ROTARY MOWER

For the best results do not cut wet grass because it tends to stick to the underside of the mower, thus preventing proper discharge of grass clippings. If wet grass must be cut, reduce walking speed to help distribute the clippings more effectively.

New grass should be treated as wet grass, otherwise a normal walking speed is about the right pace for efficient mowing.

The best mowing pattern is one that allows the clippings to discharge towards the uncut part of the lawn. This permits recutting of the clippings to further pulverize them. When cutting high weeds, discharge towards cut portion, then recut at right angles to first direction.

Lawn should be cut in the fall as long as there is growth.

OFF-SEASON STORAGE

The following steps should be taken to prepare lawn mower for storage.

1. Clean and lubricate mower thoroughly as described in the lubrication instructions.
2. Refer to Engine Manual for correct engine storage instructions.
3. Coat mower's cutting blade with chassis grease to prevent rusting.
4. Place blocks under deck to raise tires clear of floor.
5. Store mower in a dry, clean area.

HANDLE STORAGE

The handle may be placed in an upright position for storage.

Move the hairpin cotter to the outer hole on weld pins. See figure 1. Press inward on the bottom of the lower handle and push forward. The handle will lock in this position.

Reverse the above procedure to place the handle in the operating position.

 **NOTE**

The use of any accessory on this Rotary Mower other than those manufactured by the mower manufacturer is **not** recommended.

GRASS CATCHER Model No. 191-003A is available as optional equipment for the mowers shown in this manual.



1. The mower should not be operated without the entire grass catcher or chute deflector in place.
2. The mower should not be operated without the protective shield on the rear of the deck in place.

 **NOTE:**

Under normal usage bag material is subject to wear and should be checked periodically. Be sure any replacement bag complies with the mower manufacturer's recommendations.

For replacement bags, use only factory authorized replacement bag No. 764-0176.

111-112A 111-126A

IF YOU WRITE TO US ABOUT THIS ARTICLE
OR IF YOU ORDER REPLACEMENT PARTS AL-
WAYS MENTION THIS MODEL & SERIAL NO
MODEL

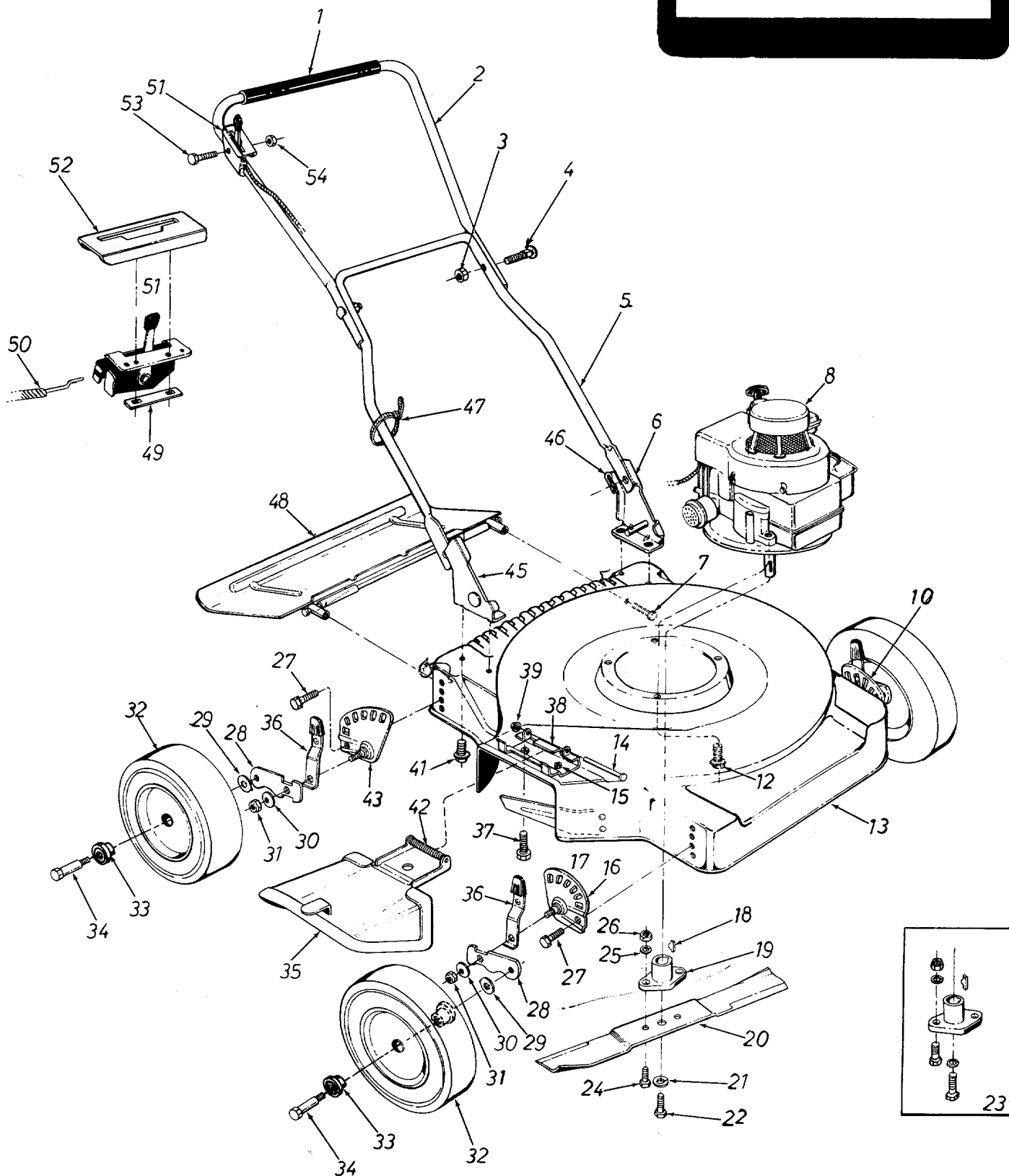

111-112A 111-126A

PARTS LIST FOR MODELS 111-112A AND 111-126A

REF. NO.	PART NO.	COLOR CODE	DESCRIPTION	NEW PART	REF. NO.	PART NO.	COLOR CODE	DESCRIPTION	NEW PART
1	718-0145		Grip		28	10937		Pivot Bar	
2	749-0384		Upper Handle		29	736-0105		Bell. Wash. 3/8" I.D.	
3	712-0158		Hex Cent. L-Nut 5/16-18 Thd.		30	736-0219		Bell. Wash. .400 I.D. x 1.130 O.D.	
4	710-0671		Curved Hd. Carr. Bolt 5/16-18 x 1.38		31	712-0116		Elastic Stopnut	
5	749-0373		Lower Handle		32	734-0876		Wheel Ass'y. Comp. (111-112A)	
6	12935		Handle Mount Brkt.—L.H.			734-0661		Wheel Ass'y. Comp. (111-126A)	
7	710-0567		Hex Bolt 1/4-28 x .62" Lg. Nylock		33	741-0262		Fortiflex Brg. (2 per wheel)	
8	3 H.P.		Engine (111-112A)		34	738-0102		Axle Bolt	
	3 1/2 H.P.		Engine (111-126A)		35	11679 —462		Chute Deflector Ass'y. Comp.	
10	10941		Height Adjuster Ass'y. Comp.—L.H.		36	14082		Spring Lever Ass'y. w/Knob	
12	710-0654		Hex Wash. Hd. Self-Tap Scr. 3/8-16 x 1.25" Lg.		37	710-0289		Hex Bolt 1/4-20 x .50" Lg.*	
13	11410 —462		20" Deck Ass'y. (111-112A)		38	11130 —462		Adapter Plate	
	11412 —462		22" Deck Ass'y. (111-126A)		39	726-0106		Push-On Flange Palnut	
14	711-0555		Pivot Pin		41	710-0600		Hex Wash. Hd. Self Tap Scr. 5/16-24 x .50" Lg.	
15	712-0107		Hex Cent. L-Nut 1/4-20 Thd.		42	732-0253		Torsion Spring	
16	10934		Index Plate Ass'y.—R.H.		43	10937		Index Plate Ass'y.—L.H.	
17	10938		Height Adjuster Ass'y. Comp.—R.H.		45	12936		Handle Mount Brkt.—R.H.	
18	714-0365		#6 Hi-Pro Key 5/32 x 5/8" Dia.		46	714-0104		Hairpin Cotter	
19	10769		Blade Adapter Kit		47	726-0188		Cable Tie—7/8"	
20	742-0123		20" Blade (111-112A)		48	11193 —462		Rear Shield Ass'y. (111-112A)	
	742-0125		22" Blade (111-126A)			14084 —462		Rear Shield Ass'y. (111-126A)	
21	736-0217		L-Wash. 3/8" Scr.—H.D.		49	726-0134		Speed Nut #8-32—Twin Type	
22	710-0459		Hex Bolt 3/8-24 x 1.50" Lg.—H.T.		50	746-0229		Conduit and Wire	
23	10769		Blade Adapter Kit		51	746-0202		Throttle Control Ass'y. Comp.	
24	710-0117		Hex Bolt 5/16-24 x 1.00" Lg.—H.T.		52	731-0344		Plastic Throttle Control Cover	
25	736-0119		L-Wash. 5/16" Scr.*		53	710-0606		Hex Bolt 1/4-20 x 1.50" Lg.*	
26	712-0123		Hex Nut 5/16-24 Thd.*		54	712-0107		Hex Cent. L-Nut 1/4-20 Thd.	
27	710-0209		Hex Sems Bolt 3/8-16 x .62" Lg.*						

(462—Red Flake)

*For faster service obtain standard nuts, bolts and washers locally. If these items cannot be obtained locally, order by part number and size as shown on parts list.

When ordering parts, if color or finish is important use the appropriate color code shown above (e.g. Red Flake Finish—11409 (462).)

The engine is not under warranty by the mower manufacturer. If repairs or service is needed on the engine, please contact your nearest authorized engine service outlet. Check the "Yellow Pages" of your telephone book under "Engines — Gasoline."



NOTE

This instruction manual covers various models and all specifications shown do not necessarily apply to your model. Specifications subject to change without notice or obligation.

PARTS INFORMATION

POWER EQUIPMENT PARTS AND SERVICE

Parts and service for all MTD manufactured power equipment are available through the authorized service firms listed below. All orders should specify the model number of your unit, part numbers, description of parts and the quantity of each part required.

NOTE: If any parts are found to be missing or defective upon assembly of this unit, write to advise the factory so that immediate replacement can be made.

ALABAMA	BIRMINGHAM
Auto Electric & Carburetor Co.	2625 4th Ave. S. 35233
ARKANSAS	FORT SMITH
Mity Mite Motors, Inc.	4515 S. 16th St. 72901
Sutton's Lawn Mower Shop	NORTH LITTLE ROCK
CALIFORNIA	Rt. 4, Box 368 72117
BILLIOUS	PORTERVILLE
J.W. Jewett Co.	75 North D Street 93257
COLORADO	SAN FRANCISCO
Colorado Outdoor Power Equip.	981 Folsom St. 94107
FLORIDA	DENVER
Radco Distributors	527 West Evans 80223
Small Eng. Dist.	JACKSONVILLE
GEORGIA	4909 Victor St. 32207
East Point Cycle & Key	Box 5459
ILLINOIS	2351 N.W. 147th St. 33054
Keen Edge Co.	EAST POINT
INDIANA	2834 Church St. 30344
Parts & Sales Inc.	LYONS
IOWA	8615 Ogden Ave. 60534
Power Lawn & Garden Equip.	ELKHART
LOUISIANA	2101 Industrial Pkwy. 46514
Suhren Engine Co.	DUBUQUE
MARYLAND	2551 J.F. Kennedy 52001
Center Supply Co.	NEW ORLEANS
MASSACHUSETTS	8330 Earhart Blvd. 70118
Morton B. Collins Co.	TAKOMA PARK
MICHIGAN	6867 New Hampshire Ave. 20012
Lorenz Service Co.	SPRINGFIELD
Power Equipment Dist.	300 Birnie Ave. 01107
MINNESOTA	LANSING
Hance Distributing Inc.	2500 S. Pennsylvania 48910
MISSISSIPPI	MOUNT CLEMENS
Biloxi Sales & Service, Inc.	36463 South Gratiot 48043
MISSOURI	HOPKINS
Automotive Equip. Service	420 Excelsior Ave. W. 55343
Ross-Frazier Supply Co.	BILOXI
Henzler, Inc.	506 Caillavet St. 39533
NEW JERSEY	KANSAS CITY
Lawnmower Parts Inc.	3117 Holmes St. 64109
Feld Distributor	ST. JOSEPH
NEW YORK	8th and Monterey 64503
Gamble Dist., Inc.	ST. LOUIS
	2015 Lemay Ferry Road 63125
	BELLMAR
	717 Creek Rd. 08030
	RUTHERFORD
	28 Glen Rd. 07070
	CARTHAGE
	West End Ave. 13619

BRIGGS AND STRATTON, TECUMSEH AND PEERLESS PARTS AND SERVICE

Briggs & Stratton, Tecumseh and Peerless parts and service should be handled by your nearest authorized engine service firm. Check the yellow pages of your telephone directory under the listing **Engines—Gasoline**, Briggs & Stratton or Tecumseh Lauson.

NORTH CAROLINA	GOLDSBORO
Smith Hardware Co.	515 N. George St. 27530
Dixie Sales Company	GREENSBORO
OHIO	335 N. Green 27402
Stebe's Mid-State Mower Supply	CARROLL
Bleckrie, Inc.	Box 366, 71 High St. 43112
National Central	CLEVELAND
Burton Supply Co.	7900 Lorain Ave. 44102
OKLAHOMA	WADSWORTH
Victory Motors, Inc.	687 Seville Rd. 44281
Forest Sales Inc.	YOUNGSTOWN
OREGON	1301 Logan Ave. 44501
Kenton Supply Co.	MUSKOGEE
PENNSYLVANIA	605 S. Cherokee 74401
Stull Equipment Corp.	OKLAHOMA CITY
EECO Inc.	6415 N. Olie 73116
Thompson Rubber Co.	PORTLAND
Bluemon Co.	8216 N. Denver Ave. 97217
Frank Roberts & Sons	CHESTER
TENNESSEE	742 W. Front St. 19013
Master Repair Service	HARRISBURG
American Sales & Service, Inc.	4021 N. 6th St. 17110
TEXAS	PHILADELPHIA
Marr Brothers, Inc.	5222-24 N. Fifth St. 19120
Woodson Sales Corp.	PITTSBURGH
Bullard Supply Co.	11125 Frankstown Rd. 15235
Catto & Putty, Inc.	PUNXSUTAWNEY
UTAH	R.D. 2 15767
A-1 Engine & Mower Co.	KNOXVILLE
VERMONT	2000 Western Ave. 37921
Vermont Hdwe. Co. Inc.	MEMPHIS
VIRGINIA	1922 Lynnbrook 38116
RBI Corp.	DALLAS
WASHINGTON	423 E. Jefferson 75203
Bailey's Inc.	FORT WORTH
WEST VIRGINIA	1702 N. Sylvania 76111
Young's, Inc.	HOUSTON
WISCONSIN	2409 Commerce St. 77003
Power Pac	SAN ANTONIO
	414 Live Oak 78298
	SALT LAKE CITY
	437 E. 9th St. 84111
	BURLINGTON
	180 Flynn Ave. 05401
	RICHMOND
	963 Myers St. 23260
	SEATTLE
	1414 14th Ave. 98102
	CHARLESTON
	233 Virginia St., E. 25301
	MARSHFIELD
	301 E. 29th St. 54449

WARRANTY PARTS AND SERVICE POLICY

The purpose of warranty is to protect the customer from defects in workmanship and materials, defects which are NOT detected at the time of manufacture. It does not provide for the unlimited and unrestricted replacement of parts. Use and maintenance are the responsibility of the customer. The manufacturer cannot assume responsibility for conditions over which it has no control. Simply put, if it's the manufacturer's fault, it's the manufacturer's responsibility; if it's the customer's fault, it's the customer's responsibility.

CLAIMS AGAINST THE MANUFACTURER'S WARRANTY INCLUDES:

1. Replacement of Missing Parts on new equipment.
2. Replacement of Defective Parts within the warranty period.
3. Repair of Defects within the warranty period.

All claims MUST be substantiated with the following information:

1. Model Number of unit involved.
2. Date unit was purchased or first put into service.
3. Date of failure.
4. Nature of failure.