



OWNER'S GUIDE



Model Series

070 Thru 088

20" And 22"

Rotary Mowers



IMPORTANT: READ SAFETY RULES AND INSTRUCTIONS CAREFULLY

Warning: This unit is equipped with an internal combustion engine and should not be used on or near any unimproved forest-covered, brush-covered or grass-covered land unless the engine's exhaust system is equipped with a spark arrester meeting applicable local or state laws (if any). If a spark arrester is used, it should be maintained in effective working order by the operator. In the State of California the above is required by law (Section 4442 of the California Public Resources Code). Other states may have similar laws. Federal laws apply on federal lands. A spark arrester for the muffler is available through your nearest engine authorized service dealer or contact the service department, P.O. Box 368022 Cleveland, Ohio 44136-9722.

MTD PRODUCTS INC. P.O. BOX 368022 CLEVELAND, OHIO 44136-9722

IMPORTANT SAFE OPERATION PRACTICES



This symbol points out important safety instructions which, if not followed, could endanger the personal safety and/or property of yourself and others. Read and follow all instructions in this manual before attempting to operate your lawn mower.

Failure to comply with these instructions may result in personal injury. When you see this symbol-heed its warning.



DANGER:

Your lawn mower was built to be operated according to the rules for safe operation in this manual. As with any type of power equipment, carelessness or error on the part of the operator can result in serious injury. This lawn mower is capable of amputating hands and feet and throwing objects. Failure to observe the following safety instructions could result in serious injury or death.

1. GENERAL OPERATION

1. Read this owner's guide carefully in its entirety before attempting to assemble this machine. Read, understand, and follow all instructions on the machine and in the manual(s) before operation.
2. Be completely familiar with the controls and the proper use of this machine before operating it.
3. Keep this manual in a safe place for future and regular reference and for ordering replacement parts.
4. Your rotary mower is a precision piece of power equipment, not a plaything. Therefore, exercise extreme caution at all times.
5. Your unit has been designed to perform one job: to mow grass. Do not use it for any other purpose.
6. Never allow children under 14 years old to operate a power mower. Children 14 years old and over should only operate mower under close parental supervision.
7. Only responsible individuals who are familiar with these rules of safe operation should be allowed to use your mower.
8. Keep the area of operation clear of all persons, particularly small children and pets. Stop engine when they are in the vicinity of your mower to help prevent blade contact or thrown object injury.
9. Although the area of operation should be completely cleared of foreign objects, an object may have been overlooked and could be accidentally thrown by the mower in any direction and cause serious personal injury to the operator or any others allowed in the area.
10. Thoroughly inspect the area where the equipment is to be used. Remove all stones, sticks, wire, bones, toys and other foreign objects which could be picked up and thrown by the mower in any direction and cause serious personal injury to the operator or any others allowed in the area.
11. Plan your mowing pattern to avoid discharge of material toward roads, sidewalks, bystanders and the like.
12. To help avoid a thrown objects injury, keep children, bystanders and helpers at least 75 feet from the mower while it is in operation.
13. Always wear safety glasses or safety goggles during operation or while performing an adjustment or repair, to protect eyes from foreign objects that may be thrown from the machine in any direction.
14. Wear sturdy, rough-soled work shoes and close-fitting slacks and shirts. Shirts and pants that cover the arms and legs and steel-toed shoes are recommended. Do not wear loose fitting clothes or jewelry. They can be caught in moving parts. Never operate a unit in bare feet, sandals, or sneakers.
15. Do not put hands or feet near or under rotating parts.
16. Keep clear of discharge opening at all times as the rotating blade can cause injury.
17. Many injuries occur as a result of the mower being pulled over the foot during a fall. Do not hang on to the mower if you are falling; release the handle immediately.
18. Never pull the mower toward you while you are walking. If you must back the mower away from a wall or obstruction, first look down and behind, and then follow these steps:
 - Step back from the mower to fully extend your arms.
 - Be sure you are well balanced with sure footing.
 - Pull the mower back slowly, no more than half way toward you.
 - Repeat these steps as needed.
19. Do not operate the mower while under the influence of alcohol or drugs.
20. Disengage the self-propelled mechanism or drive clutch on units so equipped before starting the engine.
21. The blade control handle is a safety device. Never attempt to bypass its operation. Doing so makes

the safety device inoperative and may result in personal injury through contact with the rotating blade. The blade control handle must operate easily in both directions and automatically return to the disengaged position when released.

22. Never operate the mower in wet grass. Always be sure of your footing. A slip and fall can cause serious personal injury. Keep a firm hold on the handle and walk, never run. Mow only in daylight or in good artificial light.
23. Stop the blade when crossing gravel drives, walks or roads.
24. If the equipment should start to vibrate abnormally, stop the engine and check immediately for the cause. Vibration is generally a warning of trouble.
25. Shut the engine off and wait until the blade comes to a complete stop before removing the grass catcher or unclogging the chute. The cutting blade continues to rotate for a few seconds after the engine is shut off. Never place any part of the body in the blade area until you are sure the blade has stopped rotating.
26. Never operate mower without proper guards, grass catcher, plates or other safety protective devices in place.
27. Muffler and engine become hot and can cause a burn. Do not touch.
28. Only use accessories approved for this machine by the manufacturer. Read, understand, and follow all instructions provided with the approved accessory.
29. If situations occur which are not covered in this manual, use care and good judgment. Contact your dealer for assistance.

2. SLOPE OPERATION

For your safety, use the slope gauge included as part of this manual to measure slopes before operating this unit on a sloped or hilly area. If the slope is greater than 15, as shown on the slope gauge, do not operate this unit on that area or serious injury could result.

DO:

- Mow across the face of slopes; never up and down. Exercise extreme caution when changing direction on slopes.
- Watch for holes, ruts, hidden objects, or bumps. Tall grass can hide obstacles.
- Always be sure of your footing. A slip and fall can cause serious personal injury.

DO NOT:

- Do not mow near drop-offs, ditches or embankments. The operator could lose footing or balance.

- Do not mow slopes greater than 15 as shown on the slope gauge.
- Do not mow on wet grass. Reduced footing could cause slipping.

3. CHILDREN









1. Tragic accidents can occur if the operator is not alert to the presence of children. Children are often attracted to the mower and the mowing activity. Never assume that children will remain where you last saw them.
2. Keep children out of the mowing area and under the watchful care of a responsible adult other than the operator.
3. Be alert and turn mower off if a child enters the area.
4. Before and while moving backwards, look behind and down for small children.
5. Never allow children under age 14 to operate the mower.
6. Use extreme care when approaching blind corners, shrubs, trees, or other objects that may obscure your vision of a child or hazard.

4. SERVICE

1. Use extreme care in handling gasoline and other fuels. They are extremely flammable and the vapors are explosive.
 - Use only an approved container.
 - Never remove gas cap or add fuel while the engine is running. Allow engine to cool at least two minutes before refueling.
 - Replace gasoline cap securely and wipe off any spilled gasoline before starting the engine as it may cause a fire or explosion.
 - Extinguish all cigarettes, cigars, pipes and other sources of ignition.
 - Never refuel machine indoors because flammable vapors will accumulate in the area.
 - Never store the machine or fuel container inside where there is an open flame or spark such as a gas water heater, space heater, or furnace.
2. Never run an engine inside a closed area.
3. To reduce fire hazard, keep mower free of grass, leaves, or other debris build-up. Clean up oil or fuel spillage. Allow mower to cool at least 5 minutes before storing.
4. Before cleaning, repairing, or inspecting, make certain the blade and all moving parts have stopped. Disconnect the spark plug wire, and keep the wire away from the spark plug to prevent accidental starting.

5. Check the blade and engine mounting bolts at frequent intervals for proper tightness. Also, visually inspect blade for damage (e.g., bent, cracked). Replace with blade which meets original equipment specifications.
6. Keep all nuts, bolts, and screws tight to ensure the equipment is in safe working condition.
7. Never tamper with safety devices. Check their proper operation regularly.
8. After striking a foreign object, stop the engine, remove the wire from the spark plug, and thoroughly inspect the mower for any damage. Repair the damage before starting and operating the mower.
9. Never attempt to make a wheel or cutting height adjustment while the engine is running.
10. Grass catcher components are subject to wear, damage and deterioration, which could expose moving parts or allow objects to be thrown. For safety protection, frequently check components and replace with manufacturer's recommended parts, when necessary.
11. Mower blades are sharp and can cut. Wrap the blade(s) or wear gloves, and use extra caution when servicing them.
12. Do not change the engine governor setting or overspeed the engine. Excessive engine speeds are dangerous.

These symbols may be on your lawn mower unit. Understand and follow them.

	Fast		Choke OFF		Ignition Key
	Slow		Choke		Insert to run
			Choke FULL		Remove to stop

These safety labels are on your lawn mower unit. Please follow the instruction on these labels and maintain safety.





LIMITED PARTS LIST

Following is a limited, illustrated breakdown (with part numbers) of some parts and accessories available for your lawn mower. To place order for any of the parts mentioned here and/or other parts, accessories and service information for your lawn mower, please call 1(800) 800-7310. Please have the exact **model number** and the **serial number** of your lawn mower available when you call. You can locate these numbers on the deck at the rear of the unit. You must have these numbers, along with the date of purchase, in order to receive warranty or service.

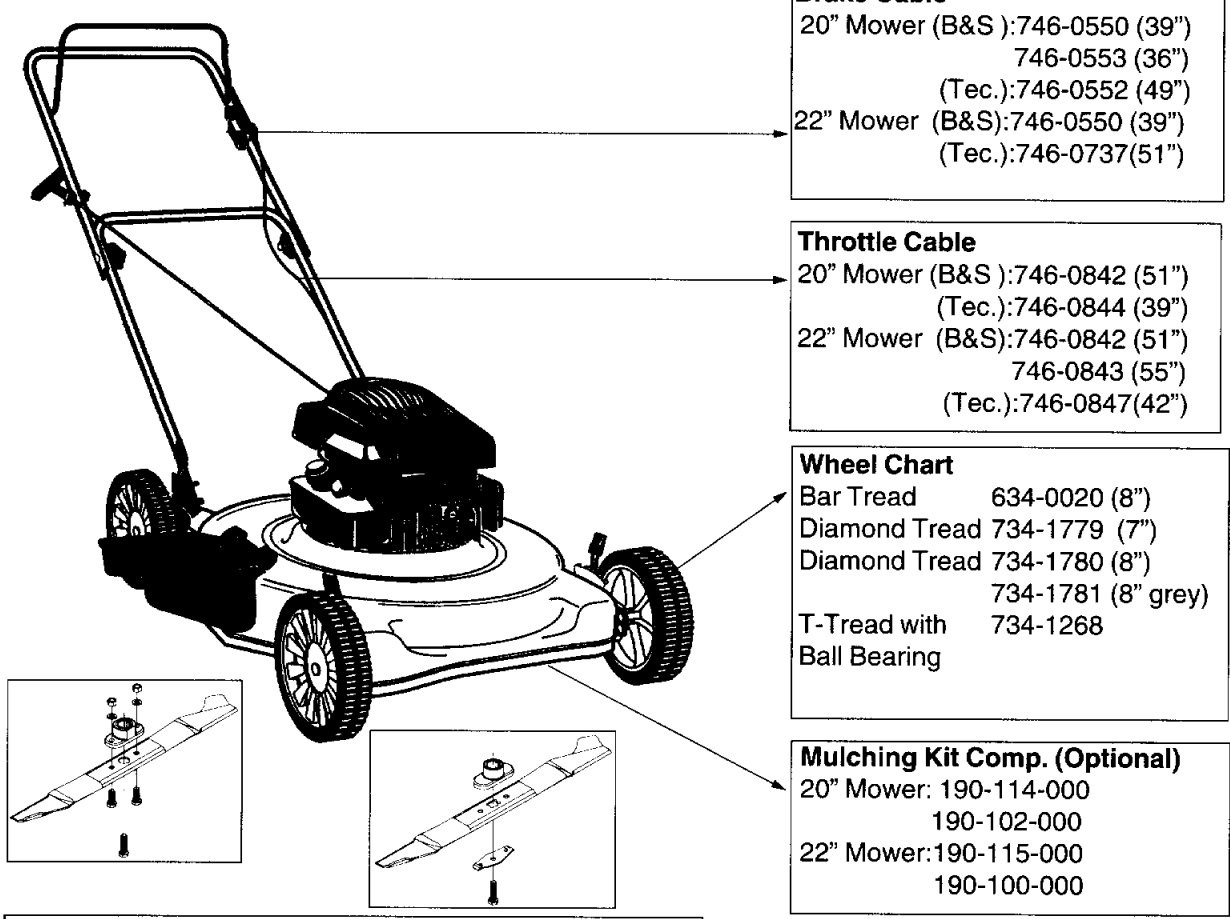

Brake Cable
 20" Mower (B&S):746-0550 (39")
 746-0553 (36")
 (Tec.):746-0552 (49")
 22" Mower (B&S):746-0550 (39")
 (Tec.):746-0737(51")

Throttle Cable
 20" Mower (B&S):746-0842 (51")
 (Tec.):746-0844 (39")
 22" Mower (B&S):746-0842 (51")
 746-0843 (55")
 (Tec.):746-0847(42")

Wheel Chart

Bar Tread	634-0020 (8")
Diamond Tread	734-1779 (7")
Diamond Tread	734-1780 (8")
	734-1781 (8" grey)
T-Tread with	734-1268
Ball Bearing	

Mulching Kit Comp. (Optional)
 20" Mower: 190-114-000
 190-102-000
 22" Mower:190-115-000
 190-100-000

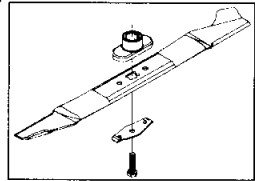
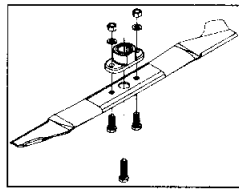

Blade Adapter Kit
 20" Mower: 753-0588 (secured by one bolt)
 753-0484 (secured by three bolts)
 22" Mower: 753-0588 (secured by one bolt)
 753-0484 (secured by three bolts)

Blade
 20" Mower: 742-0640 (secured by one bolt)
 742-0620 (secured by three bolts)
 22" Mower: 742-0642 (secured by one bolt)
 742-0622 (secured by three bolts)

Mulching Blade (Optional)
 20" Mower: 742-0740 (secured by one bolt)
 742-0720 (secured by three bolts)
 22" Mower: 742-0742 (secured by one bolt)
 742-0722 (secured by three bolts)

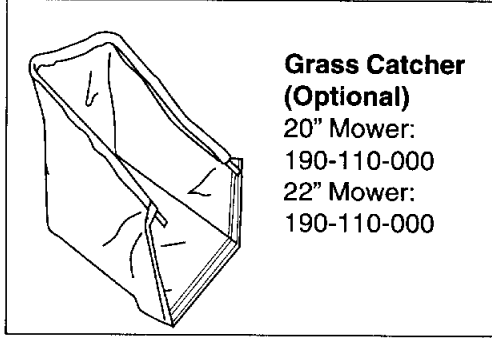

Grass Catcher (Optional)
 20" Mower:
 190-110-000
 22" Mower:
 190-110-000

ASSEMBLY

YOUR RESPONSIBILITY

Restrict the use of this power machine to persons who read, understand and follow the warnings and instructions in this manual and on the machine.

1. UNPACKING

Remove staples, break glue on top flaps, or cut tape at carton end and peel along top flap to open carton.

Remove loose parts if included with unit (i.e., owner's manual, etc.).

Cut along dotted lines and lay carton down flat.

Remove packing material.

Roll or slide unit out of carton. Check carton thoroughly for loose parts.

2. TOOLS REQUIRED

Pair of Pliers (Not necessary, but helpful).

3. SETTING UP LAWN MOWER

a. Disconnect spark plug wire

Before setting up your lawn mower, disconnect the spark plug wire from the spark plug, and ground it against the engine. See figure 1.

NOTE: On engines with a rubber boot, attach rubber boot to a bolt on the engine to ground.

This owner's guide covers various models of mowers. **Follow only those instructions which pertain to your unit.**

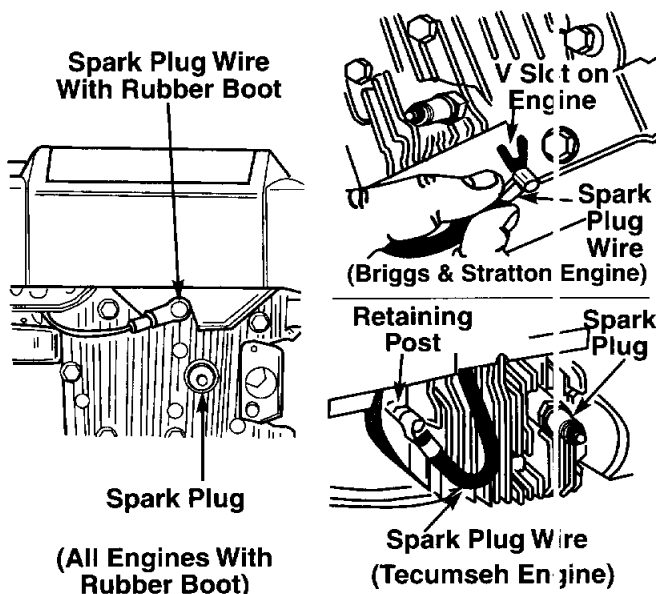

Figure 1

NOTE: Reference to right or left hand side of the mower is observed from the operating position. This unit is shipped WITHOUT GASOLINE or OIL in the engine. Be certain to service engine with gasoline and oil before operating your mower.

b. Assembling handle

- Remove any packing material which may be between the upper and lower handles for shipping purposes.
- Pull up and back on the upper handle to raise the handle into the operating position, making sure not to crimp the cables. Make certain the lower handle is seated securely into the handle mounting brackets.
- Tighten the hand knobs on each side of the handle (carriage bolts must be seated properly into the handle).

NOTE: Your mower is shipped with the handle in the higher height position. If you wish to lower the height of the handle, refer to the Adjustment Section at this time.

- Remove the hairpin clips from the outer hole in the weld pins on the handle mounting brackets. See figure 2.
- Using a pair of pliers, squeeze one leg of the lower handle against the handle mounting bracket. See figure 2.

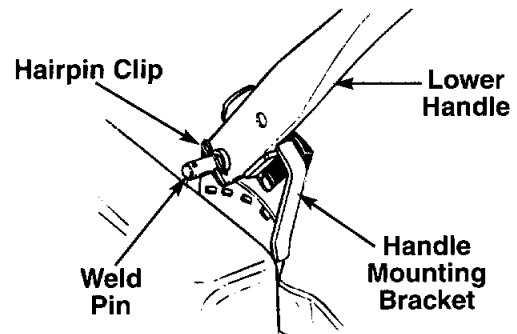

Figure 2

- Insert the hairpin clip into the inner hole on the weld pin. Repeat on other side. See figure 2.
- Loosen the wing nut which secures the rope guide to the right side of upper handle. See figure 3.

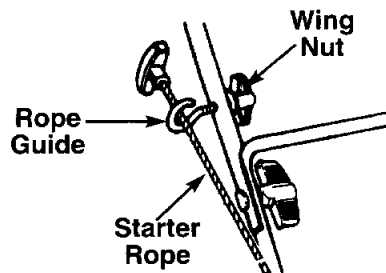

Figure 3

- With the spark plug wire disconnected and grounded, hold the blade control handle against the upper handle, and pull the starter rope out of the engine.
- Release the blade control handle.
- Slip the starter rope into the rope guide.
- Tighten the wing nut.

c. Setting up chute deflector (Figure 4)

The chute deflector on your mower is held in an upright position by a retainer for shipping purposes only. To remove this retainer, move the spring-loaded chute toward the engine by pushing above the retainer. Remove the retainer and carefully lower the chute into operating position keeping fingers out of the way.

WARNING: The chute retainer, used for shipping, must be removed and discarded before operating the mower.

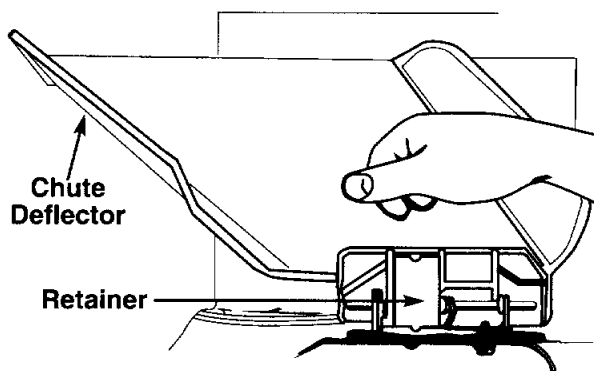

Figure 4

d. Optional mulching baffle (Figure 5)

A mulching kit is available for the mowers shown in this manual. To obtain a mulching kit, refer to the back cover of this manual.

If your mower is equipped with the optional mulching baffle, install as follows.

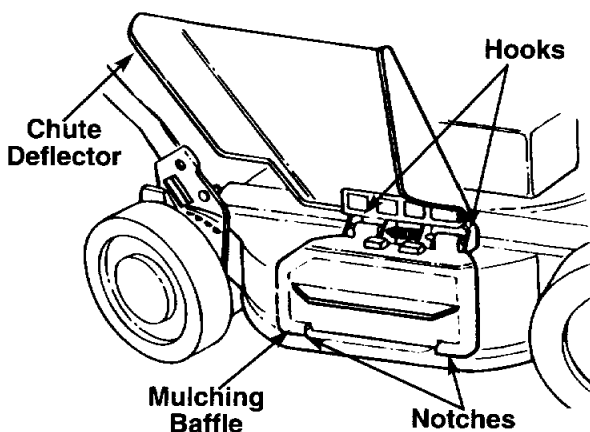

Figure 5

- Lift the chute deflector on the mower. Slide the notches in the bottom of the mulching baffle over the lip of the discharge opening. See figure 3.
- Push the hooks on the top of the baffle until they snap over the hinge on the discharge chute. Release the chute deflector.

e. Final assembly

Make certain all nuts and bolts are tightened securely.

CONTROLS

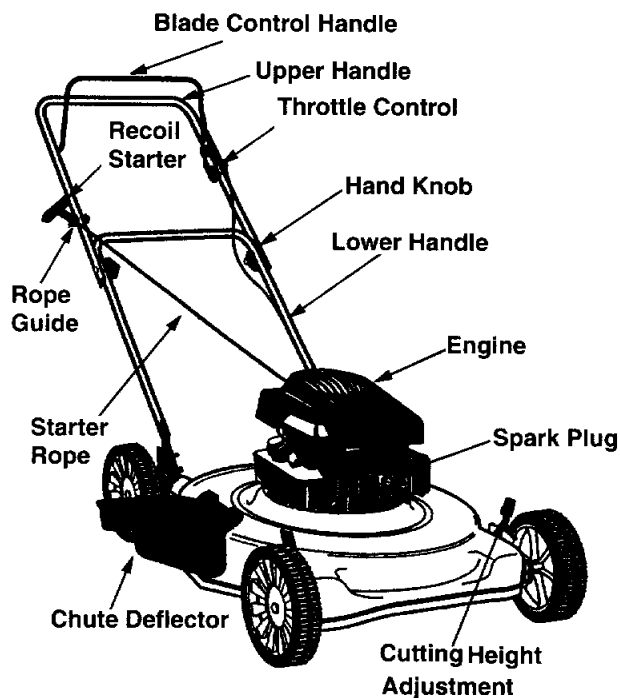

Figure 6

1. BLADE CONTROL HANDLE



WARNING: This control mechanism is a safety device. Never attempt to bypass its operations. The blade will rotate whenever the engine is running.

The blade control handle is located on the upper handle of the mower. See figure 6. The blade control handle must be depressed in order to operate the unit. Release the blade control handle to stop the engine and blade.

2. THROTTLE CONTROL

The throttle control is located on the side of the upper handle. It is used to regulate the engine speed.



WARNING: The throttle control cannot be used to stop the engine.

3. RECOIL STARTER

The recoil starter is attached to the handle and is used to start the engine. See figure 6.

OPERATION



WARNING: Keep hands and feet away from the chute area on cutting deck.

The operation of any lawn mower can result in foreign objects being thrown into the eyes, which can result in severe eye damage. Always wear safety glasses or eye shields. We recommend wide vision safety mask for over spectacles or standard safety glasses.

1. GAS AND OIL FILL-UP

Service the engine with gasoline and oil as instructed in the separate engine manual packed with your mower. Read instructions carefully.



WARNING: Never fill fuel tank indoors, with engine running or until the engine has been allowed to cool for at least two minutes after running.

2. TO START ENGINE AND ENGAGE BLADE

- Attach spark plug wire to spark plug. If unit is equipped with a rubber boot over the end of the spark plug wire, make certain the metal cap on the end of the spark plug wire (inside the rubber boot) is fastened securely over the metal tip on the spark plug.
- Move throttle control lever all the way forward.
- If unit is equipped with a primer, prime engine as instructed in engine manual.
- Standing behind the unit, depress the blade control handle and hold it against the upper handle as shown. See figure 7.

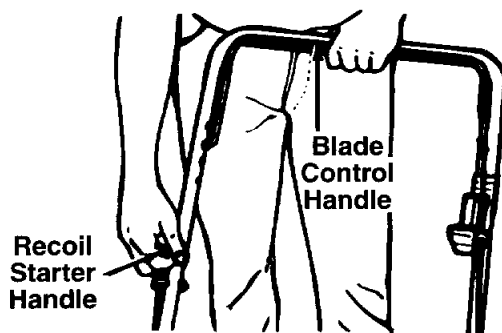

Figure 7

- Grasp starter handle and pull rope out slowly until engine reaches start of compression cycle (rope will pull slightly harder at this point). Let the rope rewind slowly.
- Pull rope with a rapid, continuous, full arm stroke. Keep a firm grip on starter handle. Return it slowly to the rope guide.
- After engine starts, move throttle control to desired engine speed. (Mower is designed to operate at full throttle.)

NOTE: If any problems are encountered, refer to the Trouble Shooting Guide on page 13.

3. TO STOP ENGINE AND BLADE

- Release the blade control handle to stop the engine and blade.



WARNING: The blade continues to rotate for a few seconds after the engine is shut off.

- Disconnect the spark plug wire and ground it against the engine to prevent accidental starting while equipment is unattended.



4. USING YOUR ROTARY MOWER

Be sure that lawn is clear of stones, sticks, wire, or other objects which could damage lawn mower or engine. Such objects could be accidentally thrown by the mower in any direction and cause serious personal injury to the operator and others.

Operating Tips

Raise the cutting position until it is determined which height is best for your lawn. See cutting height adjustment section.

Do not cut wet grass because it tends to stick to the underside of the mower, preventing proper discharge of grass clippings, and could cause you to slip and fall. New grass, thick grass or wet grass may require a narrower cut. Blade speed should be adjusted to the condition of the lawn.

The best mowing pattern is one that allows the clippings to discharge towards the uncut part of the lawn. This permits recutting of the clippings to further pulverize them.

When cutting high weeds, discharge towards cut portion, then recut at right angles to first direction. For a healthy lawn, never cut more than one-third of the total length of the grass at any one cutting. Lawn should be cut in the fall as long as there is growth.

This mower is designed to be operated at full throttle to give you the best cut and do the most effective job of bagging the cut grass.



WARNING: If you strike a foreign object, stop the engine. Remove wire from spark plug, thoroughly inspect the mower for any damage, and repair the damage before restarting and operating the mower. Extensive vibration of the mower during operation is an indication of damage. The unit should be promptly inspected and repaired.

ADJUSTMENTS



WARNING: Do not at any time make any adjustment to lawn mower without first stopping engine and disconnecting spark plug wire.

1. CUTTING HEIGHT ADJUSTMENT

Each wheel is equipped with an adjusting plate and thumb lever to adjust the cutting height. Each adjusting plate has nine height positions. You can change the cutting height by moving the thumb lever to any of these nine positions.

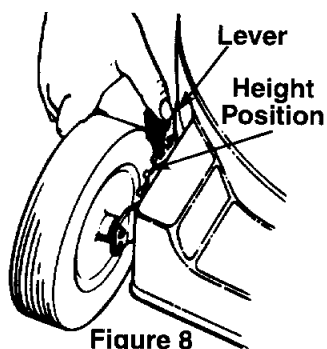

- Depress the lever towards the wheel and move the wheel and lever assembly to desired position.
- Place all four wheels in the same relative position. See figure 8.

2. HANDLE HEIGHT ADJUSTMENT

Your mower is shipped with the handle in the higher height position. To lower the handle height, proceed as follows.

- Remove the starter rope from the rope guide.
- Remove the upper handle by removing the hand knobs and carriage bolts. Lay the upper handle out of the way, being careful not to bend or kink the cables.

- Remove the hairpin clips from the weld pins on the handle brackets. Press inward on the legs of the lower handle and remove it from the mower.
- Turn the lower handle around so the notches on the bottom of the lower handle are facing forward as shown in figure 9.
- Reassemble placing the bottom holes in the handle over the weld pins in the handle mounting bracket.
- Reassemble the upper handle.
- Place hairpin clips in the inner holes in the weld pins and attach the starter rope as instructed in the Set-Up Instructions.

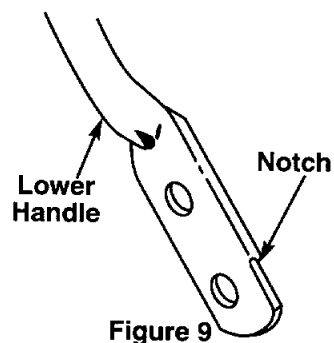

3. THROTTLE CONTROL ADJUSTMENT

If the throttle control requires adjustment or if it has been replaced, adjust the throttle control as follows.

- Remove the screw shown in figure 10. Remove the cable clamp from the cable.

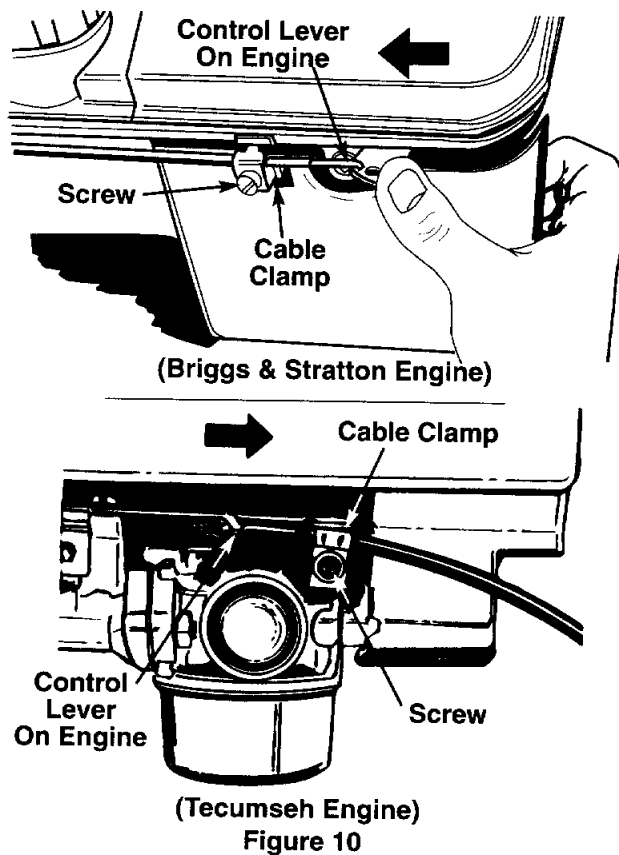

NOTE: If you have a Tecumseh engine, simply loosen the screw shown in figure 9 so the cable will move freely beneath the clamp. It is not necessary to remove the screw and clamp completely.

- Push the throttle control lever on the handle all the way forward as far as it will go, then back it off one "click". Make certain the throttle control lever remains in this position.
- Push the control lever on the engine as far toward the rear of the engine as it will go.
- Secure the cable in this position with the cable clamp and screw.

4. CARBURETOR ADJUSTMENT



WARNING: If any adjustments are made to the engine while the engine is running (e.g. carburetor), keep clear of all moving parts. Be careful of heated surfaces and muffler.

Minor carburetor adjustments may be required to compensate for differences in fuel, temperature, altitude and load. To adjust carburetor, refer to the separate engine manual packed with your mower.

NOTE: A dirty air cleaner will cause an engine to run rough. Be certain air cleaner is clean and attached to the carburetor before adjusting carburetor.

LUBRICATION



WARNING: Always stop engine and disconnect spark plug wire before cleaning, lubricating or doing any kind of work on lawn mower.

a. Blade Control

- Lubricate the pivot points on the blade control handle and the brake cable at least once a season with light oil. See figure 11. The blade control must operate freely in both directions.

b. Chute Deflector

- Lubricate the torsion spring and pivot point periodically with light oil to prevent any rust or binding. Make sure that the deflector works freely. See figure 11.

c. Wheels

- Mower may be provided with ball bearing wheels.

Lubricate at least once a season with light oil (or engine oil).

- Also, if the wheels are removed for any reason, lubricate the surface of the axle bolt and the inner surface of the wheel. See figure 11.

d. Engine

Follow engine manual for lubrication instructions.

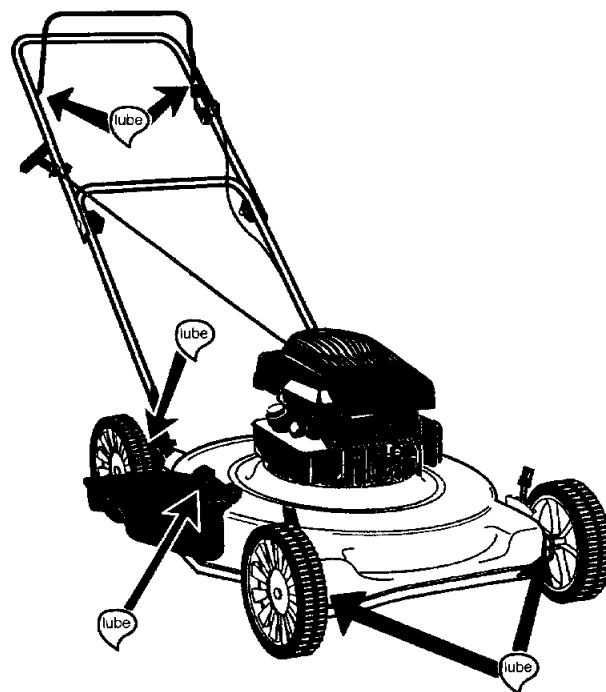

Figure 11: Lubrication Chart

MAINTENANCE



WARNING: Be sure to disconnect and ground the spark plug wire before performing any repairs or maintenance.

1. CUTTING BLADE



Warning: When removing the cutting blade for sharpening or replacement, protect hands by using heavy gloves or a rag to grasp the cutting blade.

NOTE: When tipping the unit, empty the fuel tank and keep engine spark plug side up.

- Remove the bolt and blade support or bell washer which hold the blade and adapter to the engine

crankshaft. Remove the blade and adapter from the crankshaft.

NOTE: If the blade is secured to the blade adapter with two bolts, remove the two small bolts, lock washers and nuts which hold the blade to the adapter.



WARNING: Periodically inspect the blade adapter for cracks, especially if you strike a foreign object. Replace when necessary.

a. Sharpening Blade:

- Follow the original angle of grind as a guide. Make sure that each cutting edge receives an equal amount of grinding to prevent an unbalanced blade.

NOTE: An unbalanced blade will cause excessive vibration when rotating at high speeds, may cause damage to the mower and could break, causing personal injury.

- Test the blade by balancing it on a round shaft screwdriver.
- Remove metal from the heavy side until it balances evenly. It is recommended that the blade always be removed from the adapter for the best test of balance.
- Before reassembling the blade and the blade adapter to the unit, lubricate the engine crankshaft and the inner surface of the blade adapter with light oil (or engine oil). Lubricating the bolt holes, bolts and inner surface of the nuts is also recommended.

b. Replacing Blade:

THREE BOLT BLADE MOUNTING:

- Install the blade to the blade adapter with the side of the blade marked "bottom" (or with part number)

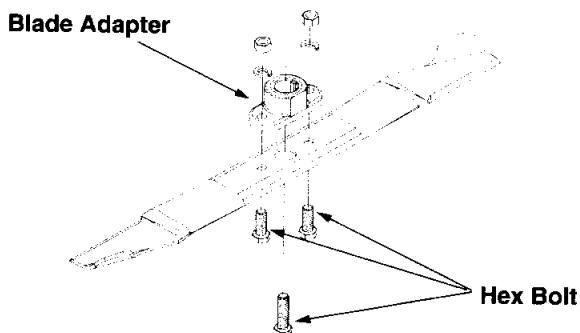

Figure 12

facing away from the adapter. See figure 12.

- Insert two hex bolts up through the blade and adapter and secure with lock washers and hex nuts.
- Tighten according to the blade mounting torque

mentioned below.

- Place the blade and the blade adapter assembly on the engine crankshaft.

NOTE: If the adapter is keyed, make sure that the key in the adapter is aligned with the key slot on the crankshaft.

- Place the bell washer on the hex nut with the crowned side of the bell washer against the head of the bolt. See figure 12.
- Insert the hex bolt and bell washer assembly through the blade and blade adapter assembly.
- Tighten the hex bolt according to the blade mounting torque mentioned below.

SINGLE BOLT BLADE MOUNTING

- Install the blade adapter on the crankshaft with the "star" away from the engine. See figure 13.
- Place the blade with the side marked bottom (or with part number) facing away from the adapter.
- Place the blade bell support over the blade aligning the tabs in the holes of the blade with the hole in the

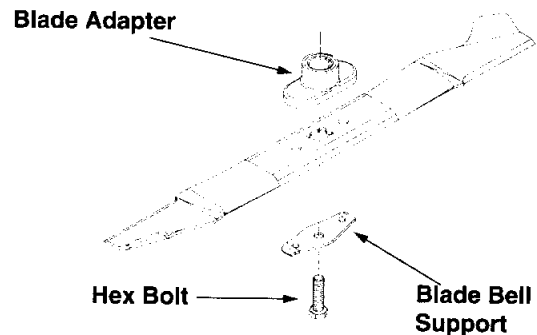

Figure 13

bell support and insert the hex bolt.

- Tighten the hex bolt according to the blade mounting torque mentioned below.

BLADE MOUNTING TORQUE

Center Bolt: 450 in. lbs. min., 600 in. lbs. max.;

Blade Adapter Bolts (if applicable): 200 in. lbs. min., 350 in. lbs. max.

To ensure safe operation of your unit, all nuts and bolts must be checked periodically for correct tightness.

2. DECK

The underside of the mower deck should be cleaned after each use to prevent a buildup of grass clippings, leaves, dirt or other matter. If this debris is allowed to accumulate, it will invite rust and corrosion, and may cause an uneven discharge of grass clippings at the next cutting.

The deck may be cleaned by tilting the mower and scraping clean with a suitable tool (make certain the spark plug wire is disconnected).

3. ENGINE

Refer to the separate engine manual for engine maintenance instructions.

- Maintain engine oil as instructed in the separate engine manual packed with your unit. Read and follow instructions carefully.
- Service air cleaner every 25 hours under normal conditions. Clean every few hours under extremely dusty conditions. Poor engine performance and flooding usually indicates that the air cleaner should be serviced. To service the air cleaner, refer to the separate engine manual packed with your unit.
- Clean the spark plug and reset the gap once a season. Spark plug replacement is recommended at the start of each mowing season. Check engine manual for correct plug type and gap specifications.
- Clean the engine regularly with a cloth or brush. Keep the cooling system (blower housing area) clean to permit proper air circulation which is essential to engine performance and life. Be certain to remove all grass, dirt and combustible debris from muffler area.

OFF-SEASON STORAGE

The following steps should be taken to prepare lawn mower for storage.

- Clean and lubricate mower thoroughly as described in the lubrication instructions.
- Refer to engine manual for correct engine storage instructions.
- Coat mower's cutting blade with chassis grease to prevent rusting.
- Store mower in a dry, clean area. Do not store next to corrosive materials, such as fertilizer.

NOTE: *When storing any type of power equipment in an unventilated or metal storage shed, care should be taken to rust-proof the equipment. Using a light oil or silicone, coat the equipment, especially cables and all moving parts.*

NOTE: The use of any accessory on this Rotary Mower other than those manufactured by the mower manufacturer is not recommended. GRASS CATCHER Model 190-110 is available as optional equipment for the mowers shown in this manual.



WARNING: To reduce the risk of injury, do not operate mower unless rear trailing shield and guard or entire grass catcher is in its proper place.

NOTE: Under normal usage bag material is subject to wear and should be checked periodically. Be sure to use only factory authorized replacement bag.

TROUBLE SHOOTING GUIDE

Trouble	Possible Cause	Corrective Action
Engine fails to start	<ol style="list-style-type: none"> 1. Blade control handle disengaged. 2. Spark plug wire disconnected. 3. Throttle control lever not in correct starting position. 4. Fuel tank empty, or stale fuel. 5. Blocked fuel line (if so equipped). 6. Faulty spark plug. 7. Engine flooded. 	<ol style="list-style-type: none"> 1. Engage blade control handle. 2. Connect wire to spark plug. 3. Move throttle lever to correct starting position. 4. Fill tank with clean, fresh gasoline. 5. Clean fuel line. 6. Clean, adjust gap or replace. 7. Crank engine with throttle in FAST position.
Engine runs erratic	<ol style="list-style-type: none"> 1. Unit running in CHOKE or START position. 2. Spark plug wire loose. 3. Blocked fuel line (if so equipped) or stale fuel. 4. Vent in gas cap plugged. 5. Water or dirt in fuel system. 6. Dirty air cleaner. 7. Carburetor out of adjustment. 	<ol style="list-style-type: none"> 1. Move throttle lever to FAST position. 2. Connect and tighten spark plug wire. 3. Clean fuel line; fill tank with clean, fresh gasoline. 4. Clear vent. 5. Drain fuel tank. Refill with fresh fuel. 6. Clean air cleaner. 7. Adjust carburetor.
Engine overheats	<ol style="list-style-type: none"> 1. Engine oil level low. 2. Air flow restricted. 3. Carburetor not adjusted properly. 	<ol style="list-style-type: none"> 1. Fill crankcase with proper oil. 2. Remove blower housing and clean. 3. Adjust carburetor.
Occasional skip (hesitates) at high speed	<ol style="list-style-type: none"> 1. Spark plug gap too close. 2. Carburetor idle mixture adjustment improperly set. 	<ol style="list-style-type: none"> 1. Adjust gap to .030" 2. Adjust carburetor.
Idles poorly	<ol style="list-style-type: none"> 1. Spark plug fouled, faulty or gap too wide. 2. Carburetor improperly adjusted. 3. Dirty air cleaner. 	<ol style="list-style-type: none"> 1. Reset gap to .030" or replace spark plug. 2. Adjust carburetor. 3. Clean air cleaner.
Excessive vibration	<ol style="list-style-type: none"> 1. Cutting blade loose or unbalanced. 2. Bent cutting blade. 	<ol style="list-style-type: none"> 1. Tighten blade and adapter. Balance blade. 2. Replace blade.
Mower will not discharge grass	<ol style="list-style-type: none"> 1. Engine speed too low. 2. Wet grass. 3. Excessively high grass. 	<ol style="list-style-type: none"> 1. Set throttle between 3/4 and full throttle. 2. Do not mow when grass is wet; wait until later to cut. 3. Mow once at a high cutting height, then mow again at desired height or make a narrower cutting swath (1/2 width).
Uneven cut	<ol style="list-style-type: none"> 1. Wheels not positioned correctly. 2. Dull blade. 	<ol style="list-style-type: none"> 1. Place all four wheels in same height position. 2. Sharpen or replace blade.

SLOPE GAUGE

USE THIS PAGE AS A GUIDE TO DETERMINE SLOPES WHERE YOU MAY NOT OPERATE SAFELY.

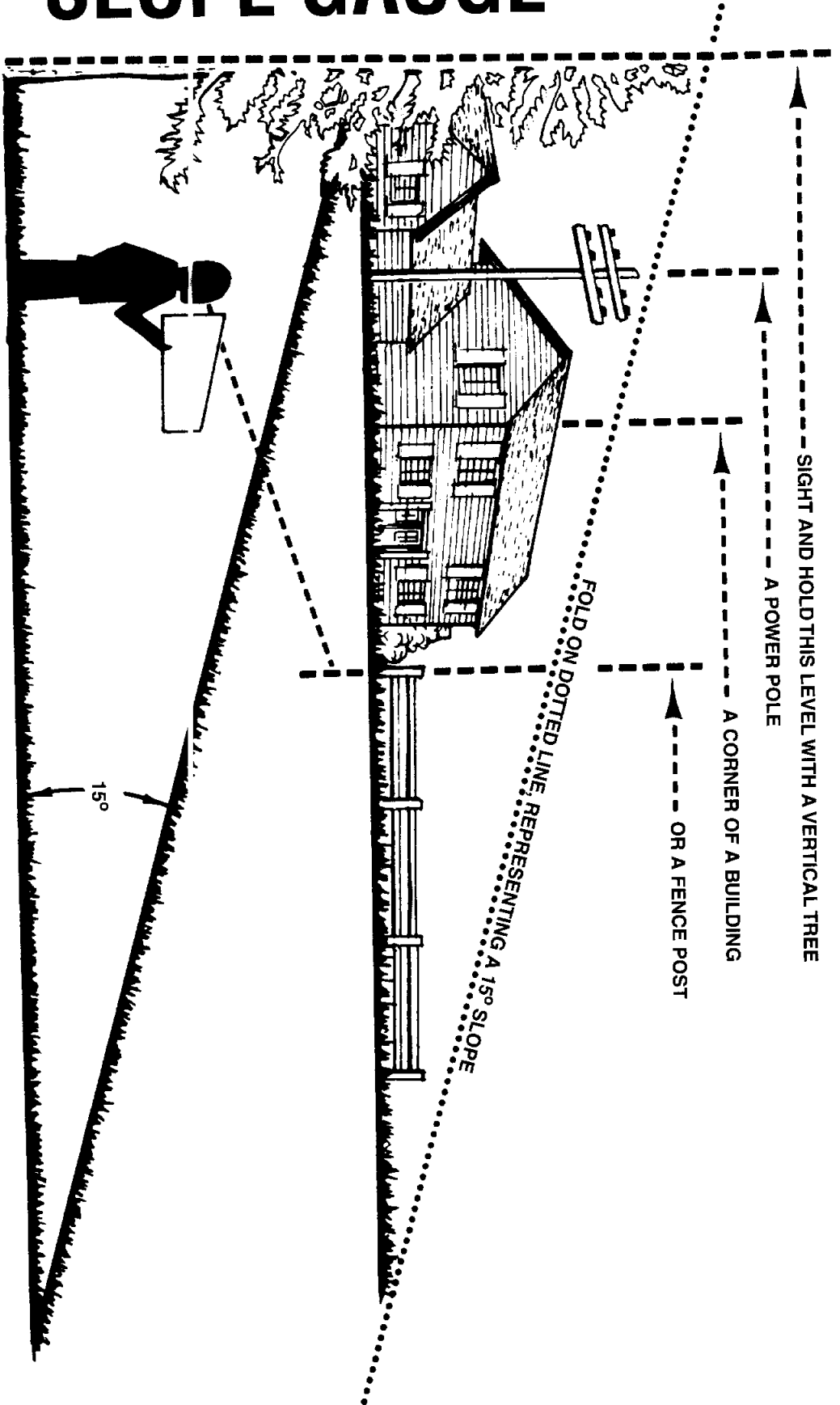

Do not mow on inclines with a slope in excess of 15 degrees (a rise of approximately 2-1/2 feet every 10 feet). A riding mower could overturn and cause serious injury. If operating a walk-behind mower on such a slope, it is extremely difficult to maintain your footing and you could slip, resulting in serious injury.

Operate RIDING mowers up and down slopes, never across the face of slopes.
Operate WALK-BEHIND mowers across the face of slopes, never up and down slopes.

Copy the information from your model plate here!

□	□	□	□	□	□	□	□	□	□	□	□
Model Number											
□	□	□	□	□	□	□	□	□	□	□	□
Serial Number											
□	□	□	□	□	□	□	□	□	□	□	□

**Please help us
help you!**

Call Now!

1(800) 800-7310

For Parts, Accessories or Service Information
Please have your model number ready when you call

The only way to ensure the performance of your product is to use original equipment parts and accessories. MTD designs and engineers quality parts to exacting specifications. When you substitute, you take a chance on quality, reliability , safety and performance. Use MTD original equipment parts for all of your parts and accessories needs.