

OWNER'S/ OPERATOR'S MANUAL

MODEL NO.'s
PLR-48 PLR-72
PLR-60 PBX-42

⚠ CAUTION

For Safe Operation
Read Rules And
Instructions Carefully

**SINO LEEINGLES, PIDA AYUDA
A AIGUIEN QUE SI LO LEA
PARA QUE LE TRADUZCA LAS
MEDIDAS DE SEGURIDAD.**



4 ft. Landscape Rake Shown



42" Box Scraper Shown

STATEMENT OF POLICY

It is the policy of Worksaver, Inc. to improve its products where it is possible and practical to do so. Worksaver, Inc. reserves the right to make changes or improvements in design and construction at any time, without incurring the obligation to make these changes on previously manufactured units.

ATV or Garden Tractor LANDSCAPE RAKE BOX SCRAPER

Safety Instructions
Tractor Preparation
Operating Instructions

Assembly & Mounting
Maintenance
Repair Parts

⚠ CAUTION

THE FOLLOWING SAFETY PRECAUTIONS SHOULD BE THOROUGHLY UNDERSTOOD BEFORE ATTEMPTING TO BEGIN ASSEMBLING THIS MACHINE

1. Select an area for assembly that is clean and free of any debris which might cause persons working on the assembly to trip.
2. Do not lift heavy parts or assemblies. Use crane, jack, tackle, fork trucks or other mechanical devices.
3. Preview the assembly instructions in your operator's manual before proceeding further.
4. If the assembly instructions call for parts or assemblies to be blocked up, use only blocking material that is in good condition and is capable of handling the weight of the assembly to be blocked. Also insure that the blocking material is on a clean, dry surface.
5. Never put hands, or any part of body, under blocked up assemblies if at all possible.
6. After completing assembly, thoroughly inspect the machine to be sure that all nuts, bolts, hydraulic fittings or any other fastened assemblies have been thoroughly tightened.
7. Before operating the machine, thoroughly read the operation section of your operator's manual.
8. Before operating, read the maintenance section of your operator's manual to be sure that any parts requiring lubrication, such as gearboxes, are full, to avoid any possible damage.
9. **Before operating equipment – If you have any questions regarding the proper assembly or operation, contact your dealer or representative.**

To the Owner/Operator/Dealer

All implements with moving parts are potentially hazardous. There is no substitute for a cautious, safe-minded operator who recognizes the potential hazards and follows reasonable safety practices. The manufacturer has designed this implement to be used with all its safety equipment properly attached to minimize the chance of accidents.

BEFORE YOU START!!

**Read the safety messages on the implement and shown in your manual.
Observe the rules of safety and common sense!**



THIS SYMBOL MEANS

- ATTENTION!**
- BECOME ALERT!**
- YOUR SAFETY IS INVOLVED!**

THIS SAFETY ALERT SYMBOL IDENTIFIES IMPORTANT SAFETY WARNING MESSAGES. CAREFULLY READ EACH WARNING MESSAGE THAT FOLLOWS. FAILURE TO UNDERSTAND AND OBEY A SAFETY WARNING, OR RECOGNIZE A SAFETY HAZARD, COULD RESULT IN AN INJURY OR DEATH TO YOU OR OTHERS AROUND YOU. THE OPERATOR IS ULTIMATELY RESPONSIBLE FOR THE SAFETY OF HIMSELF, AS WELL AS OTHERS, IN THE OPERATING AREA OF THE TRACTOR AND EQUIPMENT.

UNDERSTAND SIGNAL WORDS

Note the use of the signal words **DANGER**, **WARNING** and **CAUTION** with the safety messages. The appropriate signal word for each has been selected using the following guidelines:

DANGER: Indicates an imminently hazardous situation that, if not avoided, will result in death or serious injury. This signal word is to be limited to the most extreme situations typically for machine components which, for functional purposes, cannot be guarded.

WARNING: Indicates a potentially hazardous situation that, if not avoided, could result in death or serious injury, and includes hazards that are exposed when guards are removed. It may also be used to alert against unsafe practices.

CAUTION: Indicates a potentially hazardous situation that, if not avoided, may result in minor or moderate injury. It may also be used to alert against unsafe practices.

IMPORTANT SAFETY INFORMATION!

Working with unfamiliar equipment can lead to careless injuries. Read this manual, and the manual for your tractor, before assembly or operating, to acquaint yourself with the machine. It is the equipment owner's responsibility, if this equipment is used by any person other than yourself, is loaned or rented, to make certain that the operator, prior to operating:

1. Reads and understands the operator's manuals.
2. Is instructed in safe and proper use.

















The use of this equipment is subject to certain hazards which cannot be protected against by mechanical means or product design. All operators of this equipment must read and understand this entire manual, paying particular attention to safety and operating instructions, prior to using. If there is something in this manual you do not understand, ask your supervisor, or your dealer, to explain it to you.



Most accidents occur because of neglect or carelessness. Keep all helpers and bystanders twenty-five feet (25') from operating equipment. Only properly trained people should operate this tractor and attached implement. It is recommended the tractor be equipped with a Roll-Over Protection System (ROPS) and a seat belt that is used. Always stop the tractor, set brake, shut off the tractor engine, remove the tractor key, and lower implement to the ground before dismounting tractor. Never leave equipment unattended with the tractor running.

SAFETY INFORMATION (continued)

-  All equipment is potentially hazardous. There is no substitute for a cautious, safe-minded operator who recognizes potential hazards and follows reasonable safety practices.
-  When the use of hand tools is required to perform any part of assembly, installation, adjustment, maintaining, repairing, removal, or moving the implement, be sure the tools used are designed and recommended by the tool manufacturer for that specific task.
-  Personal protection equipment including safety glasses, safety shoes, and gloves are recommended during assembly, installation, operation, adjustment, maintaining, repairing, removal, or moving of the implement.
-  Always use two people to handle heavy, unwieldy components during assembly, installation, removal, or moving of the implement.
-  Never place any part of your body where it would be in danger if movement should occur during assembly, installation, operation, maintaining, repairing, removal, or moving the implement.
-  Never place yourself between the tractor and implement while implement is in operation.
-  Do not work under a raised implement unless it is securely blocked or held in position.
-  A heavy load can cause instability of the tractor. Use extreme care during travel. Slow down on turns and watch out for bumps. The tractor may need front counter-weights to counter-balance the weight of the implement. An unstable tractor could steer badly and possibly tip over, causing injury or death.
-  Never use alcoholic beverages or drugs which can hinder alertness or coordination while operating equipment. Consult your doctor about operating tractor and implement while taking prescription medications.
-  Do not allow others to ride on the tractor with an operator. Riders are subject to injury such as being struck by foreign objects or being thrown off. Riders obstruct the operator's view resulting in unsafe operation. **Never allow anyone to ride on the implement!**
-  Before you operate any implement, check over all pins, bolts and connections to be sure all are securely in place. Replace any damaged or worn parts immediately.
-  Do not allow anyone who is not familiar with the safety rules and operation instructions to use this equipment.
-  Never allow children to operate or be around equipment.
-  Do not exceed capacity of the tractor or ATV.
-  Keep alert and watch the front as well as the rear when working with implements.

SAFETY INFORMATION (continued)



When maneuvering close to buildings or passing through narrow areas, be sure to allow sufficient clearance for the implement and tractor.



Do not operate close to ditches or creeks. Slow down when operating over rough ground.



Always be sure the implement is in the fully raised position when in transport.



Pull from drawbar only. Failure to hitch properly could cause tractor to flip over, resulting in serious injury or death.



Reduce speed on slopes and sharp turns to minimize tipping or loss of control. Be careful when changing directions on slopes. Do not start or stop suddenly on slopes. Avoid operation on steep slopes.



Never exceed the limits of a piece of machinery. If its ability to do a job, or to do so safely, is in question - **DON'T TRY IT.**



Avoid excessive speed during operation.



Make adjustments only when the implement is attached to the tractor.



Always ease the tractor into the load. It may be necessary to reposition and take less "bite" on the material to move it safely.



Watch for and avoid hidden obstructions, i.e., buried pipes, rocks, concrete piers, uneven concrete slabs, stumps, etc., when operating landscape rakes, box scrapers, or other ground engaging implements.



Never operate tractor and implement under trees with low hanging limbs. Operators can be knocked off the tractor and then run over by the implement.



Stay alert for holes, rocks and roots in the terrain and other hidden hazards. Keep away from drop-offs.



Use extreme care and maintain minimum ground speed when transporting on hillside, over rough ground and when operating close to ditches or fences. Be careful when turning sharp corners.



Pass diagonally through sharp dips and avoid sharp drops to prevent "hanging up" tractor and implement. Practice will improve your skills in maneuvering rough terrain.



Always angle down slopes; never across the face. Avoid operation on steep slopes. Slow down on sharp turns and slopes to prevent tipping and/or loss of control.



Always shut off tractor and shift to "Park" or set brakes when leaving tractor. Always lower implement to ground. Remove key when leaving tractor unattended.



Before operating equipment: if you have any questions regarding the proper assembly or operation, contact your dealer or representative.

INSTRUCTIONS

TRACTOR REQUIREMENTS AND PREPARATION

The PLR Series landscape rakes and PBX-42 box scraper are designed for small lawn/garden tractors and ATV units equipped with a rear pull type hitch.

For the different width landscape rake units, we recommend the following minimum size lawn/garden tractor:

<u>Rake</u>	<u>Min. Tractor H.P.</u>
PLR-48	10-12 H.P.
PLR-60	12-15 H.P.
PLR-72	15-18 H.P.

For the PBX-42 box scrapers, we recommend a 12-15 hp tractor.

ATV units need to have a low gear and be of sufficient size (see the chart above for tractors and use a conversion of 12 cc engine size equals 1 hp).

Small tractors may need wheel weights to have enough traction.



CAUTION!

Be sure tractor or ATV is in good condition. Read all the safety precautions and make sure all operators are familiar with the safety rules of operation.

PACKING

The landscape rake is usually shipped as two bundles:

1. Main Frame
2. Rake Tine Bar Assembly (teeth installed).

The box scraper is shipped as welded assembly.

ASSEMBLY

For instruction reference, the terms front or rear are based on the operator facing forward on the tractor, thus front is toward the front of the tractor and the rear is to the rear of the tractor.

It is suggested that all the instructions be read before beginning assembly.

Check the exploded view of the landscape rake or box scraper in this manual to get an idea of the relationship between the parts.

The two main subassemblies of the landscape rake are heavy and awkward to handle. It is recommended that you have one or two helpers to complete the assembly.

It is suggested that you hook the clevis hitch of the main frame to your tractor before assembling. If this is not possible, block the hitch off the ground 5-6 inches.

Slide the landscape rake tinebar assembly under the main frame. Raise the front of the tinebar and block below the angle tinebar. Insert the 1" x 4" hex head bolt into the bottom of the center angle adjustment plate on the tinebar and then through the 1" diameter hole in the main frame. (Threaded end up). Place a 1" flat washer on the bolt and then install the 1" nylock hex nut. Tighten this nut until it is just lightly snug – you want to be able to angle the tinebar but have a minimum amount of looseness.

To assemble the box scraper weldment, slide the box scraper under the main frame and install the 1" hex head bolt as described above for the landscape rake tinebar. Then install the two 1/2" hex head bolts into the rear of the main frame circle plate and the mounting bracket on the box scraper. Tighten all bolts on the box scraper attachment.

On the landscape rake, set the desired angle of the tinebar assembly and install the angle shift pin.

The operating height of the landscape rake and the box scraper is set by the turnbuckle adjustment. If the unit is on a flat level surface (concrete slab) you can set the depth of operation by raising the wheels off the surface. It is recommended that changes in operating depth be kept small. After operating the attachment a few times, you will get to know how much change your power unit can handle.

Tie one end of the pull rope to the upper end of the lift handle. The other end of the rope should be lightly tied to your tractor or ATV.



**SAFETY . . .
YOU CAN LIVE WITH IT!**

INSTRUCTIONS (continued)

SAFETY TRAINING

- Know your controls and how to stop tractor and engine quickly in an emergency. **READ THIS MANUAL AND THE ONE PROVIDED WITH YOUR TRACTOR OR ATV.**
- To avoid accident or injury, do not allow anyone to operate this equipment without proper instructions. Any person who operates this equipment must be instructed in and be capable of the safe operation of the tractor, implement and all controls.
- Do not allow children to operate this machine.
- Always wear relatively tight and belted clothing to avoid entanglement in moving parts. Wear sturdy, rough-soled work shoes and protective equipment for eyes, hands, and hearing. Never operate tractor in bare feet, sandals, or sneakers.
- Operate only in daylight or good artificial light.
- Ensure implement is properly mounted, adjusted and in good operating condition.
- Ensure that all safety shielding and safety signs are properly installed and in good condition.



- ▲ **Be sure tractor engine is off and key is removed before making any adjustments.**
- ▲ **Do not get under machine to make measurements or adjustments without securely blocking implement first.**

OPERATION

While standing by the landscape rake or box scraper, pull forward on the handle and remove the transport lock pin, then slowly release your pressure on the handle and let the handle swing to the rear. Make sure your feet are clear as the tinebar or box scraper lowers to the ground.

There is an extra set of holes at the top of the lever quadrant to store the transport lock pin while the implement is in use.

To place the implement into the transport position, just reverse the above procedure.

As you operate the landscape rake or box scraper, you need to pull on the rope and pull the handle forward to dump the material or to make a sharp turn. Releasing the rope allows the implement to return to its depth setting as controlled by the turnbuckle.

GRADING

Adjust the turnbuckle for the amount of cut you want to take. Set the rake angle adjustment as desired – straight for grading or angles for a windrowing effect.

It is recommended to operate the rake at a slow speed (max. 3 mph) to give ample time for fine material to flow through the tines.

When angle grading with the rake, the tinebar should be angled only enough to allow material to slide across easily.

LEVELING

The rake tinebar should be straight across (ie: 90° to the line of travel). The gauge wheels will make the leveling operation much easier. It will usually take several passes over the same area to obtain the desired result.

RAKING

Light vegetative trash, dirt clods, or rocks may be raked into piles or into windows for easier pick up. **DO NOT** overload rake tines – remove large rocks, roots or limbs before using the implement.

If you have a gravel or loose stone driveway, setting the rake at an angle and making several passes in the grass along each side of the drive will rake the stones out of the grass and back into the driveway.



Watch for and avoid catching the rake on stumps, large rocks, or other immovable objects.

INCORPORATING SEED: Seed is best incorporated by making two passes in diagonal directions. Consult your seed supplier or reference book for the recommended seed depth. Set the rake straight and operate the rake at two times the recommended seed depth. Grass seed, for example, should be covered approximately 1/4". Operate the rake at 1/2" penetration and make two passes in diagonal directions.

INSTRUCTIONS (continued)

MAINTENANCE

Straighten or replace any tines which may have bent due to hitting buried or solid objects.

Check the angle shift pin for excessive wear and replace if necessary.

Repaint parts where paint is worn or scratched to prevent rust.

Check all bolts and nuts to be sure they are tight except nylock nut pivot bolts – these should be just snug.

Periodically oil the following:

- Turnbuckle threads
- Pivot points

STORING SAFELY

At the end of the working season or when the implement will not be used for a long period, it is good practice to clean off any dirt that may have accumulated.

Inspect the implement for loose, damaged or worn parts and adjust or replace if needed.

Repaint parts where paint is worn or scratched to prevent rust.

Store in a clean, dry place away from where children play.

-
-
- U Keep children away from danger all day, every day.
 - U Equip tractors with rollover protection (ROPS) and keep all machinery guards in place.
 - U Please work, drive, play, and live each day with care and concern for your safety and that of your family and fellow citizens.

**O B E Y A L L
S A F E T Y W A R N I N G S ! !**

PLR LANDSCAPE RAKE
AND
PBX-42 BOX SCRAPER
PARTS LIST

PLR CHASSIS ASSEMBLY			
NO.	PART NO.	DESCRIPTION	QTY.
1	341921	BEAM HITCH WELDMENT	1
2	341930	WHEEL PIVOT WELDMENT	1
3	341926	ADJUSTMENT PLATE	1
4	341927	UPPER LEVELING ARM BRACKET	1
5	341928	LOWER LEVELING ARM BRACKET	1
6	341929	LEVELING ARM	1
7	341935	WHEEL ASSEMBLY	2
8	590125	TOP LINK, AK-300, CATEGORY 0	1
9	2503024	BOLT, 3/4"-10NC x 3-1/2", HEX HEAD	1
10	2500075	NUT, 3/4"-10NC, NYLOCK HEX JAM	3
11	2503033	BOLT, 3/4"-10NC x 5", HEX HEAD	2
12	2501002	WASHER, 3/4", MEDIUM FLAT	2
13	2500002	NUT, 3/4"-10NC, HEX	2
14	2503012	BOLT, 1/2"-13NC x 3" GR. 2, HEX HEAD	2
15	2503004	BOLT, 1/2"-13NC x 1-1/2", HEX HEAD	4
16	2502002	WASHER, 1/2", SPRING LOCK	6
17	2500003	NUT, 1/2"-13NC, HEX	10
18	2503048	BOLT, 5/8"-11NC x 2", HEX HEAD	3
19	2502007	WASHER, 5/8", SPRING LOCK	3
20	2500013	NUT, 5/8"-11NC, HEX	3
21	341857	SHIFT PIN, 1/2" x 3-1/4"	2
22	341936	ROPE, 5/16", BRAIDED SISAL	1
23	2503226	BOLT, 1"-8NC x 4", HEX HEAD	1
24	2501001	WASHER, 1", MEDIUM FLAT	2
25	2500085	NUT, 1"-8NC, NYLOCK HEX JAM	1

RAKE ASSEMBLIES			
NO.	PART NO.	DESCRIPTION	QTY.
26	341701	TINEBAR WELDMENT PLR-48	1
	341711	TINEBAR WELDMENT PLR-60	1
	341721	TINEBAR WELDMENT PLR-72	1
27	341704	RAKE TOOTH PLR-48	24
		RAKE TOOTH PLR-60	30
		RAKE TOOTH PLR-72	36
28	341705	TOOTH SUPPORT PLR-48	4
		TOOTH SUPPORT PLR-60	5
		TOOTH SUPPORT PLR-72	6
29	2503103	BOLT 3/8"-16NC x 1 1/2" CARRIAGE HEAD (PLR-48)	24
		BOLT 3/8"-16NC x 1 1/2" CARRIAGE HEAD (PLR-60)	30
		BOLT 3/8"-16NC x 1 1/2" CARRIAGE HEAD (PLR-72)	36
30	2500081	NUT 3/8"-16NC WHIZ FLANGE HEX (PLR-48)	24
		NUT 3/8"-16NC WHIZ FLANGE HEX (PLR-60)	30
		NUT 3/8"-16NC WHIZ FLANGE HEX (PLR-72)	36

BOX SCRAPER ASSEMBLY			
NO.	PART NO.	DESCRIPTION	QTY.
32	341956	BOX SCRAPER WELDMENT 42"	1
33	2503026	BOLT, 1/2"-13NC x 1 1/4" GR. 2, HEX HEAD	2
34	2502002	WASHER, 1/2", SPRING LOCK	2
35	2500003	NUT, 1/2"-13NC, HEX	2

PLR LANDSCAPE RAKE
 AND
 PBX-42 BOX SCRAPER
 PARTS DRAWING

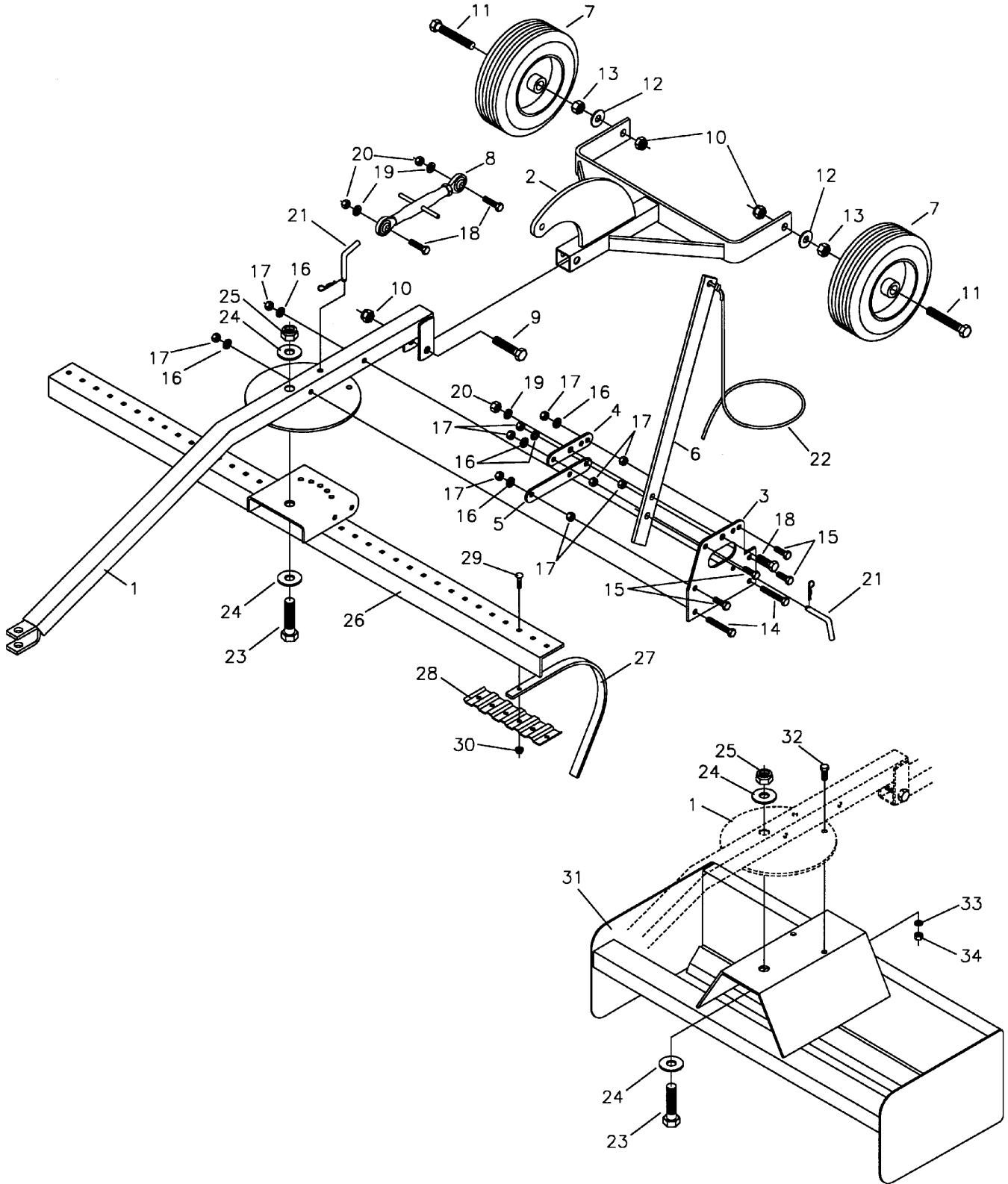

⚠ SAFETY PRECAUTIONS ⚠

**MOST ACCIDENTS OCCUR BECAUSE OF NEGLIGENCE OR CARELESSNESS.
AVOID NEEDLESS ACCIDENTS BY FOLLOWING ALL OF THE SAFETY PRECAUTIONS LISTED BELOW.**

- Machinery should be operated only by those who are responsible and are authorized to do so.
- Stop the engine, lower all equipment, lock the brakes, and remove the ignition key before dismounting from the tractor.
- Never stand between tractor and implement while tractor is being backed to hitch.
- Loose fitting clothing should not be worn, to avoid catching on various parts.
- Detach implement in area where children normally do not play.
- When performing adjustments or maintenance on an implement, first lower it to the ground or block it securely at a workable height.
- Only a qualified operator should be permitted on tractor when in operation; no riders allowed.
- Make certain everyone is in the clear before starting tractor or raising or lowering equipment.
- Operate the tractor and implement only while seated in the driver's seat.
- Reduce speed when transporting mounted implements to avoid bouncing and momentary loss of steering control.
- A heavy load can cause instability of the tractor. Use extreme care during road travel. Slow down on turns and watch out for bumps. Tractor may need front counterweights to counter-balance the weight of the implement.
- Reduce speed on hillsides or curves so there is no danger of tipping.
- Avoid driving too close to the edge of ditches or creeks.
- Do not transport implement on public roads without reflectors and slow moving vehicle emblem in daylight and with approved warning lights at night and other periods of poor visibility.
- Due to the width of some implements, use extra caution on highways, farm roads, and when approaching gates.
- Always be sure the implement is in the proper position for transport.
- Keep alert and watch the front as well as the rear when working with the implement.

OWNER'S/ OPERATOR'S MANUAL

MODEL NO.'s
PLR-48
PLR-60
PLR-72
PBX-42

**WHEN ORDERING
REPAIR PARTS, ALWAYS
GIVE THE FOLLOWING
INFORMATION:**

1. PART NUMBER
2. PART DESCRIPTION
3. MODEL NUMBER
4. NAME OF ITEM

MARCH 2001

***Please work, drive, play and live each day with
care and concern for your safety and that of your
family and fellow citizens.***

**MAKE EVERY DAY
A HOLIDAY FROM ACCIDENTS**

**PULL TYPE LANDSCAPE RAKE
PULL TYPE BOX SCRAPER**

WORKSAVER LIMITED WARRANTY

W orksaver warrants its implements, parts and accessories to be free from defects in materials and workmanship for a period of six (6) months from date of purchase. Upon written approval, W orksaver will repair or exchange without charge any part, which upon examination by W orksaver or its authorized agent, shall disclose to be defective.

This does not apply to (1) parts that have worn out in normal use, (2) parts broken because of improper assembly or operation by the customer, (3) parts accidentally damaged, (4) failure of parts traceable to improper care, (5) parts failing through use of implement for purposes other than those for which it was designed.

The obligations assumed by W orksaver and the limitations expressed herein are in lieu of all other warranties expressed or implied.

W O R K S A V E R , I N C .

P.O. BOX 100 LITCHFIELD, IL 62056-0100 (217) 324-5973

WEB: <http://www.worksaver.com> E-MAIL: sales@worksaver.com