

Attachment Illustrated Parts List



Attachment

| Mfg. No. | Description |
|----------|-----------------------|
| 1694508 | 54" Grass Mulcher Kit |

Simplicity

MANUFACTURING, INC.
500 N. Spring Street / PO Box 997
Port Washington, WI 53074-0997 USA

www.simplicitymfg.com

© Copyright 2007 Simplicity Manufacturing, Inc. All Rights Reserved. Printed In USA.

Part No.: 1734845

Rev. 04/2007

TP 400-4561-00-AT-SMA

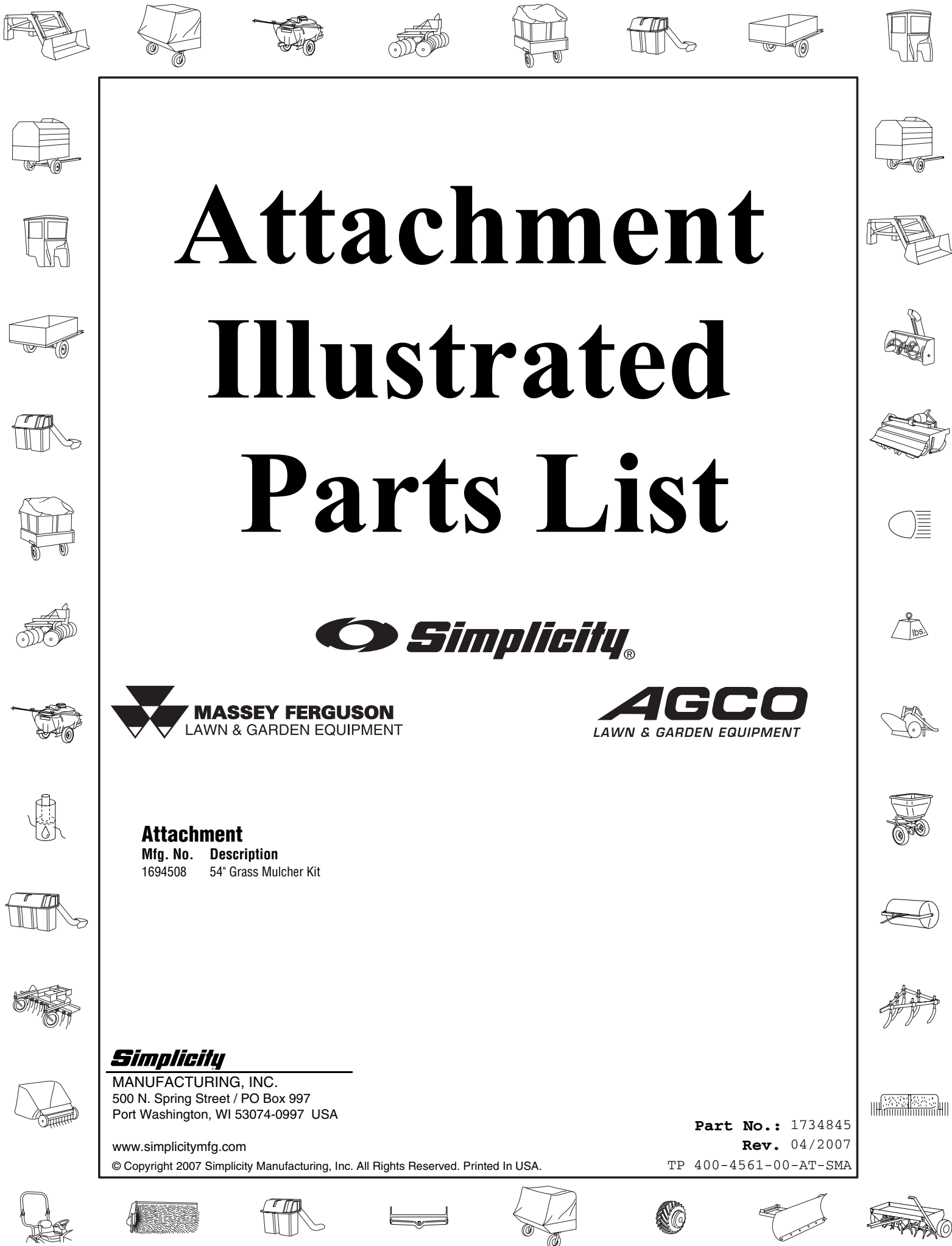

| PRODUCT COMPONENTS | PAGES |
|---|--------------------------|
| 54" Grass Mulcher Kit | 4 |
| Torque Specification Chart | Inside Back Cover |

54" Grass Mulcher Kit

986452

NOTE: Unless noted otherwise, use the standard hardware torque specification chart.

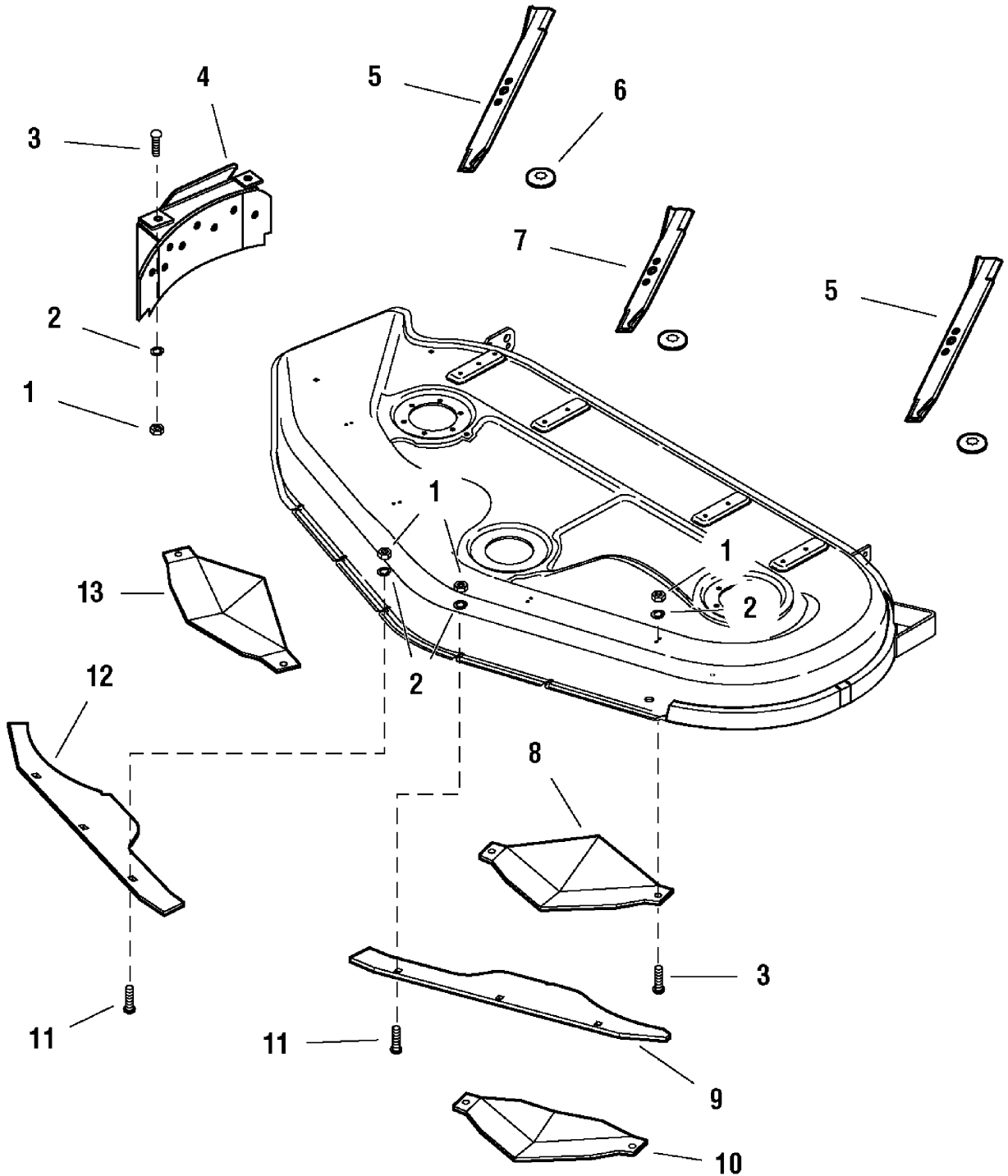

The above parts group applies to the following Mfg. Nos.:

1694508 - 54" Grass Mulcher Kit

54" Grass Mulcher Kit

| REF NO | PART NO. | QTY. | DESCRIPTION |
|--------|------------|------|--|
| 1 | 1917372SM | 12 | NUT, Hex, 5/16-18 |
| 2 | 1917356SM | 12 | LOCKWASHER, Spring 5/16 |
| 3 | 1921332SM | 6 | CAPSCREW-HEX HD 5/16-18X0.750 G5 BLK |
| 4 | 1725801SM | 1 | COVER & PLATE ASSEMBLY, Discharge 54" Mulch |
| 5 | 1726013ASM | 2 | BLADE, Mower Large |
| 6 | 1679711SM | 3 | WASHER, Splined |
| 7 | 1726014ASM | 1 | BLADE, Mower Small |
| 8 | 1725909SM | 1 | *RAMP ASSEMBLY, LH 54" Mulcher NOTE* For Models 2004 and Later |
| 9 | 1720613ASM | 1 | BAFFLE, Mulching LH 54" |
| 10 | 1721068SM | 1 | **RAMP ASSEMBLY, LH 54" Mulcher NOTE** For Models 2003 and Earlier |
| 11 | 1931333SM | 6 | CARRIAGE BOLT, 5/16-18 x 3/4 G5 |
| 12 | 1721023ASM | 1 | BAFFLE, Mulching RH 54" |
| 13 | 1721075SM | 1 | RAMP ASSEMBLY, RH 54" Mulcher |

Footnotes

The above parts group applies to the following Mfg. Nos.:

1694508 - 54" Grass Mulcher Kit

Hardware Identification & Torque Specifications

Common Hardware Types

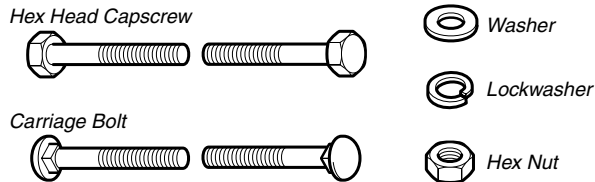

Standard Hardware Sizing

When a washer or nut is identified as **1/2"**, this is the *Nominal size*, meaning the *inside diameter* is 1/2 inch; if a second number is present it represent the *threads per inch*

When bolt or capscrew is identified as **1/2 - 16 x 2"**, this means the *Nominal size*, or *body diameter* is 1/2 inch; the second number represents the *threads per inch* (16 in this example, and the final number is the *body length* of the bolt or screw (in this example 2 inches long).

The guides and ruler furnished below are designed to help you select the appropriate hardware and tools.

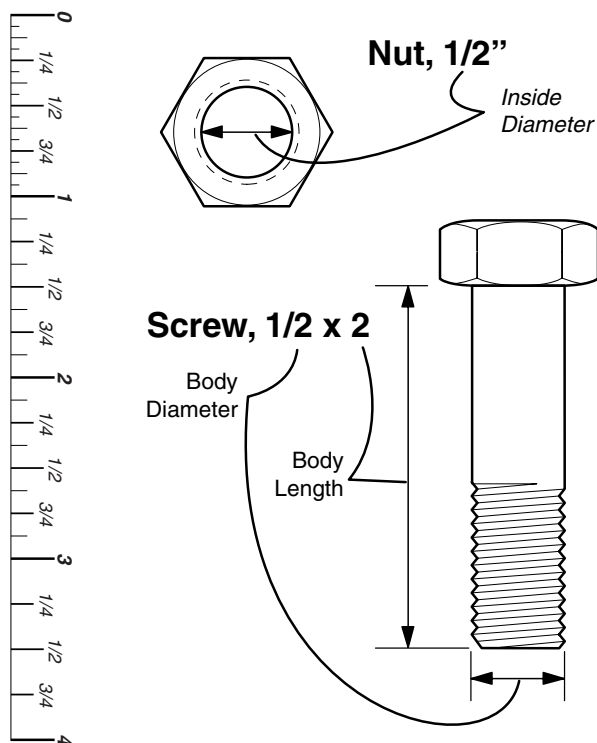

Torque Specification Chart

FOR STANDARD MACHINE HARDWARE (Tolerance $\pm 20\%$)

| Hardware Grade | No Marks | | No Marks | | No Marks | |
|------------------|------------------|-------|------------------|-------|------------------|---------|
| | SAE Grade 2 | | SAE Grade 5 | | SAE Grade 8 | |
| Size Of Hardware | in/lbs ft/lbs | Nm. | in/lbs ft/lbs | Nm. | in/lbs ft/lbs | Nm. |
| 8-32 | 19 | 2.1 | 30 | 3.4 | 41 | 4.6 |
| 8-36 | 20 | 2.3 | 31 | 3.5 | 43 | 4.9 |
| 10-24 | 27 | 3.1 | 43 | 4.9 | 60 | 6.8 |
| 10-32 | 31 | 3.5 | 49 | 5.5 | 68 | 7.7 |
| 1/4-20 | 66 | 7.6 | 8 | 10.9 | 12 | 16.3 |
| 1/4-28 | 76 | 8.6 | 10 | 13.6 | 14 | 19.0 |
| 5/16-18 | 11 | 15.0 | 17 | 23.1 | 25 | 34.0 |
| 5/16-24 | 12 | 16.3 | 19 | 25.8 | 27 | 34.0 |
| 3/8-16 | 20 | 27.2 | 30 | 40.8 | 45 | 61.2 |
| 3/8-24 | 23 | 31.3 | 35 | 47.6 | 50 | 68.0 |
| 7/16-14 | 30 | 40.8 | 50 | 68.0 | 70 | 95.2 |
| 7/16-20 | 35 | 47.6 | 55 | 74.8 | 80 | 108.8 |
| 1/2-13 | 50 | 68.0 | 75 | 102.0 | 110 | 149.6 |
| 1/2-20 | 55 | 74.8 | 90 | 122.4 | 120 | 163.2 |
| 9/16-12 | 65 | 88.4 | 110 | 149.6 | 150 | 204.0 |
| 9/16-18 | 75 | 102.0 | 120 | 163.2 | 170 | 231.2 |
| 5/8-11 | 90 | 122.4 | 150 | 204.0 | 220 | 299.2 |
| 5/8-18 | 100 | 136 | 180 | 244.8 | 240 | 326.4 |
| 3/4-10 | 160 | 217.6 | 260 | 353.6 | 386 | 525.0 |
| 3/4-16 | 180 | 244.8 | 300 | 408.0 | 420 | 571.2 |
| 7/8-9 | 140 | 190.4 | 400 | 544.0 | 600 | 816.0 |
| 7/8-14 | 155 | 210.8 | 440 | 598.4 | 660 | 897.6 |
| 1-8 | 220 | 299.2 | 580 | 788.8 | 900 | 1,244.0 |
| 1-12 | 240 | 326.4 | 640 | 870.4 | 1,000 | 1,360.0 |

NOTES

- These torque values are to be used for all hardware excluding: locknuts, self-tapping screws, thread forming screws, sheet metal screws and socket head setscrews.
- Recommended seating torque values for locknuts:
 - for prevailing torque locknuts - use 65% of grade 5 torques.
 - for flange whizlock nuts and screws - use 135% of grade 5 torques.
- Unless otherwise noted on assembly drawings, all torque values must meet this specification.

Wrench & Fastener Size Guide



1/4" Bolt or Nut
Wrench—7/16"

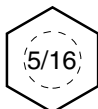

5/16" Bolt or Nut
Wrench—1/2"

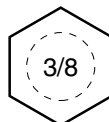

3/8" Bolt or Nut
Wrench—9/16"

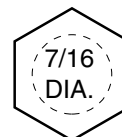

7/16" Bolt or Nut
Wrench (Bolt)—5/8"
Wrench (Nut)—11/16"

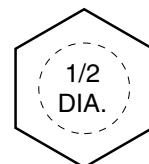

1/2" Bolt or Nut
Wrench—3/4"

