

SAMSUNG

OWNER'S INSTRUCTIONS

AWT18F1ME	AWT18F1MBB/BC
AWT20F1MB	AWT20F1MBA
AWT24F1MB	AWT24F1MBA/BC
AWT24F1ME	AWT18F1MEA/EB/EC
	AWT19F1MEA
	AWT24F1MEB/EC

WINDOW-TYPE ROOM AIR CONDITIONER (Cool)

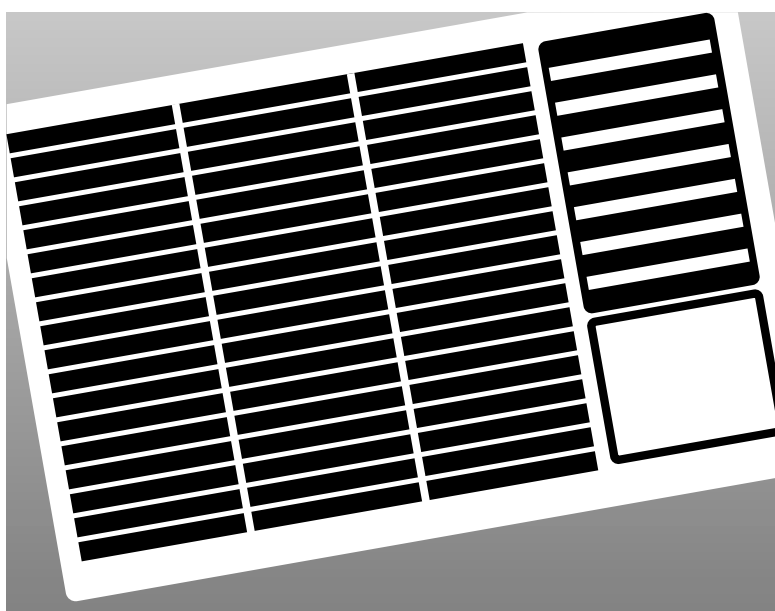

Safety Precautions

The following safety precautions must be taken when using your air conditioner.



WARNING

Risk of electric shock. • Can cause injury or death. • Disconnect all remote electric power supplies before servicing, installing or cleaning. • This must be done by the manufacturer or its service agent or a similar qualified person in order to avoid a hazard.

DURING OPERATION

- ◆ Users of this product are cautioned not to attempt repair of this product at their own discretion. Instead, they are requested to directly contact a designated service center or the outlet at which the product was purchased.
- ◆ Never spill any kind of liquid into the unit. Should this happen, unplug or main switch off the unit and contact an authorized service center.
- ◆ Do not insert anything between the air outlet blades because the inner fan may be damaged and could cause injury. Keep children away from the unit.
- ◆ Do not place any obstacles in front of the unit.
- ◆ Do not spray liquid of any kind into the indoor unit. Should this happen, switch off the breaker used for your air conditioner and contact your installation specialist.
- ◆ Make sure that the unit is correctly ventilated at all times:
Do not place clothing or other materials over it.
- ◆ If the wireless remote control will not be used for a long time, remove the batteries. (If applicable)
- ◆ When using a wireless remote control, the distance should not be more than 7 meters from the air conditioner. (If applicable)
- ◆ The air conditioner must be plugged into its own specific power source, which must be installed in compliance with national wiring, earthing and safety regulations.
- ◆ If the power cord is damaged in any way, it must be replaced by the manufacturer or its service agent or a similarly qualified person in order to avoid a hazard.
- ◆ This device must be installed according to the national electrical rules.
- ◆ The appliance must be installed that the plug should be easily accessible after installation.
- ◆ If the fuse on PC board is broken please change it with the type of T 3.15A 250V.
- ◆ The breaker of the air conditioner should be all-pole switch; and the distance between its two contacts should be no less than 3.5mm. Such means for disconnection must be incorporated in the fixed wiring.

DISPOSING OF THE UNIT

- ◆ Before throwing out the device, it is necessary to pull back the battery cells and get rid of them safely for recycling reasons.
- ◆ When you need to dispose of the unit, consult your dealer. If pipes are removed incorrectly, refrigerant may blow out and come into contact with your skin, causing injury. Releasing refrigerant into the atmosphere also damages the environments.
- ◆ Please recycle or dispose of the packaging material for this product in an environmentally responsible manner.

OTHERS

- ◆ Never store or ship the air conditioner upside down or sideways to avoid damage to the compressor.
- ◆ The appliance is not intended for use by young children or infirm persons without supervision: Young children should be supervised to ensure that they do not play with the appliance.
- ◆ Max current is measured according to IEC standard for safety and current is measured according to ISO standard for energy efficiency.

Contents

- ◆ PREPARING YOUR AIR CONDITIONER
 - Safety Precautions 2
 - Air Conditioning Unit - Main Parts and Control Panel 4
 - Getting Started 5
- ◆ OPERATING YOUR AIR CONDITIONER
 - Cooling Your Room 6
 - Airing Your Room 7
 - Switching the Air Conditioner Off 7
 - Adjusting the Air Flow Direction Horizontally 8
 - Adjusting the Air Flow Direction Vertically 8
- ◆ RECOMMENDATIONS FOR USE
 - Operating Recommendation 9
 - Temperature and Humidity Ranges 9
 - Cleaning Your Air Conditioner 10
 - Solving Common Problems 11
 - Technical Specifications 11
- ◆ METHOD OF INSTALLATION 12

Air Conditioning Unit - Main Parts and Control Panel

* The design and shape are subject to change, depending on the model.

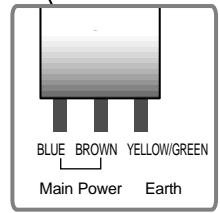
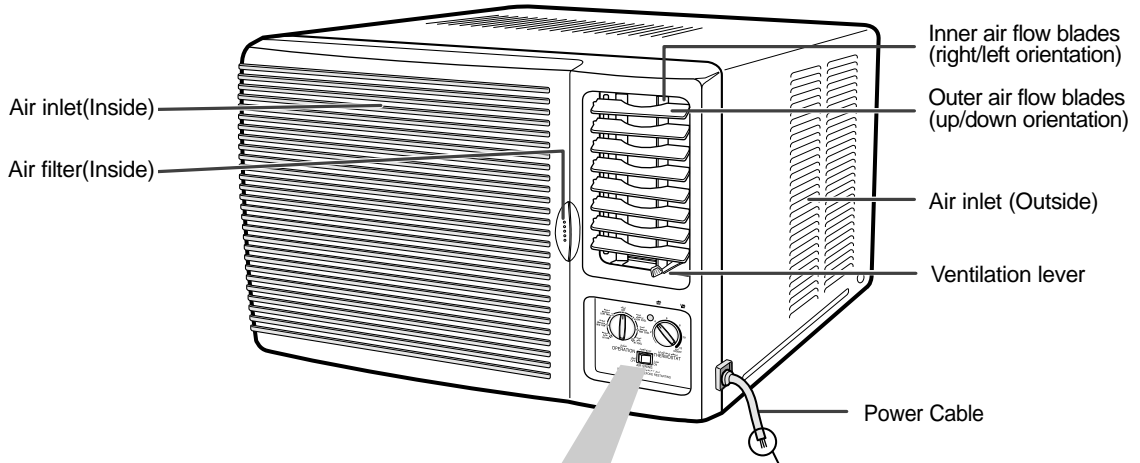

* Power cable connection should be committed to an installation engineer.

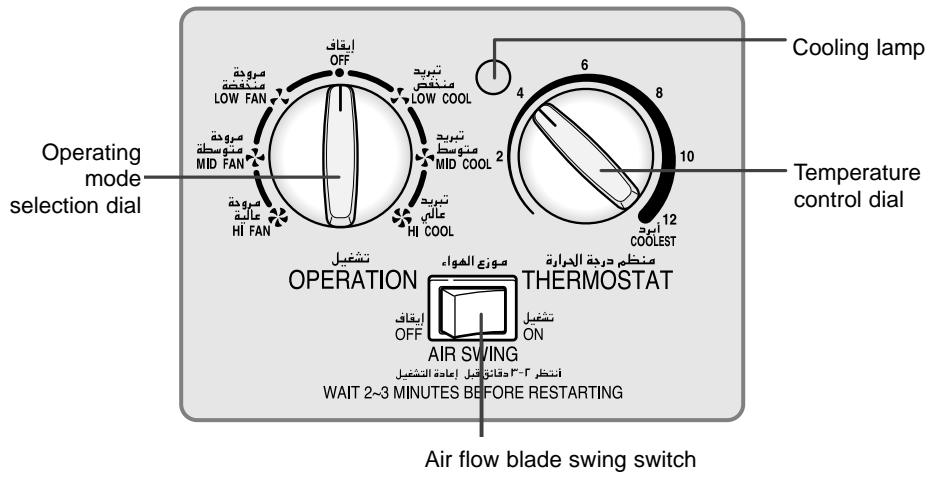

Getting Started

You have just purchased a window-type room air conditioner and it has been installed by your installation specialist.

Your Owner's Instructions contain much valuable information on using your air conditioner. Please take the time to read them as they will help you take full advantage of the unit's features.

The booklet is organized as follows.

- ◆ ***The illustration on page 4 shows the air conditioning unit; it indicates the location and purpose of the main parts and controls on the unit.***
- ◆ ***In the main part of the document, you will find a series of step-by-step procedures for each function available.***

The illustrations in the step-by-step procedures use four different symbols:

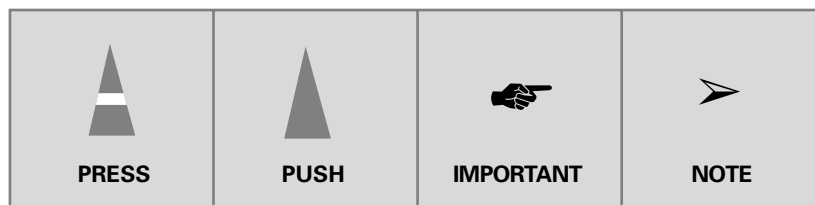

Cooling Your Room

You must select the Cool mode if you wish to lower the temperature in your room. You can also set the fan speed.

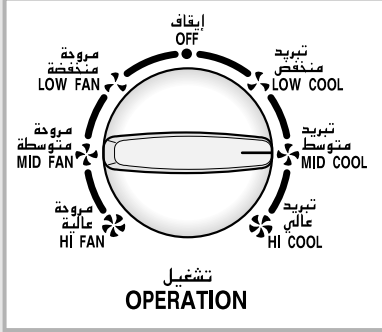

- 1 Select the operating mode and fan speed.

To cool your room with a...

Set the operating mode selection dial to...

High fan speed

HI COOL

Mid fan speed

MID COOL

Low fan speed

LOW COOL

- Result:**
- ◆ The air conditioner starts up in Cool mode.
 - ◆ The fan starts up at the speed selected.

➤ You can change modes at any time.

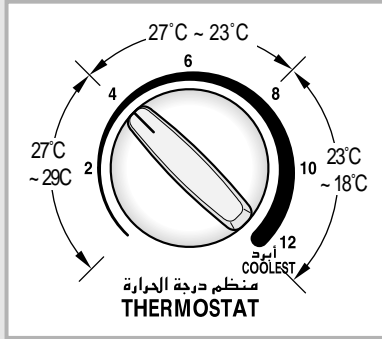

- 2 To adjust the temperature, turn the temperature control dial to the desired position.

Possible temperatures: Between 18°C and 29°C inclusive.

- Result:** The air conditioner is started cooling as turn on the cooling lamp, if room temperature is higher than selected temperature.

- 3 To control the direction of the air flow, refer to page 8.

Airing Your Room

If the atmosphere in your room is stale, you can air it using the Fan feature and if necessary, evacuate the stale air outside.

- 1 If you wish to evacuate stale air outside, push the ventilation lever on the front of the unit to the right and the open position ().

Result: The air inside the room circulates and stale air is evacuated outside.

Otherwise, push the ventilation lever to the left and the closed position ().

Result: The air simply circulates inside the room.

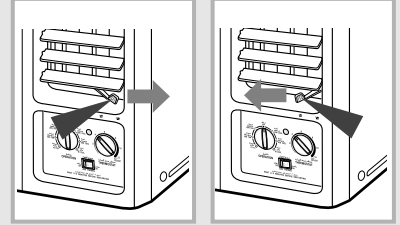

- 2 Set the operating mode selection dial to the HI FAN, MID FAN or LOW FAN position.

- HI FAN : The fan turns high speed.
- MID FAN : The fan turns mid speed.
- LOW FAN : The fan turns low speed.

Result: The air conditioner starts up in Fan mode.

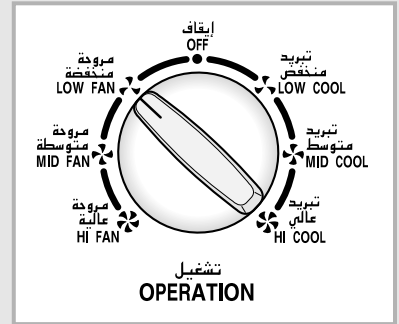

- 3 To control the direction of the air flow, refer to page 8.

Switching the Air Conditioner Off

You can switch the air conditioner off whenever you want.

- 1 To switch the unit off, simply set the operating mode selection dial to the OFF position.

Result: The air conditioner stops operating.

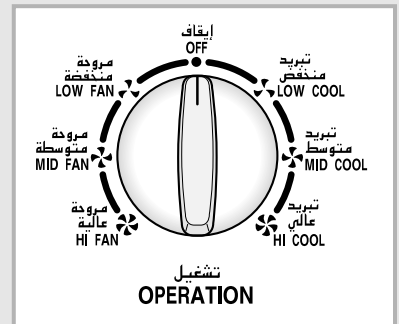

Adjusting the Air Flow Direction Horizontally

Depending on the position of the unit in your room, you can adjust the orientation of the inner air flow blades on the right-hand side of the unit, thus increasing the efficiency of the air conditioner.



- 1 Set the air flow blade swing switch to the **ON** position.

Result: The inner blades swing automatically left and right.

- 2 To stop the blades moving left and right, set the air flow blade swing switch to the **OFF** position.

➤ To stop the blades in a specific position and orient the air flow in the corresponding direction, simply set the switch to the **OFF** position when the blades are in the desired position.

Adjusting the Air Flow Direction Vertically

Again depending on the position of the unit in your room, you can adjust the orientation of the outer air flow blades on the right-hand side of the unit.

RECOMMENDATION	When...	Adjust the blades to face...
	Cooling	Upwards.

Adjust the air flow blades to the desired position, by pushing them upwards or downwards.

- If you orient the air flow blades downwards and the unit operates in Cool mode for long periods of time, dew may:
- ◆ Form on the surface of the blades
 - ◆ Drip from the blades

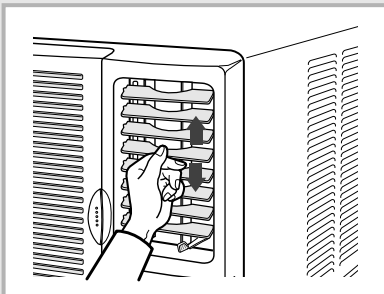

Operating Recommendation

Here is a recommendations that you should follow when using your air conditioner.

Topic	Recommendation
Power failure	If a power failure occurs when the air conditioner is operating, the unit is switched off. When the power returns, the air conditioner starts up again automatically.

Temperature and Humidity Ranges

The following table indicates the temperature and humidity ranges, within which the air conditioner can be used.

Mode	Outdoor Temperature	Indoor Temperature	Indoor Humidity
Cooling	21°C to 54°C approx.	21°C to 32°C approx.	80% or less

If the air conditioner is used at...	Then...
Higher temperature	The automatic protection feature may be triggered and the air conditioner stopped.
Lower temperature	A water leakage or some other malfunction may happen if the heat exchanger freezes.
Higher humidity levels	Water may condense on and drip from the surface of the unit if it is used for long periods.

Cleaning Your Air Conditioner

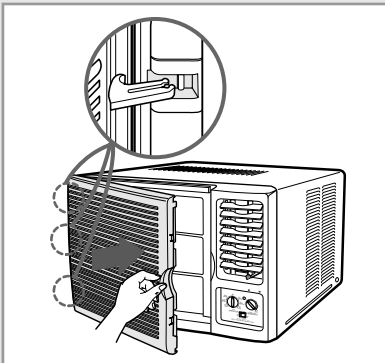
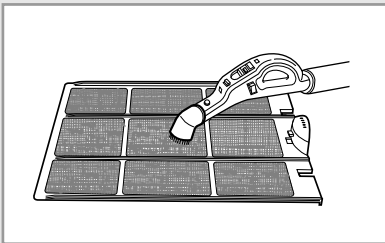
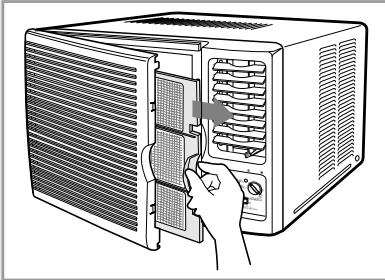

Be sure to clean the air filter periodically two weeks to maintain the air conditioner in the best condition for a long period of time.

IMPORTANT When cleaning the air conditioner, turn it off and pull out the power plug.

- 1 Hold the air filter handle, slightly pull it to the left side and open the front grille.

Note The removal of the front grille makes it easier to clean the air conditioner. Open the grille as much as possible.

CAUTION

Removal and Reassembly of the Front Grille

For user's safety, a safety clip has been installed in the front grille.

- 1 Grasp the lower part of the front grille and the air filter handle, then open the grille.
- 2 Remove the safety clip and the front grille.
- 3 When reassembling the front grille, you should install the safety clip again.

Safety clip

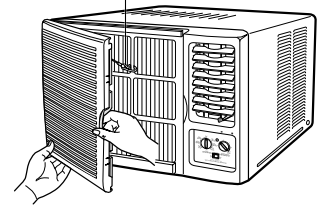

- 2 Pull the air filter to the right side.
- 3 Remove all dust on the air filter with a vacuum cleaner or brush.
- 4 When you have finished, insert the air filter back into its original position.
- 5 Wipe the surface of the unit with a neutral detergent and then wipe it again with dry cloth.
(Be sure not to use benzene, solvent or other chemical products.)

➤ If you...	Then...
Will not be using the air conditioner for a long period of time	<ul style="list-style-type: none"> ◆ Set the fan going for three to four hours to dry the inside of the air conditioner thoroughly. ◆ Switch the air conditioner off and unplug it from the wall socket. ◆ Clean the filter and outer surfaces.
Have not used the air conditioner for a long period of time	Set the fan going for a few hours to dry the inside of the air conditioner thoroughly.

Solving Common Problems

Before contacting the after-sales service, perform the following simple checks. They may save you the time and expense of an unnecessary call.

PROBLEM	EXPLANATION / SOLUTION
The air conditioner does not operate at all	<ul style="list-style-type: none">◆ Check that the circuit breaker used for the air conditioner has not been triggered.◆ Check that the power cable is plugged into a wall socket and the socket is switched on, if necessary.◆ Check that the correct operating mode has been selected (cooling or airing).
The air conditioner does not cool	<ul style="list-style-type: none">◆ Check that the correct operating mode has been selected.◆ The room temperature may be too low.◆ Dust may be blocking the air filter; refer to page 10 for cleaning instructions.◆ Check that there is no obstacle blocking the air flow into or out of the unit.
The air flow direction does not change when you set the air flow blade swing switch to the ON position	<ul style="list-style-type: none">◆ Check that the air conditioner has been switched on; if necessary, turn the operating mode selection dial.
Odours are permeated in the room during air conditioning	<ul style="list-style-type: none">◆ Air the room.

Technical Specifications

Design and specifications are subject to change without notice.

Model	Power Supply
AWT24F1ME AWT24F1MEB/EC AWT18F1ME AWT18F1MEA/EB/EC AWT19F1MEA	220-240V~, 50Hz
AWT24F1MB AWT24F1MBA/BC AWT20F1MB AWT20F1MBA AWT18F1MBB/BC	220V~, 60Hz

Method of Installation

Before installation, be sure to check the installation area for the air conditioner, and installation method of the drain hose.

Checkpoints prior to installation

- 1 Check the cabinet and front grille of the unit for any harmful defects such as scratches.
- 2 Be sure to check the power supply.
- Refer to the specifications on the label attached to the unit.

Installation Conditions

- 1 As the unit is heavy, the wall or window of the installation area should have sufficient strength and durability for operation of the air conditioner, and for prevention of any vibration or noise.
If it is weak, reinforcement work should be performed separately.
- 2 It is advisable to install the air conditioner in the north or west side to prevent the effect of direct sunlight.
When installing it in the south or east side due to unavoidable circumstances, it is advisable to install the sunshade to prevent the direct sunlight.
In this case, take care not to cause any hindrance to the flow of outside air.
- 3 When installing the air conditioner, be sure to obtain sufficient space on the rear side of the unit for smooth flow of air.
When operating the air conditioner in closed areas such as inner building with cooling operation, and result in trouble with the unit.
See the illustration below.

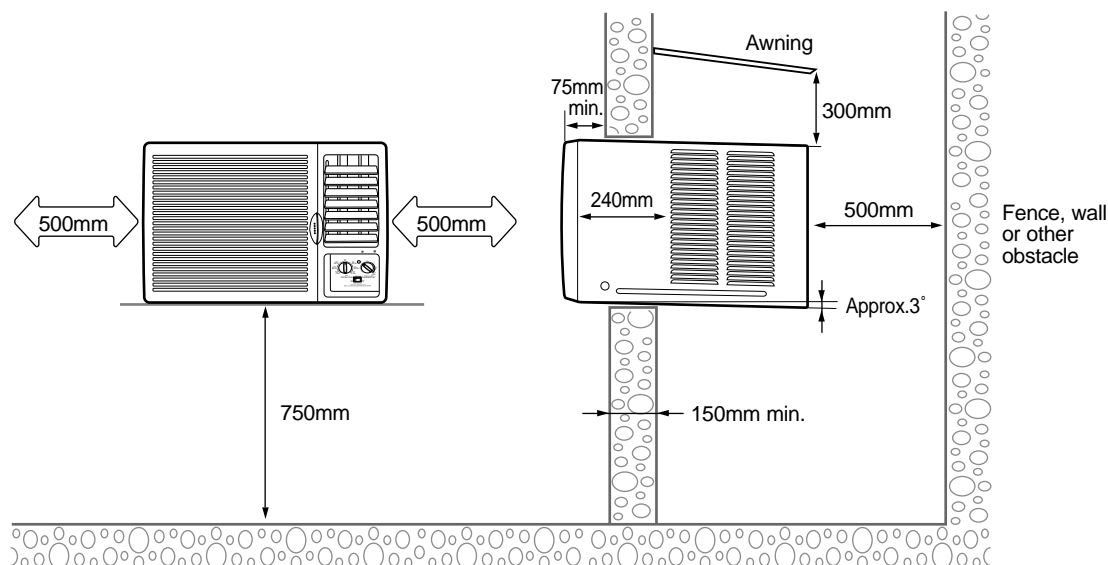

Note ◆ If the wall is greater than 150mm thick, cut the wall back on a 45° angle if possible.

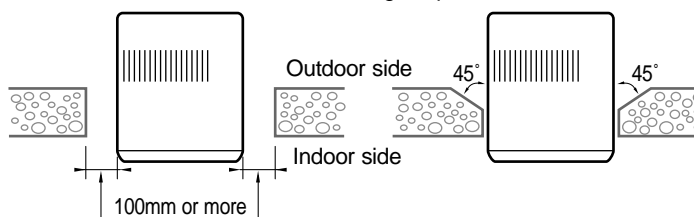

Method of Installation

Installation of the Drain Tube

Fix the drain tube as shown in the figure.

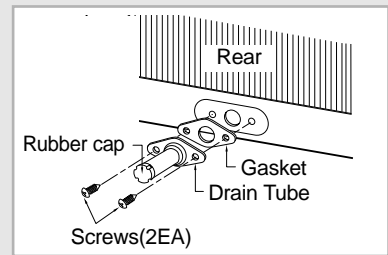

Installation of the Drain Pan

The procedure for installing the drain pan should be determined by the condition of the installing area.

◆ In the case of an area where the drain pan can not be directly installed on the rear side of the unit after installing the air conditioner.

Example: High storage

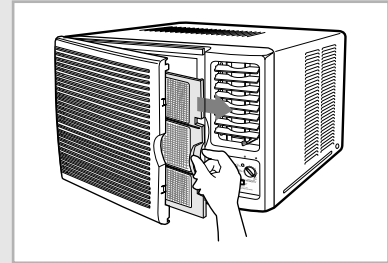

1 Open the front grille.

CAUTION

Removal and Reassembly of the Front Grille

For user's safety, a safety clip has been installed in the front grille.

- 1 Grasp the lower part of the front grille and the air filter handle, then open the grille.
- 2 Remove the safety clip and the front grille.
- 3 When reassembling the front grille, you should install the safety clip again.

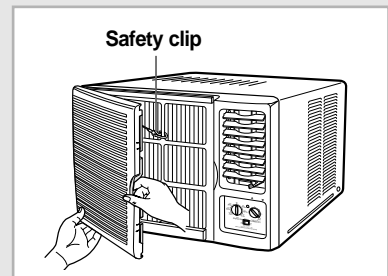

2 Remove the front panel.

2-1 Press both sides of the cabinet in the direction of the arrow as shown in the figure.

2-2 Pull the lower part of the front panel slightly forward. (below three inches)

2-3 Lift the front panel upward.



Applying excessive force to remove the front panel may cause damage to the tab ; be sure not to use excessive force.

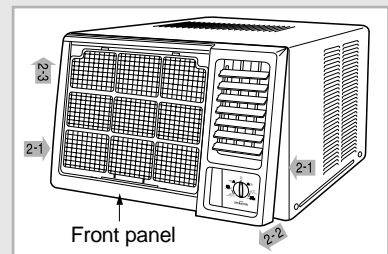

3 Remove two screws on the lower, right and left sides of the unit.

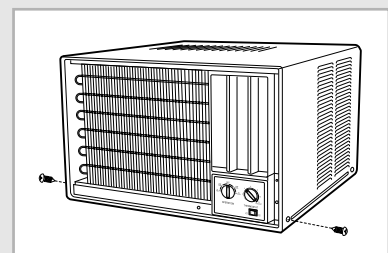

Method of Installation

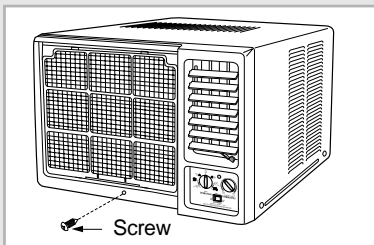
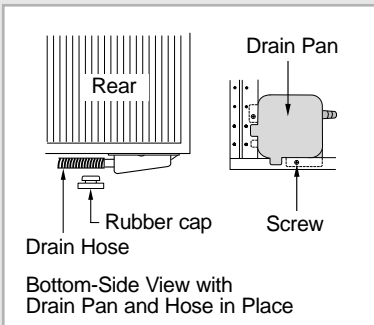

- 4 Remove the chassis from the cabinet.
- 5 Remove the rubber cap inserted into the basepan.
- 6 Fix the drain pan as shown in the figure, and then connect the drain hose. (You can use any commercially-available drain hose.)
- 7 Install the cabinet at the specified area after installing the drain pan, and then re-assemble it in the original condition.
 - * When assembling the front panel be sure to fix with a supplied screw. (TH 2S 4X10)

◆ In the case of an area where the drain pan can be directly installed on the rear side of the unit after installing the air conditioner.

- 1 Follow steps 5 and 6 only.

THIS AIR CONDITIONER IS MANUFACTURED BY:



ELECTRONICS