





NL	Handleiding	2
EN	User manual	36
DE	Benutzerhandbuch	70



PHILIPS

Meaning of symbols

EN

	<p>Important information: Must be read and understood.</p>
	<p>Your product has been designed and manufactured with high quality materials and components, which can be recycled and reused.</p> <p>When this crossed-out wheeled bin symbol is attached to a product or his packaging, it means the product is covered by European Directive 2002/96/EC. Please inform yourself about the local separate collection system for electronic products.</p> <p>Please act according to your local rules and do not dispose of your old products with your normal household waste. The correct disposal of your old product will help prevent potential negative consequences for the environment and human health.</p>
	<p>The “Material recyclability symbol” affixed on package cardboard and user manual means these parts are recyclable.</p> <p>So do not dispose of them with your normal household waste.</p>
	<p>The “Material recyclability symbol” affixed on plastic packaging parts means these parts are recyclable.</p> <p>So do not dispose of them with your normal household waste.</p>
	<p>The “Green Dot” affixed on cardboard means PHILIPS pays a financial duty to the “Avoidance and Recovery of Packaging Waste” organization.</p>

Safety instructions

EN



Your receiver has been manufactured to meet the appropriate safety standards, but the instructions below must be followed to operate it safely. These instructions must be kept for future reference.

- Before connecting the receiver to the mains, check that the mains supply voltage corresponds to the voltage printed on the rear of the receiver. If the mains voltage is different, consult the dealer.
- The receiver does not contain any user-serviceable parts. All maintenance work must be carried out by qualified personnel.
- If you disconnect the receiver from the mains, make sure to unplug it from the wall socket and not just from the AC socket at the back of the unit. Children could seriously injure themselves, as the free end of the cable is still alive.
- Unplug the receiver during lightning storms.
- To prevent fire or shock hazard, do not expose this equipment to rain or moisture.
- The receiver should be placed on a firm surface, and the ventilation openings must not be covered with items, such as newspapers, table clothes, curtains, etc.
- Do not install the receiver near any heat sources such as radiators, stoves or other apparatus that produce heat. Protect it from direct sunlight.
- When installing the receiver, ensure there is a gap of approximately 2.5 cm around the receiver to enable air to circulate freely and prevent overheating.
- Leave accessible the mains connector at the back of the unit in case emergency shutdown is required.
- Do not place any combustible objects on the receiver (candles, etc.).
- No objects filled with liquids, such as vases, shall be placed on the unit. The receiver shall not be exposed to dripping or splashing. Should this happen, disconnect your receiver from the mains and consult your dealer.
- Make sure that children do not place any foreign objects in any of the openings.
- For cleaning, use a soft, damp (not wet) cloth. Never use any abrasive cloth and aerosol cleaners.

Unpacking the receiver

EN

As you unpack your terminal, make sure the following accessories are included:

- 1 x Remote Control Unit
- 2 x AA batteries
- 1 x SCART Cable
- 1 x Power Cord
- 1 x Antenna Cord type F-IEC
- 1 x Adapter F male-IEC female
- 1 x Sticker to be put on your smart card
- 1 x Leaflet explaining what to do with the adapter and sticker mentioned above
- 1 x User Manual
- 1 x Worldwide Warranty booklet



Plastic bags can be dangerous. To avoid suffocation keep the bag away from babies and children.

Quick installation guide

Refer to the safety section before connecting your terminal.

- 1 Disconnect your TV set and recorder from the mains.
- 2 Screw the adapter supplied with your receiver on the “RF IN” connector of the rear panel.
- 3 Integrate your terminal in your existing installation as shown on the diagram.

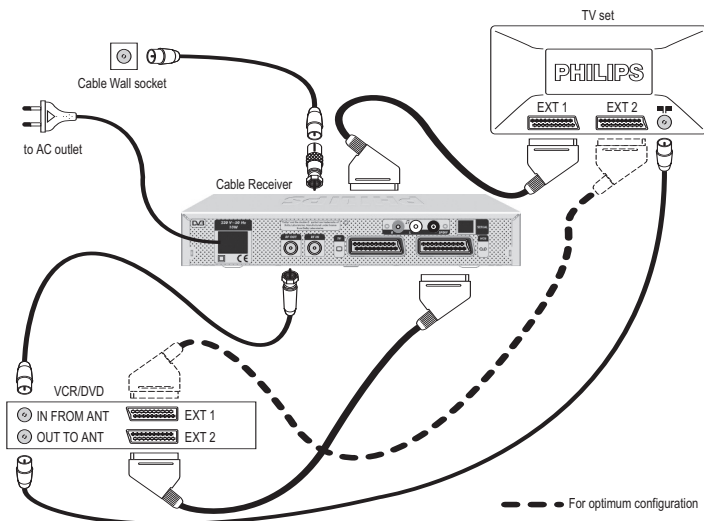

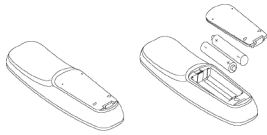
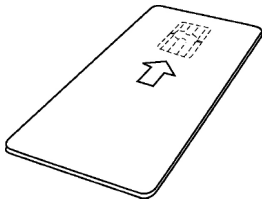

- 4 To avoid incorrect insertion of the smart card in the slot, make sure you affix the reminder sticker supplied with your receiver on the smart card so as to cover the following text: "Deze zijde boven" (on the side that has no chip).
- 5 Insert your smart card in your receiver with the golden or silver contacts facing up.
- 6 Insert the two batteries supplied in your remote control.

Batteries are removable from the remote using common household tools (like a screwdriver,...). The batteries supplied do not contain hazardous substances such as Mercury, Cadmium, or Lead. However, they must not be disposed of with your household waste but to a local separate collection system.

- 7 Reconnect your TV set and recorder to the mains. Do not connect your receiver yet!
- 8 Switch on your TV set and select a channel.
- 9 Plug the receiver's power cord to the mains. The welcome screen appears, then the First installation screen.

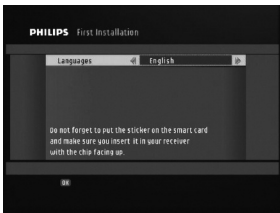

- 10 Set your favourite menu language and press **OK**.
- 11 Set appropriate values for the following:
 - **Network ID:** applicable network ID as indicated by your operator. Please see operator booklet for the right decimal value to be entered for your region.
 - **Frequency:** broadcast frequency predefined or entered manually as indicated by your operator (please see operator booklet).
 - **Symbol Rate:** predefined value, which should not be modified unless requested by your operator
 - **Modulation:** predefined modulation type, which should not be modified unless requested by your operator



 Symbol rate and modulation may be modified manually upon request by your operator.

- 12 Press **OK** to start scanning for channels.

When scanning has been successfully completed, a completion message is displayed, and then the receiver tunes to the first channel in the list.

Contents

EN

- 36 Meaning of symbols**
- 37 Safety instructions**
- 38 Quick installation guide**
- 38 Unpacking the receiver**
- 42 Introduction**
- 43 Product description**
 - 43 Front panel
 - 44 Rear panel
- 45 Remote control**
- 46 Inserting your Smart Card**
- 47 Connecting your receiver**
 - 47 Connecting to TV and VCR/DVD player using SCART Support
 - 48 Connecting to your audio equipment
- 49 First installation**
 - 49 First installation settings
 - 49 Channel scanning
 - 50 Scanning failure
- 51 General Viewing Functions**
 - 51 Receiver wake up
 - 51 Channel selection
 - 52 Channel banner
 - 52 Channel Lists
 - 52 TV or Radio mode selection
 - 53 Volume & Audio Control
 - 53 Recording timers
 - 55 Guide (Electronic Programme Guide)

56 Settings

- 56 Menu
- 56 Favourites lists
- 59 Conditional access
- 60 User preferences
- 61 Setup
- 62 System information

63 Menu Tree

64 More about recording (VCR or DVD control)

- 64 Connection for Easy Recording
- 65 Digital receiver and VCR or DVD settings
- 65 Recording with the VCR control feature

66 Troubleshooting

68 Technical specifications

Introduction

EN

Welcome to digital television!

The Philips Digital Cable Receiver DCR 2020 allows you to view a wide variety of free-to-air and scrambled channels with the best digital picture and sound quality.

With this product you can enjoy advanced functions and features including:

- Digital picture and sound quality
- Wide screen format
- TV SCART and VCR/DVD SCART connector
- Up to 500 presets for TV and Radio channels
- Easy installation and use through the well-tested Euphoria User Interface
- Personal channel list and favourite lists
- Electronic Programme Guide

This user manual covers the installation of your receiver and the necessary steps to use the various functions, so you can optimally enjoy every feature.

A handwritten signature in black ink, appearing to be 'Lucas Covers', written over a diagonal line.

Lucas Covers, CEO BLC Digital Video STB
Paris, July 2005

Product description

Front panel

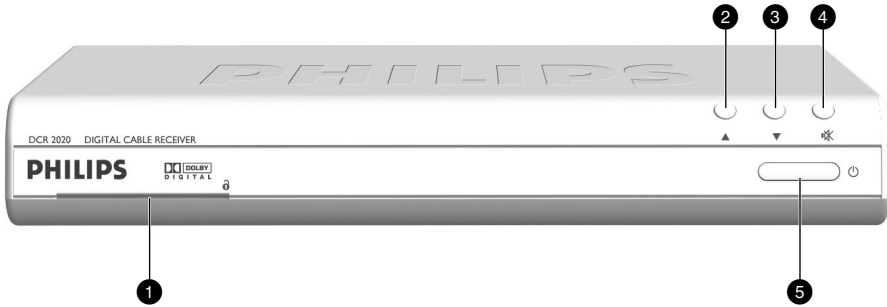

- 1 Smart Card slot: see chapter Inserting your Smart Card
- 2 ▲ channel +
- 3 ▼ channel -
- 4 🚫 mute/demute
- 5 ⏻ ON/"low power"

The front panel ⏻ button hides the remote control receiver window and includes two LEDs indicating the receiver status. One of the LEDs blinks at remote control command reception.

Receiver operating mode	LED1	LED2
Low Power	red	off
Standby	off	red
Running in TV mode	off	green
Running in Radio mode	off	orange
TV recording in progress	red	green
Radio recording in progress	red	orange
Recording ongoing during standby	red	red
Download in progress	blinking red	off

If the red LED is blinking continuously, it indicates that an upgrade of your terminal software is taking place. Do not interrupt this operation. Wait for the green LED to light up, indicating successful upgrade, and then continue as normal.

Rear panel

EN

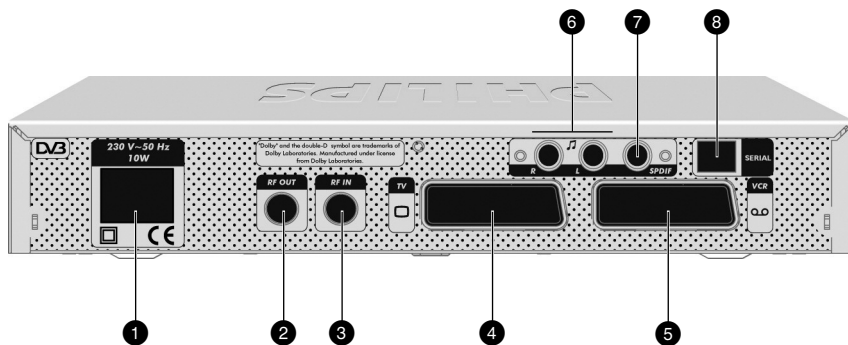

- 1 230V~50Hz 10W max (**): Socket used to connect the power cord.
- 2 RF OUT (*): RF output used to connect your receiver to a VCR/TV set to watch analogue channels only, or to connect another receiver using the adapter supplied with your receiver.
- 3 RF IN (*): RF input used to connect the cable from the wall socket. Refer to chapter Connecting your receiver.
- 4 TV (*): SCART (1) socket used to connect to your TV set.
- 5 VCR (*): SCART (1) socket used to connect your video recorder or DVD player/recorder.
- 6 L/R (*): Left/Right analogue audio cinch outputs used to connect your HiFi/audio receiver system.
- 7 SPDIF (*): Digital audio cinch output used to connect your HiFi/audio receiver system.
- 8 SERIAL (*): RS232 socket used for serial data transfer.

The label showing the type and serial number is underneath the receiver.

(1) SCART is also called Euroconnector or Peritel.

* Safety Extra Low Voltage

** Hazardous Voltage

Remote control

EN

0-9 number keys

- In TV/radio mode: select channels
- In menu: directly select a menu item or set a setting
- In standby: wake up the receiver

INFO

Switch between normal viewing, Channel Banner, and Channel Banner with Extended Info

EXIT

Return to normal viewing

VOLUME +/-

Increases/Decreases the volume level

MUTE

Mute/Demute the sound on your TV or receiver

RED, GREEN, YELLOW, BLUE

Contextual keys

TV/STB

Toggle between watching digital TV via your receiver and standard analogue TV via your TV set

I-II

Open the Audio Languages screen to momentarily change the soundtrack and audio mode

MENU

Opens/Closes the Menu

REC

Open/Close the Timer screen

Standby

Switch your receiver into the standby mode.

EPG

Opens/Closes the Programme Guide

BACK

- In TV/radio mode: return to the previously tuned channel
- In menu mode: return to the previous screen.

CURSOR /

- Switch the Channel Banner in the browsing mode.
- Scroll up/down in a menu or channel list

CURSOR /

In Channel Banner: switch between the current and next programme

OK

Confirm your choice

P+ / P-

- In TV/radio mode: tune the next/previous channel within the current channel list.
- In standby: wake up the receiver

TEXT

In TV/radio mode: enable/disable text display

SUBTITLE

Open the Subtitles Language screen to momentarily change subtitles language

FAV

Open/Close the current channel list

RADIO

In TV/radio mode: toggle between TV and Radio

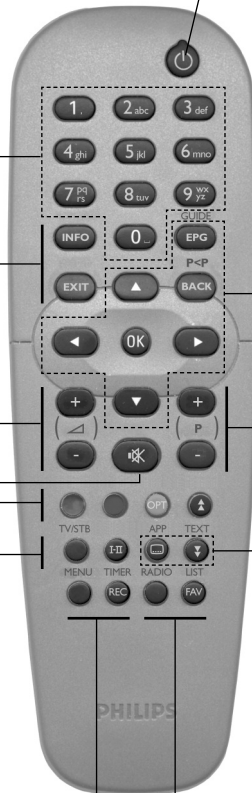

Inserting your Smart Card

EN

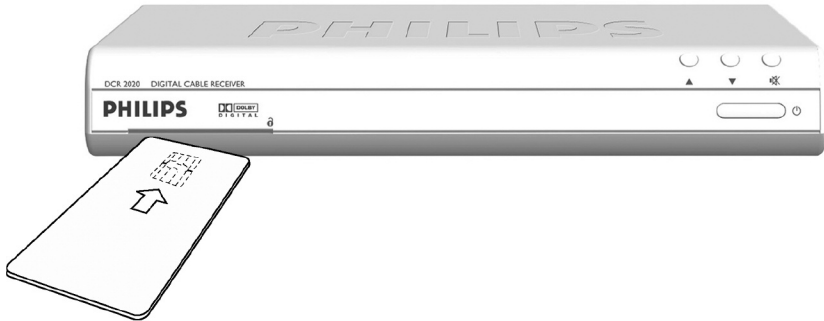

To be able to receive scrambled digital channels specific to an operator, you need a smart card from that operator. Your operator may update it from time to time.

To avoid incorrect insertion of the smart card in the slot, make sure you affix the reminder sticker supplied with your receiver on the smart card so as to cover the following text: “Deze zijde boven” (on the side that has no chip).



Insert the smart card with the chip facing up.

Push the smart card into the slot as far as it will go. The end of the card will be visible outside the slot.

New and updated information may be downloaded onto the smart card from time to time.

Connecting your receiver

There are several ways you can connect and incorporate your digital receiver into your existing audio/video equipment set up.

⚠ Before starting to connect:

- Unplug all equipment (TV set as well as VCR and/or DVD or DVD+R if required) from the mains.
- Do not connect your digital receiver to mains supply now.
- Check your current wiring: you may not need to modify your existing audio/video set up connections if they already match the connection diagrams below.
- Depending on your exiting set up, choose the best suited connection method for incorporating your digital receiver.

When adding new equipment, be sure to refer to the related installation instructions of the manual of the respective devices.

Connecting to TV and VCR/DVD player using SCART Support

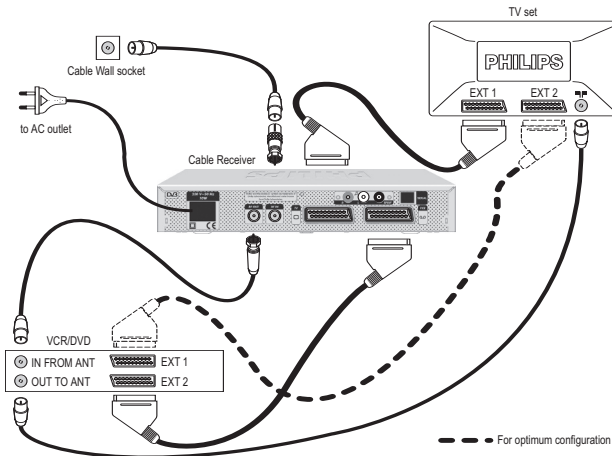

Screw the adapter supplied with your receiver on the “RF IN” connector of the rear panel. Use the antenna cord type F-IEC supplied to connect your receiver to the VCR/DVD. Use the SCART cable supplied to connect your receiver to the TV set.

For best DVD/VCR viewing, connect the DVD/VCR SCART EXT 1 directly to the TV set SCART.

Connecting to your audio equipment

EN

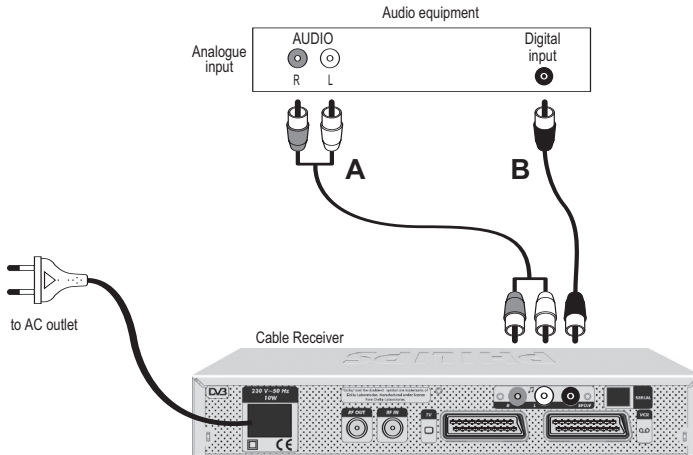

Analogue connection (A)

Connect the L/R audio output sockets to the relevant L/R audio input sockets of your audio equipment using a double CINCH cable (not supplied). Consult the user manual of your audio equipment to choose the proper analogue audio inputs.

Digital connection (B)

Connect the audio “**SPDIF**” output socket to the relevant digital audio input socket of your audio equipment using a single CINCH cable (not supplied). Consult the user manual of your audio equipment to choose the proper digital audio input.

With this connection set up you can only control the audio volume up/down and mute from your audio equipment.

First installation

For fast and successful start-up, check that your receiver is connected to the wall socket, TV set and other equipment according to the diagrams in chapter Connecting your receiver. Switch on the receiver and TV set. The welcome screen appears, then the First installation screen.

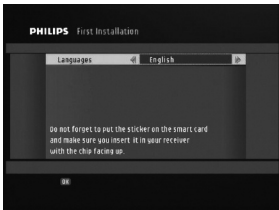

First installation settings

- Set your favourite menu language and press **OK**.
- Set appropriate values for the following:
 - **Network ID**: applicable network ID as indicated by your operator. See operator booklet for the right decimal value to be entered for your region.
 - **Frequency**: broadcast frequency predefined or entered manually as indicated by your operator (see operator booklet).
 - **Symbol Rate**: predefined value, which should not be modified unless requested by your operator
 - **Modulation**: predefined modulation type, which should not be modified unless requested by your operator



Symbol rate and modulation may be modified manually upon request by your operator.

- Press **OK** to start scanning for channels.

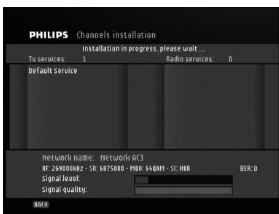

Channel scanning

During the scanning process, the following information is reported on screen:

- number of TV and Radio channels detected,
- name of the network detected,
- level and quality of reception of the signal.

When scanning has been successfully completed, a completion message is displayed, and then the receiver tunes to the first channel in the list.

Scanning failure

In case of channel scanning failure, a failure message is briefly displayed, and then the main menu appears (in case of first attempt). Select Setup then Channels installation, and proceed as described in paragraph Channels installation to launch a new scan.

If installation fails again, the Setup sub menu appears; select Channels installation, and proceed as described in paragraph Channels installation.

Before starting a new scan

It is recommended to do the following checks:

- connections to your receiver (see chapter Connecting your receiver)
- number of channels available in the region corresponding to your area.
- network settings provided by your operator (see operator booklet)

If the same failure message appears after a while, refer to chapter Troubleshooting. Contact your cable operator if the problem remains.

General Viewing Functions

EN

This section describes the basic functions available while watching digital TV or listening to digital radio. For general menu navigation, see Settings.

Receiver wake up

Your receiver is in “low power”. The only way to wake it up is to press **⏻** on the front panel.

Your receiver is in standby. Press **P+**, **P-**, or any number key of the remote control. Alternatively, press **▼** or **▲** on the front panel.



Your receiver, as any electronic equipment, consumes power. In order to reduce power consumption, please switch your receiver to standby whenever you are not using it.

For maximum energy saving we recommend you switch off the receiver by unplugging it from the mains if you are not using it for a long time.

Channel selection

Using P+/P- or number keys

To change channels, use **P+/P-** or the number keys of the remote control.

Previous Channel Recall

Press **BACK** to move to the previous channel you watched in the current channel list.

Using the channel list

To view the list of all available channels while watching digital TV or listening to digital radio, press **OK**.

If you press **BACK**, the channel list disappears.

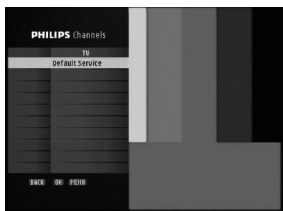

To select a channel:

- Scroll up or down to the desired channel.
- Press **OK**. The current programme is displayed in the background.
- Press **OK** again to close the list.

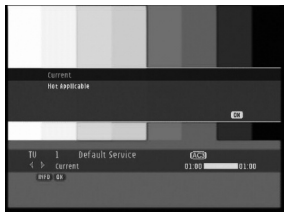

Channel banner

Every time you tune to a channel, the channel banner appears, displaying information on this channel, including information on the current programme.

The channel banner is displayed for 5 seconds as per default. This can be adjusted from the Appearance item of the User Preferences sub menu.

icon description

	alternate audio language/format
	current favourite list
	maturity rating locked
	scrambled channel
	locked channel
	subtitles presence
	teletext presence

While watching a channel, you can display the current channel information at anytime by pressing **INFO**. Press **INFO** again to get more information about the current programme. Press **INFO** a third time to close the channel banner

Channel Lists

While watching digital TV or listening to digital radio, you can access existing channel lists by pressing **FAV**. Successively press **FAV** to toggle between the favourite lists you created and the list of all available channels. The current channel list is indicated on the left-hand side of the banner.

When one of the favourite lists is activated, you zap only through the channels this list contains.



To create and edit your favourite lists, see paragraph Favourites lists.

TV or Radio mode selection

While watching digital TV or listening to digital radio, press **RADIO** to toggle between TV and radio modes.

Volume & Audio Control

Volume control and Mute

To decrease or increase the volume, use  .
The volume level can also be controlled from your TV.
To mute the sound, press .

EN

A change of volume is signalled on-screen using a bar graph, while audio mute is signalled with an icon in the top right corner of the screen.

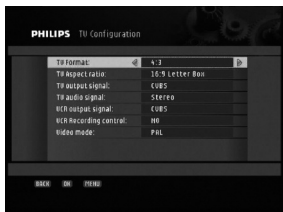

Audio mode

To access audio settings:

- select Setup from the main menu, then select TV configuration.
- Scroll to TV audio signal and set the desired value (Stereo, Mono, or Dolby digital).
- Press **OK** to save your changes and exit the screen.

Audio language

To select your preferred audio language:

- Select User preferences from the main menu, then select Languages.
- Scroll to Audio Language and set the desired language.
- Press **OK** to save your changes and exit the screen.

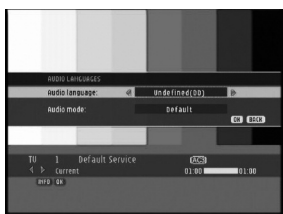

If you want to change the audio mode or language for a particular programme, press **I-II** to directly access the audio options available for this programme. Available languages depend on the audio content transmitted.

Recording timers

Recording timers are used for VCR or DVD recordings.

Setting a timer from the Guide

- Select Guide from the main menu, or press **GUIDE**.
- Move to the desired programme using the arrow keys.
- Press **TIMER** to set a recording timer on the selected programme.
- Enter your PIN code if necessary, and then set the timer as appropriate. By default, the settings correspond to the selected programme.
- Press **OK** to confirm.

Setting a timer while watching digital TV or listening to digital radio

- Press **TIMER**.
- Set the desired Timer type: Recording timers, Reminders, or Sleep Timer, and then press **OK**.
- Set the values of the recording parameters using the arrow or number keys as appropriate (for more details, refer to paragraph Recording timers and Reminders).
- Press **OK** to confirm.

Setting a timer from the Timers sub menu

- Select the Recording timers item from the Timer sub menu.
- Select Add timer.
- Set the values of the recording parameters using the arrow or number keys as appropriate (for more details, refer to paragraph Recording timers and Reminders).
- Press **OK** to confirm.

Deleting an active timer

A timer is active. Recording is signalled by two front LEDs: the right hand one lit in red and the left hand one lit in green in TV mode or in orange in Radio mode, or both LEDs lit in red if your receiver is in standby.

To delete the active timer:

- If your receiver is in standby, press **P+**, **P-**, or any number key of the remote control.
- Press the key sequence **TIMER** then **0**. The red light then switches off and you can change channels.

When a recording timer is active, you cannot change digital channels, but you can switch to analogue TV using the **TV/STB** key and zap through analogue channels.

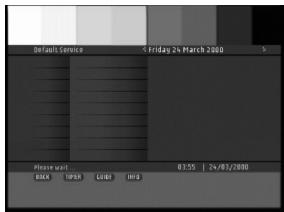

Guide (Electronic Programme Guide)

The TV/Radio Electronic Programme Guide (EPG) provides an overview of available TV and Radio channels, and programmes the broadcasters have scheduled, starting with the current programme.

EN

To view EPG data:

- Press **GUIDE** when watching a channel, or select Guide from the main menu.
- Highlight the name of the programme for which you want more detailed information.
- Press **INFO** once to get extended information (programme description), and once again to close it.
- Press **OK** to view the corresponding channel.

A 'No information yet' message is displayed if the selected channel does not provide EPG data. It may take a few seconds before data can be displayed.

Settings

EN

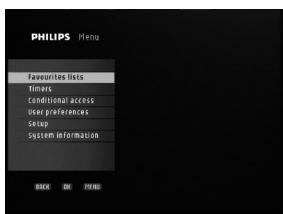

Menu

Basic navigation

While watching digital TV or listening to digital radio:

- Press **MENU** to display the main menu.
- Press **▲** or **▼** to scroll up or down to the menu item you want to select.
- Press **OK** to display the corresponding sub items.
- Press **▲** or **▼** to move to the desired sub item.

Press **MENU** to go back to the main menu or **BACK** to go back one step in the menu, or **EXIT** to return to normal viewing.

Changing settings

Once you highlighted an adjustable item or sub item, you can then access the values and make changes using the **◀** or **▶** key to select an option or number keys to enter numerical values.

To open a locked menu item (indicated by a (L) icon), you need to enter your PIN-Code.

Cancelling/storing changes

- Either press **EXIT** to exit the menu system without storing changes.
- Or press **OK** to validate changes and exit the screen.

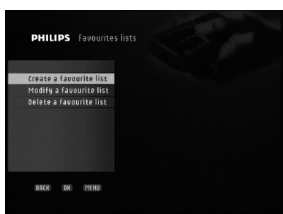

Favourites lists

At installation, all the channels found are added to the “TV” or “RADIO” list. From these two lists, you may create favourite lists according to your preferences.

Favourites lists is used to

- create, modify and delete lists of favourite channels
- Lock channels

To create a favourite list:

- Select Create a favourite list from the Favourites lists sub menu.

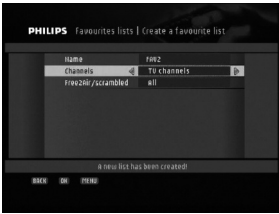

- Set the type of channels you want to list:
 - Channels: TV channels or Radio channels
 - Free2Air/scrambled: All, Scrambled, or Free2air
- Press **OK** to display the list of channels matching the above criteria.
- Modify your favourite list as described below.

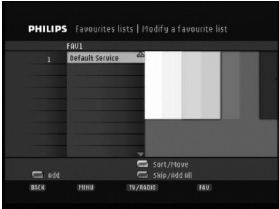

- To modify a favourite list:
- Select Modify a favourite list from the Favourites lists sub menu.
 - Select the list you want to modify.
 - Modify your favourite list:



- Use the green colour button to individually select the channels you want to add to the current list. Selected channels are marked with a tick.
- Use the blue colour button to access the Skip all/Add all features, then use the green colour button to add all available channels to the current list, or the red colour button to remove all channels from this list.
- Use the yellow colour button to access the Sort/Move features, then use the red colour button to perform an automatic alphabetical sort or the green colour button to manually move individual channels.
- Use the red colour button to lock or unlock channels belonging to the list. If you lock a channel belonging to several lists, it is locked in all the lists. Locked channels are marked with a lock icon.

If you have selected the “TV” or “Radio” list, only the lock/unlock feature is available.

- Press **MENU** or **BACK** to exit the screen. You are then prompted to confirm your changes.

To delete a favourite list:

- Select Delete a favourite list from the Favourites lists sub menu.
- Select the list you want to delete.
- When prompted, press **OK** to confirm deletion.
- Press **OK** to return to the Favourites lists sub menu.

When you activate one of the favourite lists by pressing **FAV** while watching digital TV or listening to digital radio, the receiver only zaps through your favourite channels. Press **FAV** to again toggle between your favourite lists and the full channel list.

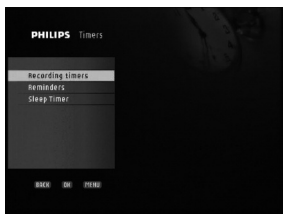

Timers

Timers is used to set and edit:

- recording timers for the programmes you want to record using your VCR or DVD recorder,
- reminders to receive a warning and automatically change channel before the start of programmes you want to see,
- sleep timers.



To be able to record a digital channel using a VCR or DVD recorder, you must set both your recorder and receiver:

- You must set a timer on your receiver.
- You must also enable recording on the VCR or DVD recorder, either by enabling an Easy Recording option or by programming your recorder (refer to chapter More about recording (VCR or DVD control) and to the VCR or DVD recorder user manual).

Recording timers and Reminders

Add a recording timer or a reminder:

- Select Recording timers or Reminders depending on the type of timer you want to set.
- Select Add timer.

To add a timer, you may also press **TIMER** while watching digital TV or listening to digital radio, or press the appropriate colour key from the Guide.



- Set values for the following:
 - **Date:** set the date using the number keys. If you added the timer from the Guide or using the **TIMER** key, the date is already set to the current day.
 - **Repeat:** set Once for a single recording, Monday/.../Sunday to record on such day every week, Week-end to record on both Saturday and Sunday every week, Weekdays to record from Monday to Friday every week, or every day to record once every day
 - **Start time:** set a start time using the number keys
 - **Stop Time:** set a end time using the number keys
 - **Channel:** current channel. Alternatively, press the green colour key to display the list of available channels. Then scroll to the channel on which the

- programme you want to record is broadcast using the ▲ or ▼ key, and press **OK** to select it.
- Press **OK** to confirm.

When a recording timer is active, you cannot change digital channels, but you can switch to analogue TV using the **TV/STB** key and zap through analogue channels. To delete an active timer, press the key sequence **TIMER, 0**.



- Modify an existing timer before its activation:
- Select Modify timer from list from the Recording timers or Reminders sub menu depending on the type of timer you want to modify.
 - Select the timer you want to modify from the list.
 - Modify the appropriate settings.
 - Press **OK** to confirm.

- Delete an existing timer:
- Select Delete timer from list from the Recording timers or Reminders sub menu depending on the type of timer you want to delete.
 - Scroll to the timer you want to delete from the list.
 - Press **OK** to confirm.

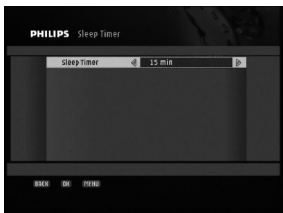

Sleep timer

You can set a sleep timer to automatically switch your receiver to Standby mode after a given time lapse.

- Set a sleep timer:
- Select the time lapse after which the receiver should go to Standby (up to 3 hours) using the ◀ or ▶ key.
 - Press **OK** to confirm.

- Disable a sleep timer:
- Select OFF instead of a time lapse.
 - Press **OK** to confirm.



Conditional access

Conditional access is used to view information on your receiver and smart card, including the receiver and smart card version. It is also used to change your receiver PIN code.



The PIN code default value is 0000.

Changing PIN code:

- Scroll to Changing PIN code, and then press **OK**.
- Enter your current PIN code and press **OK**.
- Enter your new PIN code and press **OK**.
- Enter your new PIN code again and press **OK**.

Once you have changed your Pin Code, keep it secret to prevent others from using it. If you forget or lose your Pin Code, call your customer service adviser.

User preferences

User preferences is used to

- Set the language and on screen display options according to your preferences
- Enable and set up Parental control



Languages

- Set values for the following:
 - **Menu Language, Audio Language, and Subtitles Language**
 - **Subtitles Mode:** Translation, Hearing impaired, or Off
- Press **OK**.

On-screen display

- Set values for the following:
 - **Banner timeout:** banner display duration, from 3 to 10 seconds in steps of 1 second
 - **Volume bar display:** Yes or No
 - **Volume bar timeout:** volume bar display duration, from 3 to 10 seconds in steps of 1 second
- Press **OK**.

Access Control

Access control is used to enable and set up parental control options. To access this screen, you must enter your PIN code.

- Set appropriate values for the following:
 - **Parental control:** Enabled or Disabled
 - **Receiver lock, Setup menu lock, and Channel lock:** select to Yes to enable PIN code protection in order to prevent undesired use
 - **Maturity level:** set a level from 1 to 18 to prevent access to programmes which maturity rating is higher
- Press **OK**.



Setup

Setup is used to:

- Install channels
- Test signal level and quality
- modify the general settings of your receiver
- check for software updates
- restore the receiver factory settings.

Access to this menu can be protected by Pin Code.



Channels installation

- Select appropriate values for the following:
 - **Network ID:** applicable network ID as indicated by your operator. See operator booklet for the right decimal value to be entered for your region.
 - **Frequency:** broadcast frequency predefined or entered manually as indicated by your operator (see operator booklet).
 - **Symbol Rate:** predefined or entered manually as indicated by your operator.
 - **Modulation:** modulation type predefined or entered manually as indicated by your operator.



Symbol rate and modulation values should not be modified unless requested by your operator.

- Press **OK** to start scanning for channels.

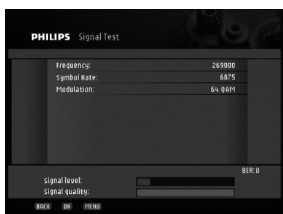

Signal Test

Signal Test is used to view the signal level and quality for the frequency defined at installation.

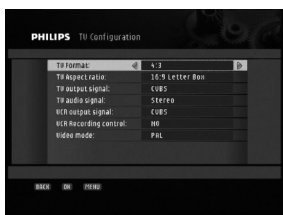

TV Configuration

Select appropriate values for the following:

- **TV Format:** 4:3 or 16:9
 - **TV aspect ratio:** full format, 16:9 Letter Box, 4:3 Center
 - **TV output signal:** CVBS, RGB, or SVideo
 - **TV audio signal:** Stereo, Mono, or Dolby Digital.
 - **VCR Video Output:** CVBS or SVideo
 - **VCR Recording control:** NO, PREPARE RECORD, or RECORD LINK. See chapter More about recording (VCR or DVD control).
 - **Video mode:** PAL or SECAM
- Press **OK** to store the settings.



Software Upgrade

Software upgrade is used to check for new software availability.

If new software is available:

- Press **OK** to accept the upgrade. The receiver restarts.

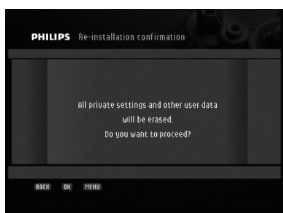

Factory Settings

Factory settings is used to restore the receiver factory configuration.

- Press **OK** when prompted to confirm.

If you reset your receiver to factory settings, you lose all data and information previously stored, and you have to restart first installation.



System information

System information is used to display the receiver reference, software and hardware ID, as well as Total running time in hours.

Menu Tree

EN

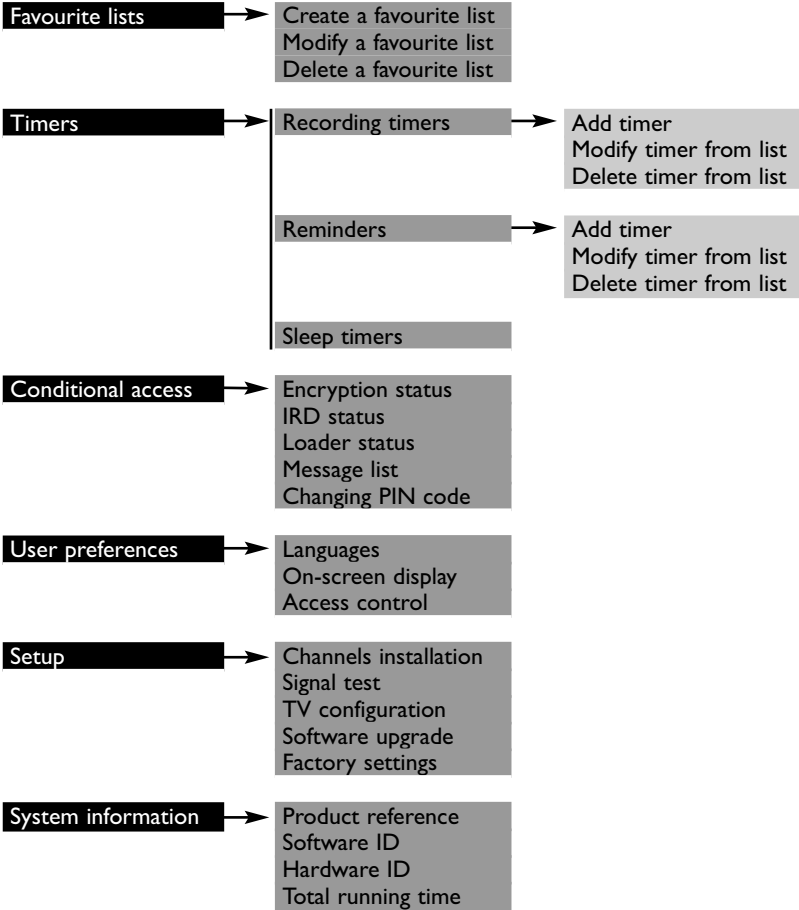

More about recording (VCR or DVD control)

EN

Connection for Easy Recording

This connection allows automatic recording without requiring you to program your VCR or DVD recorder. You must, however, set a timer on your receiver as described in paragraph Timers.

Prior to choosing this connection method:

- Consult the user manual of your VCR or DVD recorder to check if and how this feature is supported. Most Philips VCR and DVD recorders support one of the two Easy Recording options.
- Check that your TV and VCR or DVD are both fitted with two SCART sockets.
- Incorporate your receiver in your existing installation as shown below:

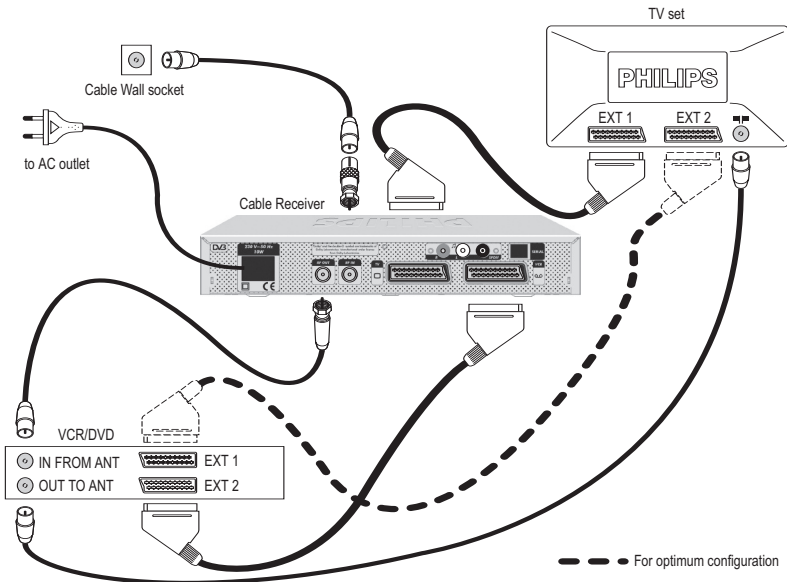

- Screw the adapter supplied with your receiver on the “**RF IN**” socket of the rear panel.
- Connect the receiver “**RF IN**” socket (with adapter) to the cable wall socket.
- Connect the “**RF OUT**” socket of your digital receiver to the aerial input socket of your VCR or DVD using the antenna cord type F-IEC.
- Connect the “**RF OUT**” socket of your VCR or DVD to the aerial input socket of your TV using a RF coaxial lead.

- Connect the “**TV**” SCART socket of your digital receiver to the EXT1 SCART socket of your TV using the SCART lead supplied with your digital receiver.
- Connect the “**VCR**” SCART socket of your digital receiver to the EXT2 SCART socket of your VCR (called “IN”) using a SCART lead.
- Connect the EXT1 SCART socket of your VCR (called “OUT”) to the EXT2 SCART socket of your TV using a SCART lead.
- Plug all your equipment, excluding your digital receiver, into the mains.
- Switch on your TV set and select a channel.
- Plug your receiver into the mains. The welcome screen appears, then the First installation screen (the right hand LED is lit in green).
- Read the Quick installation guide to proceed with the channel scan if not already done.

With this connection set up:

- You can watch digital TV while you record analogue TV.
- You can watch analogue TV while you record digital TV.
- You can record the digital TV channel you are watching.

Some VCR or DVD recorders need to be in standby to use the Easy Recording feature. Refer to your VCR or DVD User manual.

Digital receiver and VCR or DVD settings

Refer to chapter More about recording (VCR or DVD control) for information on how to enable the “Easy Recording” function on your digital receiver.

- Depending on your VCR or DVD brand and type, you have to set the VCR recording control option to “Prepare Record” or “Record Link”. Refer to the VCR or DVD User manual or try the two options to find out which is most suitable.
- Set your VCR or DVD to the mode allowing control by your digital receiver.

Recording with the VCR control feature

- Your digital receiver, TV and VCR or DVD are connected and set according to the diagram.
- You have programmed a timer on your digital receiver as described in paragraph Timers.
- At timer start, your VCR or DVD starts recording and at timer end, it stops recording under the control of your digital receiver. You no longer need VCR or DVD programming to record digital TV channels.

Troubleshooting

EN

Problem	Possible cause	Action
The display on the front panel does not light up.	Faulty power supply	Check that the power cord is correctly connected. Disconnect this cord and reconnect it to ensure it is in place.
		Check that the power is available at the wall socket.
No sound or picture but the front panel red light is on.	Receiver in standby or "low power"	Press P+ , P- , or any number key of the remote control. If the receiver does not wake up, press  on the front panel.
No sound or picture but the front panel green light is on.	Poor signal	Check the connections at the wall socket and receiver.
	Receiver in TV mode	Press TV/STB on the remote control once or twice.
	Poor SCART connections	Check the SCART connections.
The remote control does not operate your receiver.		Make sure the receiver is on.
		Make sure you are pointing your remote control at the receiver front panel.
		Check the batteries in your remote control.
On-screen display working but there is no reception	Poor reception/signal	Check the installation.
Intermittent reception	Faulty connections	Check all connections and cable.
The picture is not sharp and on-screen text is difficult to read.	TV SCART output format not set to RGB	Change setting of the TV output signal item to RGB from the TV Configuration screen.
	TV SCART not connected to the RGB capable SCART socket of your TV set	Refer to your TV User Manual.
	Inappropriate TV SCART	Use the SCART cable supplied with your receiver.
You cannot find all the channels you think should be available.	The signal may be weak.	Try retuning your receiver, following the relevant steps in paragraph Channels installation. If you are still missing channels, call your customer service adviser.

Problem	Possible cause	Action
The picture on some channels seems to have been stretched or squashed.	The broadcast is probably in wide screen and the receiver settings may not be correct.	Check the receiver TV format setting, following the information in paragraph TV Configuration. If you have a wide screen TV, you may also need to check the settings on your TV.
Even if you use the number buttons, you cannot access a particular channel.	The parental lock has been activated on this channel and a message asks for your PIN code.	Enter your PIN code to access the channel or unlock it. The default Pin code is 0000.
You set a timer but did not record what you wanted.	The recorder was set incorrectly.	Make sure that your recorder is set for the same time as your receiver.
The order of the channels has changed.	They have been re-arranged.	Refer to paragraph Favourites lists to change the order again.
You have forgotten your default PIN code		The default PIN code is 0000.

If you have tried all of the actions suggested above and could not solve the problem, contact your customer service adviser.

Technical specifications

EN

This product is in conformity with European Directives 95/47/EC and 2002/21/EC.

System Specifications

- CPU/Video graphics:
8 MB SDRAM
- Flash memory size: 2 MB
- Video decoding:
MPEG-2 DVB up to MP@ML,
Video bit rate up to 15
Mbit/s, Video format 4:3 and
16:9, resolution up to
720x576 pix
- CPU speed: 60 MHz
- Ram size: 8 MB SDRAM

Tuner/Reception/Transmission

- Symbol rate: 1-6.9Ms/s

Convenience

- Child Protection: Child Lock
+ Parental Control
- Ease of Installation:
Auto install
- Events timer/reminder: 10
- Radio favorite list: 3
- TV favorite list: 3
- Parental control: Lock with
PIN code, Child timer
- Programmable Events: 1
- Recording: Record failure
alarm, Record header message
- Signal strength indication
- User Interface: Automatic
program list update, Multiple
subtitles supported, Now &
Next ESG, On Screen Display
on TV, TV and Radio mode,
7 day Electronic programme
Guide

Audio Decoding

- Compression format:
MPEG layer I/II

Video Decoding

- Frequency range:
MHz 950-2150, Video bit rate
up to 15 Mbit/s
- Conditional access system:
Nagravision (card not
supplied, Subscription needed
for pay-TV, Irdeto (card not
supplied)
- De-scrambling:
Smart Card reader

Connectivity

- Audio Output - Analog:
Volume controlled L/R cinch,
L/R cinch
- Audio Output - Digital:
AC3 over SPDIF (Optical),
Coaxial (cinch)
- Plug & Play
- TV SCART out: Controlled
audio L/R, CVBS, RGB,
S-Video (for LCD projector)
- VCR SCART in: Audio L/R,
CVBS, RGB

Accessories

- Batteries: 2 x AA
- Included Accessories:
Remote Control,
High quality SCART cable
Mains cord
Antenna Cord type F-IEC
Adapter F male-IEC female
Sticker to be put on your
smart card

Leaflet explaining what to do
with the adapter and sticker
mentioned above
Warranty booklet
User Manual

Dimensions

- Carton dimensions
(W x H x D):
320 x 85 x 295 mm
- Product dimensions
(W x H x D):
238 x 42 x 145 mm
- Temperature (operation):
5° to 40°C
- Temperature (storage):
-20 to 70°C
- Weight: 0.98 kg
- Weight incl. packaging: 1.780 kg

Power

- Power consumption: 10 W
- Power supply: 230 V ~ 50 Hz
- Standby power consumption:
< 7 W

Green Specifications

- Banned Substance
Declaration: Yes, Packaging
Manufacturer: Yes, ODM
- Lead-free soldered product

The product complies
with the following
European Directives:



- 73/23/EEC
- 93/68/EEC
- 89/336/EEC

AC3 and Dolby Digital® are registered trademarks of Dolby Laboratories Licensing Corporation.

Due to continued product improvements, this information is subject to change without notice.



Specifications are subject to change without notice.
Trademarks are the property of Koninklijke Philips Electronics N.V. or their respective owners.
2005 © Koninklijke Philips Electronics N.V. All rights reserved.

www.philips.com

3111 176 52561