

FNID and T200 FNID Fractional T1 Network Interface Device Installation and Maintenance

CONTENTS

1. GENERAL	1
2. INSTALLATION	2
3. CONNECTIONS	3
4. DSL SYSTEM TESTING	4
5. CONTROL PORT OPERATION	4
6. DSL DEPLOYMENT GUIDELINES	11
7. TROUBLESHOOTING PROCEDURES	12
8. MAINTENANCE	12
9. PRODUCT SPECIFICATIONS	12
10. WARRANTY AND CUSTOMER SERVICE	12
Appendix A. FT1 Loopbacks	A-1

FIGURES

Figure 1. ADTRAN FNID	1
Figure 2. FNID Option Switch Locations	2
Figure 3. FNID Network Loop Connection Locations	4
Figure 4. RS-232 (DB9) Pin Assignments	4
Figure 5. Introductory Menu Screen	7
Figure 6. HDSL Main Menu Screen	7
Figure 7. Current System Status Screen	8
Figure 8. Performance History Screen	8
Figure 9. Loopback Options Screen	9
Figure 10. Self Test Options Screen	9
Figure 11. Provisioning Options Screen	10
Figure 12. Troubleshooting Screen	10
Figure 13. DSL Deployment Guidelines	11
Figure A-1. FT1 Loopbacks	A-1
Figure A-2. FT1 DP Network Loopback	A-1
Figure A-3. FT1 DP CPE Loopback	A-1
Figure A-4. FT1 Repeater #1 or # 2 Network Loopback	A-2
Figure A-5. FNID Network Loopback	A-2
Figure A-6. FNID CPE Loopback	A-2

TABLES

Table A. Front Panel Functions	3
Table B. FNID Card Edge Pin Definitions	3
Table C. Definition of Screen Abbreviations	5
Table D. Loop Insertion Loss Data	11
Table E. Troubleshooting Guide	12
Table F. FNID Unit Specifications	13
Table A-1. FT1 Loopback Select Codes	A-3

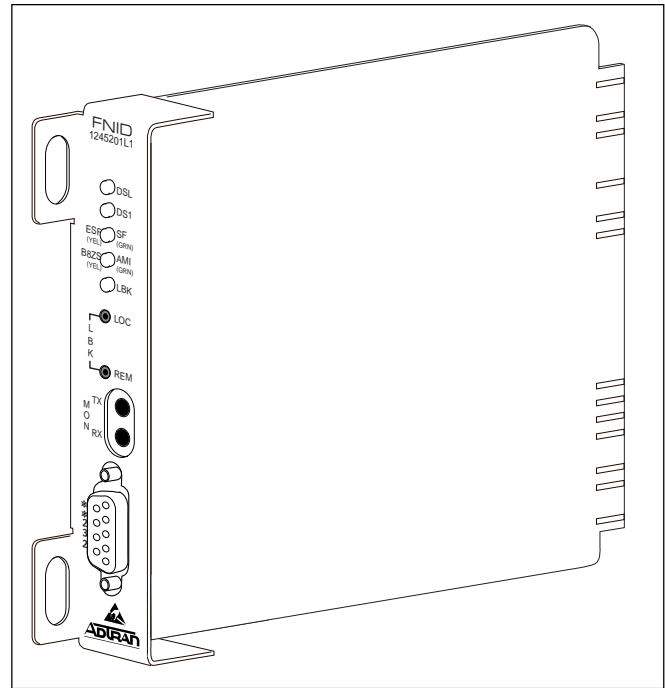

Figure 1. ADTRAN FNID

1. General

This practice is an installation and maintenance (I/M) guide for the ADTRAN Fractional T1 Network Interface Device (FNID). Figure 1 is an illustration of the ADTRAN FNID.

Revision History

This practice has been reissued to reflect additional support detail for two FT1 repeater applications.

The ADTRAN FNID is a network terminating unit used to deploy a fractional T1 circuit using 2-wire metallic facilities on CSA loops. This practice is written to support both the T200 FNID circuit pack (P/N 1245201L1) and the FNID standalone (P/N 4245201L1) units.

The FNID is housed in a standalone metal enclosure. The T200 FNID card plugs into a standard Type 200/400 multiple mounting shelf.

With the exception of the physical dimensions of the units, the FNID and T200 FNID units are functionally identical. The FNID terminates local loop DSL signals originating from the Central Office (CO) unit and transforms the DSL signal into fractional T1 signals to be delivered to the customer.

The DSL local loop operates over a single twisted pair. The FNID communicates over the twisted pair to the FT1 DP (ADTRAN part numbers 1242040L1, 1242046LX, 1242047LX, 1242048LX, 1245205L1, 1245206L1, 1245207L1, 1245208L1) located at the CO. The payload between FT1 DP and FNID is programmable from the faceplate rotary switch as follows:

2 channels (minimum).....	128 kbps
3 channels	192 kbps
4 channels	256 kbps
5 channels	320 kbps
6 channels	384 kbps
7 channels	448 kbps
8 channels	512 kbps
9 channels	576 kbps
10 channels	640 kbps
11 channels	704 kbps
12 channels (maximum)	768 kbps

The system carries a small amount of overhead used for maintenance and performance. The FNID delivers a standard ANSI T1.403 interface to the customer equipment at 1.544 Mbps. The extra bandwidth is nulled out in the form of idle stuffed channels.

2. INSTALLATION



After unpacking the unit, immediately inspect it for possible shipping damage. If damage is discovered, file a claim immediately with the carrier, then contact ADTRAN Customer Service (see subsection 10 of this practice).

FNID Option Selections: Configuration strap P1 selects FNID settings. Figure 2 illustrates P1 location and options.

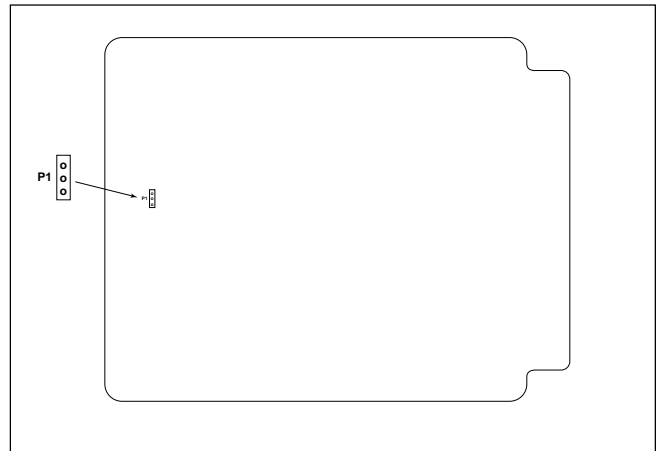

Figure 2. FNID Option Switch Locations

P1 selects DS1 Tx attenuation to the customer. It is selectable between 0dB and -15dB.

Provisioning options (selecting B8ZS/AMI or SF/ESF) are automatically controlled on the FNID when selected at the FT1 DP.

The settings on the FT1 DP are encoded and transmitted to the FNID once the circuit has achieved synchronization.

Front Panel Indicators: There are five status indicators on the front panel. See Table A for a description of these indicators.

Table A. Front Panel Functions

Indicator	Description
DSL	Indicates five possible states of the quality of the DSL signal
Off	No synchronization of FT1 DP and FNID
Red	Poor signal quality ($\geq 10^{-7}$ BER)
Yellow	Marginal signal quality (≤ 2 dB margin above 10^{-7} BER)
Green	Good signal quality (≤ 2 dB margin above 10^{-7} BER)
Blinking	An error detected on the loop will cause this LED to blink briefly
DS1	This LED indicates three possible conditions described below.
Off	The customer-side DS1 signal is absent or in a format that does not match the provisioned options
Blinking	Indicates an error has been detected on the DS1 interface
On Solid	The customer-side DS1 signal is present and synchronized
LBK	This LED indicates two possible loopback states as described below.
Off	Unit is not in loopback
On Solid	Local (FNID) loopback is active
RS-232	DB9 connector for craft interface. Allows connection to controlling terminal. For further information, refer to subsection 6 of this practice.
REM LBK	Remote Loopback. Push button to toggle Loopback active/inactive.
LOL LBK	Local Loopback. Push button to toggle Local Loopback active/inactive.

3. CONNECTIONS

All connections of the FNID are made through card edge connectors. Table B gives the card edge pin assignments for the FNID circuit pack. The circuit pack operates in either the standalone chassis (P/N 1242034L2), the ADTRAN HR4 HDSL shelf (P/N 1242008L1), or the ADTRAN HR12 HDSL shelf (P/N 1242007L1).

When the circuit pack is installed in any of the FNID enclosures, all connections are made through the enclosure backplanes. See the following ADTRAN documents for more information:

- 61242007L1-5, HR12 I/M
- 61242008L1-5, HR4 I/M
- 61242034L2-5, T400 Single Mount I/M (removable RJ-48 jacks)

NOTE: Ensure chassis ground is properly connected for either standalone or shelf-mounted applications.

Table B. FNID Card Edge Pin Definitions

Pin	Designation	Description
1	CH GND	Chassis ground
5	DS1-T1	DS1 Receive Out tip (to Customer Interface)
7	H1-T	DSL Loop Tip (facility)
11	CH GND	Chassis ground
13	H1-R	DSL Loop ring (facility)
15	DS1-R1	DS1 Receive Out ring (to Customer Interface)
17		-48 Return
27	FG	Frame Ground
35		-48 VDC
49	DS1-R	DS1 Transmit In ring (from Customer Interface)
55	DS1-T	DS1 Transmit In tip (from Customer Interface)

4. DSL SYSTEM TESTING

The ADTRAN DSL system provides extensive ability to monitor the status and performance of the DS1 signals and DSL loop signals. The front panel LEDs on the FNID are explained in subsection 2 of this practice. Additional testing features are described in this section. Specifically, the Bantam jacks on the front panel of the FNID are described.

DS1 MON Bantam Jack

The FNID provides a dual Bantam jack on the front panel. This jack, labeled “MON,” provides a non-intrusive access point for monitoring the transmit and receive signals at the DS1 interface point.

NOTE: MON Rx provides access to the DS1 input from the customer’s equipment. MON Tx provides access to the DS1 output of the FNID toward the customer.

FNID Loopbacks

There are two loopbacks available to the FNID. FNID network loopback loops the FT1 signal back toward the network. FNID CPE loopback loops the FT1 signal back toward the customer. FNID network loop connection locations are illustrated in Figure 3. Appendix A contains diagrams and descriptions of the FT1 system loopback capabilities.

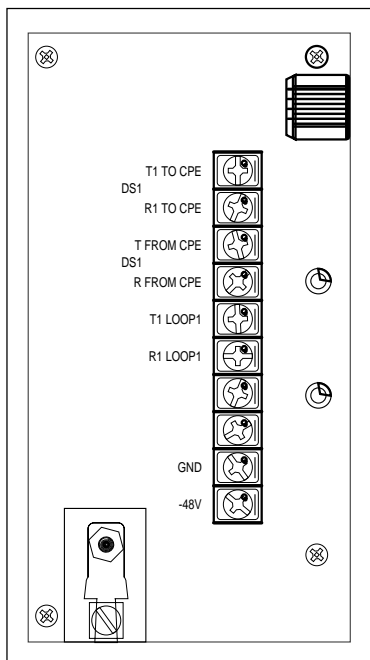

Figure 3. FNID Network Loop Connection Locations

5. CONTROL PORT OPERATION

The FNID provides a faceplate-mounted DB9 connector that supplies an RS-232 interface for connection to a controlling terminal. The pinout of the DB9 is illustrated in Figure 4.

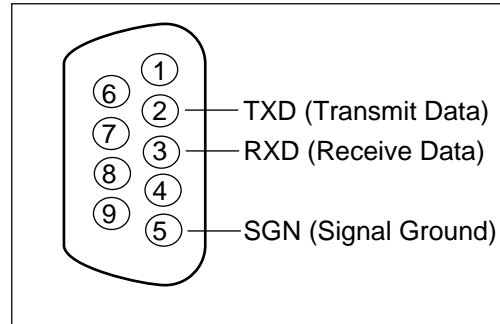

Figure 4. RS-232 (DB9) Pin Assignments

The terminal interface operates at data rates from 2.4 kbps to 19.2 kbps. The asynchronous data format is fixed at 8 data bits, no parity, and 1 stop bit. The supported terminal type is VT-100 or compatible.

NOTE: If you are using a personal computer (PC) with terminal emulation capability, be sure to disable any power saving programs. Otherwise, communication between the PC and the HDSL unit may be disrupted, resulting misplaced characters or screen timeouts.

Operation

A terminal session is initiated by entering multiple space bar characters, which are used by the FNID to determine the speed of the terminal. Once the speed has been determined, an Introductory menu will appear, as illustrated in Figure 5. For abbreviations used in the screen diagrams, refer to Table C.

From the Introductory menu, the Main menu may be selected. The Main menu provides access to detailed performance and configuration information, as illustrated in Figure 6, HDSL Main Menu Screen.

Table C. Definition of Screen Abbreviations

Abbreviation	Definition
ES	Errored seconds DS1 (SF) Second in which a BPV or frame bit error occurs DS1 (ESF) Second in which a BPV or CRC error occurs DSL
SES	Severely errored seconds DS1 (SF) Second in which 1554 BPVs or 8 frame bit errors occur DS1 (ESF) Second in which 1544 BPVs or 320 CRC errors occur DSL
UAS	Unavailable seconds DS1 Second in which there is a loss of signal or sync DSL
SF	Superframe format
ESF	Extended superframe format
B8ZS	Binary 8-zero substitution
AMI	Alternate mark inversion
LBO	Line build-out
BPV	Bipolar violation DS1 Second in which a bipolar violation occurs
NIU	T1 network interface unit
S/N	Serial number
15M	Fifteen-minute period
24H	Twenty-four-hour period

From the Main menu the following screens can be accessed.

1. Current System Status
2. Performance History
3. ADTRAN Information
4. Loopback Options
5. Self Test
6. Provisioning
7. Troubleshooting

The Current System Status screen, illustrated in Figure 7, provides quick access to status information for both the FT1-DP and FNID. The Elapsed Time display indicates the period of time since the unit began collecting performance information.

Current information for the DSL and DS1 interfaces is consolidated on this screen. A key to the information provided is found in the center of the screen. Arrows indicate the key applies to both the FT1 DP and FNID.

- LOSS Pulse Attenuation Measurement
- SYNC HDSL Loop 1 Sync Status
- ES 15M/24H Errored Seconds
- SES 15M/24H Severely Errored Seconds
- UAS 15M/24H Unavailable Seconds

For example: ES 012/264 indicates that 12 errored seconds have occurred in the current 15-minute period while a total of 264 errored seconds have occurred in the last 24 hours.

A measure of signal quality for each HDSL loop is displayed in graphic form on the bottom right and left of the screen. The measure is from 0 (poor signal quality) to 9 (excellent signal quality). Guidelines for interpreting the indicators are:

- 0 Noise margin is ≤ 0 dB ($\approx 10^{-7}$ BER)
- 1-8 Margin measurement above 10^{-7} BER in dB
- 9 Margin is ≥ 9 dB (excellent quality) above 10^{-7} BER

Predicting performance based upon signal quality varies with each loop. Generally, a noise margin of 0 or higher will support a bit error rate of better than 10^{-7} .

The Performance History screen is illustrated in Figure 8. At each 15-minute interval, the performance information is transferred to the 15-minute performance data registers accessed from the Performance History screen. At each 24-hour interval, the performance data is transferred into the 24-hour performance data register also accessed using this screen.

At the Current System Status screen, type “Z” in order to reset performance registers to zero at both the Current System Status and Performance History screens.

Figure 9 depicts the FT1 Loopback Options screen while Figure 10 depicts the Self-Test Options screen. Loopbacks and Self-Test may be evoked or terminated using these screens. A status of current loopback conditions is also provided.

Figure 11 shows the Provisioning Options screen. Provisioning may only be viewed from the FNID at all times. Provisioning is controlled from the FT1 DP.

The Troubleshooting Display, shown in Figure 12, graphically presents an FT1 circuit. The unit reviews red, yellow, and blue alarm conditions in the circuit to automatically predict where a fault is located. Once a fault location is suspected, the corresponding portion of the circuit on the screen is highlighted and a message describing the failure will appear.

ADTRAN
901 Explorer Boulevard
Huntsville, Alabama 35806-2807

For Information or Technical Support,

Normal Support Hours (7am - 7pm CST) or Emergency Support Hours (7x24)
Voice Toll Free: 800.726.8663 Fax: 256.963.6217
Voice: 256.963.8100 Internet: www.adtran.com

FT1-DP INFORMATION	SIGNAL QUALITY	FNID INFORMATION	SIGNAL QUALITY
-----	[] 9	-----	[] 9
S/N :	[] 8	S/N : DATA NOT AVAIL	[] 8
CLEI:	[] 7	CLEI:	[] 7
MANF: /	[] 6	MANF:	[] 6
	[] 5		[] 5
	[] 4		[] 4
	[] 3		[] 3
	[] 2		[] 2
	[] 1		[] 1
	[] 0		[] 0
	AT FT1-DP		AT FNID

Press "M" to view Main Menu.

Figure 5. Introductory Menu Screen

ADTRAN FT1 MAIN MENU

- 1) CURRENT SYSTEM STATUS
- 2) PERFORMANCE HISTORY
- 3) ADTRAN INFORMATION
- 4) LOOPBACK OPTIONS
- 5) SELF-TEST
- 6) PROVISIONING
- 7) TROUBLESHOOTING

Choose a screen by pressing the corresponding number.

Figure 6. HDSL Main Menu Screen

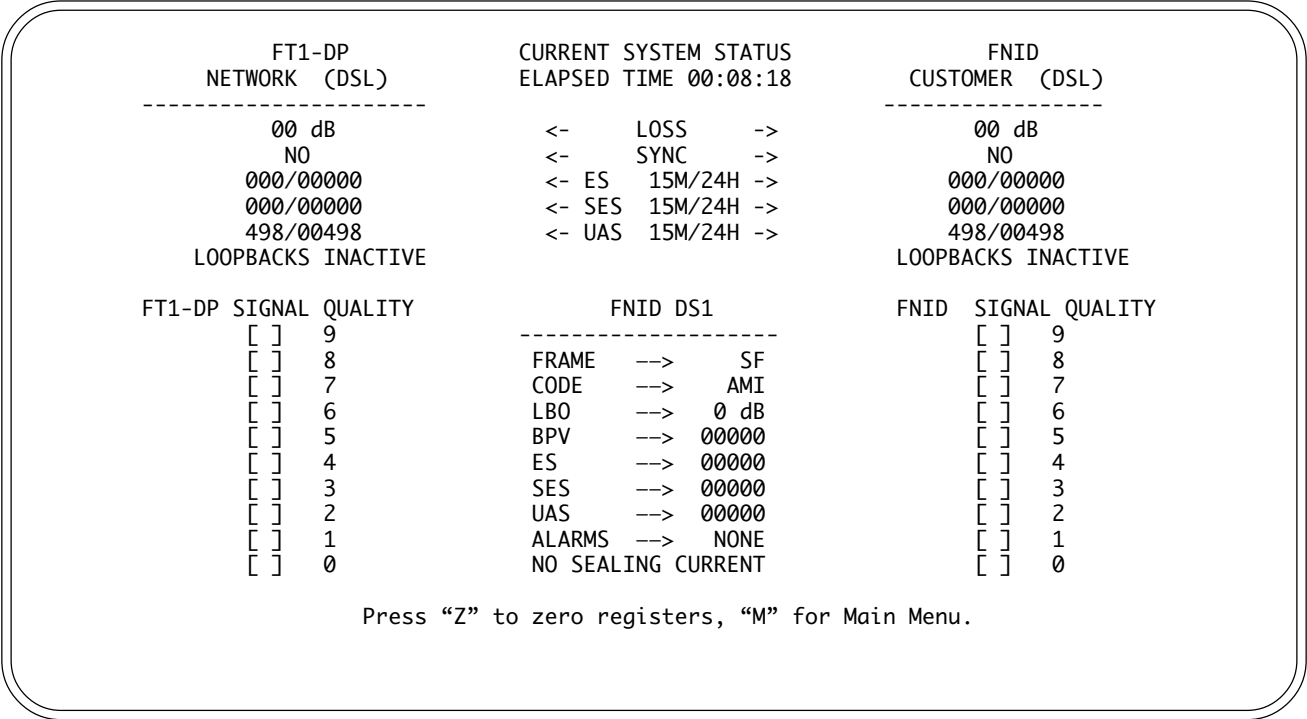

Figure 7. Current System Status Screen

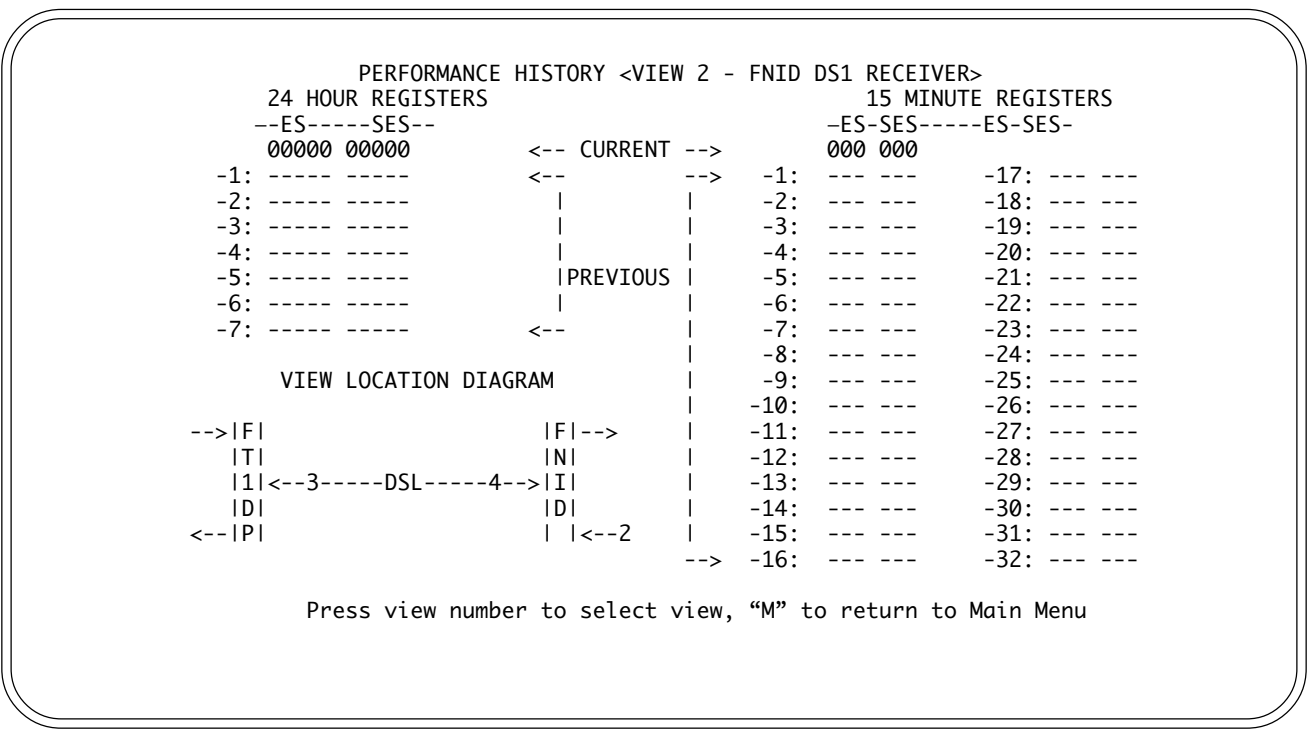

Figure 8. Performance History Screen

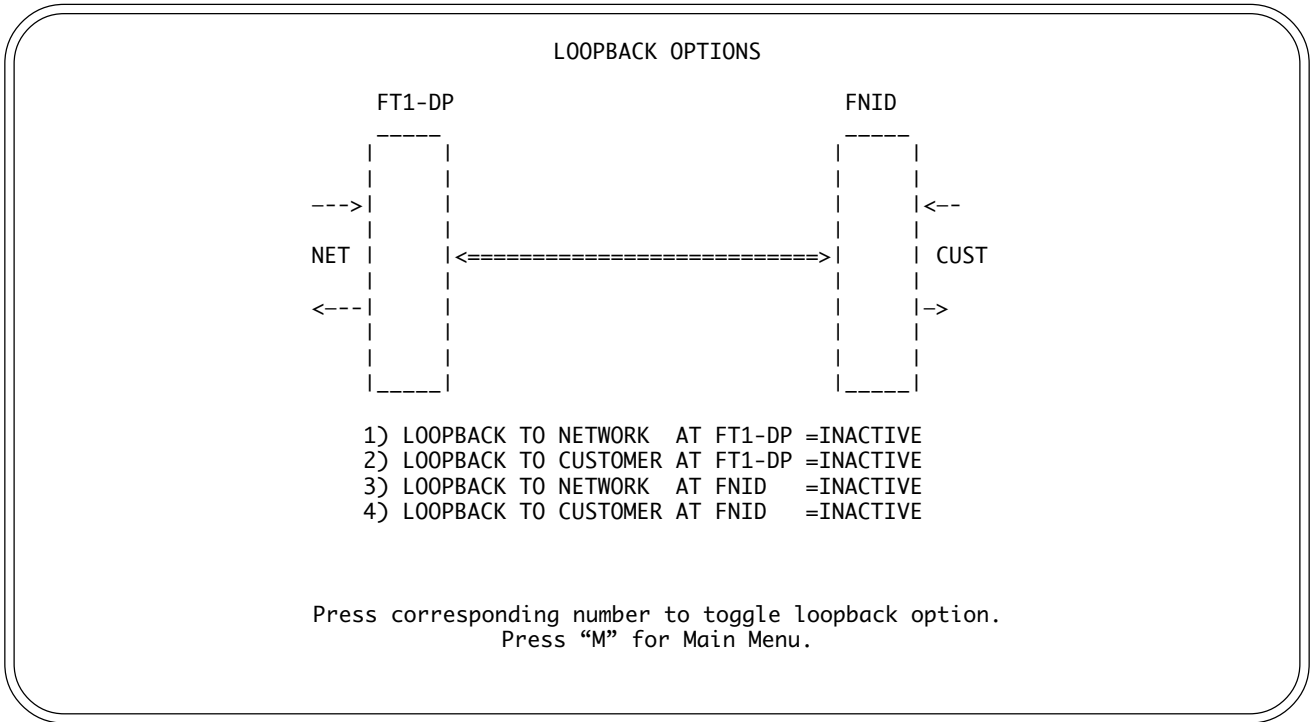

Figure 9. Loopback Options Screen

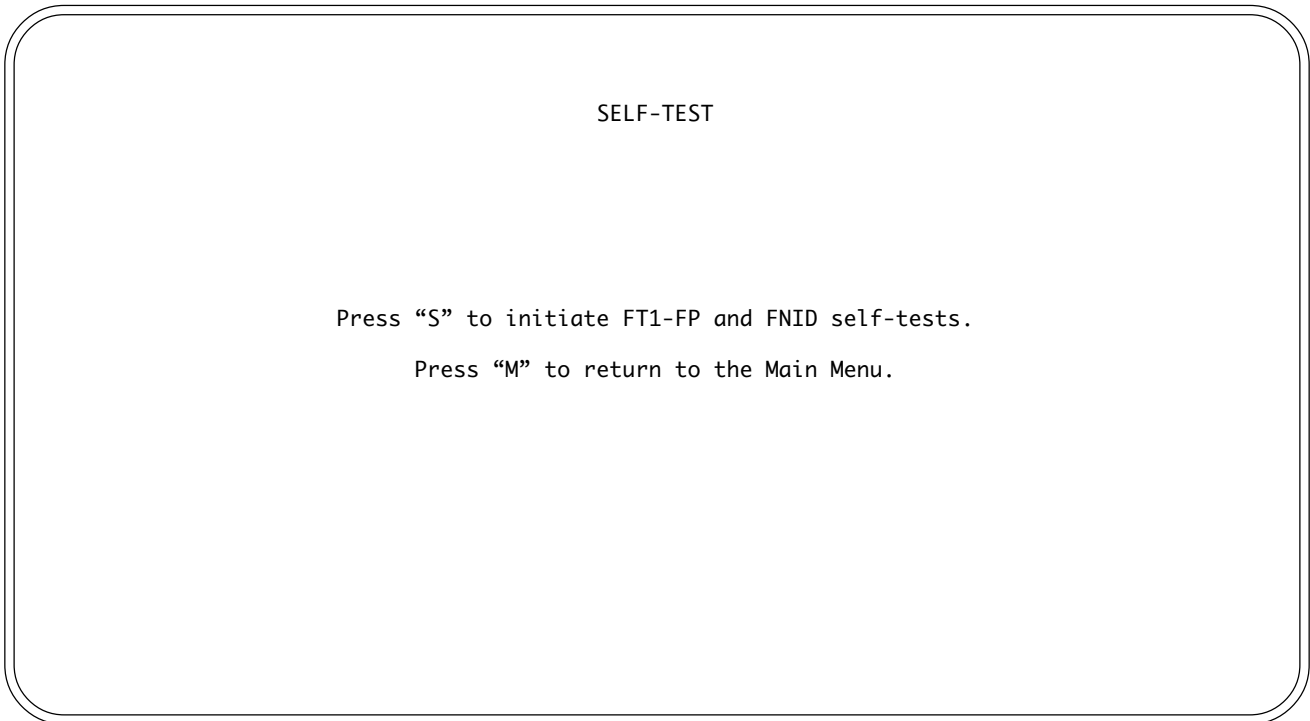

Figure 10. Self-Test Options Screen

PROVISIONING

PROVISIONS	CURRENT SETTINGS	HARDWARE SETTINGS
1. DS1 (FNID) LINE CODE	= B8ZS	B8ZS
2. DS1 (FNID) FRAMING	= ESF	ESF
3. DS1 (FNID) TX LEVEL	= 0 dB	
4. LOOPBACK TIMEOUT	= 20 MIN	20 MIN
5. LATCHING LOOPBACK	= ENABLED	ENABLED
6. DSO SEQUENCE	= ALTERNATING	ALTERNATING
7. NUMBER OF DSOS	= 12 (768Kbps)	12 (768Kbps)

Press: "n" - to change corresponding provision (ex. "2" for FRAMING)
"H" - to copy hardware settings to current settings
"I" - to implement and save current setting changes
"M" - to return to the main menu

Figure 11. Provisioning Options Screen

TROUBLESHOOTING DISPLAY

FT1-DP

NET

FNID

CUST

←-----→

ALARMS:

FT1-DP RED

FT1-DP RED

PROBLEM INDICATED:

CHANNEL BANK ALARM

DSL LOSS

Press "M" for Main Menu.

Figure 12. Troubleshooting Screen

6. DSL DEPLOYMENT GUIDELINES

The ADTRAN FT1 DSL system is designed to provide Fractional DSL-based services over loops designed to comply with Carrier Service Area (CSA) guidelines. CSA deployment guidelines are given below.

1. All loops are non-loaded only.
2. For loops with 26-AWG cable, the maximum loop length including bridged tap lengths is 9 kft.
3. For loops with 24-AWG cable, the maximum loop length including bridged tap lengths is 12 kft.
4. Any single bridged tap is limited to 2 kft.
5. Total bridged tap length is limited to 2.5 kft.
6. The total length of multi-gauge cable containing 26-AWG cable must not exceed $12 - \{(3 * L^{26}) / 9\} - L^{BTAP}$ (in kft)

L^{26} = Total length of 26-AWG cable excluding bridged taps (in kft)

L^{BTAP} = Total length of all bridged taps (in kft)

This deployment criteria is summarized in the chart shown in Figure 13.

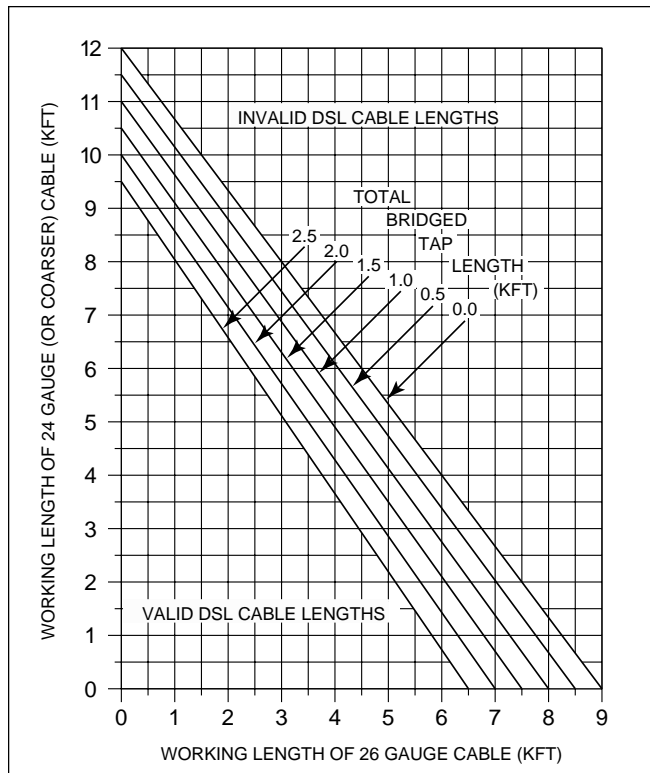

Figure 13. DSL Deployment Guidelines

Recommended maximum local loop loss information for PIC cable at 70°F, 135Ω, resistive termination is provided in Table D.

Table D. Loop Insertion Loss Data

Frequency (Hz)	Maximum Loss (dB)
3,000	12.0
10,000	15.0
50,000	25.5
100,000	30.0
150,000	32.75
200,000	35.25

An approximation for the maximum amount of wideband noise on a DSL local loop as measured by a 50 kbps filter is ≤ 31 dBm.

An approximation for the maximum level of impulse noise as measured using a 50 kbps filter on an DSL loop is ≤ 50 dBm.

These approximations are to be used as guidelines only and may vary slightly on different loops. Adhering to the guidelines should produce performance in excess of 10^{-7} BER.

7. TROUBLESHOOTING PROCEDURES

Table E is a troubleshooting guide for the FNID.

8. MAINTENANCE

The ADTRAN FNID requires no routine maintenance. In case of equipment malfunction, use the faceplate Bantam jack connectors to help locate the source of the problem.

ADTRAN does not recommend that repairs be performed in the field. Repair services may be obtained by returning the defective unit to the ADTRAN Customer Service RMA Department.

9. PRODUCT SPECIFICATIONS

Specifications for the FNID are provided in Table F.

10. WARRANTY AND CUSTOMER SERVICE

ADTRAN will replace or repair this product within five years from the date of shipment, if the product does not meet its published specifications or if it fails while in service. For detailed warranty, repair, and return information, refer to the ADTRAN Telco Network Equipment Warranty and Return Policy and Procedure, document 6000008-10A.

Return Material Authorization (RMA) is required prior to returning equipment to ADTRAN. ADTRAN does not recommend that repairs be performed in the field.

For service, RMA requests, or further information, contact one of the following numbers:

ADTRAN Customer Service:

ADTRAN Telco Technical Support. (800) 726-8663

Standard support hours Monday-Friday
7 a.m. - 7 p.m. CST

Emergency support 7 days/week, 24 hours/day

Sales (800) 827-0807

RMA (repair service) (256) 963-8722

Repair and Return Address:

ADTRAN, Inc.
Customer and Product Support (CAPS) Department
901 Explorer Boulevard
Huntsville, Alabama 35806-2807

Table E. Troubleshooting Guide

Condition	Solution
All front panel indicators are <i>off</i> .	<ol style="list-style-type: none"> 1. Verify that the FNID is properly seated in the housing. 2. Make sure power supply feed the FNID is in good working condition. 3. If Steps 1 and 2 pass, replace the FNID.
Power is OK, but does not achieve loop sync (DSL LED is <i>off</i> .)	<ol style="list-style-type: none"> 1. Verify that the loop conforms with CSA guidelines (not too long, etc.). 2. Verify that the loop loss at 200 kHz is not greater than 36 dB. 3. Verify that noise on the DSL loop is within acceptable limits. 4. If Steps 1 through 4 pass and loop sync is still not available, replace the FNID.

Table F. FNID Unit Specifications

Loop Interface:

Modulation Type 2B1Q
Mode Full Duplex, Echo Cancelling
Number of Pairs One
Bit Rate 784 kbps
Baud Rate 392K baud
Service Range Defined by Carrier Service Area Guidelines
Loop Loss 36 dB maximum @ 200 kHz
Bridged Taps Single Taps < 2 kft, Total Taps < 2.5 kft
Performance Compliant with Bellcore TA-NWT-001210
Return Loss 20 dB (40 kHz to 200 kHz)
DSL Tx Signal Level 13.5 dBm
Input Impedance 135 Ω
DS1 Channelization Channels 1-12

Customer Interface:

4-wire DS1 (T1.403-compatible)
DS1 Signal Output Level Programmable through FT1 DP at 0, or -15 dB
DS1 Input Signal Level 0, or -15 dB
DS1 Line Coding AMI, B8ZS
DS1 Framing Format SF, ESF

Power:

Span Power Selectable: less than -140 VDC (Class A2 with GFI circuit), or less than -190 VDC
(Class A2 with GFI circuit)
Locally Powered -48 V at 75 mA

Clock Sources:

Clock Sources Internal, DSL Loop Derived
Internal Clock Accuracy ±25 ppm, (exceeds Stratum 4). Meets T1.101 timing requirements.

Tests:

Diagnostics Loopback (FNID), initiated with DDS latching loopbacks, initiated with FT1 DP command. Self-Test.

Physical:

Dimensions 2.25" High, 8.75" Wide, 10.25" Deep
Weight 4 pounds (standalone)

Environment:

Temperature Operating (Standard): -40° to +70°C; Storage: -40° to +85°C

Part Numbers:

Circuit Pack 1245201L1

Appendix A

FT1 Loopbacks

1. GENERAL

This Appendix is an overall reference to the loopback capabilities of the ADTRAN Fractional T1 system. Included in this Appendix is a description of the FT1 loopbacks and the methods for activating the FT1 loopbacks.

2. FT1 LOOPBACKS

Figure A-1 shows the application from the central office (CO) to customer premises. The FT1 Repeaters are shown for convenience and are not necessary parts of the FT1 network. The loopbacks shown are as follows:

- A. FT1 DP network loopback
- B. FT1 DP CPE loopback
- C. FT1 Repeater # 1 network loopback
- D. FT1 Repeater # 2 network loopback
- E. FNID network loopback
- F. FNID CPE loopback

There are two loopbacks available to the FT1 DP. The FT1 DP network loopback loops the FT1 signal

back to the network. The FT1 DP CPE loopback loops the FT1 signal back to the customer.

The FT1 DP network loopback is a digital loopback toward the CO (see Figure A-2). This loopback is initiated by the OCU latching loopback command (N1010101), or by the craft interface, when available. The OCU latching loopback code is detected in the primary DS0 of the FT1 circuit (the channel where the FT1 DP is physically installed) to control the FT1 circuit looping. When the FT1 circuit is looped, all DS0s in use will be looped back toward the network. The DS0s will be transmitted on to the customer.

The FT1 DP CPE loopback is a digital loopback toward customer premises as shown in Figure A-3. This loopback is initiated by the REM LBK button on the FNID, or by the craft interface when available. When the FT1 circuit is looped, all DS0s in use will be looped back toward the customer. All DS0s in use will be filled with all 1s and sent toward the network.

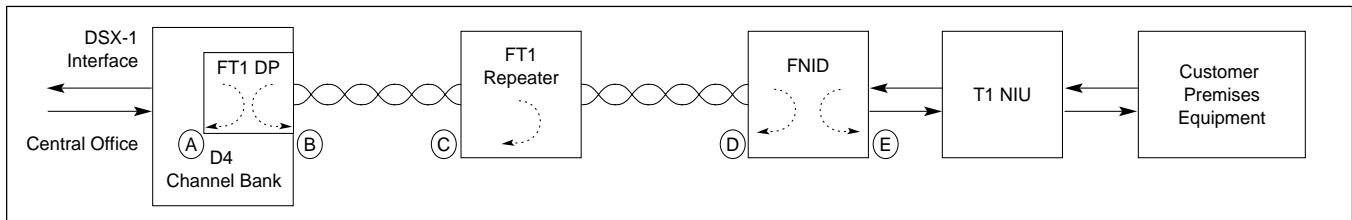

Figure A-1. FT1 Loopbacks

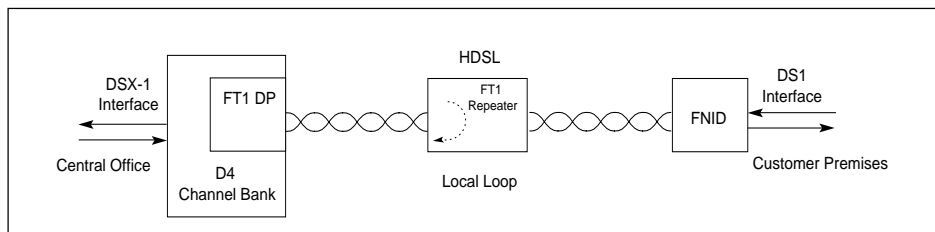

Figure A-2. FT1 DP Network Loopback

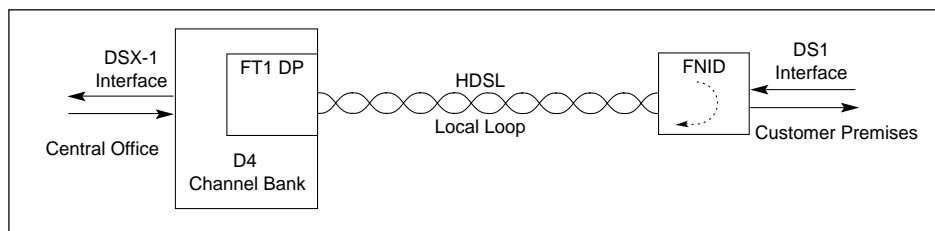

Figure A-3. FT1 DP CPE Loopback

There is one loopback available to the FT1 Repeaters. The FT1 Repeater Network loopback is a digital loopback toward the CO as shown in Figure A-4. The loopbacks are initiated by the DDS latching loopback codes for NEI Position 1 (N1000001) for FT1 #1 or NEI Position 2 (N100001) for FT1 Repeater # 2. The NEI latching loopback is detected in the primary DS0 of the FT1 circuit, the channel where the FT1 DP is physically installed, to control the looping of the FT1 circuit. When the FT1 circuit is looped, all DS0s in use will be looped. The DS0s in use will also be transmitted on to the customer.

There are two loopbacks available to the FNID. The FNID network loopback loops the FT1 signal back toward the network. The FNID CPE loopback loops the FT1 signal back toward the customer.

The FNID network loopback is a digital loopback toward the CO as illustrated in Figure A-5. This

loopback is initiated by the DDS latching loopback code for NEI Position 1 (N1000001) for a non-repeated loop, or NEI Position 2 (N1000001) for a single repeater loop or by NEI Position 3 (N1000001) for a two repeater loop; by the craft interface when available, or by the REM LBK button at the FT1 DP. The NEI Position 1 latching loopback is detected in the primary DS0 of the FT1 circuit (the channel in which the FT1 DP is physically installed), to control the looping of the FT1 circuit. When the FT1 circuit is looped, all DS0s in use will be looped. The DS0s in use will be filled with all 1s and transmitted toward the customer.

The FNID CPE loopback is a digital loopback toward customer premises as shown in Figure A-6. This loopback is initiated by the craft interface, when available. When the FT1 circuit is looped, all DS0s in use will be looped. The data in the DS0s in use will be transmitted toward the network.

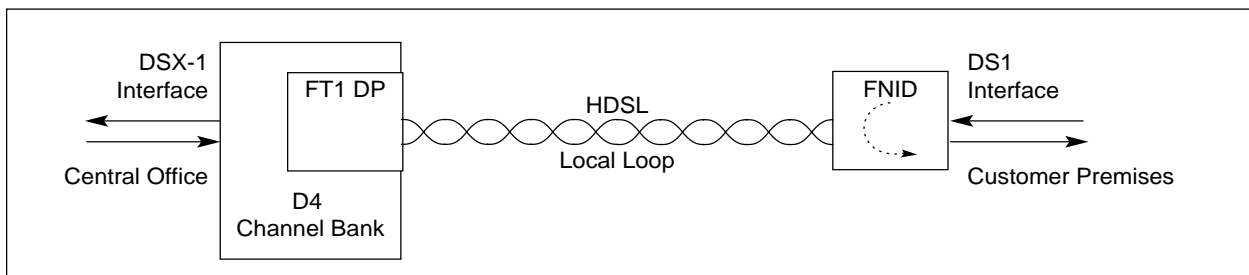

Figure A-4. FT1 Repeater # 1 or 2 Network Loopback

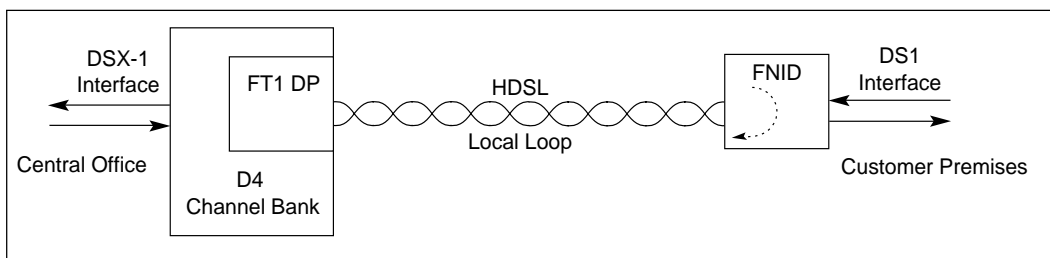

Figure A-5. FNID Network Loopback

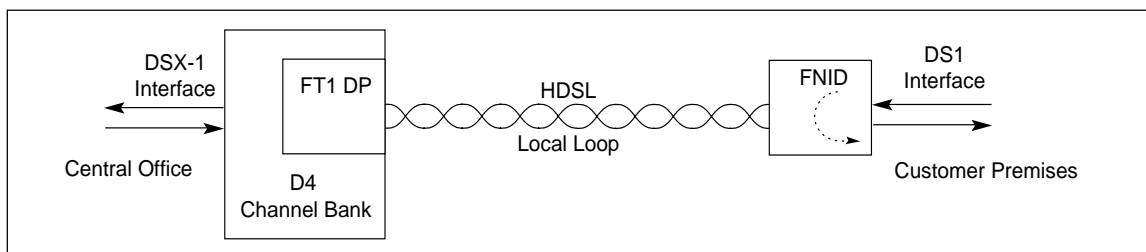

Figure A-6. FNID CPE Loopback

3. LOOPBACK ACTIVATION/DEACTIVATION

This section describes loopback activation and deactivation methods for the ADTRAN Fractional T1 system. Loopback activation and deactivation is controlled with the push-button located on the front panel, through craft interface, or latching loopback codes.

Both the FNID and the FT1 DP have a push-button located on the front panel labeled REM LBK or RLB which controls the activation of remote loopback. Pressing REM LBK or RLB on the FNID activates FT1 DP CPE loopback. Pressing REM LBK or RLB on the FT1 DP activates FNID network loopback or repeater loopback when a repeater is present. Remote loopback is deactivated by pressing the REM LBK or RLB or waiting for the 20-minute loopback timeout, if enabled.

The FNID and FT1 DP (when available) have a craft interface located on the front panel of the device. The craft interface allows access to the FT1 device through an RS-232-type interface. All loopbacks for the FNID and FT1 DP can be controlled from the craft interface. The craft interface on the FNID can activate and deactivate the FNID network loopback and the FNID CPE loopback. The FNID craft interface can also remotely activate and deactivate the FT1 DP network loopback, FT1 DP CPE loopback, and the repeater network loopback. The craft interface on the FT1 DP can activate and deactivate the FT1 DP network loopback and the FT1 DP CPE loopback. The FT1 DP craft interface can also remotely activate and deactivate the FNID network loopback and the FNID CPE loopback and the repeater network loopback.

FT1 DP, FT1 Repeater, and FNID network loopbacks can be activated by the DDS latching loopback sequence. The latching loopback sequence is detected in the primary DS0 of the FT1 system. When the loopback is activated on the device, the whole FT1 bandwidth is looped. The FT1 DP, FT1 Repeater, and FNID each respond to a different loopback select code allowing for sectionalization of the network during testing. Table A-1 is a list of FT1 devices and their loopback select codes.

Latching loopbacks for the FT1 system are activated by transmitting the following latching loopback sequence in the primary DS0 of the FT1 system:

- A. Minimum of 35 transition in progress (TIP) bytes (N0111010).
- B. Minimum of 35 loopback select code (LSC) bytes as defined in Table I.
- C. Minimum of 100 loopback enable (LBE) bytes (N1010110).
- D. Minimum of 35 all 1s bytes (S1111111), plus a minimum of 100 LBE bytes. (N-1) iterations, where N is the number of channel units of the same type (i.e., same LSC) that lie between the test center and the loopback to be operated. This step is only used when there are identical channel units in tandem.
- E. Minimum of 32 far end voice (FEV) bytes (N1011010).

A 25-second watchdog timer is activated between the 35 TIP bytes and 35 LSC bytes, between the 35 LSC bytes and 100 LBE bytes, and between the 100 LBE bytes and 32 FEV bytes. The timer requires the correct receipt of the latter sequences less than 25 seconds after receipt of the prior sequence. This prevents inadvertent setting of the latching loopbacks.

Latching loopbacks for the FT1 system are deactivated by transmitting the following latching loopback sequence in the primary DS0 of the FT1 system:

Minimum of 35 TIP bytes (N0111010).

4. LOOPUP STATE

In the loopup state, the active FT1 loopback will provide a continuous loop for the FT1 bandwidth. The data flow is continuously monitored for the loop deactivation commands to deactivate the loopbacks. Also, a 20-minute loopback timeout is checked. If the loopback timeout is enabled, any loopback that is in the loopup state for 20 minutes will be deactivated.

Table A-1. FT1 Loopback Select Codes

FT1 Device	Loopback Select Code Name	Loopback Select Code Byte
FT1 DP	OCU loopback	N1010101
FT1 Repeater #1	NEI Position 1 loopback	N1000001
FT1 Repeater #2	NEI Position 2 loopback	N1000001
FNID without repeater	NEI Position 1 loopback	N1000001
FNID with one repeater	NEI Position 2 loopback	N1000001
FNID with two repeaters	NEI Position 3 loopback	N1000001