

Mini Hi-Fi System

FWM352

User manual
Manuel d'utilisation
Manual del usuario
Benutzerhandbücher
Gebruikershandleidingen
Manuale per l'utente
Användarhandböckerna
Brugermanual
Käyttöoppaita
Manual do usuário
εγχειρίδιο χρήσης



PHILIPS

Important notes for users in the U.K.

Mains plug

This apparatus is fitted with an approved 13 Amp plug. To change a fuse in this type of plug proceed as follows:

- 1 Remove fuse cover and fuse.
- 2 Fix new fuse which should be a BS1362 3 Amp, A.S.T.A. or BSI approved type.
- 3 Refit the fuse cover:

If the fitted plug is not suitable for your socket outlets, it should be cut off and an appropriate plug fitted in its place.

If the mains plug contains a fuse, this should have a value of 3 Amp. If a plug without a fuse is used, the fuse at the distribution board should not be greater than 3 Amp.

Note: The severed plug must be disposed of to avoid a possible shock hazard should it be inserted into a 13 Amp socket elsewhere.

How to connect a plug

The wires in the mains lead are coloured with the following code: blue = neutral (N), brown = live (L).

- As these colours may not correspond with the colour markings identifying the terminals in your plug, proceed as follows:
 - Connect the blue wire to the terminal marked N or coloured black.
 - Connect the brown wire to the terminal marked L or coloured red.
 - Do not connect either wire to the earth terminal in the plug, marked E (or ⏏) or coloured green (or green and yellow).

Before replacing the plug cover, make certain that the cord grip is clamped over the sheath of the lead - not simply over the two wires.

Copyright in the U.K.

Recording and playback of material may require consent. See Copyright Act 1956 and The Performer's Protection Acts 1958 to 1972.

Italia

DICHIARAZIONE DI CONFORMITA'

Si dichiara che l'apparecchio FWM352 Philips risponde alle prescrizioni dell'art. 2 comma 1 del D.M. 28 Agosto 1995 n. 548.

Fatto a Eindhoven

Philips Consumer Electronics
Philips, Glaslaan 2
5616 JB Eindhoven, The Netherlands

Norge

Typeskilt finnes på apparatens underside.

Observer: Nettbryteren er sekundert innkoplet. Den innebygde nettdelen er derfor ikke frakoplet nettet så lenge apparatet er tilsluttet nettkontakten.

For å redusere faren for brann eller elektrisk støt, skal apparatet ikke utsettes for regn eller fuktighet.

CAUTION

Visible and invisible laser radiation. If the cover is open, do not look at the beam.

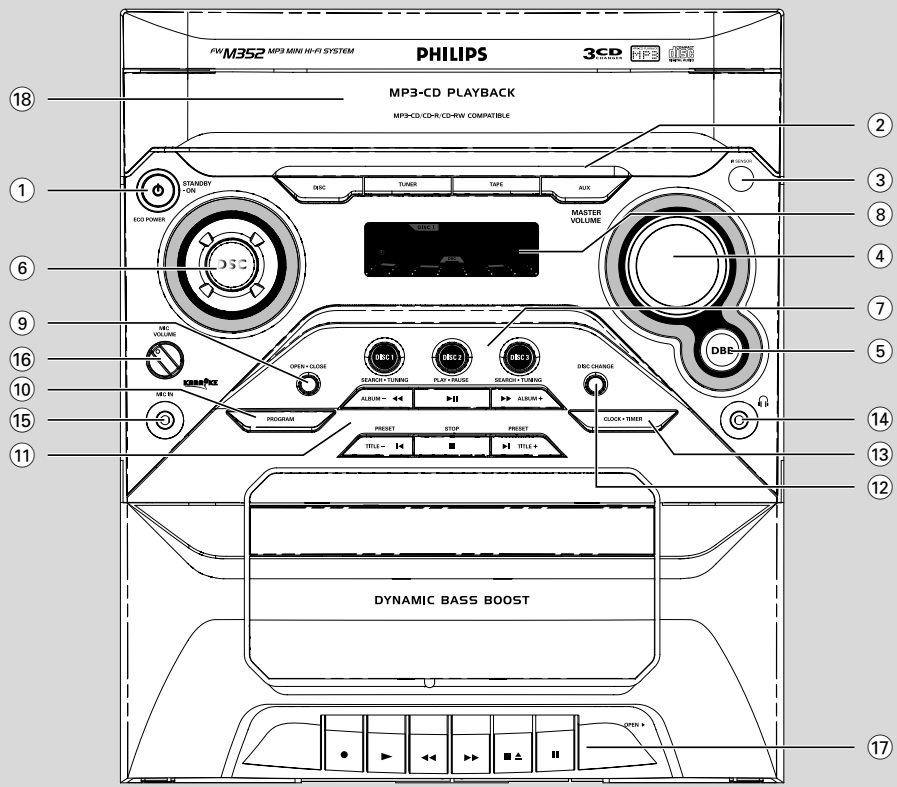
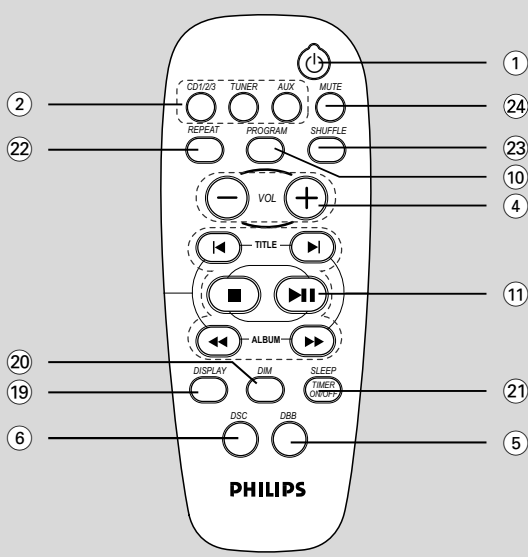

DK

Advarsel: Usynlig laserstråling ved åbning når sikkerhedsafbrydere er ude af funktion. Undgå udsættelse for stråling.

Bemærk: Netafbryderen er sekundært indkoblet og afbryder ikke strømmen fra nettet. Den indbyggede netdel er derfor tilsluttet til lysnettet så længe netstikket sidder i stikkontakten.

S

Klass 1 laserparat

Varning! Om apparaten används på annat sätt än i denna bruksanvisning specificerats, kan användaren utsättas för osynlig laserstrålning, som överskrider gränsen för laserklass 1.

Observera! Stömbrytaren är sekundärt kopplad och bryter inte strömmen från nätet. Den inbyggda nätdelen är därför ansluten till elnätet så länge stickproppen sitter i vägguttaget.

SF

Luokan 1 laserlaite

Varoitus! Laitteen käyttäminen muulla kuin tässä käyttöohjeessa mainitulla tavalla saattaa altistaa käyttäjän turvallisuusluokan 1 ylittävälle näkymättömälle lasersäteilylle.

Oikeus muutoksiin varataan. Laite ei saa olla alttiina tippu- ja roiskevedelle.

Huom. Toiminnanvalitsin on kytketty toisipuolelle, eikä se kytke laitetta irti sähköverkosta. Sisäänrakennettu verkko-osa on kytkettyinä sähköverkkoon aina silloin, kun pistoke on pistorasiasassa.

DEMO MODE

To turn ON

Press & HOLD



button

for 5 seconds

To turn OFF

Press & HOLD



button

for 5 seconds

PLUG & PLAY

(for tuner installation)

1



Plug in the unit

2



Follow instructions
in the display

3



Press "PLAY"

English 6

Français 28

Español 50

Deutsch 72

Nederlands 94

Italiano 116

Svenska 138

Dansk 160

Suomi 182

Português 204

Ελληνικά 226

English

Français

Español

Deutsch

Nederlands

Italiano

Svenska

Dansk

Suomi

Português

Ελληνικά

Contents

General Information

Supplied accessories	7
Acknowledgement	7
Environmental information	7
Safety information	7

Preparations

Rear connections	8–9
Power	
Antennas connection	
Speakers connection	
Optional connection	9
Connecting other equipment to your system	
Inserting batteries into the remote control	9

Controls

Controls on the system and remote control	10–11
---	-------

Basic Functions

Plug and Play	12
Demonstration mode	13
Switching the system to Eco Power standby mode	13
Power-saving automatic standby	13
Dim mode	13
Volume control	13
Sound control	14
DSC (Digital Sound Control)	
DBB (Dynamic Bass Boost)	
Karaoke	14

CD/MP3-CD Operations

Discs for playback	15
About MP3 disc	15
Loading discs	15
Playing discs	16
Replacing discs during playback	16
Selecting a desired track/passage	16
Selecting a desired Album/Title (MP3 disc only)	16
Different play modes: SHUFFLE and REPEAT	17
Programming the disc tracks	17
Erasing the programme	17

Radio Reception

Tuning to radio stations	18
Storing preset radio stations	18–19
Automatic preset programming	
Manual preset programming	
Tuning to preset radio stations	19

Tape Operation/Recording

Playing tapes	20
General information on recording	21
Synchro start CD recording	21
Recording from the radio	21
Maintenance	22

External Sources

Listening to external sources	22
-------------------------------------	----

Clock/Timer

View clock	23
Clock setting	23
Timer setting	23
To deactivate the TIMER	
To activate the TIMER	
Sleep timer setting	24

Specifications

Troubleshooting

This product complies with the radio interference requirements of the European Community.

Supplied accessories

- 2 speaker boxes
- remote control
- MW loop antenna
- FM wire antenna

Acknowledgement

Energy Star

As an ENERGY STAR® Partner, Philips has determined that this product meets the ENERGY STAR® guidelines for energy efficiency.



Environmental information

All unnecessary packaging has been omitted. We have tried to make the packaging easy to separate into three materials: cardboard (box), polystyrene foam (buffer) and polyethylene (bags, protective foam sheet).

Your system consists of materials which can be recycled and reused if disassembled by a specialised company. Please observe the local regulations regarding the disposal of packaging materials, exhausted batteries and old equipment.

Disposal of your old product

Your product is designed and manufactured with high quality materials and components, which can be recycled and reused.



When this crossed-out wheeled bin symbol is attached to a product it means the product is covered by the European Directive 2002/96/EC. Please inform yourself about the local separate collection system for electrical and electronic products.

Please act according to your local rules and do not dispose of your old products with your normal household waste. The correct disposal of your old product will help prevent potential negative consequences for the environment and human health.

Safety information

- Before operating the system, check that the operating voltage indicated on the typeplate (or the voltage indication beside the voltage selector) of your system is identical with the voltage of your local power supply. If not, please consult your dealer.
- Place the system on a flat, hard and stable surface.
- Place the system in a location with adequate ventilation to prevent internal heat build-up in your system. Allow at least 10 cm (4 inches) clearance from the rear and the top of the unit and 5 cm (2 inches) from each side.
- The ventilation should not be impeded by covering the ventilation openings with items, such as newspapers, table-cloths, curtains, etc.
- Do not expose the system, batteries or discs to excessive moisture, rain, sand or heat sources caused by heating equipment or direct sunlight.
- No naked flame sources, such as lighted candles, should be placed on the apparatus.
- No objects filled with liquids, such as vases, shall be placed on the apparatus.
- Don't expose the system to dripping or splashing.
- Install this unit near the AC outlet and where the AC power plug can be reached easily.
- The lens may cloud over when the system is suddenly moved from cold to warm surroundings, making it impossible to play a disc. Leave the system in the warm environment until the moisture evaporates.
- The mechanical parts of the set contain self-lubricating bearings and must not be oiled or lubricated.
- **When the system is switched to Standby mode, it is still consuming some power. To disconnect the system from the power supply completely, remove the AC power plug from the wall socket.**

Preparations

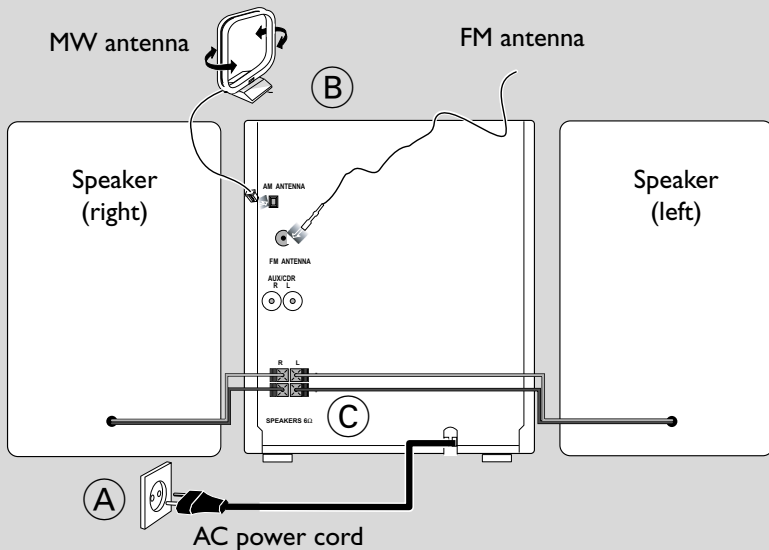

Rear connections

The type plate is located at the rear of the system.

For users in the U.K.: please follow the instructions on page 2.

A Power

Before connecting the AC power cord to the wall outlet, ensure that all other connections have been made.

WARNING!

- For optimal performance, use only the original power cable.
- Never make or change any connections with the power switched on.
- High voltage! Do not open. You run the risk of getting an electric shock.
- The machine does not contain any user-serviceable parts.
- Modification of the product could result in hazardous radiation of EMC or other unsafe operation.

To avoid overheating of the system, a safety circuit has been built in. Therefore, your system may switch to Standby mode automatically under extreme conditions. If

this happens, let the system cool down before reusing it (not available for all versions).

B Antennas Connection

Connect the supplied MW loop antenna and FM antenna to the respective terminals. Adjust the position of the antenna for optimal reception.

MW Antenna

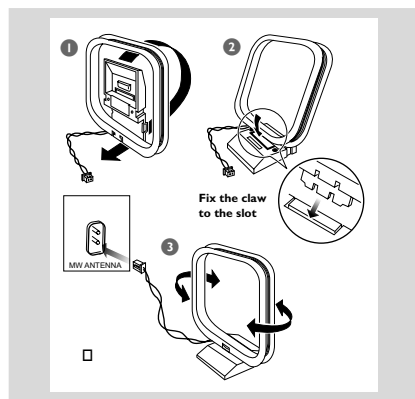

- Position the antenna as far as possible from a TV, VCR or other radiation source.

FM Antenna

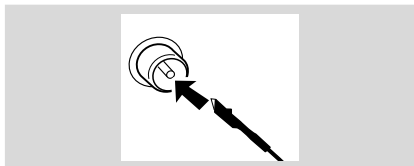

- For better FM stereo reception, connect an outdoor FM antenna to the FM ANTENNA terminal.

C Speakers Connection

Front Speakers

Connect the speaker wires to the SPEAKERS terminals, right speaker to "R" and left speaker to "L", coloured (marked) wire to "+" and black (unmarked) wire to "-".

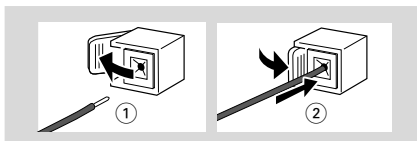

- Fully insert the stripped portion of the speaker wire into the terminal as shown.

Notes:

- For optimal sound performance, use the supplied speakers.
- Do not connect more than one speaker to any one pair of + / - speaker terminals.
- Do not connect speakers with an impedance lower than the speakers supplied. Please refer to the SPECIFICATIONS section of this manual.

Optional connection

The optional equipment and connecting cords are not supplied. Refer to the operating instructions of the connected equipment for details.

Connecting other equipment to your system

Use a cinch cable to connect **AUX** to the analogue audio out terminals of an external equipment (TV, VCR, Laser Disc player, DVD player or CD Recorder).

Note:

- If you are connecting equipment with a mono output (a single audio out terminal), connect it to the AUX left terminal. Alternatively, you can use a "single to double" cinch cable (the output sound still remain mono).

Inserting batteries into the remote control

Insert two batteries (Type R03 or AAA) into the remote control with the correct polarity as indicated by the "+" and "-" symbols inside the battery compartment.

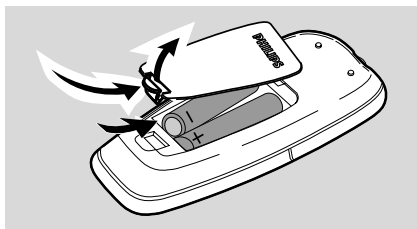

CAUTION!

- Remove batteries if they are exhausted or will not be used for a long time.
- Do not use old and new or different types of batteries in combination.
- Batteries contain chemical substances, so they should be disposed of properly.

Controls (illustrations on page 3)

Controls on the system and remote control

① STANDBY-ON/ ECO POWER (⏻)

- switches the system on or to Eco Power standby/normal standby with clock display.

② Source selection – to select the following:

DISC (CD 1/2/3)

- to select disc tray 1, 2 or 3.

TUNER

- to select waveband: FM or MW.

TAPE

- to select tape deck.

AUX

- to select the input for an additional appliance: AUX.

③ iR SENSOR

- infrared sensor for remote control.

④ VOLUME (VOL +/-)

- to increase or decrease the volume.

⑤ DBB

- to select the desired bass boost level. (DBB 1, DBB 2, DBB 3 or DBB OFF).

⑥ DSC

- Selects different types of preset sound equaliser settings (OPTIMAL, TECHNO, ROCK or JAZZ).

⑦ DISC 1/2/3

- to select a disc tray for playback.

⑧ Display screen

- to view the current status of the system.

⑨ OPEN•CLOSE

- to open or close the disc tray.

⑩ PROGRAM

- for CD/ MP3-CD ..to programme disc tracks.
- for Tunerto programme preset radio stations.

⑪ Mode Selection

ALBUM (- / +) ◀▶▶ SEARCH•TUNING

- for MP3-CDto select previous/next album.
- for CD/ MP3-CD .. (press and hold) to search backward/forward.
- for Tunerto tune to a lower or higher radio frequency.
- for Clockto set the hour.

STOP ■

- for CD/ MP3-CD ..to stop playback or to clear a programme.
- for Tuner (on the system only) to stop programming.
- for Demo (on the system only) to activate/deactivate the demonstration.
- for Clockto exit clock setting.
- for Plug&Play (on the system only) to exit plug&play mode.

PLAY•PAUSE ▶ II

- for CD/ MP3-CD ..to start or interrupt playback.

PRESET ◀|▶ (TITLE)

- for MP3-CDto select previous/next title.
- for CDto skip to the beginning of the current, previous, or next track.
- for Tunerto select a preset radio station.
- for Clockto set the minute.

⑫ DISC CHANGE

- to change disc(s).

⑬ CLOCK•TIMER

- to view the clock.
- set the clock or set the timer (on the set only).

⑭

- to connect headphones.

- ⑮ **MIC IN**
 - to connect microphone
- ⑯ **MIC VOLUME**
 - to adjust the mixing level for Karaoke
- ⑰ **Tape Deck Operation**
 - RECORD ●** ... starts recording.
 - PLAY ►** starts playback.
 - SEARCH ◀◀ / ▶▶** fast rewinds/winds the tape.
 - STOP•OPEN ■ ▲**
 - stops the tape; opens the tape compartment.
 - PAUSE II** interrupts recording or playback.
- ⑱ **Disc tray**
- ⑲ **DISPLAY**
 - to select disc information display mode.
- ⑳ **DIM MODE**
 - to select different brightness for the display screen : DIM 1, DIM 2, DIM 3 or DIM OFF.
- ㉑ **SLEEP (TIMER ON/OFF)**
 - to activate/deactivate or set the sleep timer.
 - activates/deactivates the timer function.
- ㉒ **REPEAT**
 - to playback track(s)/disc(s)/programme repeatedly.
- ㉓ **SHUFFLE**
 - turns on/off the random play mode.
- ㉔ **MUTE**
 - mutes or restores the volume.

Notes for remote control:

- *First, select the source you wish to control by pressing one of the source select keys on the remote control (CD or TUNER, for example).*
- *Then select the desired function (► II, ◀, ▶, for example).*

Basic Functions

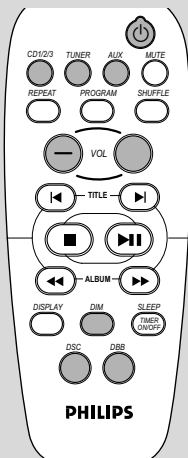

IMPORTANT!

Before you operate the system, complete the preparation procedures.

Plug and Play (for tuner installation)

Plug and Play allows you to store all available radio stations automatically.

First time setup/power up

- 1 When you turn on the main supply, "AUTO INSTALL - PRESS PLAY" is displayed.
- 2 Press ►|| to start installation.
→ "PLUG AND PLAY" "INSTALL" is displayed, followed by "TUNER" and "AUTO".
→ PROG starts flashing.
→ All available radio stations with sufficient signal strength will be stored automatically, starting from FM and followed by MW band.
→ When all the available radio stations are stored or the memory for 40 presets are used, the first preset radio station will be played.

To reinstall Plug and Play

- 1 In standby or demonstration mode, press and hold ►|| on the system until "AUTO INSTALL - PRESS PLAY" is displayed.

- 2 Press ►|| again to start installation.
→ All previously stored radio stations will be replaced.

To exit without storing the Plug and Play

- Press ■ on the system.
→ If you do not complete the Plug and Play installation, the function will be restarted when you next turn on the main supply again.

Notes:

- When the power is turned on, the disc tray may open and close to initialise the system.
- If no stereo frequency is detected during Plug and Play, "CHECK ANTENNA" will be displayed.
- During Plug and Play, if no button is pressed within 15 seconds, the system will exit Plug and Play mode.

Demonstration mode

The system has a demonstration mode that shows the various features offered by the system.

To activate the demonstration

- In **standby mode**, press and hold **STOP ■** for 5 seconds to switch to demonstration.

To deactivate the demonstration

- Press and hold **STOP ■** for 5 seconds to switch to standby mode.

Switching the system on

- Press **ECO POWER/STANDBY-ON ⏻**.
→ The system will switch to the last selected source.
- Press **DISC (CD 1/2/3), TUNER, TAPE** or **AUX**.
→ The system will switch to the selected source.
- Press **OPEN·CLOSE** or **DISC CHANGE**.
→ The system will switch to the disc source and the disc tray will open.

Switching the system to Eco Power Standby mode

- Press **ECO POWER/STANDBY-ON ⏻** in the active mode.
→ The system enters Eco power standby (the ECO POWER LED is on) or normal standby with clock display.
- The volume level (up to a maximum volume level of 20), interactive sound settings, last selected mode, source and tuner presets will be retained in the player's memory.
- If the system is in normal standby with clock display, press and hold **ECO POWER/STANDBY-ON ⏻** for 3 seconds or more to switch to Eco power standby or vice versa.

Power-saving automatic standby

As a power-saving feature, the system will automatically switch to Standby mode if you do not press any buttons within 15 minutes after a disc or tape has stopped playing.

Dim mode

You can select the desired brightness for the display.

- In any source mode (except Eco Power standby or standby mode), press **DIM MODE** repeatedly to select DIM 1, DIM 2, DIM 3 or DIM OFF display mode.
→ **DIM** is shown, except for DIM OFF mode.

DIM mode	Brightness	Spectrum Analyser
1	normal	off
2	half	on
3	half	off
OFF	normal	on

Volume control

Adjust **VOLUME** to increase (turn knob clockwise or press **VOLUME +** on the remote) or decrease (turn knob anti-clockwise or press **VOLUME -** on the remote) the sound level.

To listen through the headphones

- Connect the headphones plug to the  socket at the front of the system.
→ The speakers will be muted.



To switch off the volume temporarily

- Press **MUTE** on the remote control.
→ Playback will continue without sound and "MUTE" is displayed.
- To restore the volume, press **MUTE** again or increase the volume level.

Sound control

DSC (Digital Sound Control)

The DSC feature enables you to enjoy special sound effects that have preset equaliser settings, providing the best music reproduction.

- 1 Press **DSC** to select : OPTIMAL, TECHNO, ROCK or JAZZ.
→ The selected DSC is shown.

DBB (Dynamic Bass Boost)

There are three DBB settings to enhance the bass response.

- 1 Press **DBB** to select : DBB 1, DBB 2, DBB 3 or DBB OFF.
→ The selected **DBB** is shown, except for DBB OFF mode.

Note:

– Some discs or tapes might be recorded in high modulation, which causes a distortion at high volume. If this occurs, switch off DBB or reduce the volume.

Automatic DSC-DBB selection

The best DBB setting is generated automatically for each DSC selection. You can manually select the DBB setting that best suits your listening environment.

DSC	DBB
JAZZ	off
ROCK	on (3)
TECHNO	on (3)
OPTIMAL	on (2)

Karaoke

Connect a microphone (not supplied) to the system allowing you to sing along with the music source.

- 1 Connect a microphone to the **MIC** jack.
- 2 Before connecting the microphone, set the microphone **MIC VOLUME** to the minimum level to prevent howling sound.
- 3 Press **DISC (CD 1/2/3)**, **TUNER TAPE** or **AUX** to select the source to be mixed and start playback.
- 4 Adjust the volume level of the source with **MASTERVOLUME** control.
- 4 Adjust the microphone volume with the microphone **MIC VOLUME** control.

Note:

– Keep the microphone away from the speakers to prevent howling.

For Recording, please refer to “Tape Operation/Recording”.

IMPORTANT!

- This system is designed for regular discs. Therefore, do not use any accessories such as disc stabiliser rings or disc treatment sheets, etc., as offered on the market, because they may jam the changer mechanism.
- Do not load more than one disc into each tray.

Discs for playback

This system can playback all digital audio CD, finalised digital audio CD-Recordable (CDR) discs and finalised digital audio CD-Rewritable (CDRW) discs.
MP3-CDs (CD-ROMs with MP3 tracks)



About MP3 disc

Supported formats

- ISO9660, Joliet, Multisession
- Max. track number plus album is 512
- The max. MP3 program track number is 40
- Supported VBR bit-rate
- Supported sampling frequencies for MP3 disc are: 32 kHz, 44.1 kHz, 48 kHz
- Supported Bit-rates of MP3 disc are: 32, 64, 96, 128, 192, 256 (kbps)

Loading discs

- 1 Press **OPEN•CLOSE** to open the disc tray.
- 2 Load up to two discs on the individual disc trays. To load the third disc, press **DISC CHANGE**.
→ The disc tray will rotate until the empty tray is ready for loading.

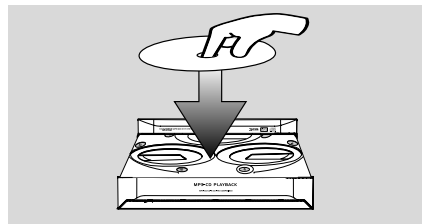

CD/MP3-CD Operations

- Press **OPEN•CLOSE** to close the disc tray.
→ **READING** is displayed as the CD player scans the contents of a disc, and then the total number of tracks and playing time (or the total number of albums and tracks for MP3 disc) are shown.

Notes:

- Load the discs with the label side facing up.
- To ensure good system performance, wait until the disc tray completely reads the disc(s) before proceeding.
- For MP3 disc, the disc reading time may exceed 10 seconds due to the large number of songs compiled into one disc.

Playing discs

To play current disc on the disc tray

- Press **PLAY•PAUSE ► II**.
 - All loaded discs will play once, then stop.
 - During playback, the selected disc tray, track number and elapsed playing time of the current track are displayed.
 - For mixed mode discs, only one mode will be selected for playback depending on the recording format.

Note:

– When playing a mixed mode disc, you may find a very short mute track inserted into the total number of tracks available in your disc.

To play the selected disc only

- In CD mode, press **DISC 1/2/3** (or **CD 1/2/3** on the remote control).
 - The current disc will play once, then stop.

To interrupt playback

- Press **PLAY•PAUSE ► II**.
 - The display freezes and the elapsed playing time flashes when playback is interrupted.
- To resume playback, press **PLAY•PAUSE ► II** again.

To stop playback

- Press **STOP ■**.

Text display during playback

In CD mode

- Press **DISPLAY** to show the current track number and remaining playback time.

In MP3-CD mode

- Press **DISPLAY** repeatedly to show the current album and track numbers followed by ID3 information (if available).

Replacing discs during playback

- 1 Press **DISC CHANGE**.
 - The disc tray will open without interrupting current playback.
- 2 To change the inner disc, press **DISC CHANGE** again.
 - "OPEN" is displayed and the disc will stop playing.
 - The disc tray will close to retrieve the inner disc, then reopen with the inner disc accessible.

Selecting a desired track/passage

To search for a particular passage during playback

- Press and hold **◀◀** or **▶▶** and release it when the desired passage is located.
 - During searching, the volume will be reduced.

To select a desired track

- Press **◀** or **▶** repeatedly until the desired track is displayed.
- If playback is stopped, press **PLAY•PAUSE ► II** to start playback.

Selecting a desired Album/Title (MP3 disc only)

To select a desired album

- Press **ALBUM -/+ (◀◀ / ▶▶)** repeatedly.

To select a desired title

- Press **TITLE -/+ (◀ / ▶)** repeatedly.

Different play modes: SHUFFLE and REPEAT

You can select and change the various play modes before or during playback. The play modes can also be combined with PROGRAMME.

- SHUFtracks of the entire disc are played in random order
- SHUF REP ALL...repeats the entire disc continuously in random order
- REP ALLrepeats the entire disc/ programme
- REPplays the current track continuously

- 1 To select your play mode, press the **SHUFFLE** or **REPEAT** button before or during playback until the display shows the desired function.
 - 2 Press **PLAY/PAUSE** **▶||** to start playback if in the STOP position.
→ If you have selected SHUFFLE, playback starts automatically.
 - 3 To return to normal playback, press the respective **SHUFFLE** or **REPEAT** button until the various SHUFFLE/ REPEAT modes are no longer displayed.
- You can also press **STOP** **■** to cancel your play mode.

Note:

– The **SHUFFLE** function cannot be used simultaneously with **PROGRAM**.

Programming the disc tracks

Programming tracks is possible when playback is stopped. Up to 40 tracks can be stored in the memory in any order:

- 1 Load the desired discs on the disc tray (refer to "Loading discs").
- 2 Press **DISC 1/2/3** (or **CD 1/2/3** on the remote control) to select a disc.
- 3 In stop mode, press **PROGRAM** to start programming.
→ **PROG** starts flashing.
- 4 Press **◀** or **▶** repeatedly to select the desired track.

- For MP3 disc, press **ALBUM** **-/+** and **TITLE** **-/+** to select the desired album and title for programming.
- 5 Press **PROGRAM** to store the track.
- 6 To end programming, press **STOP** **■** once.
→ **PROG** stays and the programme mode remains active.
- 7 To start programme play, press **PLAY/PAUSE** **▶||**

Notes:

- It is not possible to create a programme with MP3 tracks from multiple CDs, or combined with normal audio tracks.
- If you attempt to programme more than 40 tracks, "PROGRAM FULL" is displayed.
- During programming, if no button is pressed within 25 seconds, the system will exit the programme mode automatically.

To review the programme

- Stop playback and press **◀** or **▶** repeatedly.
- To exit review mode, press **STOP** **■**.

Erasing the programme

- Press **STOP** **■** once when playback is stopped or **twice** during playback.
→ **PROG** disappears and "CLEAR" is displayed.

Note:

– The programme will be erased when the system is disconnected from the power supply or when the disc tray is opened.

For Recording, please refer to "Tape Operation/Recording".



Tuning to radio stations

- 1 Press **TUNER** to select TUNER mode.
→ "TUNER" is displayed. A few seconds later, the current radio frequency will appear on the display.
- 2 Press **TUNER** again to select the desired waveband : FM or MW.
- 3 Press and hold ◀◀ or ▶▶ until the frequency indication starts to change, then release.
→ The display will show "SEARCH" until a radio station with sufficient signal strength is found.
- 4 Repeat step 3 if necessary until you find the desired radio station.
- To tune to a weak station, press ◀◀ or ▶▶ briefly and repeatedly until optimal reception found.

Storing preset radio stations

You can store up to 40 preset radio stations in the memory.

Automatic Preset Programming

- 1 Press **TUNER** to select TUNER mode.
To begin automatic preset from a desired preset number
- Press ◀ or ▶ to select the desired preset number.

- If a radio station has been stored in one of the presets, it will not be stored again under another preset number.
- 2 Press and hold **PROGRAM** until "AUTO" is displayed.
→ **PROG** starts flashing.
→ **AUTO** is displayed and available stations are programmed in order of waveband reception strength. The first preset automatically stored will then be played.
→ When all the available radio stations are stored or the memory for 40 presets are used, the last preset radio station will be played.

To stop storing the automatic preset

- Press **PROGRAM** or **STOP** ■ on the system.

Note:

– If no preset number is selected, automatic preset will begin from preset (1) and all your former presets will be overridden.

Manual Preset Programming

- 1 Tune to your desired radio station (refer to "Tuning to radio stations").
- 2 Press **PROGRAM**.
 - **PROG** starts flashing.
 - The next available preset number is displayed for selection.

To store the radio station to another preset number

- Press **◀** or **▶** to select the desired preset number.
- 3 Press **PROGRAM** again to store the radio station.
 - **PROG** disappears.
- Repeat **steps 1–3** to store other radio stations.

To exit manual preset mode

- Press **STOP ■** on the system.

Notes:

- If you attempt to store more than 40 preset radio stations, "PROGRAM FULL" is displayed.
- During programming, if no key is pressed within 25 seconds, the system will exit the programme mode automatically.

Tuning to preset radio stations

- Once you've programmed the radio stations, press **◀** or **▶** to select the desired preset number.
 - The preset number, radio frequency, and waveband are displayed.

For Recording, please refer to "Tape Operation/Recording".

Tape Operation/Recording

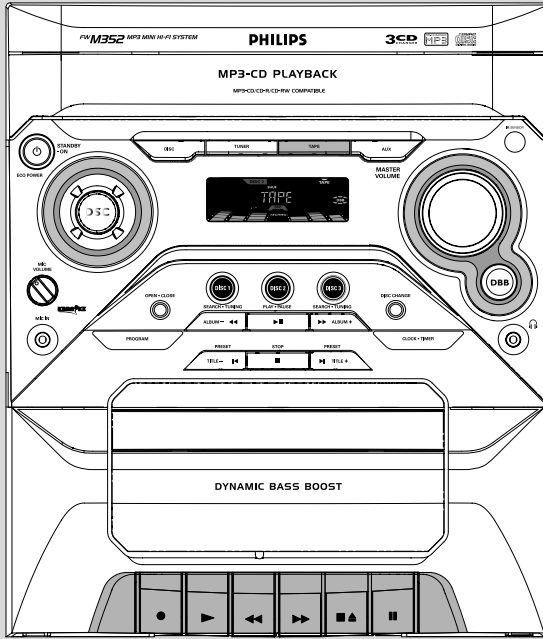

IMPORTANT!

- Before playing a tape, check and tighten slack tape with a pencil. Slack tape may get jammed or may burst in the mechanism.
- C-120 tape is extremely thin and is easily deformed or damaged. It is not recommended for use in this system.
- Store the tapes at room temperature and do not put them too close to a magnetic field (for example, a transformer, TV or speaker).

Tape playback

- 1 Select **TAPE** source.
- 2 Open the tape key flap marked "**OPEN ►**" on the front panel.
- 3 Press **STOP•OPEN ■▲** to open the tape door.
- 4 Insert a recorded tape and close the tape door.
- Load the tape with the open side downward and the full spool to the left.

- 5 Press **PLAY ►** to start playback.
 - The key is automatically released at the end of a tape, except if **PAUSEII** has been activated.
- 6 To pause, press **PAUSEII**. Press again to resume.
- 7 By pressing **◀◀** or **▶▶** on the system fast winding of tape is possible in both directions.
- 8 To stop the tape, press **STOP•OPEN ■▲**.

Note:

- The sound source cannot be changed while playing or recording a tape.

Tape Operation/Recording

General information on recording

- If you do not intend to record via the microphone, unplug the microphone to avoid accidental mixing with other recording source.
- Recording is permissible insofar as copyright or other rights of third parties are not infringed.
- For recording, use only NORMAL (IEC type I) tapes on which the tabs have not yet been broken. This deck is not suited for recording on METAL (IEC IV) type tapes.
- The recording level is set automatically, regardless of the position of the Volume, DBB, DSC and so forth.
- The recording sound quality might differ depending on the quality of your recording source and the recording tape.
- The tape is secured at both ends with leader tape. At the beginning and end of the tape, nothing will be recorded for six to seven seconds.
- To protect a tape from accidental erasure, have the tape in front of you and break out the left tab. Recording on this side is no longer possible. If, however, you wish to record over this side again, cover the tabs with a piece of adhesive tape.

Synchro start CD recording

- 1 Select **CD** source.
- 2 Insert a disc and if desired, programme track numbers.
- 3 Press **STOP•OPEN ■ ▲** to open the tape door.
- 4 Insert a suitable tape into the deck and close the tape door.
- 5 Press **RECORD ●** to start recording.

To select and record a particular passage within a CD track:

- Press and hold down on **I◀◀ ▶▶I**. Release the control when you recognize the passage you want.
- To pause CD playback press **PLAY/PAUSE ■■**
- Recording starts from this exact point in the track when you press **RECORD ●**.
- 6 To pause, press **PAUSE ■■** Press again to resume.
- 7 To stop recording, press **STOP•OPEN ■ ▲**.

Recording from the radio

- 1 Tune to the desired radio station (see Tuning to radio stations).
- 2 Press **STOP•OPEN ■ ▲** to open the tape door.
- 3 Insert a suitable tape into the deck and close the tape door.
- 4 Press **RECORD ●** to start recording.
- 5 To interrupt playback press **PAUSE ■■** To resume, press this key again.
- 6 To stop recording, press **STOP•OPEN ■ ▲**.

The making of unauthorized copies of copy-protected material, including computer programmes, files, broadcasts and sound recordings, may be an infringement of copyrights and constitute a criminal offence. This equipment should not be used for such purposes.



Be responsible
Respect copyrights

Tape Operation/Recording

Maintenance

Cleaning the Cabinet

- Use a soft cloth slightly moistened with a mild detergent solution. Do not use a solution containing alcohol, spirits, ammonia or abrasives.

Cleaning Discs

- When a disc becomes dirty, clean it with a cleaning cloth. Wipe the disc from the centre out.
- Do not use solvents such as benzene, thinner, commercially available cleaners, or antistatic spray intended for analogue records.



Cleaning the disc lens

- After prolonged use, dirt or dust may accumulate at the disc lens. To ensure good playback quality, clean the disc lens with Philips CD Lens Cleaner or any commercially available cleaner. Follow the instructions supplied with cleaner.

Cleaning the Heads and the Tape Paths

- To ensure good recording and playback quality, clean the heads (A), the capstan(s) (B), and pressure roller(s) (C) after every 50 hours of tape operation.
- Use a cotton swab slightly moistened with cleaning fluid or alcohol.
- You can also clean the heads by playing a cleaning tape once.

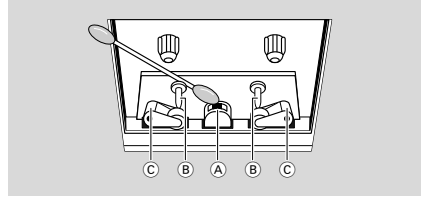

Demagnetising the heads

- Use a demagnetising tape available at your dealer.

External Sources

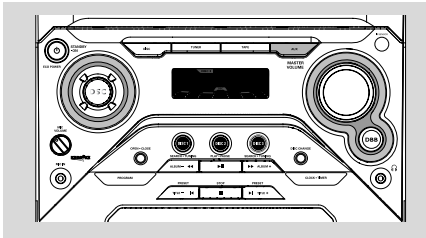

Note:

- All the sound control features (DSC or DBB, for example) are available for selection.
- Refer to the operating instructions for the connected equipment for details.

For Recording, please refer to "Tape Operation/Recording".

Listening to external sources

- 1 Connect the audio out terminals of the external equipment (TV, VCR, Laser Disc player, DVD player or CD Recorder) to the **AUX** terminals of your system.
- 2 Press **AUX** to select external equipment.
→ "AUX" is displayed.

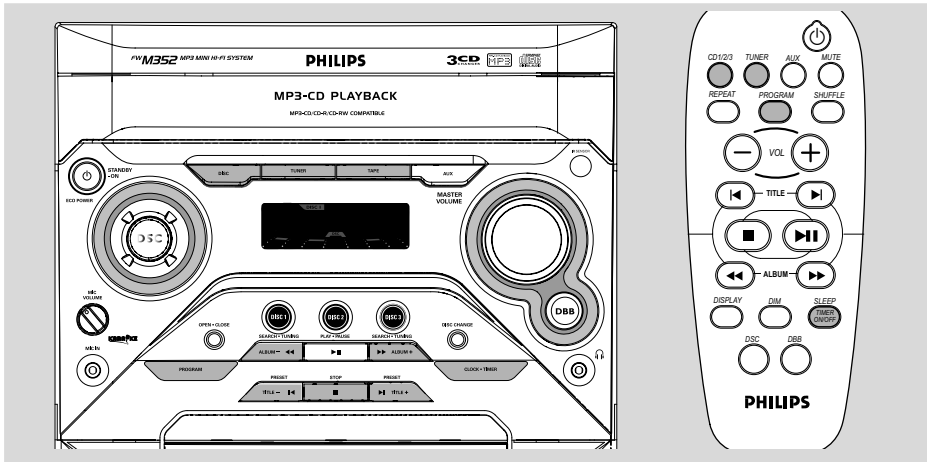

IMPORTANT!

– When in Eco Power standby mode, it is not possible to operate the clock or timer function.

Clock setting

The system only supports 24-hour time mode.

- 1 In standby or view clock mode, press **CLOCK•TIMER** once. In other source mode, press **CLOCK•TIMER** twice.
- 2 Press **◀▶** repeatedly to set the hour.
- 3 Press **◀▶** repeatedly to set the minute.
- 4 Press **CLOCK•TIMER** again to store the setting.
→ The clock starts working.

To exit without storing the setting

- Press **STOP ■** on the system.

Notes:

- The clock setting will be cancelled when the power cord is disconnected or if a power failure occurs.
- During clock setting, if no button is pressed within 25 seconds, the system will exit clock setting mode automatically.

Timer setting

The system can switch on to CD or TUNER mode automatically at a preset time, serving as an alarm to wake you up.

IMPORTANT!

– Before setting the timer, ensure that the clock is set correctly.

- 1 Press and hold **CLOCK•TIMER** for more than **two seconds** to select timer mode.
→ The last timer setting starts flashing.
→ The selected source will be lighted.
- 2 Press **DISC (CD 1/2/3)** or **TUNER** to select the desired source.
- Before setting timer, make sure the music source has been prepared.
CD – Load the disc(s). To start from a specific track, make a programme (refer to "CD Operation - Programming the disc tracks").
TUNER – tune to the desired radio station.
- 3 Press **◀▶** repeatedly to set the hour for the timer to start.

Clock/Timer

- 4 Press **◀** or **▶** repeatedly to set the minute for the timer to start.
- 5 Press **CLOCK•TIMER** to store the start time.
- At the preset time, the selected source will play.

To exit without storing the setting

- Press **STOP ■** on the system.

Notes:

- When the preset time is reached and the selected disc tray is empty, the next available disc will be selected. If all the disc trays are not available, Tuner will be selected automatically.
- During timer setting, if no button is pressed within 25 seconds, the system will exit timer setting mode automatically.

To deactivate the TIMER

- Press and hold **SLEEP (TIMER ON/OFF)** on the remote control.
→ The display will show "OFF" and  will disappear from the display.

To activate the TIMER

- Press and hold **SLEEP (TIMER ON/OFF)** on the remote control.
→ The last set timer information will be shown for a few seconds and  will appear on the display.

Sleep timer setting

The sleep timer enables the system to switch to standby mode automatically at a preset time.

- 1 Press **SLEEP (TIMER ON/OFF)** on the remote control repeatedly to select a preset time.
→ The selections are as follows (time in minutes):
15 → 30 → 45 → 60 → OFF → 15 ...
- 2 When you reach the desired length of time, stop pressing the **SLEEP (TIMER ON/OFF)** button.
→ **ZZZ** is shown, except for "OFF" mode.
→ The sleep timer is now set.

To check the remaining length of time after sleep timer is activated

- Press **SLEEP (TIMER ON/OFF)** once.

To change the preset sleep timer

- Press **SLEEP (TIMER ON/OFF)** again while the remaining sleep timer is shown.
→ The display will show the next sleep timer options.

To deactivate the sleep timer

- Press **SLEEP (TIMER ON/OFF)** repeatedly until "OFF" is displayed, or press **STANDBY-ON/ ECO POWER (⏻)**.

Note:

- **ZZZ** will start flashing when the remaining length of time after activation of the sleep timer is less than 1 minute.

AMPLIFIER

Output power	2 x 60 W MPO
.....	2 x 30 W RMS ⁽¹⁾
Signal-to-noise ratio	≥ 60 dBA (IEC)
Frequency response	125 – 16000 Hz
Input sensitivity	
AUX/CDR In	500 mV
Microphone	3.5 mV
Output	
Speakers	≥ 6 Ω
Headphones	32 Ω
(1) (6 Ω, 1 kHz, 10%THD)	

CD/MP3-CD PLAYER

Number of programmable tracks	40
Frequency response	125 – 16000 Hz -3dB
Signal-to-noise ratio	≥ 75 dBA
Channel separation	≥ 50 dB (1 kHz)
Total harmonic distortion	< 0.6%
MPEG 1 Layer 3 (MP3-CD)	MPEG AUDIO
MP3-CD bit rate	32-256 kbps
	(128 kbps advised)
Sampling frequencies	32, 44.1, 48 kHz

TUNER

FM wave range	87.5 – 108 MHz
MW wave rang	531 – 1602 kHz
Number of presets	40
Antenna	
FM	75 Ω wire
MW	Loop antenna

TAPE PLAYER

Frequency response	
Normal tape (type I)	125 – 8000 Hz (8 dB)
Signal-to-noise ratio	
Normal tape (type I)	≥ 40 dBA
Wow and flutter	≤ 0.4% JIS

SPEAKERS

System 1-way; 1 port bass reflex	
Impedance	6 Ω
Woofer	1 x 5.25"
Tweeter	1 x 2"
Dimensions (w x h x d) ..	222 x 310 x 220 (mm)
Weight	2.9 kg each

GENERAL

Material/finish	Polystyrene/Metal
AC Power	220 – 240 V / 50 Hz
Power Consumption	
Active	70 W
Standby	≤ 15 W
Eco Power standby	≤ 1 W
Dimensions (w x h x d) ..	265 x 310 x 384 (mm)
Weight (without speakers)	5.7 kg

Specifications and external appearance are subject to change without notice.

Troubleshooting

WARNING

Under no circumstances should you try to repair the system yourself, as this will invalidate the warranty. Do not open the system as there is a risk of electric shock.

If a fault occurs, first check the points listed below before taking the system for repair. If you are unable to remedy a problem by following these hints, consult your dealer or Philips for help.

Problem	Solution
"NO DISC" is displayed.	<ul style="list-style-type: none">✓ Insert a disc.✓ Check if the disc is inserted upside down.✓ Wait until the moisture condensation at the lens has cleared.✓ Replace or clean the disc, see "Maintenance".✓ Use a finalized CD-RW or a correct MP3-CD format disc.
"DISC NOT FINALIZED" is displayed.	<ul style="list-style-type: none">✓ Use a finalised CD-RW or CD-R.
Radio reception is poor.	<ul style="list-style-type: none">✓ If the signal is too weak, adjust the antenna or connect an external antenna for better reception.✓ Increase the distance between the Mini HiFi System and your TV or VCR.
Recording or playback cannot be made.	<ul style="list-style-type: none">✓ Clean deck parts, see "Maintenance".✓ Use only NORMAL (IEC I) tape.✓ Apply a piece of adhesive tape over the missing tab space.
The system does not react when buttons are pressed.	<ul style="list-style-type: none">✓ Remove and reconnect the AC power plug and switch on the system again.
Sound cannot be heard or is of poor quality.	<ul style="list-style-type: none">✓ Adjust the volume.✓ Disconnect the headphones.✓ Check that the speakers are connected correctly.✓ Check if the stripped speaker wire is clamped.✓ Make sure the MP3-CD was recorded within 32-256 kbps bit rate with sampling frequencies at 48 kHz, 44.1 kHz or 32 kHz.
The left and right sound outputs are reversed.	<ul style="list-style-type: none">✓ Check the speaker connections and location.

The remote control does not function properly.

- ✓ Select the source (CD or TUNER, for example) before pressing the function button (▶, ◀, ▶).)
- ✓ Reduce the distance between the remote control and the system.
- ✓ Insert the batteries with their polarities (+/- signs) aligned as indicated.
- ✓ Replace the batteries.
- ✓ Point the remote control directly towards the IR sensor.

The time is not working.

- ✓ Set the clock correctly.
- ✓ Press and hold TIMER ON/OFF to switch on the timer.
- ✓ If recording or tape dubbing is in progress, stop recording.

Not all lighted buttons are showing light.

- ✓ Press DIM to select DIM OFF display mode.

The Clock/Timer setting is erased.

- ✓ Power has been interrupted or the power cord has been disconnected. Reset the clock/timer.