



COMPACT CD-R/RW DRIVE **CRW-70 SERIES**

OWNER'S MANUAL
BEDIENUNGSANLEITUNG
MODE D'EMPLOI
MANUAL DE INSTRUCCIONES



12x 8x 24x
CD-R CD-RW CD-ROM

English

Deutsch

Français

Español

FCC INFORMATION

COMPLIANCE INFORMATION STATEMENT

(DECLARATION OF CONFORMITY PROCEDURE)

Responsible Party: Yamaha Electronics Corporation, USA.
Address: 6660 Orangethorpe Avenue
Buena Park, CA 90620
Telephone: 714-522-9105
Fax: 714-670-0108
Type of Equipment: CD Recordable/Rewritable Drive
Model Name: CRW-70

This device complies with Part 15 of the FCC Rules.

Operation is subject to the following conditions:

- 1) this device may not cause harmful interference, and
- 2) this device must accept any interference received including interference that may cause undesired operation.

See user manual instructions if interference to radio reception is suspected.

FCC INFORMATION (U.S.A.)

1. IMPORTANT NOTICE: DO NOT MODIFY THIS UNIT!

This product, when installed as indicated in the instructions contained in this manual, meets FCC requirements. Modifications not expressly approved by Yamaha may void your authority, granted by the FCC, to use the product.

2. IMPORTANT: When connecting this product to accessories and/or another product use only high quality shielded cables.

Cable/s supplied with this product **MUST** be used. Follow all installation instructions. Failure to follow instructions could void your FCC authorization to use this product in the USA.

3. NOTE: This product has been tested and found to comply with the requirements listed in FCC Regulations, Part 15 for Class "B" digital devices. Compliance with these requirements provides a reasonable level of assurance that your use of this product in a residential environment will not result in harmful interference with other electronic devices. This equipment generates/uses radio frequencies and, if not installed and used according to the instructions found in the users manual, may cause interference harmful to the operation of other electronic devices. Compliance with FCC regulations does not guarantee that interference will not occur in all installations. If this product is found to be the source of interference, which can be determined by turning the product "OFF" and "ON", please try to eliminate the problem by using one of the following measures: Relocate either this product or the device that is being affected by the interference.

Utilize power outlets that are on different branch (circuit breaker or fuse) circuits or install AC line filter/s.

In the case of radio or TV interference, relocate/reorient the antenna. If the antenna lead-in is 300 ohm ribbon lead, change the lead-in to coaxial type cable.

If these corrective measures do not produce satisfactory results, please contact the local retailer authorized to distribute this type of product. If you can not locate the appropriate retailer, please contact Yamaha Electronics Corporation, USA, 6660 Orangethorpe Avenue, Buena Park, CA 90620 U.S.A.

LASER INFORMATION

Laser Product Class: Class 1
Laser Diode Properties
Wavelength: 780 – 787 nm
Pulse Durations and Max. Output at the lens of the Laser Pickup Unit
Read Mode: 0.85 mW (Continuous)
Write Mode: Max. 38 mW (for 424 ns, Min. Cycle 115.7 ns)

Laserprodukt-Klasse: Klasse 1
Eigenschaften der Laserdiode
Wellenlänge: 780 – 787 nm
Impulsdauer und max. Ausgang an der Linse der Laser-Abtasteinheit
Lesemodus: 0.85 mW (kontinuierlich)
Schreibmodus: Max. 38 mW (für 424 ns, Zyklusmin. 115,7 ns)

Classe du produit laser: Classe 1
Caractéristiques de la diode laser
Longueur d'onde: 780 – 787 nm
Durée des impulsions et sortie maximum depuis la lentille du bloc capteur optique
Mode de lecture: 0,85 mW (continue)
Mode de gravure: max. 38 mW (pour 424 ns, cycle min. 115,7 ns)

Clase de producto láser: Clase 1
Propiedades del diodo láser
Longitud de onda: 780 – 787 nm
Duración del pulso y potencia de salida máxima en el objetivo de la unidad captora láser
Modo de lectura: 0,85 mW (continua)
Modo de escritura: máx. 38 mW (para 424 ns, ciclo mínimo 115,7 ns)

CAUTION
 Use of controls or adjustments or performance of procedures other than those specified herein may result in hazardous radiation exposure.

ACHTUNG
 Halten Sie sich beim Bedienen und Einstellen der Bedienungselemente sowie bei der Bedienungsabfolge an die Anleitung, da sonst gefährliche Strahlen austreten können.

ATTENTION
 L'emploi de commandes, de réglages ou un choix de procédures différents des spécifications de cette brochure peut entraîner une exposition à d'éventuelles radiations pouvant être dangereuses.

PRECAUCION
 El usar los controles o ajustar o realizar procedimientos diferentes a los especificados aquí resultará en peligrosas exposiciones a la radiación.

VARO! AVATTAESSA JA SUOJALUKITUS OHITETTAESSA OLET ALTTINA NÄKYMÄTTÖMÄLLE LASERSÄTEILYLLE. ÄLÄ KATSO SÄTEESEEN.
WARNING! OSYNLIG LASERSTRÅLNING NÄR DENNA DEL ÄR ÖPPNAD OCH SPÄRREN ÄR URKOPPLAD. BETRAKTA EJ STRÅLEN. STRÅLEN ÄR FARLIG.

CAUTION - VISIBLE AND / OR INVISIBLE LASER RADIATION WHEN OPEN AND INTERLOCKS DEFEATED. AVOID EXPOSURE TO BEAM.
 VORSICHT! SICHTBARE UND / ODER UNSICHTBARE LASERSTRAHLUNG TRITT AUS, WENN DECKEL GEÖFFNET UND WENN SICHERHEITSVERRIEGELUNG ÜBERBRÜCKT IST. NICHT DEM STRAHLE AUSSETZEN.

CAUTION - VISIBLE AND / OR INVISIBLE LASER RADIATION WHEN OPEN AND INTERLOCKS DEFEATED. AVOID EXPOSURE TO BEAM.
 VARNING: SYNLIG OCH / ELLER OSYNLIG LASERSTRÅLNING NÄR DENNA DEL ÄR ÖPPNAD OCH SPÄRREN ÄR URKOPPLAD. STRÅLEN ÄR FARLIG.
 VARO! AVATTAESSA JA SUOJALUKITUS OHITETTAESSA OLET ALTTINA NÄKYMÄTTÖMÄLLE LASERSÄTEILYLLE. ÄLÄ KATSO SÄTEESEEN.
 VARNING: OSYNLIG OCH / ELLER OSYNLIG LASERSTRÅLNING NÄR DENNA DEL ÄR ÖPPNAD OCH SPÄRREN ÄR URKOPPLAD. BETRAKTA EJ STRÅLEN.
 VORSICHT! SICHTBARE UND / ODER UNSICHTBARE LASERSTRAHLUNG TRITT AUS, WENN DECKEL GEÖFFNET UND WENN SICHERHEITSVERRIEGELUNG ÜBERBRÜCKT IST. NICHT DEM STRAHLE AUSSETZEN.

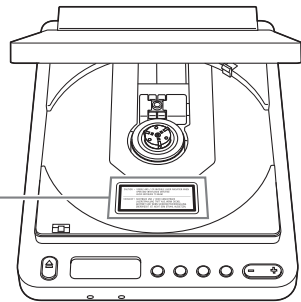

CLASS 1 LASER PRODUCT
 LASER KLASSE 1 PRODUKT
 LUOKAN 1 LASERLAITE
 CLASS 1 LASER APPARAT
 PRODUIT LASER DE CLASSE 1

COMPLIES WITH 21 CFR CHAPTER 1, SUBCHAPTER J.



**COMPACT CD-R/RW DRIVE
CRW-70 SERIES**



12x 8x 24x
CD-R CD-RW CD-ROM

English

OWNER'S MANUAL

SAFETY PRECAUTIONS

PLEASE READ THE FOLLOWING WARNINGS AND CAUTIONS CAREFULLY TO PREVENT PERSONAL INJURY AND DAMAGE TO THE DEVICE.

These precautions explain how to use the device correctly and safely, thereby preventing injury to yourself and others. This section has been sub-divided into a WARNING section and a CAUTION section, according to the likelihood and nature of any potential injuries or damage inflicted. They relate to your personal safety, and also help you minimize the risk of damaging the device. Please read these sections carefully before proceeding.

WARNING

Always follow these basic precautions to prevent short-circuit, damage, fire, or other hazards, and to prevent serious injury or death from electrical shock.

- To avoid risk of electrical shock or fire, do not attempt to open or disassemble the device.
- To avoid risk of eye damage or blindness, do not look directly at the laser source.
- To avoid the risk of personal injury or electrical shock, do not insert your fingers or foreign objects into the device. Take particular care if small children are present.
- To avoid the risk of electrical shock, fire, or personal injury, do not expose the device to rain, use it near water or in damp or wet conditions, or place containers of liquid (which may spill into the unit) on the device.
- To avoid risk of personal injury, electrical shock, fire, or damage to the unit, follow the Owner's Manual carefully and set up the unit correctly.
- If unusual smells, sounds or smoke come from the device, turn off the computer immediately to avoid the risk of electrical shock, fire or damage to the device, and return the device to the store of purchase or your nearest Yamaha dealer (listed at the back of this manual).
- When cleaning the drive, unplug the power cable first from the electrical outlet (do not touch the plug with wet hands) as there is an increased risk of electrical shock.

- The drive should not be exposed to temperatures outside the range 5 – 35 °C (41 – 95 °F) to avoid risk of malfunction, fire or personal injury.
- Clean the AC power plug regularly, especially the blades, to avoid the risk of insulation failure or fire due to humidity.
- Do not pull on the cord itself when disconnecting from the electrical outlet, or let objects rest or roll on the cord, as this can damage the cord and cause electrical shock or fire.
- Insert the AC plug firmly, as a poor connection can result in electrical shock or fire.
- Only use the AC adapter provided. Failure to do so can result in malfunction or fire.
- Do not connect too many devices to a single electrical outlet or use a voltage exceeding the rated voltage, as this may cause overheating and fire.



CAUTION

Always follow these basic precautions to prevent physical injury to yourself or others, and damage to the instrument or other property.

- Always unplug the computer from the electrical outlet if it will not be used for a prolonged period of time or if there is a possibility of lightning, to avoid the risk of electrical shock or fire.
- Do not expose the device to excessive vibration, heat, cold or dust. Doing so may result in damage to the unit's panel or internal components.
- Do not use the device near other appliances such as televisions or radios. Doing so may cause interference and affect the proper operation of the device or other appliance.
- To avoid damage to the device or personal injury, always place the device in a stable position.
- Always place the device horizontally to avoid the risk of lost written data.
- Always remove any disc from the drive before transporting the device as written data may be lost.

- Use a soft, dry cloth to wipe the device. Do not use benzene, paint thinners, detergents, or chemically treated wiping cloths as these may damage the unit. Do not place vinyl, plastic, or rubber objects on the device as chemical reactions can cause damage to the device.
- Do not rest your weight on or place heavy objects on the device, or use excessive force on the buttons, switches or connectors, as damage to the unit or personal injury may occur.
- Do not listen to audio with headphones at high volume for prolonged periods of time, as your hearing may be damaged as a result.
- Before use, always turn down the volume as a sudden burst of sound at high volume can result in hearing damage.
- Do not place the device anywhere near sources of magnetic interference as operational stability may be adversely affected.
- Have the device serviced regularly to avoid internal dust buildup that can cause malfunction, damage or fire. For service information and service charges, contact the store of purchase or your nearest Yamaha dealer (listed at the back of this manual).
- Do not allow the plug of the AC adapter to come into contact with metal as a short circuit can result and cause a malfunction or damage to the device.
- Do not wrap the power cord around the AC adapter as it may become disconnected and cause a malfunction.
- Do not touch the pickup as it can cause sounds to drop out or data cannot be written/read normally.

- **The information contained in this manual is subject to change without prior notice.**
- **All trademarks contained in this manual belong to their respective owners.**
- **Yamaha does not bear any responsibility for a problem that occurs as a result of any operations carried out other than those stated in the manual that came with the drive.**
- **Reproduction of this manual, either in part or in full, is expressly forbidden.**

■ Precautions for Transportation

Keep the original box for future transportation. Before transporting the device, always put it in the original box. Yamaha does not bear any responsibility for problems that occur during transportation with the device not in the original box.

■ WARRANTY

YAMAHA AND ITS SUPPLIERS ACCEPT NO LIABILITY FOR THE LOSS OF ANY DATA OR ANY PROBLEMS CAUSED AS A RESULT OF USING THIS PRODUCT. AS A PRECAUTION, IT IS RECOMMENDED THAT THE DISCS BE TESTED AFTER THEY HAVE BEEN WRITTEN TO. FURTHERMORE, UNDER NO CIRCUMSTANCES DOES YAMAHA AND ITS SUPPLIERS GUARANTEE THE RELIABILITY OF THE DISCS.

©2001 YAMAHA CORPORATION. All Rights Reserved.
This document may not, in whole or in part, be copied, photocopied, reproduced, translated, transmitted, or reduced to any electronic medium of machine readable form without prior consent in writing from Yamaha.
Windows is a registered trademark of Microsoft Corporation.
SafeBurn™ is a trademark of Yamaha Corporation.
All other trademarks are the property of their respective companies.

Table of Contents

Handling Discs and Data	1
Handling Discs.....	1
Copyright	1
Disclaimer of Indemnity	1
Supported Discs	2
Features of the CRW-70 Drive	5
Before Use.....	9
System Requirements	9
Serial Number.....	11
Exterior Features.....	12
Loading/Removing a Disc	15
Loading a Disc	15
Removing a Disc.....	16
Using the CRW-70 Drive as a CD-R/RW Drive (When Connected to a Computer) ..	17
Setup Procedure (Flowchart)	17
STEP 1 Connect the CRW-70 Drive	18
STEP 2 Install the Device Drivers.....	21
STEP 3 Make Sure that the CRW-70 Drive Is Correctly Recognized ...	22
STEP 4 Install the CD Writing Software	24
Disconnecting the CRW-70 Drive.....	24
Listening to Audio CDs and MP3 Discs	25
CDs/MP3 Discs that Can Be Played on the CRW-70 Drive	25
Connecting.....	27
Playback.....	28
Pause During Playback.....	29
Skip.....	30
Changing the Playback Mode.....	31
Troubleshooting	32
Appendix.....	39
Recording Methods.....	39
Firmware.....	42
Relationship Between Busy LED and Operation	43
Relationship Between Display and Operation.....	44
CRW-70 Drive Specifications	45
Index	49

Handling Discs and Data

Handling Discs

To avoid trouble such as writing errors, the loss of recorded data, and a breakdown in the drive, take the following precautions when handling discs.

- Do not place discs in a hot or damp place or where they will be exposed to direct sunlight.
- Do not touch the surface of a disc.
When handling a disc, hold it by the edges.
- Remove dust and dirt from the surface of a disc.
Use an air spray to remove dust. The surface of a disc may be scratched if strongly wiped with a dry cloth.
- Do not stick labels to the surface of a disc or write anything on it except where designated.
- Do not clean discs with chemicals or detergents.
- Do not bend or drop discs.
- Use only circular discs^{*1}. Do not use irregularly shaped discs, such as star or heart shaped discs.

^{*1} Suitable for 8cm CDs.

Copyright

It is prohibited by law to duplicate copyrighted materials for non-personal use without the prior consent of the copyright holder. When copying material with your CD-R/RW drive, take due care not to infringe the copyright.

Disclaimer of Indemnity

Yamaha assumes no liability for the loss of any profits incurred as a result of the loss or corruption of data written on a CD-R or CD-RW, for any loss or damage caused by or arising out of extraordinary circumstances (including circumstances that Yamaha has foreseen or could foresee), or for any damages incurred to cover the damages claimed by a third party. After handling important data, you should always make a comparison between the original and the copied data to confirm that the data has been copied properly. In no event shall Yamaha be liable for any damage to discs due to a Buffer Underrun Error (→P. 7) or any other reason, or the inability to use distributed discs with your drive because of their formats.

Supported Discs

The CRW-70 drive can write on discs that carry the following logos:
For the latest information about discs already checked for compatibility with the drive, go to the YAMAHA CD-R/RW Drive web site.

URL: <http://www.yamaha.co.jp/english/product/computer/>



CD-R discs

- The CRW-70 drive can write onto these discs at 1X, 2X, 4X, 8X or 12X speed.
- These discs can be read/played on a CD-ROM drive or a CD player.



Notes

- 12X-speed writing is enabled with Partial CAV method. (→P. 4)
- Before writing, check the writing speeds your disc supports.



CD-RW discs

- The CRW-70 drive can write/rewrite at 2X or 4X speed.
- These discs can be read/played on a device (e.g. CD-ROM drive) that supports “CD-RW.”

Note

Note that some discs support only 2X speed.



High Speed CD-RW discs

- The CRW-70 drive can write/rewrite at 4X or 8X speed.
- These discs can be read/played on a CD-RW drive that bears the High Speed CD-RW logo or a device (e.g. CD-ROM drive) that supports “CD-RW.”

Notes

- When using the packet writing method (→P. 41) for writing/rewriting onto High-Speed CD-RW discs, you can select the 4X – 10X Full CAV method. For more information, refer to the documentation that came with your CD writing software. (Your CD writing software must support the Full CAV method, as does the CD writing software that came with the CRW-70 drive.)
- The Full CAV method is recommended when opening and editing a file on a CD-RW disc with an application.
- In order to write, erase, read or play High Speed CD-RW discs, use a CD-R/RW drive that bears the High Speed CD-RW logo. When using a CD-ROM drive to read/play High Speed CD-RW discs, use a drive that supports CD-RW discs. If these discs are used with a CD-R/RW drive not bearing the High Speed CD-RW logo, the discs may not be recognized, resulting in the computer not operating correctly or other malfunctions occurring.
Refer to the page at the URL below before attempting to read/play these discs on a Yamaha CD-R/RW drive not bearing the High Speed CD-RW logo.
URL: <http://www.yamaha.co.jp/english/product/computer/>

What is Orange Book?

The Orange Book is a collection of standards for CD-R and CD-RW, and sometimes refers to the standards themselves. The Orange Book Part 2 deals chiefly with CD-R discs, and the Orange Book Part 3 with CD-RW discs. The book takes its name from its orange colored cover.

Audio CDs and CD-ROMs

Ordinary audio CDs that can be played back on a CD player contain sounds or music data recorded in a format called CD-DA (Compact Disc-Digital Audio). This means that CD-R discs can also be played on a CD player if they store audio data recorded in CD-DA format. A 79-minute CD is capable of recording audio data of up to 79 minutes (16-bit/44.1 kHz-sampled stereo audio data).

On the other hand, CD-ROMs store computer data digitally encoded and recorded in a format specified by the international standard ISO9660 so that they can be recognized by many types of computers. CDs (CD-DA) were originally developed for music, later came into use as read-only memory (ROM) for computers, and are now widely used as a storage medium for recording audio and graphics data, and also for databanks and electronic publications.

Included among the CD-ROM variations are CD EXTRA and Video CDs.

What is CD EXTRA?

This refers to CDs containing audio data, text data, graphics data, etc., recorded in multiple sessions. Most CD EXTRA discs allow you to listen to music on an ordinary CD player or to enjoy pictures and text information on your computer, whereas Video CDs allow you to play back video and audio data compressed in MPEG1 format.

Partial CAV (Constant Angular Velocity)

The CLV (Constant Linear Velocity) method is generally used to write data on a CD-R disc. In writing by the CLV method, the disc rotation speed is adjusted to keep the data writing speed (data transfer rate) constant at any part of the disc.

In contrast, the CAV method (Constant Angular Velocity) method exercises control so as to keep the disc rotation speed constant. The CAV method makes it possible to substantially increase the maximum data transfer rate with a minimum increase in the load to the drive, and for this advantage, it is adopted today for most play-only CD-ROM drives.

Since a CD is formatted so that it has an even data recording density at all of its parts, the amount of data recorded in a track increases as the read/write head moves outward on the disc. For the CAV method, therefore, data is transferred at a higher rate when it is written in tracks at the outer radius of the disc.

To achieve up to 12X-speed writing, the CRW-70 drive employs the Partial CAV method, which is a combination of the CAV method used for writing in inner tracks and the CLV method used for writing in outer tracks. The Partial CAV method controls the disc rotation speed so that the CRW-70 drive starts writing at 8X speed in inner tracks, increases the speed to 12X as the read/write head moves outward, and holds the speed at 12X in outer tracks.

Features of the CRW-70 Drive

High speed writing/reading

The CRW-70 drive supports up to 12X-speed writing of CD-R discs^{*1}, and up to 8X-speed writing/rewriting of CD-RW discs. The drive also supports data reading and digital audio data extraction at up to 24X speed.

USB 2.0 compatible

USB 2.0 provides high-speed data transfer capability (max. speed 480 Mbits/sec.).

The transfer speed is about 40 times faster than the USB 1.1 standard.

USB's hot plug capability allows the drive to be plugged in and unplugged even with the computer turned on.

SafeBurn™ (Enhanced write stability technology)

Generous 8MB of buffer memory

Because of the large data storage area, stable disc writing is possible even at fast speeds.

Buffer Underrun Protection

When data transfer from the computer is interrupted, Buffer Underrun Protection is activated to keep precious CD-R discs from going to waste. (→P. 7)

Optimum Write Speed Control

Before writing to CD-R discs, the CRW-70 drive checks the disc's capability and automatically selects the optimum writing speed^{*2} for greater reliability. The speed you set with your CD writing software is the maximum writing speed.

Reliable writing

Yamaha's proprietary Pure-Phase Laser System (patent applied for)

This technology reduces phase interference of the laser beam, so that it projects accurately onto the disc. Jitter value, an important measure of recording quality, has been improved 25% compared with Yamaha models not using this technology.

Running OPC (Optimum Power Control)

Running OPC automatically adjusts the output of the laser according to the characteristics of the disc being used. Running OPC provides greatly enhanced recording reliability for various manufacturers' discs.

High-fidelity digital audio

The CRW-70 drive supports extraction of digital audio data at up to 24X speed, as well as the recording of digital sound with complete fidelity even when writing at 12X speed.

CD TEXT support

Information such as song names or artist names can be recorded on CD-R/RW discs using CD writing software. The text data on the created disc can be displayed on a CD player that is compatible with the CD TEXT format.

Audio CD and MP3 disc playback support

You can play audio CDs or MP3 discs (→P. 25) on the CRW-70 drive without connecting it to a computer, by using optional headphones or other audio device.

*1 12X-speed writing onto CD-R discs is enabled with the Partial CAV method.
(→P. 4)

*2 The optimal writing speed automatically selected will be between 8X speed and the maximum speed designated for that disc. If the disc is rated at lower than 8X-speed writing, you need to designate the most suitable writing speed manually.

Buffer Underrun defined

CD-R/RW drives are equipped with a buffer memory. This memory temporarily stores data while a disc is being recorded. When the buffer memory becomes empty (due to unexpected interruptions or the system's inability to keep up with the writing process), a writing error occurs. This error is known as a "buffer underrun error."

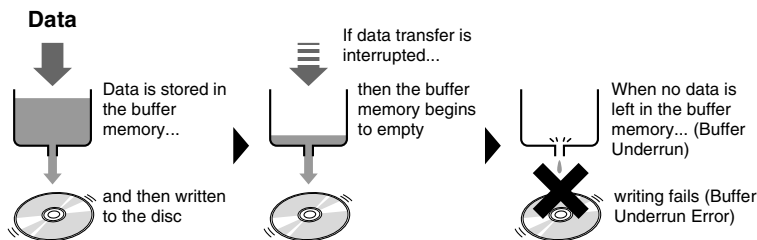

A Buffer Underrun Error will permanently ruin the disc.

Yamaha Buffer Underrun Protection

Buffer Underrun Protection is featured in the CRW-70 drive CD-R/RW drives. When a buffer underrun is about to occur, a buffer underrun error is prevented by temporarily suspending the writing process. Writing resumes when enough data has accumulated again in the buffer memory. Buffer Underrun Protection on the CRW-70 drive is extremely accurate, resulting in seamless recording between stop and continuation points.

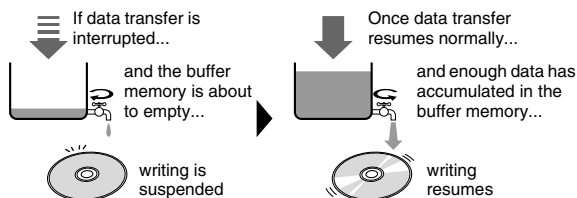

Yamaha Buffer Underrun Protection ensures error-free results.

Test writing for Buffer Underrun

Test writing is a function to check for the likely occurrence of Buffer Underrun on your computer system.

The CD writing software that came with the CRW-70 drive includes test writing functions for this purpose.

When Buffer Underrun Protection is activated (Default), test writing cannot be selected on your writing software.

To use test writing, Buffer Underrun Protection should be deactivated.

Before Use

System Requirements

When the CRW-70 drive is connected to a computer and used as a CD-R/RW drive, the system environments must satisfy the following conditions. If your computer does not meet the requirements listed below, the CRW-70 drive may not be able to write at the maximum speed.

Hardware

- PC/AT-compatible computer
- CPU: Pentium II-class or higher, 300 MHz or faster
- RAM: 64 MB or more
- USB port (USB 2.0 compatible)
- A spare PCI expansion slot or a CardBus slot for a USB interface card (if there is a need to install an USB interface card in your computer)
- CD-ROM drive

Notes

- To install the device drivers, you need a CD-ROM drive other than the CRW-70 drive.
- The CRW-70 drive cannot be used as a boot drive. Furthermore, the CRW-70 drive cannot be used to set up the operating system one more time.
- For Windows XP, use a RAM of 128 MB or more.

USB interface card

Your computer requires a USB port in order to connect the CRW-70 drive. To fully utilize the performance of the CRW-70 drive, a USB 2.0 compatible interface card and EHCI (Enhanced Host Controller Interface) compliant driver are also necessary. If your computer has a USB port with USB 1.1 specifications, YAMAHA recommend that you install a USB 2.0 compatible interface card.

Notes

- For the latest information about USB 2.0 interface cards already checked for compatibility with your drive, go to the YAMAHA CD-R/RW Drive web site. URL: <http://www.yamaha.co.jp/english/product/computer/>
- For information on how to purchase an EHCI compliant driver for the USB interface card, or information about the operating system supporting the card, go to the interface card manufacturer's web site or contact user support services.

Connecting the drive to a USB 1.1 port

If the CRW-70 drive is connected to a USB 1.1 port, which is one of the typical USB ports installed as standard on computers, the drive operates in accordance with USB 1.1 standard.

For reliable data writing, Buffer Underrun Protection should be activated and the writing speed should be set to 8X on the CD writing software.

With a USB 1.1 port, the data reading speed is 6X at maximum.

USB cable

Use the USB cable provided.

According to USB specifications, the maximum length for cables connecting devices is 5 m.

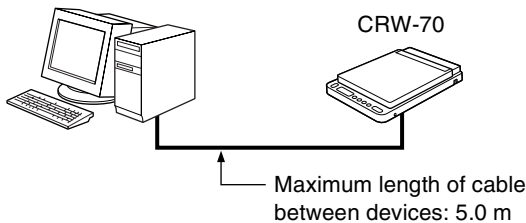

Note

Be sure to connect the drive to the USB port of the computer. If you connect the drive to the computer via a USB hub, the drive may not operate properly.

Operating system (OS)

Windows 98 Second Edition, Windows Me, Windows 2000 Professional, or Windows XP

Notes

- For Windows 98 Second Edition, install the device drivers provided (storage class drivers) in the computer. For details, refer to the separate manual "Device Driver Installation Guide," that came with the CRW-70 drive.
- The CRW-70 drive cannot be used with a system that has been booted in MS-DOS or Safe mode.

CD writing software

The CRW-70 drive requires CD writing software to write onto a CD-R/RW disc. Use the CD writing software that came with the CRW-70 drive. If you use different CD writing software, consult the manufacturer of the CD writing software to check the compatibility with the CRW-70 drive.

Note

For details about how to install and use the CD writing software, refer to the documentation that came with it.

Hard drive space

Writing data on a CD-R/RW disc requires 50 MB to 100 MB of free space as a working area on the hard drive. When writing data on a CD-R/RW disc after creating an image file, there must be enough free space on the hard drive to store the image file in addition to the working area (a total of up to about 900 MB). However, this hard drive space for image files is not needed when directly writing onto a CD-R/RW disc from a hard drive or CD-ROM using the CRW-70 drive (on-the-fly writing).

Image files

You can collect data files to be written on a CD-R/RW disc into a single image file. The image file is useful for writing the same data onto multiple discs. For further details, refer to the documentation that came with your CD writing software.

Serial Number

Your drive's serial number is printed on the label affixed to the bottom of the drive. You may be asked for the serial number when requesting information about your drive or user support services. It may be difficult to read the serial number because of the installation location or for other reasons. YAMAHA therefore recommend you note down the serial number in the box below for future reference.

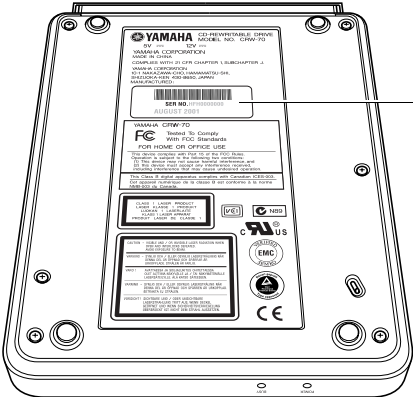

Serial number
(3 letters and 7 digits)

Serial No. [] [] [] [] [] [] [] [] []

Exterior Features

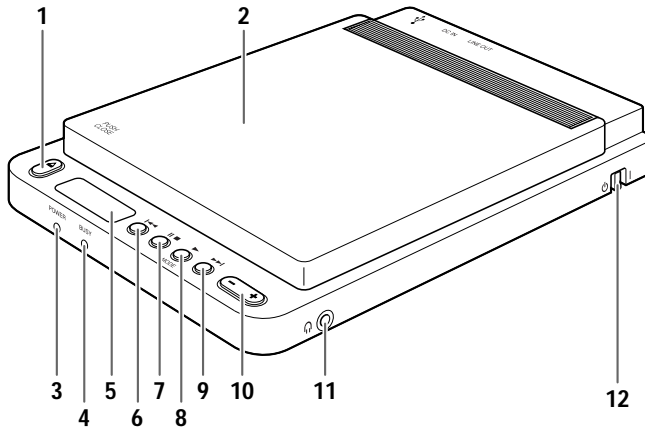

- 1 Eject (▲) button**
Used to open the top cover. (→P. 15, 16)
- 2 Top cover**
- 3 POWER LED**
Lights up orange when the CRW-70 drive is turned on. (→P. 20)
- 4 BUSY LED**
Indicates the operation status of the CRW-70 drive. (→P. 43)
- 5 Display**
Indicates the operation status of the CRW-70 drive. (→P. 14, 44)
- 6 Skip REW (◀◀) button**
Allows you to rewind to the beginning of a track. (→P. 30)
- 7 Pause/stop (|| ■) button**
Allows you to stop or pause a track. (→P. 29)
- 8 Play/mode (▶/MODE) button**
Allows you to start playback or select a playback mode. (→P. 28, 31)
- 9 Skip FF (▶▶) button**
Allows you to skip to the beginning of the next track. (→P. 30)
- 10 Volume (-/+ button**
Used to adjust the volume of the headphones when connected. (→P. 28)
- 11 Headphone (🎧) jack**
Enables you to connect headphones to the CRW-70 drive and listen to audio. Stereo mini-jack specifications. (→P. 27)
- 12 Power (⏻/⏻) switch**
Used to turn the CRW-70 drive on (⏻) or off (⏻). (→P. 18, 20)

* Use buttons **6 ~ 9** when using the CRW-70 drive as a CD/MP3 player.

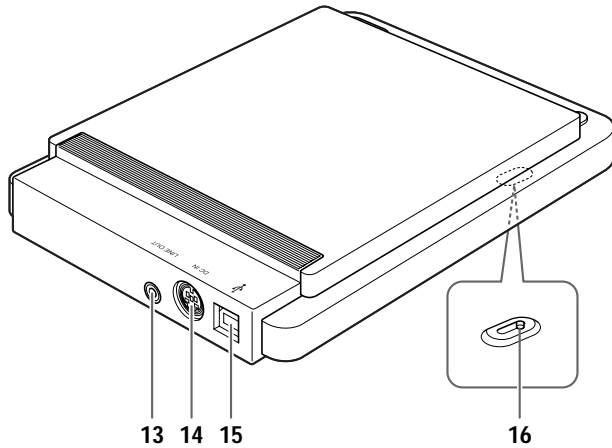

13 LINE OUT jack

Enables you to output sound to an audio device such as external speakers.

Stereo mini-jack specifications. (→P. 27)

14 DC IN connector

Used to connect the AC adapter provided. (→P. 19)

15 USB (ψ) port

Used to connect the USB cable provided. (→P. 18)

16 Manual eject lever

Used to eject the disc if it cannot be ejected normally. (→P. 34)

Display

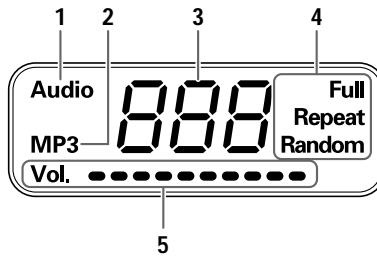

1 Audio display

Shows when an audio CD is loaded. (→P. 44)

2 MP3 display

Shows when an MP3 disc is loaded. (→P. 44)

3 Counter

(→P. 44)

4 Playback mode

Indicates the playback mode of a track. (→P. 31, 44)

The four playback modes are normal playback, one-track repeat playback, full repeat playback and random playback.

5 Volume indicator

The volume is indicated by a bar. (→P. 28, 44)

Loading/Removing a Disc

You cannot load or eject a disc when the CRW-70 drive is turned off.

Loading a Disc

1 Press the eject button.

The top cover opens. If it does not fully open, lift it up manually.

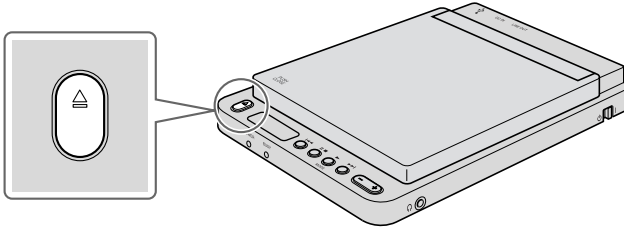

Note

Do not try to force the top cover open by hand. Doing so can damage the CRW-70 drive and the disc.

2 Load the disc.

Press the center of the disc onto the CRW-70 drive spindle until it clicks into place. Do not use excessive force or touch the pickup.

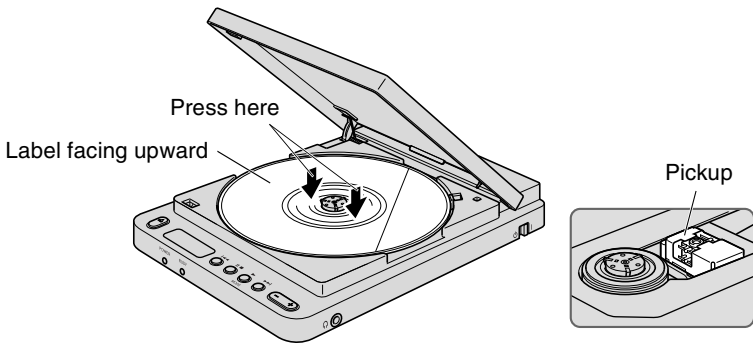

3 Close the top cover.

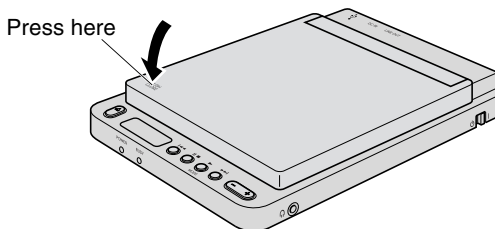

Removing a Disc

1 Press the eject button.

The top cover opens. If it does not fully open, lift it up manually.

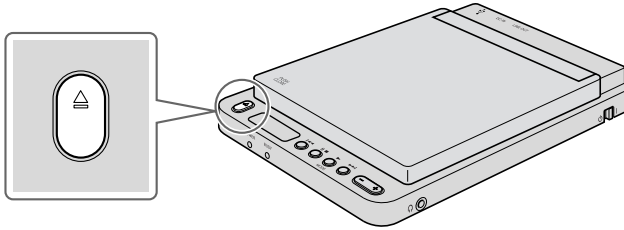

2 Remove the disc.

Press on the CRW-70 drive spindle and lift the disc up by the edge.

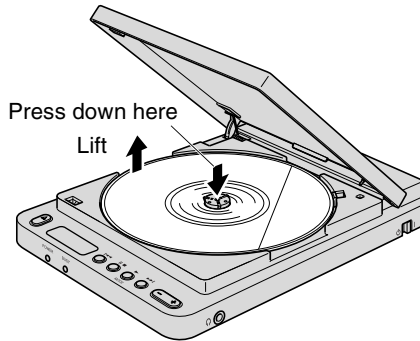

3 Close the top cover.

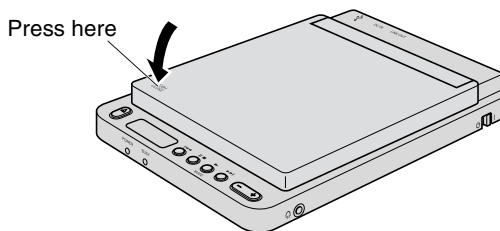

Note

Do not open the top cover during reading or writing. Doing so can prevent normal computer operation.

Using the CRW-70 Drive as a CD-R/RW Drive (When Connected to a Computer)

Setup Procedure (Flowchart)

The flowchart below shows the steps you need to follow to set up your CRW-70 drive.

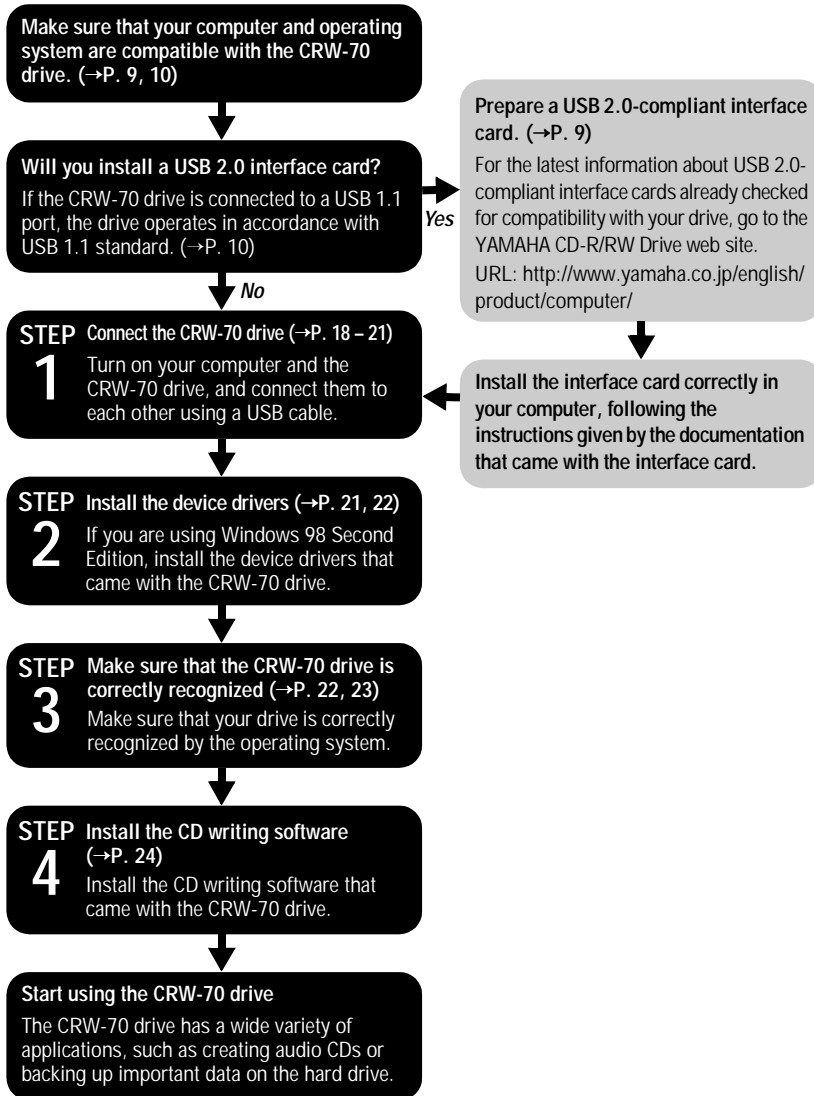

Always install the CRW-70 drive horizontally.

STEP 1 Connect the CRW-70 Drive

- 1 Turn on the computer.**
- 2 Check that the power switch of the CRW-70 drive is turned off.**

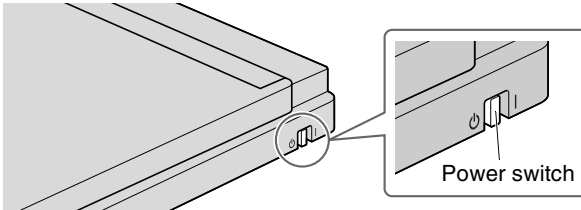

- 3 Connect the USB cable that came with the CRW-70 drive.**

The USB cable provided has two types of plug: a series A plug and a series B plug.

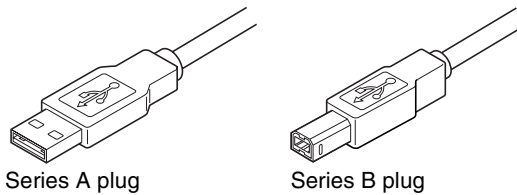

Insert the series B plug (with a square cross section) of the USB cable provided in the USB port of the CRW-70 drive.

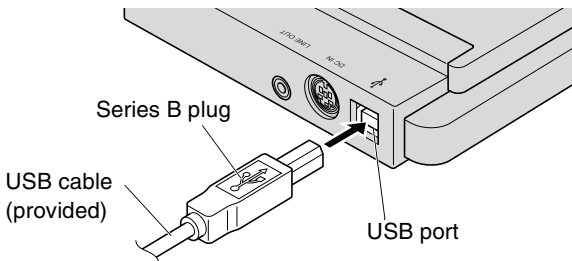

4 Connect the AC adapter provided to the DC IN connector of the drive.

Insert the AC adapter cable so that the arrow on the cable plug faces upwards.

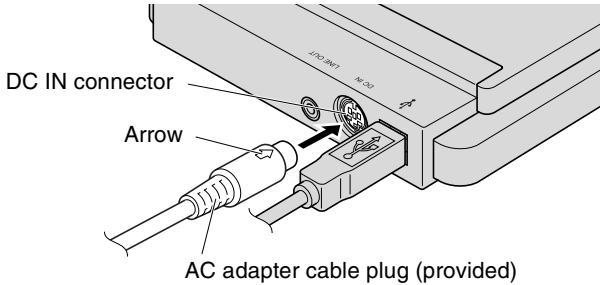

5 Connect the power cable provided to the AC adapter (①). Connect the other end of the power cable to the AC outlet (②).

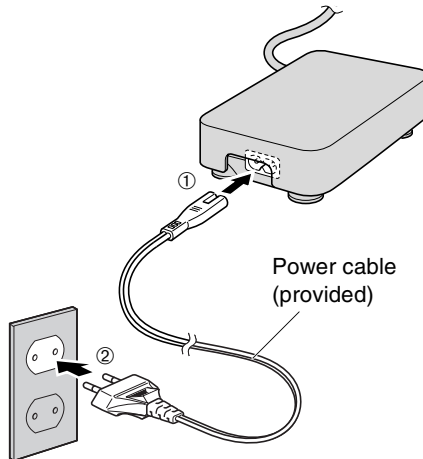

Notes

- Electrical plugs/sockets vary according to country/region.
- Only operate the drive with the AC adapter provided.
- The AC adapter may become hot during use. This is not a malfunction.
- When the AC adapter is connected to an AC outlet it continues to consume about 0.8 W of power even if the drive is turned off. Unplug the power cable from the AC outlet when you do not intend to use the CRW-70 drive for a long time.

6 Turn on the power switch of the CRW-70 drive.

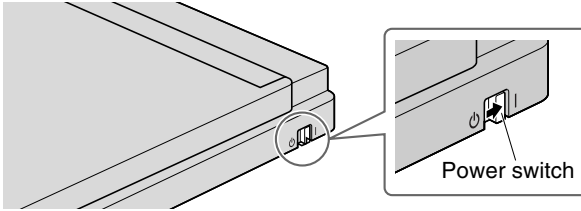

When the power is turned on, the power LED on the front panel lights up orange.

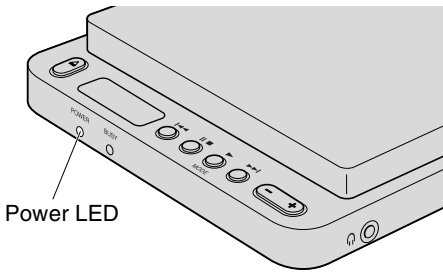

7 Connect the USB cable provided to the computer.

Insert the series A plug (with a rectangular cross section) of the USB cable provided in the USB port of the interface card.

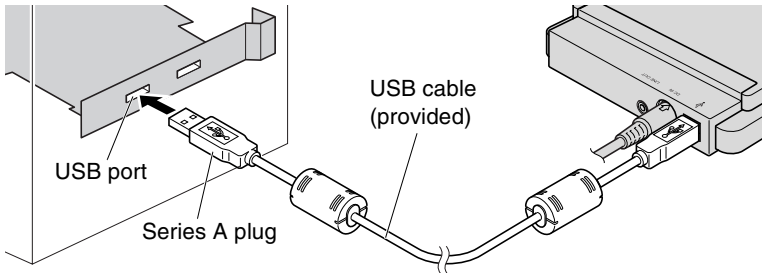

When the CRW-70 drive and computer are connected, the busy LED flashes green and then lights up orange and “PC” shows on the display.



Notes

- Be sure to connect the drive to the USB port of the computer. If you connect the drive to the computer via a USB hub, the drive may not operate properly.
- If the CRW-70 drive is connected to a USB 1.1 port, which is one of the typical USB ports installed as standard on computers, the drive operates in accordance with USB 1.1 standard. (→P. 10)

STEP 2 Install the Device Drivers

As soon as the CRW-70 drive is connected to the computer, it automatically starts installing the device drivers. The device drivers only need to be installed once when the CRW-70 drive is connected to the computer for the first time.

For Windows 98 Second Edition

Install the device driver provided.

For details, refer to the separate manual, “Device Driver Installation Guide,” that came with the CRW-70 drive.

For Windows Me/2000 Professional/XP

Windows Me, 2000 Professional or XP automatically installs the standard device drivers.

Note

The device driver needs to be installed for each USB port. If you connect the CRW-70 drive to a USB port for which the device driver has not yet been installed, a message will appear prompting you to install the device driver again.

STEP 3 Make Sure that the CRW-70 Drive Is Correctly Recognized

After connecting the CRW-70 drive to your computer, check to be sure that the drive is correctly recognized by the operating system.

For Windows 98 Second Edition/Me

Click **Start** on the taskbar, select **Setting, Control Panel** and **System**, and click the **Device Manager** tab to open the **Device Manager** window.

Note

For Windows Me, if the **System** icon is not found in the **Control Panel** window, click “view all Control Panel options” on the left side of the window.

Screen 1

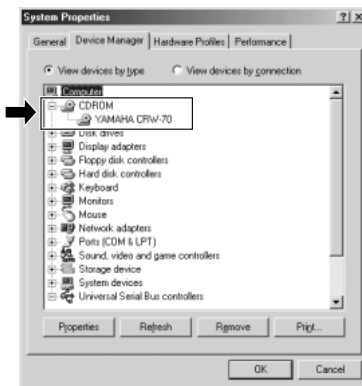

Screen 2 (Scroll down the list)

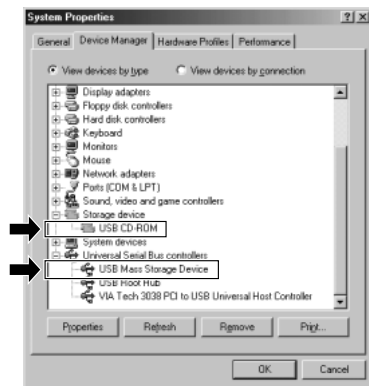

** These screens are examples on Windows Me.*

Make sure that “YAMAHA CRW-70” (Screen 1), “USB CD-ROM,” and “USB Mass Storage Device” (Screen 2) are displayed as shown above.

For Windows 2000 Professional

Click **Start** on the taskbar, select **Setting, Control Panel** and **System**, and click the **Hardware** tab and **Device Manager** to open the **Device Manager** window.

Make sure that “YAMAHA CRW-70 USB Device” is displayed under “DVD/CD-ROM drives,” and “USB Mass Storage Device” under “Universal Serial Bus controllers.”

For Windows XP

Click **start** on the taskbar, and select **Control Panel** and **System**, and click the **Hardware** tab and **Device Manager** to open the **Device Manager** window.

Note

If the **System** icon is not displayed in the **Control Panel** window, click “Switch to Classic View” on the left side of the window.

Make sure that “YAMAHA CRW-70 USB Device” is displayed under “DVD/CD-ROM drives,” and “USB Mass Storage Device” under “Universal Serial Bus controllers.”

Notes

- If these icons are not displayed or if **✖** or **ⓘ** is displayed on the left side of the icons, the devices are not correctly recognized by your computer. In that case, read the instructions on page 18 onwards carefully and check whether the CRW-70 drive is connected correctly.
- In some system environments, a green **?** mark may be placed on the left side of the icon for the above check items. This does not cause any hindrance to the operation of your drive.
- For details about how to use the operating system, refer to the documentation that came with it.

STEP 4 Install the CD Writing Software

Install the CD writing software that came with the CRW-70 drive. For details about how to install and use the software, refer to the documentation that came with it.

Disconnecting the CRW-70 Drive

The CRW-70 drive can be connected to or disconnected from your computer even when the computer is turned on (hot plug).

When removing the CRW-70 drive with the computer turned on, or when turning off the drive with the computer connected, follow the steps below.

- 1 Exit the CD writing software, if it is running.**
- 2 Be sure to remove the disc from the drive, if a disc is loaded.**
- 3 With Windows 98 Second Edition, you can disconnect the drive. With Windows Me/2000 Professional or Windows XP, start “Unplug or Eject Hardware” or “Safety Remove Hardware” on the taskbar, respectively, and then perform the necessary steps to disconnect the drive.**



** This screen is an example on Windows Me.*

Note

When writing, be sure not to disconnect the USB cable from the CRW-70 drive, or to disconnect or connect any USB devices from/to the computer.

Listening to Audio CDs and MP3 Discs

You can play audio CDs or MP3 discs on the CRW-70 drive without connecting it to your computer.

CDs/MP3 Discs that Can Be Played on the CRW-70 Drive

The CRW-70 drive can play ordinary audio CDs and MP3 discs onto which MP3 files have been written.

MP3 discs

What are MP3 files?

MP3 (MPEG-1 Audio Layer 3) is the name of a standard for compressing audio data that can be handled by computers. Audio data compressed by MP3 is called an MP3 file. The special feature of MP3 is its high compression rate, which lets you compress one 12 cm audio CD (maximum 74 minutes running time/650 MB data capacity) into about 65 MB of data.

MP3 data that can be played

- Only MP3 discs created in ISO9660 levels 1 and 2 multiple sessions, Joliet, and Romeo formats can be played. MP3 discs created by the packet write method cannot be played.
- Only files with an MP3 file compression bit rate of 192 kbps or less or a fixed bit rate, and compression format MPEG 1/2, Layer 2/3, can be played.
- Up to 300 files can be recognized. The 301st and subsequent files are not recognized.
- MP3 files that can be played are MP3 format with an .MP3 or .mp3 extension.
- Up to 8 folder levels on a disc can be recognized. The 9th and subsequent levels are not recognized.

Creating MP3 files

To create an MP3 file, you need extra encoder (or conversion) software. By following the software procedure you can compress audio data from an audio CD into an MP3 file.

Playback sequence of MP3 files

The sequence in which MP3 files on an MP3 disc are played back is determined by the depth of the levels of folders and the names of the folders or MP3 files.

- Folders are numbered in the order of the depth of their level. Among folders at the same level, playback starts from the files in the folder with the smaller number.
- The playback sequence determined by the names of the folders or MP3 files corresponds to the order of the character code: numbers → upper case alphabet → lower case alphabet.

On an MP3 disc with the following structure, MP3 files are played in the sequence 1 ~ 10.

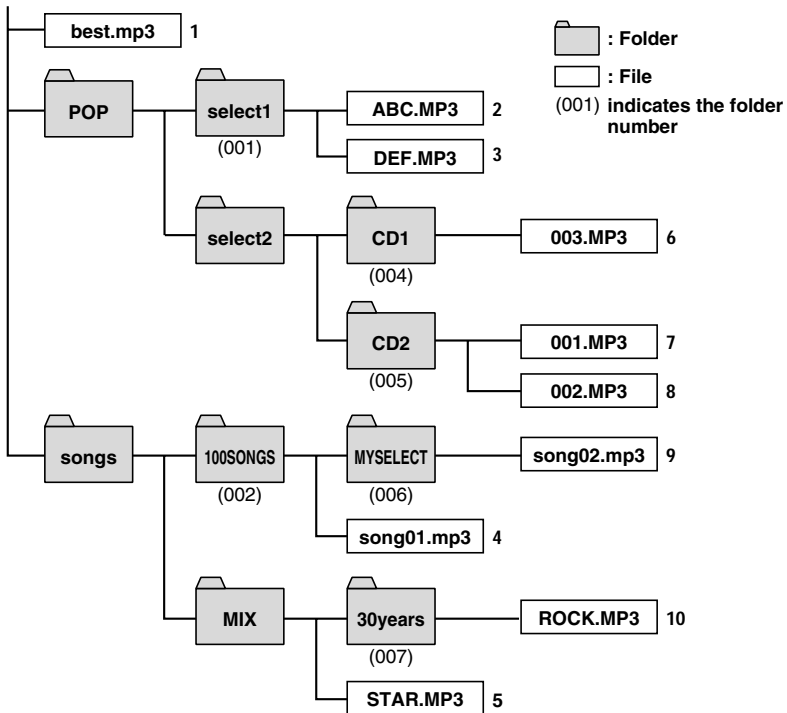

* The folder/file names are examples for your reference.

Note

It also depends on the system environment and the disc format in which the MP3 disc was created. In order to play back MP3 files in the sequence you want, YAMAHA recommend you place numbers at the beginning of the folder/file names.

Example: 001SONG.MP3, 002SONG.MP3, ...

Connecting

- 1 Connect headphones to the headphone jack or use the audio cable provided to connect an audio device to the LINE OUT jack.**

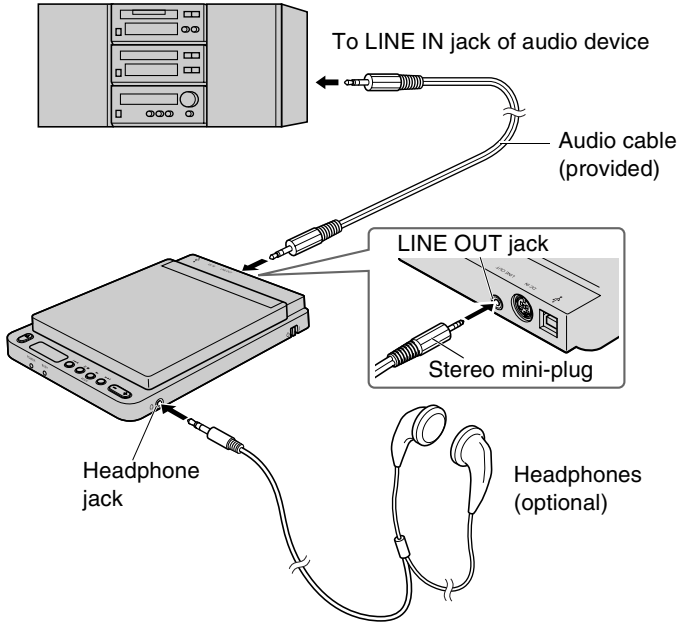

- 2 Check that the power switch of the CRW-70 drive is turned off (→P. 18) and then connect the AC adapter provided (→P. 19).**

Notes

- If the CRW-70 drive is directly connected to your computer, either disconnect the USB cable (→P. 24) or turn off the power switch of your computer.
- If you connect an audio cable to your audio device, either turn the device off or turn the volume right down before connecting.

Playback

1 Turn on the power switch of the CRW-70 drive. (→P. 20)

2 Load the disc. (→P. 15)

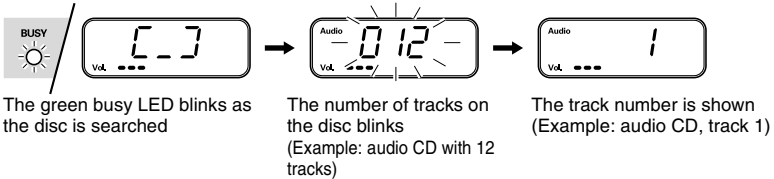

3 Press the play button.

The track shown on the display starts to play from the beginning.

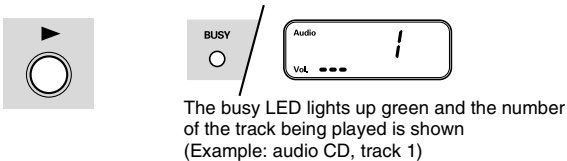

Note

If you try to play an MP3 file in a format not supported by the CRW-70 drive, the drive skips the track without playing the file.

Controlling the volume of the headphones

You can adjust the volume with the volume button. When it is pressed, the volume level is indicated on the display by a counter and a bar.



4 To stop playback, press the stop button twice.



Resume

The CRW-70 drive memorizes the track being played when playback is stopped. As long as the eject button is not pressed, the next playback starts from the same track, even if the power switch has been turned off and then back on.

5 Remove the disc as required. (→P. 16)

Pause During Playback

Pause

Press the pause button once.

The number of the track being played flashes.

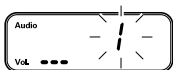

(Example: audio CD, track 1)

Releasing pause

Press the play button.

The track number stops flashing.

Skip

Skip forward

Press the skip FF button.

The disc skips to the beginning of the next track.

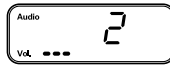

(Example: audio CD, track 2)

Skip back

Press the skip REW button.

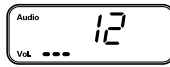

(Example: audio CD, track 12)

If you press this button while the disc is stopped, it skips back one track. If you press this button during playback, it skips back to the beginning of the track that is being played.

Track search

Press and hold down the skip FF button or skip REW button.

This skips through the tracks in succession.

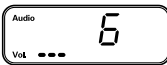

(Example: audio CD, track 6)

Folder search (on an MP3 disc)

If there is more than one folder containing MP3 files, a track search skips through the folders.



(Example: MP3 disc, folder 8)

Changing the Playback Mode

Press the mode button during playback.



The mode changes each time you press the button.

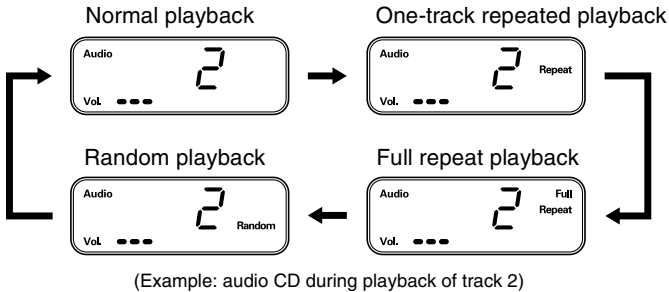

Normal playback

All the tracks on the disc are played in sequence. When the final track finishes, the disc stops.

One-track repeated playback

The same track is played back repeatedly.

Full repeat playback

After all the tracks on the disc are played in sequence, playback starts again from track 1.

Random playback

All the tracks on a disc (up to 300 tracks) are played once in random order. When each track has been played, the disc stops.

Troubleshooting

Please go to the YAMAHA CD-R/RW Drive web site for the latest support information, including troubleshooting information.

YAMAHA CD-R/RW Drive web site

URL: <http://www.yamaha.co.jp/english/product/computer/>

Europe

URL: <http://www.yamaha-it.de/>

The CRW-70 drive does not turn on.

● Are the AC adapter and the power cable connected correctly?

Make sure that the CRW-70 drive is correctly connected to the AC outlet, using the AC adapter and power cable provided. (→P. 19)

● Does the power LED of the CRW-70 drive light up orange if the power switch is turned on? (→P. 20)

If the power LED doesn't light up, consult your nearest Yamaha dealer (listed at the back of this manual).

The computer does not start up.

● Is the USB interface card installed correctly?

Refer to the documentation that came with your USB interface card.

The CRW-70 drive is not recognized by the operating system. (→P. 22)

● Is the CRW-70 drive correctly connected to the computer using the USB cable?

Turn off the computer and the CRW-70 drive and make sure that the USB cable is connected securely to both the computer and the drive. (→P. 18, 21)

● For Windows 98 Second Edition, have you installed the device driver provided?

Windows 98 Second Edition does not recognize the CRW-70 drive unless the device driver provided is installed. Install the device driver following the instructions of the separate manual, "Device Driver Installation Guide," that came with your drive.

- **Is the USB interface card correctly recognized by the operating system?**

Make sure that the USB interface card is correctly recognized by the operating system. (→P. 22)

If the USB interface is correctly recognized, consult your nearest Yamaha dealer (listed at the back of this manual).

If the USB interface is not correctly recognized, refer to the documentation that came with your computer or USB interface card. If the problem persists, it may be caused by the device driver. In this case, consult the manufacturer of your USB interface card or the user support service of your computer manufacturer.

The top cover does not open even when you press the eject button.

- **Is the CRW-70 drive turned on?**

See the troubleshooting item “The CRW-70 drive does not turn on.” (→P. 32)

- **Is any CD writing software being used?**

Some CD writing software locks the eject button while it is running on a computer. (If you are using such a software program, the top cover does not open even if the eject button is pressed.) In this case, perform the necessary steps in the software window to eject the disc, or exit the CD writing software before pressing the eject button.

- **Can the top cover be opened if the computer is restarted?**

Exit all running application software, restart your computer, and then press the eject button of the CRW-70 drive.

- **Can the top cover be opened if the USB cable is disconnected from the drive?**

Disconnect the USB cable from the drive while leaving the AC adapter connected to the drive, and press the eject button.

- Turn off the power switch of the CRW-70 drive and open the top cover by sliding the manual eject lever.

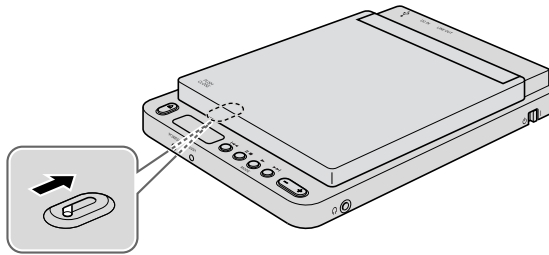

Note

Carrying out this operation excessively may damage your drive.

If the top cover still does not open, or if it cannot be opened with the eject button after being opened with the manual eject lever and then closed again, consult your nearest Yamaha dealer (listed at the back of this manual).

No data can be read from a disc.

- Are you sure the disc is of one of the types supported by the CRW-70 drive? (→P. 2, 45)

Before use, make sure that the disc is compatible with the CRW-70 drive.

- Is the disc dusty or dirty?

Remove dust or dirt from the disc, using an air spray or by wiping with a dry, soft cloth. To avoid damage, always wipe the disc gently in a direction perpendicular to the edge of the disc.

- Can data be read from other discs (audio CD, CD-ROM, etc.)?

If no data can be read from a specific disc, data may be written in a format that the drive cannot recognize, or the disc may be damaged or deformed. Note that no data can be read from blank discs, and also that the CRW-70 drive may sometimes fail to read data correctly from a disc even if the disc is compatible with the drive.

- **Does the busy LED light up correctly when a disc is loaded?**

When a disc is loaded, the busy LED flashes and then lights up green if the CRW-70 drive is connected to a computer, or flashes green and then goes off if the CRW-70 drive is being used as a CD/MP3 player.

(→P. 43)

If no data can be read from a specific disc, data may be written in a format that the drive cannot recognize, or the disc may be damaged or deformed.

If the busy LED lights up orange when the CRW-70 drive is connected to a computer, or the display monitor reads “— — —” (the disc is not recognized) when the CRW-70 drive is used as a CD/MP3 player, whatever type of disc is loaded, consult your nearest Yamaha dealer (listed at the back of this manual).

Button operation cannot be performed when the CRW-70 drive is being used as a CD/MP3 player.

- **Is the USB cable connected to the CRW-70 drive?**

Remove the USB cable connected to the computer or turn off the power switch of the computer. If the CRW-70 drive still does not work, consult your nearest Yamaha dealer (listed at the back of this manual).

The playback of an audio CD (CD-DA) or MP3 disc cannot be heard.

- **Check that the volume is not set to the minimum level.**
- **Check that all connections are secure, such as the headphones to the headphone jack of the CRW-70 drive or the audio device to the LINE OUT jack of the CRW-70 drive.**

- If you are using Windows Me and you cannot hear any playback sound from the CRW-70 drive via either headphones connected to its headphone jack or an audio device connected to its LINE OUT jack, check the following settings. (If Windows Media Player 7.0 is used in combination with Windows Me, this problem can arise since the digital playback option is activated by default.)

1 Setting “Properties” of the CRW-70 drive.

- ① Click **Start** on the taskbar, select **Setting, Control Panel, System**, the **Device Manager** tab, and **YAMAHA CRW-70 Properties**, and click the **Properties** tab.
- ② Uncheck the “Enable digital CD audio for this CD-ROM device” option.

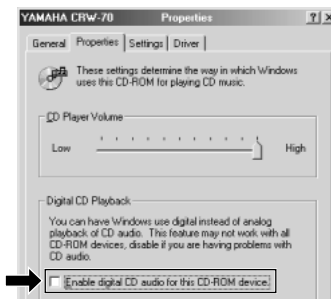

2 Setting Windows Media Player.

- ① Start “Windows Media Player.”
- ② Click **Tools** on the menubar, select **Options**, and click the **CD Audio** tab.
- ③ Uncheck the “Digital playback” option.

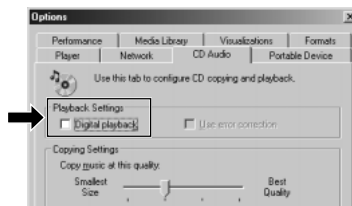

- If an MP3 disc cannot be played when the CRW-70 drive is being used as a CD/MP3 player, check the MP3 file and MP3 disc creation methods. (→P. 25)

The error message “Buffer Underrun” is displayed.

- **If your CD writing software supports Buffer Underrun Protection, you must activate it.**

For more details, refer to the documentation that came with your CD writing software. (The CD writing software that came with the CRW-70 drive supports Buffer Underrun Protection.)

- **To prevent the occurrence of a buffer underrun and to increase the efficiency of data writing, try the following:**
 - Reduce the data writing speed.
 - Create an image file on the hard drive.
 - Optimize the hard drive. (Defragmentation)
 - Do not start any application software (including screen savers) during data writing.
 - Deactivate the power management for the hard drive.
 - Select “DMA” for the data transfer mode of IDE devices such as hard drives or CD-ROM drives.
 - Deactivate the Windows Active Desktop.
 - Exit all memory-resident software programs.
 - Check your CD writing software against the documentation that came with it to be sure that there is no problem with it.

Notes

- When the CRW-70 drive is connected to a USB 1.1-compliant port on your computer, it operates in accordance with USB 1.1 standard. For CD writing software settings, it is advisable to activate Buffer Underrun Protection and to set the data writing speed to 8X. (→P. 10)
- A writing error can occur if vibration is applied to the drive while data is being written on the CD-R or CD-RW in it.

Unstable operation

- **Are two or more CD writing software programs installed on your computer?**

Installing two or more CD writing software programs on a computer sometimes makes its operation unstable. (The CD writing software programs that came with the CRW-70 drive can be used together without a problem.)

- **Is the disc dusty or dirty?**

Remove dust or dirt from the disc, using an air spray or by wiping with a dry, soft cloth. To avoid damage, always wipe the disc gently in a direction perpendicular to the edge of the disc.

Other problems

- **Your CD writing software does not recognize the CRW-70 drive.**

In order for CD writing software to recognize your drive, it must support the CRW-70 drive. Contact the manufacturer of your CD writing software to see whether the software supports the CRW-70 drive.

Recording Methods

Disc-at-Once (DAO)

This method is used to write all data onto a disc in one operation. This method writes multiple pieces of data successively without placing a space between them, starting with the innermost track of the disc. Once data is recorded by this method, no data can be added to the same disc even if there is enough space left on it. This method is very useful for making a backup copy of an entire CD.

Example: Ordinary CD-ROM



Example: Audio CD

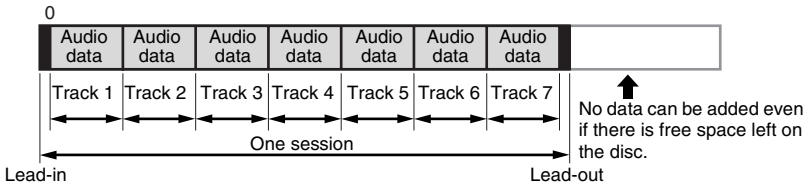

Lead-in and lead-out

These refer to signals written on a disc to indicate the start and end points of a session, respectively.

These signals are not included in the data, but are written in the same session as session management information. In other words, a session is made up of a lead-in, data, and a lead-out.

Track-at-Once (TAO)

This method is used to write data on a disc on a track-by-track basis. A track can be defined as the smallest unit of area that contains an ordinary program, pictorial data, text data, etc. This method allows you to add data to the same disc, one track of data at a time, as long as there is free space left on the disc. Discs that contain data recorded in several different sessions (writing of tracks) are referred to as multi-session discs.

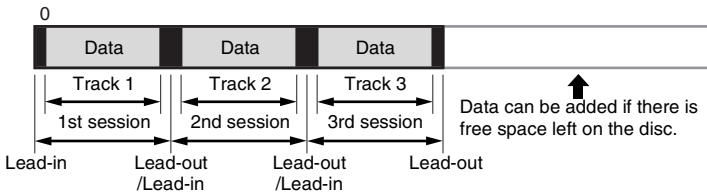

Note

Multi-session discs cannot be played on any ordinary audio CD player, except when data is recorded in a single session, or except for the first session.

Session-at-Once (SAO)

This method is used to write data on a disc on a session-by-session basis. Unlike Track-at-Once described above, Session-at-Once allows you to record multiple tracks onto a disc at one time. CD EXTRA, for example, uses this method to record multiple pieces of audio data (or multiple tracks) in the first session and information required for computers in the second session. This method allows you to add data to the same disc, one session at a time, as long as there is free space left on it. As is the case with discs containing data recorded by Track-at-Once method, discs containing data recorded by this method can also be called multi-session discs, provided that data is written in several different sessions.

Example: CD EXTRA

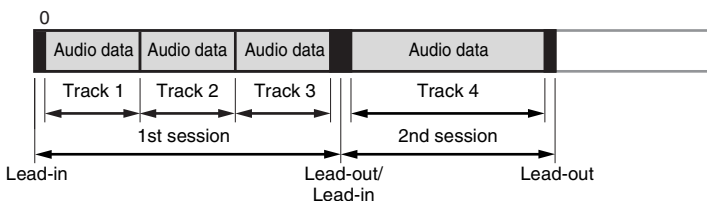

Packet Writing

This method is used to record data onto a disc on a file-by-file basis. This method divides a track into small segments called “packets” so that data can be written on a packet-by-packet basis, which means that you can record data in much the same way as you copy data to a floppy or hard drive by dragging and dropping it on your desktop. With such convenience, Packet Writing is suitable for daily data backup. Packet Writing also allows you to add packets to a disc as long as there is free space left on the disc.

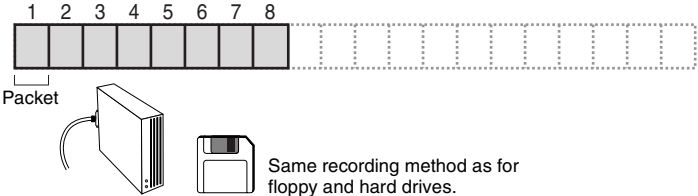

Notes

- Discs need to be formatted before use.
- Formatting a CD-RW, using packet writing software, reduces its storage capacity (rated capacity printed on the disc) by about 100 MB because disk space is required for packet writing itself.
- For CD-R discs, deleting data means masking data but not actually removing data. Therefore, deleting data from a CD-R does not increase free space on it.

Firmware

Firmware refers to the operating software designed for your CD-R/RW drive. It is stored in the drive's flash memory, so that it can be erased and rewritten. To enhance operation reliability, YAMAHA will continue improving the firmware and make updates available. You can find information about the latest firmware at the YAMAHA CD-R/RW Drive web site.

YAMAHA CD-R/RW Drive web site

URL: <http://www.yamaha.co.jp/english/product/computer/>

Europe

URL: <http://www.yamaha-it.de/>

The most up-to-date user support information, including information about the firmware, is available at the above YAMAHA CD-R/RW Drive web site. Go to the YAMAHA web site regularly to check this information.

Checking the firmware version of the CRW-70 drive

For Windows 98 Second Edition/Me

Click **Start** on the taskbar, select **Setting, Control Panel, System**, the **Device Manager** tab, and **YAMAHA CRW-70 Properties**, and click the **Settings** tab.

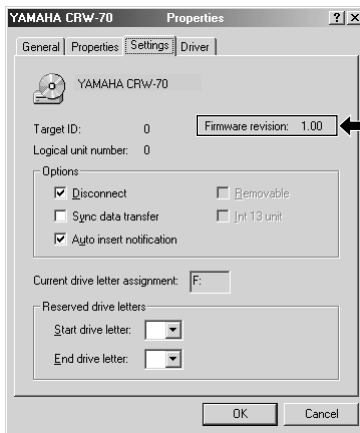

The revision number shown here varies depending on the firmware version of the drive.

** This screen is an example on Windows Me.*

For Windows 2000 Professional/XP

The firmware version cannot be displayed using Device Manager. Use your CD writing software to check the firmware version.

Relationship Between Busy LED and Operation

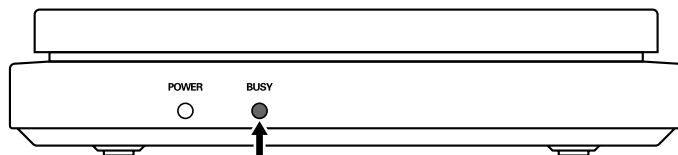

When used connected to a computer

Operating status	LED state	LED Color
Standby (with disc)	Lit	Green
Standby (without disc)	Lit	Orange
Top cover opened	Off	—
Reading of disc information (TOC)	Blinking	Green
Access for recording	Blinking	Orange
Writing (Test mode)	Blinking	Orange
Writing	Blinking	Orange
Reading	Blinking	Green
Playback	Blinking	Green

When used as a CD/MP3 player

Operating status	LED state	LED color
Standby	Off	—
Top cover opened	Off	—
Reading of disc information (TOC)	Blinking	Green
Playback	Lit	Green
Pause	Lit	Green
Skip (during playback or pause)	Lit	Green
Skip (during standby)	Off	—
Playback data error	Off	—

Relationship Between Display and Operation

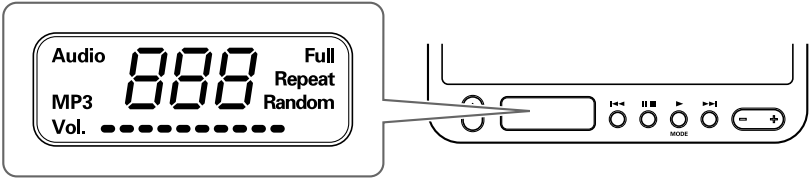

When used connected to a computer

Operating status	Message
Volume shown in 10 levels	Vol. ●●●●●●●●●●
Volume operation: Volume shown in 24 levels	02
Connected to computer	PC

When used as a CD/MP3 player

Operating status	Message
Audio CD playback	Audio
MP3 disc playback	MP3
Volume shown in 10 levels	Vol. ●●●●●●●●●●
One-track repeated playback	Repeat
Full repeat playback	Full Repeat
Random playback	Random
No disc loaded or incompatible disc load	---
Standby (disc confirmed)	[]
Playback: Currently playing track number displayed	2
Pause: Track number flashes	2
Track search: Track number displayed	2
Folder search: Folder number flashes	002
Volume operation: Volume shown in 24 levels	02

CRW-70 Drive Specifications

Supported Formats

	Write	Read	Play ^{*4}
CD-DA	●	●	●
CD TEXT	●	●	●
CD-ROM ^{*1}	●	●	●
Mixed Mode CD-ROM (CD-ROM+CD-DA)	●	●	●
CD-ROM XA ^{*1}	●	●	●
Photo CD ^{*1}	● ^{*2*}	●	●
Video CD	●	●	●
CD-i	●	● ^{*3}	—
CD EXTRA ^{*1}	●	●	●

^{*1} includes multisession

^{*2} suitable disc required

^{*3} suitable application software required

^{*4} suitable application software may be required depending on the format

Writing Methods

Disc-at-Once (DAO)
Session-at-Once (SAO)
Track-at-Once (TAO)
Packet Writing

Writing/Reading Speed

Writing	CD-R	1X, 2X, 4X, 8X (CLV), 12X (8X – 12X Partial CAV)
	CD-RW	2X, 4X, 8X (CLV), 4X – 10X Full CAV (Packet writing)
Reading	24X (max.) Full CAV	
	Note) • DATA: 24X (max.)	<ul style="list-style-type: none"> • CD-DA: 24X (max.) in audio extraction • CD-DA: 1X only in audio play • Video CD: 10X (max.) • Session closed disc: 24X (max.) • Session unclosed disc: 8X (max.)
CD-R	1X, 2X, 4X, 8X, 12X (8X – 12X Partial CAV) writing: CD-R discs specified in Orange Book Part 2, Ver. 3.1. Note) For 8X or faster writing, use a CD-R disc that matches the writing speed.	
CD-RW	2X or 4X writing: Orange Book Part 3, Vol.1, Version 2.0-compliant discs 4X, 8X, 4X – 10X Full CAV (Packet writing) writing: Orange Book Part 3, Vol.2, Version 1.0-compliant discs Note) For 2X writing, Book Part 3, Vol.1, Version 1.0-compliant discs can be used.	

Data Capacity	700 MB (with a 79-minute disc) 650 MB (with a 74-minute disc) 550 MB (with a 63-minute disc)
Data Transfer Rate (Mode 1)	1X: 150 KB/sec. 10X: 1,500 KB/sec. 2X: 300 KB/sec. 12X: 1,800 KB/sec. 4X: 600 KB/sec. 16X: 2,400 KB/sec. 8X: 1,200 KB/sec. 24X: 3,600 KB/sec.
Data Buffer Size	8 MB (3,224 sectors)
Average Access Time	200 msec. (random access)
Sector Size	2,048 – 2,352 bytes
Interface	USB 2.0/1.1
Burst Transfer Rate	USB 2.0 (High speed mode) : 480 MB/sec. (max) USB 1.1 (Full speed mode) : 12 MB/sec. (max)
Installing Style	Horizontal
Disc Loading Type	Top cover
Disc Clamp Mechanism	Self chucking
Audio Out	Line Out • Frequency range: 20 – 20,000 Hz • Output level : 700 mVrms
Power Consumption	10.0 W (when writing or reading) 0.8 W (standby)
Operating Environment	Temperature: 5 – 35 °C Humidity : 25 – 80% RH (no condensation)
Dimensions (includes projection)	Width : 136.0 mm Height : 29.5 mm Depth : 184.0 mm
Weight (not including accessories)	560 g

AC adapter (AD-301205)

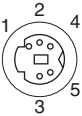
Rated Input Voltage	100 – 240 V AC
Rated Input Current	1.0 A or less
Rated Output Voltage	+5 V, +12 V DC
Rated Output Current	1.5 A
Terminal Output Polarity	 <ul style="list-style-type: none"> 1: +12 V DC 2: GND 3: +5 V DC 4: GND 5: +5 V DC
Operating Environment	Temperature: 5 – 35 °C Humidity : 25 – 80% RH (no condensation)
Dimensions (includes projection)	Width : 79.5 mm Height: 32.0 mm Depth : 147.0 mm
Weight (includes the power cable)	430 g (approx.)

Safety/EMC compliance

The CRW-70 drive complies with the following specifications.

Country/ Region	Compliance Specifications			Details
	Category	Item	Standards	
USA	Safety	Electrical	UL60950	Information Technology Equipment
		Laser	21CFR1040.10 FDA Chapter 1, Subchapter J	Class I Laser Equipment
	EMC/EMI	Emission	47CFR15 FCC Part 15, Subpart B	Class B Computing Device
Canada	Safety	Electrical	CSA C22.2 No. 60950	Information Technology Equipment
	EMC/EMI	Emission	ICES-003	Class B Computing Device
EU	Safety	Electrical	EN60950	Information Technology Equipment
		Laser	EN60825	Class 1 Laser Product
	EMC/EMI	Immunity	EN55024	Residential, Commercial and Light Industrial Areas
		Emission	EN55022	Class B Equipment
Australia New Zealand	EMC/EMI	Emission	AS/NZ 3548	Class B Equipment
Taiwan	EMC/EMI	Emission	CNS13438	Class B Equipment
Japan	EMC/EMI	Emission	VCCI	Class B Equipment

Index

A

- Audio CD 3
- Audio display 14

B

- Buffer Underrun Protection 7
- BUSY LED 12, 43

C

- CD EXTRA 3
- CD/MP3 player
 - CD/MP3 discs that can be played 25
 - Connecting 27
 - Controlling the volume of the headphones 28
 - MP3
 - Creating MP3 files 25
 - MP3 data that can be played... 25
 - MP3 discs 25
 - MP3 files 25
 - Playback sequence of MP3 files 26
 - Pause during Playback
 - Pause 29
 - Releasing pause 29
 - Playback 28
 - Playback mode
 - Changing the playback mode 31
 - Full repeat playback 31
 - Normal playback 31
 - One-track repeated playback .. 31
 - Random playback 31
 - Resume 29

Skip

- Folder search (on an MP3 disc)30
- Skip back30
- Skip forward30
- Track search.....30
- Stop playback29
- CD-R discs.....2
- CD-ROM3
- CD-RW discs2
- Connecting
 - as a CD/MP3 player.....27
 - as a CD-R/RW Drive.....17
- Counter14

D

- DC IN connector13
- Disc-at-Once (DAO)39
- Disconnecting24
- Display 12, 14, 44

E

- Eject button12

F

- Firmware42
- Forcibly opening the top cover34

H

- Headphone jack12
- High Speed CD-RW discs2

I

- Image files11

L

- Lead-in39
- Lead-out39
- LINE OUT jack13
- Loading a disc15

M

Manual eject lever	13
MP3 display	14

O

Orange Book	3
-------------------	---

P

Packet Writing.....	41
Partial CAV.....	4
Pause/stop button	12
Play/mode button	12
Playback mode	14
POWER LED.....	12
Power switch	12

R

Recording methods.....	39
Removing a disc.....	16

S

Serial number	11
Session-at-Once (SAO).....	40
Skip FF button.....	12
Skip REW button	12
Supported discs	2
Supported formats	45
System requirements	9

T

Test-writing	8
Top cover	12
Track-at-Once (TAO)	40
Troubleshooting	
Buffer Underrun Error	37
Button operation cannot be performed.....	35
No data can be read from a disc....	34
The computer does not start up....	32
The CRW-70 drive does not turn on.....	32
The CRW-70 drive is not recognized by the operating system	32
The playback cannot be heard.....	35
The top cover does not open	33
Unstable operation	38
Your CD writing software does not recognize the CRW-70 drive	38

U

USB

USB cable	10
USB interface card.....	9
USB port	13

V

Volume button	12
Volume indicator	14

Distributors and Head Offices / Vertriebs- und Hauptgeschäftsstelle Distributeurs et sièges sociaux / Distribuidores y Casas matrices

If you have any questions, please contact your dealer or one of the following companies.

Bei weiteren Fragen wenden Sie sich bitte an Ihren Händler oder eine der folgenden Firmen.

Pour plus de détails sur les produits, veuillez vous adresser à Yamaha ou au distributeur le plus proche figurant dans la liste suivante :

Si tiene alguna pregunta, por favor póngase en contacto con su distribuidor o una de las siguientes empresas:

EUROPE, EASTERN EUROPE and RUSSIA

Yamaha Elektronik Europa GmbH
IT-Sales Division
Siemensstrasse 22-34,
D-25462 Rellingen, GERMANY
URL: <http://www.yamaha-it.de/>

TEL: +80092624222

(AUSTRIA, BELGIUM, DENMARK, FINLAND,
FRANCE, GERMANY, HUNGARY, ICELAND,
IRELAND, ITALY, LUXEMBOURG,
NETHERLANDS, NORWAY, PORTUGAL, SPAIN,
SWEDEN, SWITZERLAND, UNITED KINGDOM)

TEL: +80093067
(MONACO)

If you are calling from outside the countries mentioned
above, or if you can't get through on the Yamaha toll-
free number, use the following number instead:

TEL: +3214400793

U.S.A.

Yamaha Electronics Corporation, USA
6660 Orangethorpe Avenue,
Buena Park, CA 90620, U.S.A.
TEL: +1 714 522 9105
FAX: +1 714 670 0108
URL: <http://www.yamaha.com/>

CANADA

Yamaha Canada Music Ltd.
135 Milner Avenue, Scarborough,
Ontario M1S 3R1, CANADA
TEL: +1 416 298 5664
FAX: +1 416 292 0732
URL: <http://www.yamaha.ca/>

AUSTRALIA

Yamaha Music Australia Pty., Ltd.
Level 1, 99 Queensbridge Street
Southbank, Victoria 3006
AUSTRALIA
TEL: +61 3 9693 5111
FAX: +61 3 9699 2332

SINGAPORE, MALAYSIA, THAILAND, PHILIPPINES, INDIA, VIETNAM, CAMBODIA, MYANMAR, INDONESIA and IRAN

Yamaha Electronics Asia Pte Ltd.
138 Cecil Street
#05-02/03 Cecil Court, Singapore 069538 SINGAPORE
TEL: +65 223 3992
FAX: +65 223 9810

TAIWAN

Yamaha KHS Music Co., Ltd.
11F, No.150, Tun Hua North Rd.
Taipei, TAIWAN R.O.C.
TEL: +886 2 2713 8999
FAX: +886 2 2713 8666
URL: <http://www.yamahakhs.com/>

JAPAN

Yamaha Corporation
AV & IT Business Group
IT Sales & Marketing Division
203 Matsunokijima, Toyooka-mura, Iwata-gun,
Shizuoka-ken 438-0192, JAPAN
TEL: +81 539 62 6558
FAX: +81 539 62 5346
URL: <http://www.yamaha.co.jp/english/>



COMPACT
disc
ReWritable High Speed

YAMAHA CORPORATION
X2271A0 CRW-70(W)
Printed in China