

Quick start guide

for models CS6128-31/CS6129/
CS6129-2/CS6129-3/CS6129-4/
CS6129-31/CS6129-32/CS6129-41/
CS6129-52/CS6129-54

Install the telephone base and charger(s)

Install the telephone base and charger(s) as shown below.

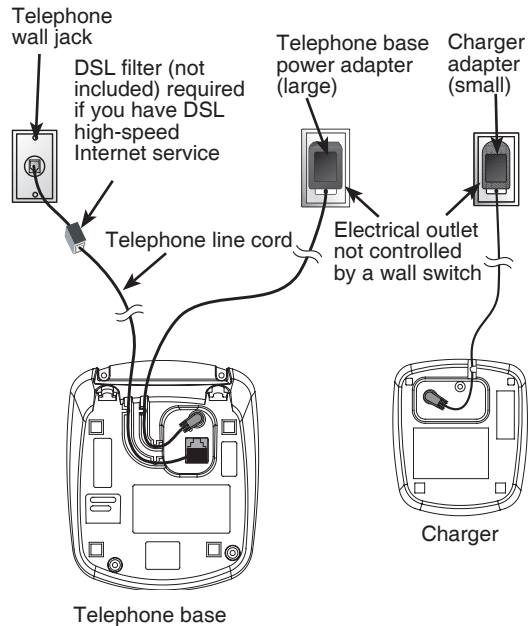

NOTES:

1. Use only the power adapter(s) and battery(ies) supplied with your VTech telephone.
2. For complete feature instructions, please refer to your user's manual.

Battery installation and charging

Install the battery as shown below. After installing the battery, you might be able to make and receive short calls. For best performance, charge the handset battery for at least 16 hours before use.

- ① If the battery compartment cover is on the handset, press the indentation and slide the cover to remove.
- ② Plug the battery securely into the plug inside the handset battery compartment, matching the color-coded label.

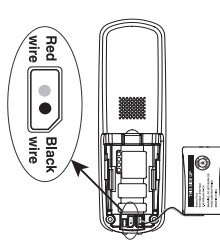
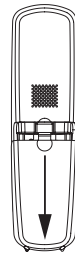

- ③ Place the battery with the label **THIS SIDE UP** facing up and the wires inside the battery compartment.
- ④ Align the cover flat against the battery compartment, then slide it upwards until it clicks into place.

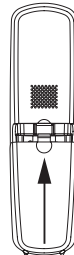
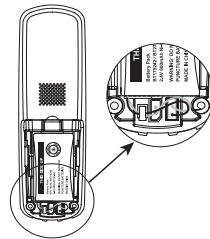

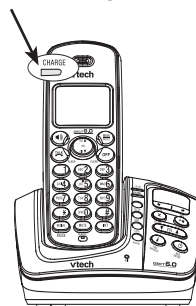

- ⑤ Charge the handset by placing it in the telephone base or charger. The **CHARGE** light will be on when the handset is charging.

CHARGE light



Make, answer and end a call

Make a call

1. Press **TALK/FLASH** or .
 2. Dial the number.
- OR-
1. Dial the number.
 2. Press **TALK/FLASH** or .

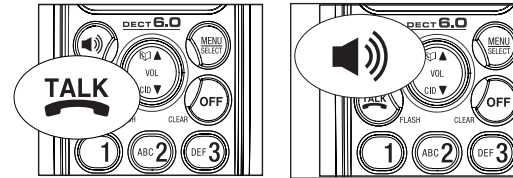

Answer a call

- Press **TALK/FLASH**,  or any of the dialing keys (0-9, #, *).

End a call

- Press **OFF/CLEAR** or put the handset in the telephone base or charger.

Activate the answering system

The answering system must be turned on to answer and record messages. Press **ANS ON/OFF** to turn the answering system on or off. When the answering system is turned on, it will announce "Calls will be answered," and the **ANS ON/OFF** light will be on. When the answering system is turned off, it will announce "Calls will not be answered," and the **ANS ON/OFF** light will be off.

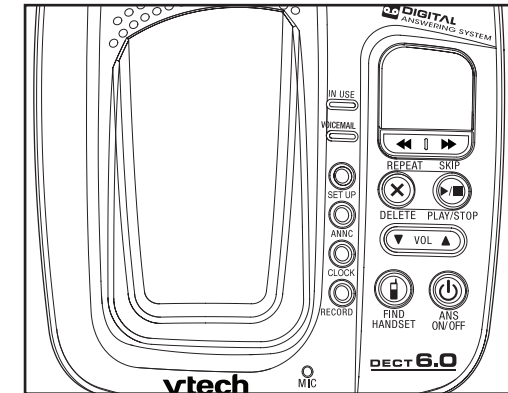

Outgoing announcement

The telephone is preset with a greeting that answers calls with "Hello, please leave a message after the tone." You can use this preset announcement, or replace it with your own.

To record your own announcement:

1. Press **ANNC** while the telephone is not in use and the system will announce "Announcement. Press **PLAY** or press **RECORD**."
2. Press **RECORD** and the system announces, "Record after the tone. Press **STOP** when you are done."
3. After the tone, speak towards the microphone at the bottom front of the telephone base from about nine inches away.
4. Press **▶/PLAY/STOP** when finished.
5. The answering system will automatically play the newly recorded announcement. Press **▶/PLAY/STOP** to stop the playback at anytime.

To play messages:

- Press **▶/PLAY/STOP** to play messages and stop playback.
- Press **X/DELETE** while a message is playing to delete it.
- Press **▶/SKIP** to skip to the next message.
- Press **◀/REPEAT** to repeat the current message.
- Press **VOL ▲/▼** to raise or lower playback volume.

IMPORTANT!

If your product is not working properly:

- Refer to the **Troubleshooting** section of the user's manual.
- Visit our website at www.vtechphones.com or call 1 (800) 595-9511. In Canada, go to www.vtechcanada.com or dial 1 (800) 267-7377.