



**Monogram®**

## ZIFI240PII – GE Monogram Fresh-Food Refrigerator Module (Custom panel required)

## ZIFS240PSS – GE Monogram Fresh-Food Refrigerator Module (Stainless steel)

### Dimensions and Specifications (in inches)

#### Installation Space

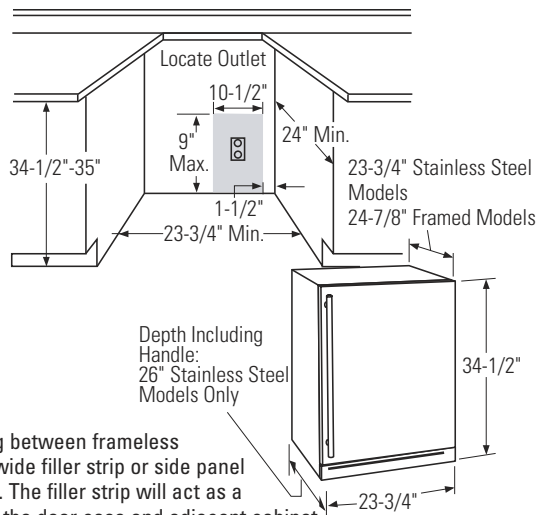

**Note:** If installing between frameless cabinets, a 1/2" wide filler strip or side panel may be required. The filler strip will act as a spacer between the door case and adjacent cabinet and will prevent interference with cabinet door swing. The width of the opening must include filler panels.

#### The cutout depth must be 24"

The cutout dimensions shown allow for a full door swing and access to the pull-out racks when installed as a built-in.

- The Fresh-Food Refrigerator can be free-standing.
- The stainless steel model ZIFS240PSS can be installed flush with standard cabinetry. ZIFI240PII with custom panel will project forward 1-3/4" of adjacent 24" deep base cabinets.
- **Note:** Door swing is not reversible.

#### Additional Specifications:

- A 120 volt 60Hz., 15 or 20 amp power supply is required. An individual property grounded branch circuit or circuit breaker is recommended. Install a properly grounded 3-prong electrical receptacle recessed into the back wall as shown. Electrical must be located on rear wall as shown. **Note:** GFI (ground fault interrupter) is not recommended.

### Product Clearances

#### Models with a Custom Door Panel

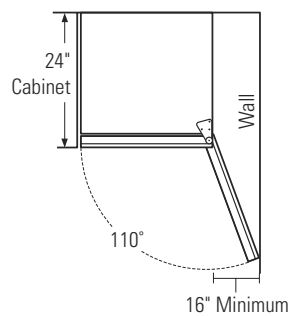

#### Stainless Steel Models

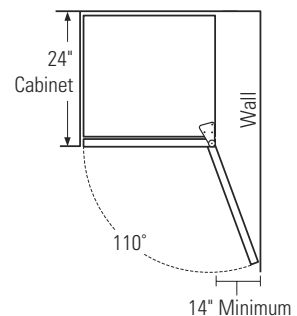

All models are factory set for a 110° door swing.

#### For a minimum 90° door swing:

- Allow 4" min. clearance to wall on the hinge side for Stainless Steel models.
- Allow 4-1/2" min. clearance to wall on the hinge side for models with a custom panel and custom handle.

#### For a full 110° door swing:

- Allow 14" min. clearance to wall on the hinge side for Stainless Steel models.
- Allow 16" min. clearance to wall on the hinge side for models with a custom panel and custom handle.



Listed by  
Underwriters  
Laboratories

For answers to your Monogram®, GE Profile™ or GE® appliance questions, visit our website at [GEAppliances.com](http://GEAppliances.com) or call GE Answer Center® service, 800.626.2000.



Monogram®

## ZIF1240PII – GE Monogram Fresh-Food Refrigerator Module (Custom panel required)

## ZIFS240PSS – GE Monogram Fresh-Food Refrigerator Module (Stainless steel)

### Dimensions and Specifications (in inches)

For a complete food storage center, install two Monogram refrigeration modules side-by-side.

**Note:** Reversible door swing on wine chillers/reserves and beverage centers only. See below for combination cutout dimensions.

**Important Note:** Products must operate from separate, properly grounded receptacles.

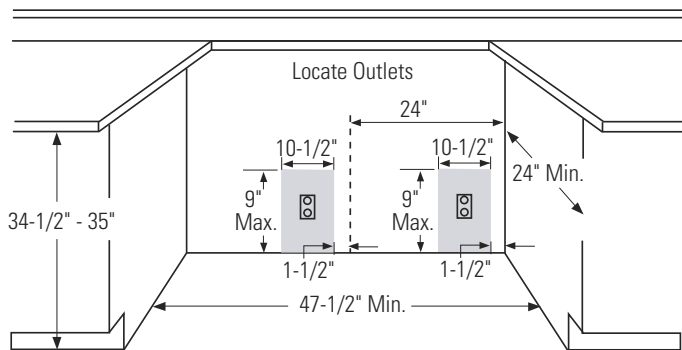

**Note:** Additional cutout width may be required for models with custom panels.

### Grounding the Fresh-Food Refrigerator

IMPORTANT – (Please read carefully)

FOR PERSONAL SAFETY, THIS APPLIANCE MUST BE PROPERLY GROUNDED.

The power cord of this appliance is equipped with a 3-prong (grounding) plug which mates with a standard 3-prong (grounding) wall receptacle to minimize the possibility of electric shock hazard from this appliance.

Have the wall outlet and circuit checked by a qualified electrician to make sure the outlet is properly grounded.

When a standard 2-prong wall outlet is encountered, it is your personal responsibility and obligation to have it replaced with a properly grounded 3-prong wall out.

DO NOT, UNDER ANY CIRCUMSTANCES, CUT OR REMOVE THE THIRD (GROUND) PRONG FROM THE POWER CORD.

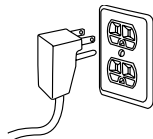

DO NOT USE AN ADAPTER PLUG TO CONNECT THE REFRIGERATOR TO A 2-PRONG OUTLET.

DO NOT USE AN EXTENSION CORD WITH THIS APPLIANCE.

**Specification Revised 7/05**

120032

### 3/4" Overlay Panel Dimensions

Model ZIF1240PII requires customer-provided overlay door panel.

- The overlay panel must be secured to a 1/4" thick backer panel which slides into the trim. A .10" thick spacer panel must be placed between the custom and backer panel.
- A custom handle of your choice, supplied by your cabinet maker, must be installed on the overlay panel.

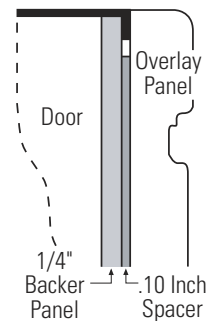

Use a 3/4" router bit to cut a notch into the **back** side of the assembled panel to allow for hinge clearance.

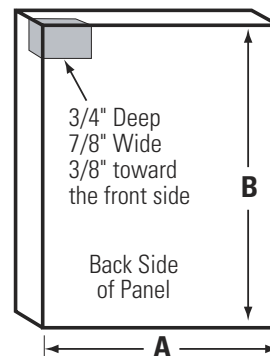

### 3/4" Overlay Panel Dimensions (in inches)

	A (Width)	B (Height)
1/4" Backer	23-3/16"	29-9/16"
0.10" Spacer	22-1/2"	29-1/16"
3/4" Overlay	23-5/8"	30"

NOTE: Max. assembled drawer panel weight is 25 lbs.

Assemble overlay panels with glue and screws.

- Center spacer panel on the backer panel, left to right and top to bottom. Secure the panels with glue.
- Center the spacer/backer panel on the overlay panel. Secure with glue and screws. Countersink screws into the backer panel.

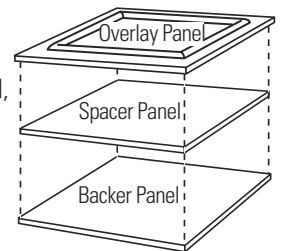

Listed by  
Underwriters  
Laboratories

For answers to your Monogram® GE Profile™ or GE® appliance questions, visit our website at [GEAppliances.com](http://GEAppliances.com) or call GE Answer Center® service, 800.626.2000.



**Monogram®**

**ZIFI240PII – GE Monogram Fresh-Food Refrigerator Module  
(Custom panel required)**

**ZIFS240PSS – GE Monogram Fresh-Food Refrigerator Module  
(Stainless steel)**

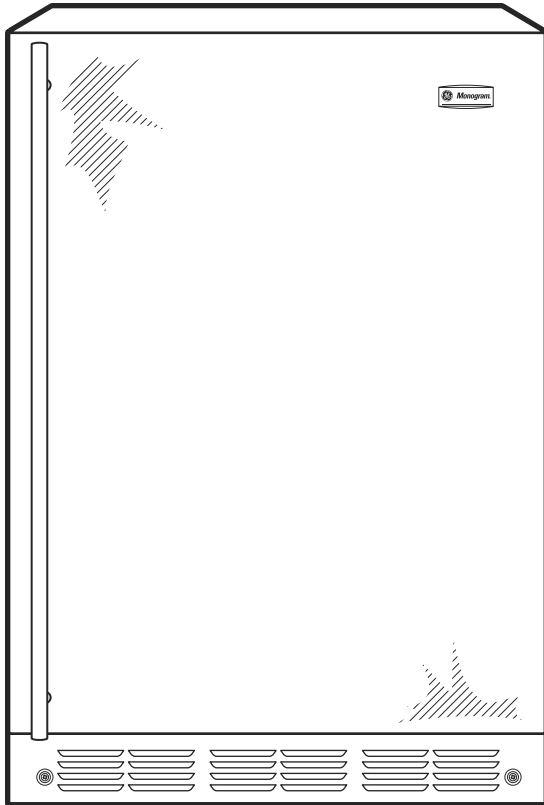

**Features and Benefits**

- Electronic adjustable temperature control – Offers a range of temperatures for precise chilling
- LED temperature display – Allows you to monitor the temperature at a glance
- Clear LEXAN® crisper on full-extension slides – Provides easy access to contents
- Removable spillproof glass shelves – Helps contain spills for ease of cleaning
- QuickSpace™ Shelf – Quickly slides out of the way to make room for tall items
- Custom panel and handle required – Customer must install a custom door panel and handle to complement their décor (ZIFI240PII only)
- Model ZIFS240PSS – Stainless steel
- Model ZIFS240PLSS – Stainless steel, left hinge
- Model ZIFI240PII – Custom panel and handle required
- Model ZIFI240PLII – Custom panel and handle required, left hinge

**Specification Revised 7/05**

120032