



Keeping Business in Business

POWERSURE™ PERSONAL

300-500 VA
115V

USER MANUAL

English



IMPORTANT SAFETY INSTRUCTIONS

SAVE THESE INSTRUCTIONS

This manual contains important safety instructions that should be followed during the installation and maintenance of the UPS. Please read this manual thoroughly before attempting to install or operate this UPS.

WARNING:

- To prevent the risk of fire or electric shock, install the UPS in a temperature and humidity controlled room, free of conductive contaminants.
- Operate the UPS only from a properly grounded AC supply.
- To reduce the risk of electric shock, do not remove the cover, as it has no user-serviceable parts inside. Some components are live, even when AC power is disconnected. For service, contact a qualified technician.
- To reduce the risk of fire, use the proper rating when replacing the fuse.

CAUTION:

Although your UPS has been designed and manufactured to assure personal safety, improper use can result in electrical shock or fire. To insure safety, please observe the following rules:

- Turn off and unplug your UPS before cleaning. Do not use liquid or aerosol cleaners. A dry cloth is recommended to remove dust from the surface of your UPS.
- Do not install or operate your UPS in or near water.
- Do not place UPS on an unstable cart, stand, or table.
- Do not place UPS under direct sunlight or close to heat emitting sources.
- Do not place UPS power cord in any area where it may get damaged by heavy objects.
- Follow all warnings and instructions marked on the UPS. Do not attempt to service the UPS, as it has no user-serviceable parts inside. Refer all repairs to qualified service personnel.

ATTENTION:

Turn off and unplug your UPS from the outlet and contact qualified service personnel if:

- The power cord or plug is damaged.
- Liquid has been spilled on the UPS.
- The fuse blows frequently.
- The UPS does not operate even when user follows the operating instructions.

CONDITIONS OF USE: The input receptacle must be within 6 feet (1.8 meters) of the UPS.

Your UPS provides conditioned power to connected equipment. Maximum load must not exceed that shown on UPS rating label. If uncertain, consult your distributor or Liebert.

Placing magnetic storage media on top of the UPS may result in data corruption.

This equipment can be operated by individuals without previous training.

INTRODUCTION & SYSTEM DESCRIPTION

Congratulations on your choice of the Liebert PowerSure Personal Uninterruptible Power System (UPS). It provides conditioned power to microcomputers and other sensitive electronic equipment.

NOTE: This equipment has been tested and found to comply with the limits for a Class B digital device, pursuant to part 15 of the FCC Rules. These limits are designed to provide reasonable protection against harmful interference in a residential installation. This equipment uses, generates and can radiate radio frequency energy and, if not installed and used in accordance with the instructions, may cause harmful interference with radio communications. However, there is no guarantee that interference will not occur in a particular installation. If this equipment does cause harmful interference to radio or television reception, which can be determined by turning the equipment off and on, the user is encouraged to try to correct the interference by one or more of the following measures:

- Reorient or relocate the receiving antenna.
- Increase the separation between the equipment and the receiver.
- Connect the equipment into an outlet on a circuit different from that which the receiver is connected.
- Consult the dealer or an experienced radio/TV technician for help.

MAJOR COMPONENTS

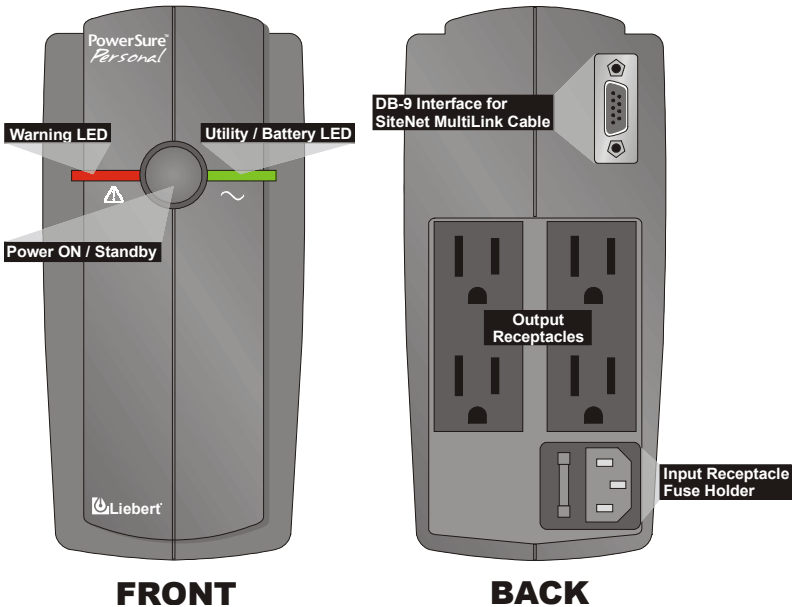

PowerSure™ Personal Line Diagram

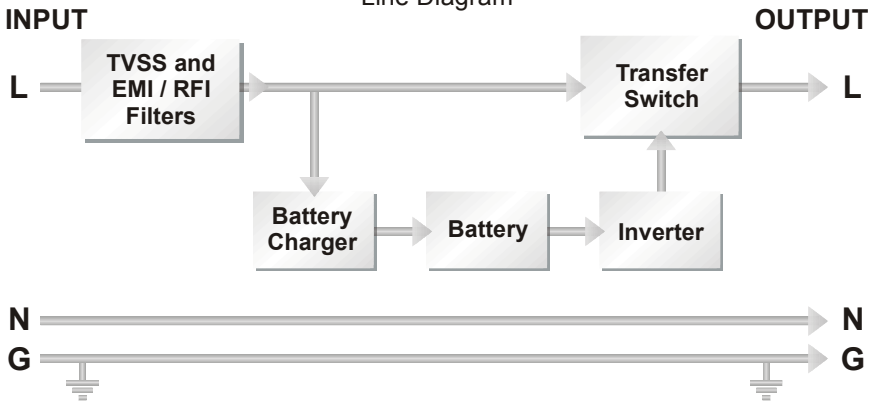

Normal Operation

During normal operation, incoming utility power is supplied to the load as shown above. The utility power passes through the EMI/ RFI filters and TVSS circuitry and then through the transfer switch to the connected loads. The battery charger is operational whenever AC power is supplied, even when the unit is switched off. PowerSure Personal continuously monitors the batteries.

Transfer Switch

In Normal mode the transfer switch passes utility AC power to the connected load. When input utility or frequency is outside acceptable limits, the transfer switch activates and transfers the UPS to battery.

Battery Charger

In normal operation, the battery charger converts utility AC power into regulated DC power to float charge the battery.

Battery

The PowerSure Personal utilizes valve regulated, nonspillable, lead acid battery. At typical room temperatures and with the UPS float charging, the battery system will last many years.

Transient Voltage Surge Suppression (TVSS) & EMI / RFI Filters

These UPS components provide surge protection and filter electromagnetic interference (EMI) and radio frequency interference (RFI). They minimize any surges or interference present in the utility line and keep the sensitive equipment protected.

GENERAL INSTALLATION

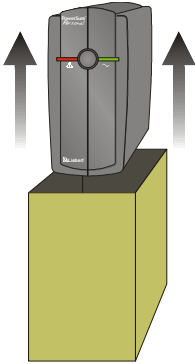

Remove from Box

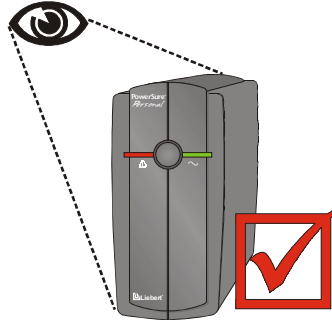

Check for Damage

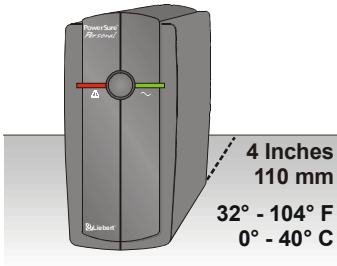

4 Inches
110 mm
32° - 104° F
0° - 40° C

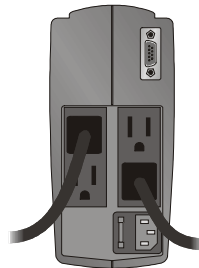

Plug in Loads

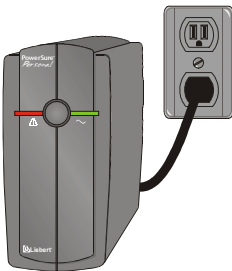

Plug UPS into AC

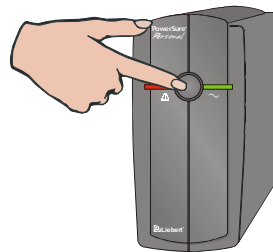

**Press ON Button
for 2 seconds**

MAINTENANCE

The PowerSure Personal UPS requires very little maintenance. The batteries are valve regulated, nonspillable, lead acid, and require that they be kept charged to obtain their designed life. The UPS continuously charges the batteries when connected to the utility supply.

When storing the UPS for any length of time, it is recommended to plug in the UPS for at least 24 hours every four to six months to ensure full recharge of the batteries.

FUSE REPLACEMENT PROCEDURES

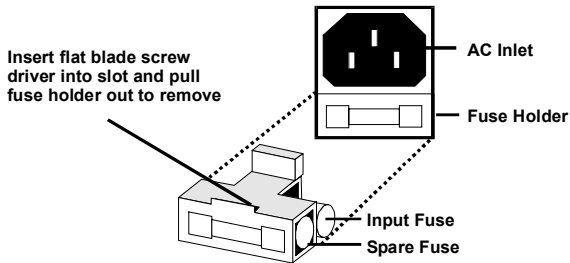

CAUTION: Before changing the supply fuse, turn off the UPS, and unplug the input cord from the AC input power supply and from the UPS.

1. Remove the fuse holder by inserting a flat blade screwdriver into the slot and pulling out as indicated in the figure above.
2. Remove the input fuse.
3. Remove the spare fuse from its position by using the screwdriver to push it out.
4. Place spare fuse in the input fuse position, and replace the fuse holder. The fuse holder will lock into position.
5. Reconnect the input power lead to the UPS, and the input power lead to the input AC supply.
6. Restart the UPS. The UPS is ready for normal operation.

Personal Model #	Fuse Type
PSP300-115	5A / 125V
PSP500-115	6A / 125V

COMMUNICATIONS

The PowerSure™ Personal UPS contains a standard DB-9 receptacle located on the rear of the UPS unit. Several signals are provided on this port and are assigned as follows:

PIN	ASSIGNMENT DESCRIPTION
1	Low Battery (open collector)
2	No connection
3	No connection
4	On Battery Mode Shutdown (5-12 DC)
5	On Battery Mode Shutdown Return
6	Utility Fail / Normally On (open collector)
7	Low Battery (open emitter)
8	Utility Fail (common) (pins 6 & 9)
9	Utility Fail / Normally Off (open collector)

Pin Assignment

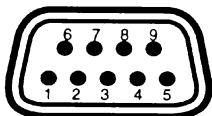

Collector to Emitter*

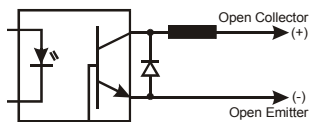

**Maximum voltage and current on pins 1, 6, 7, 8, 9 is 60V DC; 5.0 mA.*

TROUBLESHOOTING

If the UPS fails to operate properly, turn off the unit and repeat the steps in the installation section of this manual. If the problem persists, refer to the chart below:

PROBLEM	CAUSE	SOLUTION
UPS will not start	Overload/Short Circuit	Check fuse at rear of UPS. If blown, replace it and restart the UPS. For further help, call your Liebert representative
UPS starts on battery, but will not switch to AC	UPS not plugged in	Plug in power cord securely
	Fuse blown	Replace fuse and restart UPS
	Power not available at utility receptacle	Call a qualified electrician
	Input voltage below threshold	Wait until voltage rises to appropriate level Voltage must be higher than 90 VAC
	AC overvoltage	AC voltage must be less than 132 VAC
UPS shuts down	Overload/Short Circuit	Check the fuse holder at rear of UPS. If fuse is blown, replace it and restart the UPS. If problem persists, disconnect some of the equipment from your UPS - the total wattage of your equipment may exceed the capacity of the UPS. For further help, call your Liebert representative
	Low Battery	Turn OFF equipment and recharge UPS battery for at least 7 to 10 hours. If problem persists, contact your Liebert representative
	Sitenet 1 Shutdown	Consult the Sitenet 1 User Manual or contact your LAN administrator

LED & ALARM INDICATIONS

Startup

Mode	Green	Red	Alarm	Action
UPS Start	Flash 1-2 sec.	Flash 1-2 sec.	Beep 1-2 sec.	Press ON button for 2 seconds

AC Mode

Mode	Green	Red	Alarm	Indicates
AC Normal	ON	OFF	OFF	UPS is on-line
Check Battery	ON	Flash 10 sec. every 4 min.	Flash 10 sec. every 4 min.	Battery Fault
Overload	ON	Flash every 0.5 sec	2 Beeps every 0.5 sec	Reduce loads
UPS Fault	ON	ON	Continuous Beep	UPS Failure

Battery Mode

Mode	Green	Red	Alarm	Indicates
Back Up	Flash every 3 sec	OFF	Beep every 3 sec	UPS is on Battery
UPS Fault	Flash every 3 sec	ON	Continuous Beep	No Output
Low Battery Warning	Flash every 0.5 sec	OFF	Beep every 0.5 sec	UPS is about to shutdown
Low Battery Shutdown	Flash 5 sec	OFF	Beep 5 sec	UPS Shutdown
Overload Warning	Flash every 3 sec	Flash every 0.5 sec	2 Beeps every 0.5 sec	Reduce loads
Overload Shutdown	OFF	ON	Continuous Beep	Reduce loads & restart

Shutdown

Mode	Green	Red	Alarm	Action
UPS Shutdown	OFF	OFF	OFF	Press ON button for 2 seconds

115V SPECIFICATIONS

Model Number	PSP300-115	PSP500-115
Model Rating VA / W	300 / 180	500 / 300
DIMENSIONS: in (mm)		
Unit □H x W x D	7.0 x 3.0 x 9.4 (178 x 76 x 238)	7.0 x 3.0 x 9.4 (178 x 76 x 238)
Shipping □H x W x D	10.6 x 4.3 x 12.3 (270 x 110 x 312)	10.6 x 4.3 x 12.3 (270 x 110 x 312)
WEIGHT: lbs (kg)		
Unit	6.2 (2.8)	8.0 (3.6)
Shipping	7.7 (3.5)	9.5 (4.3)
INPUT AC PARAMETERS		
Voltage Range without Battery Operation	90-132 VAC	
Low Line Transfer	90 VAC	
High Line Transfer	132 VAC	
Frequency	45-55 Hz or 54-66 Hz; auto sensing	
Input Power Cord	6 ft. detachable, w/ NEMA 5-15 P	
OUTPUT AC PARAMETERS		
Output Receptacles	(4) 5-15R	
Voltage (Battery Mode)	115 VAC ± 5%	
Output Current	2.6 A	4.3 A
Waveform (Battery Mode)	Stepped Sinewave	
Frequency	50 Hz or 60 Hz; auto sensing	
Overload Warning (Utility and Battery Modes)	101 – 120%	
Overload Shutdown (Utility and Battery Modes)	Overload Warning + (15 – 25 W)	Overload Warning + (20 – 45 W)
BATTERY PARAMETERS		
Type	Valve-regulated, nonspillable, lead acid	
Quantity x Voltage x Rating	(1) x 12V x 4.5 Ah	(1) x 12V x 7.0 Ah
Approved Battery Manufacturers:	CSB, Panasonic, BB Battery, and Yuasa	
Transfer Time	2 – 6 ms typical	
Back-up Time:	At 77°F (25°C), resistive loading, with fully charged batteries:	
Full load	> 4 minutes	
Half load	12 minutes	
Recharge Time	7-10 hours to 90% capacity, after full discharge into 100% resistive load	
ENVIRONMENTAL		
Operating Temperature	+32° F to + 104° F (0° C to +40° C)	
Storage Temperature	+5° F to + 122° F (-15° C to +50° C)	
Relative Humidity	0% to 90%, non-condensing	
Operating Elevation	Up to 10,000 ft. (3000 m) at 95° F (35° C) without derating	
Audible Noise	< 40 dBA, at 1 meter	
AGENCY		
Safety	UL 1778, c-UL Listed	
Surge	IEEE C62.41 Category A	
ESD	IEC 801-2, Level 3, Criterion ≤ 2	
Susceptibility	IEC 801-3, Level 3, Criterion ≤ 2	
Electrical Fast Transient/Burst	IEC 801-4, Level 4, Criterion ≤ 2	
Emissions	FCC Part 15, Subpart B, Class B	
Transportation	ISTA Project 1A	

LIMITED WARRANTY

Liebert Corporation extends the following LIMITED WARRANTY to the purchaser and to its customer (collectively referred to as the "Purchaser"): the enclosed Uninterruptible Power System (UPS) and components are free from defects in materials and workmanship under normal use, service, and maintenance FOR A PERIOD OF TWO YEARS FROM THE DATE OF ORIGINAL PURCHASE from Liebert or the Liebert dealer or retailer. THE FOREGOING WARRANTY IS THE ONLY WARRANTY GIVEN AND NO OTHER WARRANTY IS PROVIDED, EXPRESS OR IMPLIED, INCLUDING WITHOUT LIMITATION, MERCHANTABILITY OR FITNESS FOR A PARTICULAR PURPOSE. Certain aspects of disclaimers are not applicable to consumer products acquired by individuals and used for personal, family, or household purposes (as distinguished from industrial or other purposes). Local laws may not allow limitations on how long an implied warranty lasts, so the above limitation may not apply to you. This warranty gives you specific legal rights, and you may have other rights which vary according to local law.

Certain repairs or services are the responsibility of the Purchaser and the Purchaser is expected to pay for them. This warranty does not extend either to products with removed or altered serial numbers or to any losses or damages due to act of God or source external to the product, misuse, accident, abuse, neglect, negligence, unauthorized modification, alteration, or repair, use beyond rated capacity, or improper installation, maintenance, application or use, including, without limitation, use in a manner contrary to the accompanying instructions or applicable codes. WARNING: Warranty is void if the battery is allowed to discharge below the minimum battery cutoff point. To prevent such discharge DO NOT leave the unit power switch "ON" for more than two (2) days without AC power being supplied to the UPS. The battery must be recharged every four (4) to six (6) months when not in use.

If the UPS fails to conform with the above warranty within the two year warranty period, Liebert will repair or replace the UPS, at Liebert's option. Repairs or replacements are warranted for the remainder of the original warranty period. To make a warranty claim, purchaser should call a Liebert Representative to obtain a Returned Goods Authorization number and shipping instructions. Return transportation costs to Liebert are the responsibility of the Purchaser.

"LIFE SUPPORT" POLICY

This product is not recommended, and the Company will not knowingly sell this product, for use with life support and other designated "critical" devices. ANY SUCH USE BY A USER AUTOMATICALLY VOIDS AND DISCLAIMS ANY AND ALL WARRANTIES, INCLUDING ANY IMPLIED WARRANTY OF MERCHANTABILITY, IMPLIED WARRANTY OF FITNESS FOR A PARTICULAR PURPOSE, AND EXPRESS WARRANTIES THAT THIS PRODUCT WILL CONFORM TO ANY AFFIRMATION OR PROMISE, FOR THIS PRODUCT AND THE USER AGREES THAT IN NO EVENT SHALL THE COMPANY BE LIABLE FOR CONSEQUENTIAL OR INDIRECT DAMAGES.



POWERSURE™ PERSONAL

**300- 500 VA
115V**

Technical Support

U.S.A.	1-800-222-5877
Outside the U.S.A.	+1 614-841-6755
U.K.	+44 1628 403 200
France	+33 1 4 360 26 19
Germany	+49 21669649340
Italy	+39 2 98250 1
Netherlands	+00 31 475 504050
E-mail	upstech@liebert.com
Web site	www.liebert.com
Worldwide FAX tech support	+614-841-5471

The Company Behind The Products

With more than 500,000 installations around the globe, Liebert is the world leader in computer protection systems. Since its founding in 1965, Liebert has developed a complete range of support and protection systems for sensitive electronics:

- Environmental systems: close-control air conditioning from 1.5 to 60 tons.
- Power conditioning and UPS with power ranges from 250 VA to more than 1000 kVA.
- Integrated systems that provide both environmental and power protection in a single, flexible package.
- Monitoring and control — on-site or remote — from systems of any size or location
- Service and support, through more than 100 service centers around the world, and a 24-hour Customer Response Center.

While every precaution has been taken to ensure accuracy and completeness of this literature, Liebert Corporation assumes no responsibility, and disclaims all liability for damages resulting from use of this information or for any errors or omissions.

© 2001 Liebert Corporation
All rights reserved throughout the world. Specifications subject to change without notice.

© Liebert and the Liebert logo are registered trademarks of Liebert Corporation. All names referred to are trademarks or registered trademarks of their respective owners.

SL-23265 (2/01) Rev. 2