

JVC

COMPACT VHS CAMCORDER

GR-SXM301AS GR-SXM265AS GR-SXM201AS

INSTRUCTIONS

ENGLISH

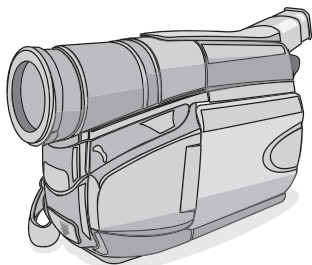

S **VHS** **G** VHS
PAL
625

Super VHS
Super VHS ET

AUTOMATIC DEMONSTRATION

Automatic Demonstration takes place when "DEMO MODE" is set to "ON" (factory-preset).

- Available when the Power Switch is set to "A" or "M".
- To cancel Automatic Demonstration, set "DEMO MODE" to "OFF" (☞ pg. 15).

CONTENTS

GETTING STARTED	4 ~ 8
RECORDING/PLAYBACK	9
BASIC FEATURES	9 ~ 11
MENU SETTINGS	12 ~ 16
REFERENCES	18 ~ 23

Dear Customer,

Thank you for purchasing the JVC Compact VHS camcorder. Before use, please read "SAFETY PRECAUTIONS" (☞ pg. 3) to ensure safe use of this product.

LYT1367-001A

PROVIDED ACCESSORIES



Battery Pack
BN-V10U

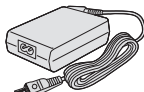

AC Adapter
AP-V14A

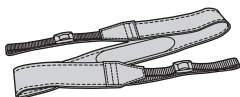

Shoulder Strap

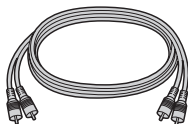

A/V (Audio/Video)
Cable



Lens Cap

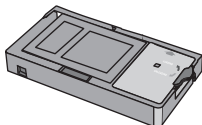

Cassette Adapter
C-P8U

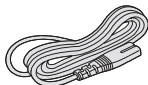

Power Cord

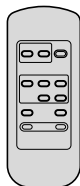

Remote Control Unit
RM-V715U
(GR-SXM301AS /
GR-SXM265AS only)

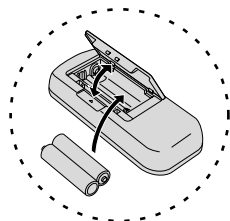

AAA (R03) Battery x 2
(for Remote Control Unit,
GR-SXM301AS /
GR-SXM265AS only)

NOTE:

In order to maintain optimum performance of the camcorder, provided cables may be equipped with one or more core filter. If a cable has only one core filter, the end that is closest to the filter should be connected to the camcorder.

OPTIONAL ACCESSORIES

- **Battery Packs** BN-V12U, BN-V20U, BN-V400U
- **Compact S-VHS (S VHS) Cassettes** SE-C45/30
- **Compact VHS (VHS) Cassettes** EC-60/45/30
- **Active Carrying Bag** CB-V7U

Some accessories are not available in some areas.

Please consult your nearest JVC dealer for details on accessories and their availability.

SAFETY PRECAUTIONS

WARNING:
TO PREVENT FIRE OR SHOCK HAZARD,
DO NOT EXPOSE THIS UNIT TO RAIN OR
MOISTURE.

CAUTIONS

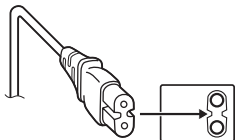

To avoid electrical shock or damage to the unit, first firmly insert the small end of the power cord into the AC Adapter until it is no longer wobbly, and then plug the larger end of the power cord into an AC outlet.

CAUTIONS

- If you notice smoke or a peculiar smell coming from the camcorder or AC adapter, shut it down and unplug it immediately. Continue using the camcorder or AC adapter under these conditions could lead to fire or electric shock. Contact your JVC dealer. Do not attempt to repair the malfunction yourself.
- To prevent shock, do not open the cabinet. No user serviceable parts inside. Refer servicing to qualified personnel.
- When you are not using the AC Adapter for a long period of time, it is recommended that you disconnect the AC Adapter from AC outlet.
- The socket outlet shall be installed near the equipment and easily accessible, or the mains plug or an appliance coupler shall remain readily operable.
- In certain areas, use the conversion plug depending on the type of your AC wall outlet.

NOTES:

- The rating plate (serial number plate) and safety caution are on the bottom and/or the back of the main unit.
- The rating information and safety caution of the AC Adapter are on its bottom.



Only cassettes marked **S-VHS** and **VHS** can be used with this camcorder. However, S-VHS recordings are possible only with cassettes marked **S-VHS**.

CAUTIONS

- This camcorder is designed to be used with PAL-type colour television signals. It cannot be used for playback with a television of a different standard. However, live recording and LCD monitor viewfinder playback are possible anywhere.
- Use the JVC BN-V10U/ V12U/ V20U/ V400U battery packs and, to recharge them or to supply power to the camcorder from an AC outlet, use the provided multi-voltage AC Adapter. (An appropriate conversion adapter may be necessary to accommodate different designs of AC outlets in different countries.)

When the equipment is installed in a cabinet or on a shelf, make sure that it has sufficient space at least 10 cm on all sides to allow ventilation.

Do not block the ventilation holes.

No naked flame sources, such as lighted candles, should be placed on the apparatus. When discarding batteries, environmental problems must be considered and the local rules or laws governing the disposal of these batteries must be followed strictly.

Prevent water or liquid from entering this equipment, keep it away from wet places.

CONTROLS, CONNECTORS AND INDICATORS

Refer to this diagram while reading the instructions.

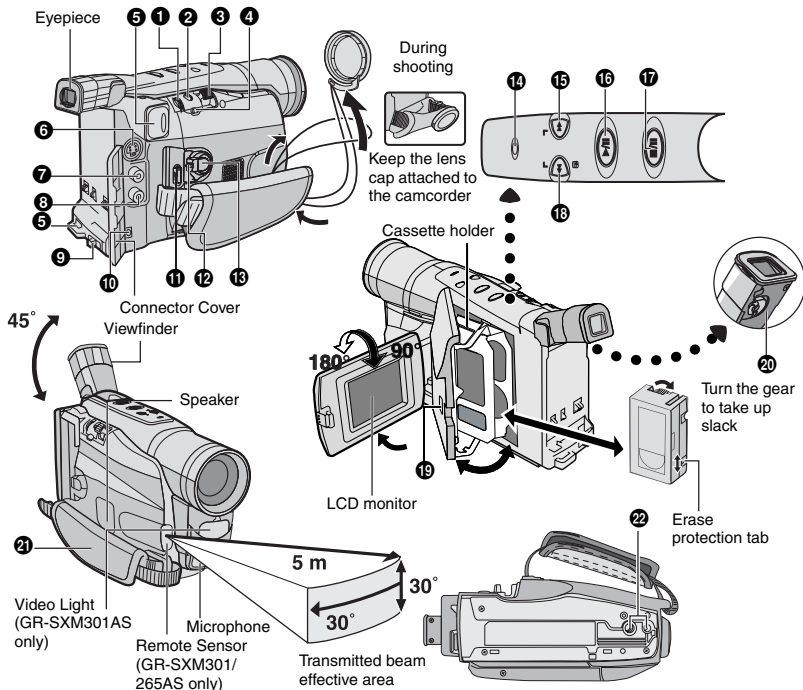

LCD Monitor/Viewfinder Indications



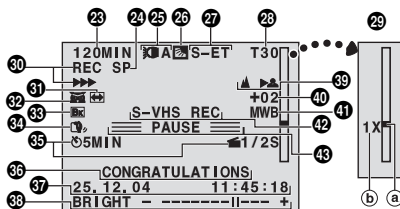



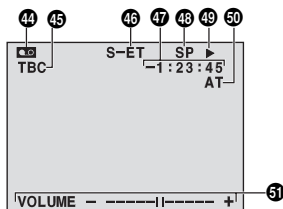















During Recording



During Playback



pg. 18 for "Warning Indications"

- 1 • MENU Wheel [-, +]  pg. 7
 - BRIGHT Wheel [-, +]  pg. 15
 - Speaker Volume Control [VOL.]  pg. 9
 - TRACKING Wheel [-, +].....  pg. 10
- 2 • Snapshot Button [SNAPSHOT]¹  pg. 9
 - 5- Second Recording Button [5 SEC. REC]²  pg. 9
- 3 • Power Zoom Lever [T/W]  pg. 10
- 4 • Manual Focus Button [ FOCUS]....  pg. 10
 - Time Base Corrector Button [TBC]  pg. 10
- 5 • Shoulder Strap Eyelets  pg. 8
- 6 • S-Video Output Connector [S].....  pg. 11
- 7 • Audio Output Connector [A]  pg. 11
- 8 • Video Output Connector [V]  pg. 11
- 9 • Battery Release Switch [BATTERY RELEASE]  pg. 6
- 10 • DC IN Connector  pg. 6
- 11 • Recording Start/Stop Button  pg. 9
 - REFRESH Button  pg. 6
- 12 • Lock Button  pg. 6
- 13 • Power Switch [PLAY, OFF,  , ]  pg. 9
- 14 • POWER/CHARGE Lamp  pg. 6
- 15 • Retake Forward Button [RETAKE F] ..  pg. 10
 - Fast-Forward Button [F]  pg. 9
- 16 • Play/ Pause Button  pg. 9
 - Backlight Compensation Button  pg. 10
- 17 • Stop Button [STOP].....  pg. 9
 - Eject [EJECT] Button  pg. 8
- 18 • Retake Rewind Button [RETAKE R]...  pg. 10
 - Quick Review Button [ R]  pg. 10
 - Rewind Button [R]  pg. 9
- 19 • Close Button  pg. 8
- 20 • Dioptre Adjustment Control  pg. 8
- 21 • Grip Strap  pg. 8
- 22 • Tripod Mounting Socket  pg. 8
- 23 • Tape Remaining Time.....  pg. 15
- 24 • Recording Mode Indicator  pg. 14
- 25 • Video Light Indicator¹  pg. 12
- 26 • Backlight Compensation Indicator  pg. 10
- 27 • Recording Format Indicator (S/ S-ET)  pg. 16
- 28 • Tape Length Indicator  pg. 15
- 29 • Zoom Indicator Bar  pg. 10
 - a) Zoom Level Indicator
 - b) Approximate Zoom Ratio
- 30 • Recording Indicator  pg. 9
- 31 • Digital Effect Indicator  pg. 13
- 32 • Programme AE Indicator  pg. 13
 - Night-Scope Indicator¹  pg. 12
- 33 • Fade/Wipe-Standby Indicator.....  pg. 13
- 34 • Picture Stabiliser Indicator  pg. 14
- 35 • Interval Time/Recording Time Indicator...  pg. 15
 - 5 Sec. Rec Mode Indicator²  pg. 9
- 36 • Instant Title Display  pg. 14
- 37 • Date/Time Display  pg. 15
- 38 • Bright Level Indicator  pg. 15
- 39 • Focus Indicator  pg. 10
- 40 • Exposure Control Level Counter  pg. 12
- 41 • White Balance Mode Indicator  pg. 14
- 42 • S-VHS/S-VHS ET Recording Indicator  pg. 16
- 43 • Record-Standby Mode Indicator  pg. 9
- 44 •  : Cassette Indicator.....  pg. 18
 -  : Insert Editing Indicator³  pg. 17
- 45 • TBC Indicator  pg. 10
- 46 • Recording Format Indicator (S/S-ET)  pg. 16
- 47 • Tape Counter  pg. 16
- 48 • Recording Mode Indicator (SP/LP)  pg. 14
- 49 • Tape Running Indicator
 - ▶: Playback
 - ▶▶: Fast-Forward/ Shuttle Search
 - ◀◀: Rewind/ Shuttle Search
 - ||: Pause
- 50 • Tracking Indicator  pg. 10
- 51 • VOLUME: Speaker Volume Indicator  pg. 9

*1 GR-SXM301AS only.

*2 GR-SXM265AS/SXM201AS only

*3 GR-SXM301/SXM265AS only

GETTING STARTED

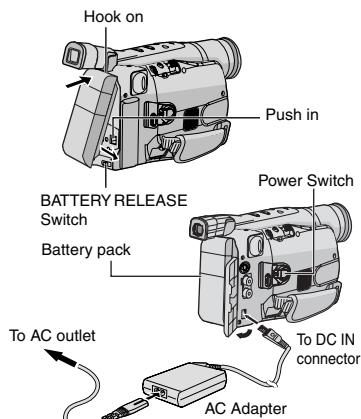

Charging the Battery Pack

- Hook the end of the battery pack to the camcorder and push the battery in until it locks in place.
 - If the battery pack is attached wrongly, a malfunction may occur.
- Set the Power Switch **13** to "OFF" while pressing down the Lock Button **12**. Connect the AC Adapter to the DC IN connector **10**, then connect the Power Cord to the AC adapter.
- The CHARGE lamp **14** blinks to indicate charging.
- When the CHARGE lamp **14** stops blinking and turns off, charging is finished. Unplug the AC Adapter from the AC outlet. Disconnect the AC Adapter from the camcorder.

To Detach The Battery Pack...

... slide BATTERY RELEASE **9** and pull out the battery pack.

Battery Pack	Charging time
BN-V10U	approx. 1 hr. 30 min.
BN-V12U (optional)	approx. 1 hr. 40 min.
BN-V20U (optional)	approx. 2 hrs. 40 min.
BN-V400U (optional)	approx. 5 hrs. 10 min.

Charging time is for a fully discharged battery pack.

Using the Battery Pack

Perform step 1) of "Charging the Battery Pack".
Approximate recording time (unit: min.)

Battery Pack	Viewfinder on	LCD monitor on
BN-V10U	100 (90)	80 (70)
BN-V12U (optional)	105 (95)	85 (75)
BN-V20U (optional)	170 (155)	140 (120)
BN-V400U (optional)	400 (350)	330 (285)

(): When the video light is on
(GR-SXM301AS only)

Using AC Power

Connect the AC Adapter to the camcorder (step 2) of "Charging the Battery Pack".

- The provided AC Adapter features automatic voltage selection in the AC range from 110V to 240V.

ATTENTION:

Before detaching the power source, make sure that the camcorder's power is turned off. Failure to do so can cause the camcorder to malfunction.

REFRESH:

Be sure to fully discharge a battery pack before recharging or storing it for a long period of time, otherwise the battery performance will be reduced.

- Perform steps 1) through 3) of "Charging the Battery Pack".
- Press REFRESH **11** for over 4 seconds. The CHARGE lamp **14** blinks faster to indicate discharging.
- When discharging is finished, charging automatically starts and the CHARGE lamp **14** blinks normally.

Date/Time Settings

• The following steps have the same function as "REFRESH" (⇨ pg. 6).

- 1) Attach the battery to the camcorder with no cassette inserted.
 - 2) Set the Power Switch **13** to "A" or "M" while pressing down the Lock Button **12**.
- During charging or discharging, the camcorder cannot be operated.
 - Charging and discharging are not possible if the wrong type of battery is used.
 - When charging the battery pack for the first time or after a long storage period, the CHARGE lamp **14** may not light. Remove the battery pack from the camcorder, then try charging again.
 - If a fully-charged battery's operation time remains extremely short, the battery is worn out. Please purchase a new one.
 - Perform charging where the temperature is between 10°C and 35°C. 20°C to 25°C is the ideal temperature range. If the environment is too cold, charging may be incomplete.
 - Charging time varies according to the ambient temperature and the status of the battery pack.
 - Since the AC Adapter processes electricity internally, it becomes warm during use. Be sure to use it only in well-ventilated areas.
 - Using the optional AA-V15 AC Power Adapter/Charger, you can charge the BN-V10U/V12U/V20U/V400U battery pack without the camcorder.

However, it cannot be used as an AC adapter.

- To avoid interference with reception, do not use the AC Adapter near a radio.
- Recording time is reduced significantly when Zoom or Record-Standby mode is engaged repeatedly or the LCD monitor is used repeatedly.
- Before extended use, it is recommended that you prepare enough battery packs to cover 3 times the planned shooting time.

- 1) Set the Power Switch **13** to "M" while pressing down the Lock Button **12**.
 - 2) Press the MENU Wheel **1** in. The TOP MENU Screen appears.
 - 3) Rotate the MENU Wheel **1** to select "▶TO SYSTEM MENU" and press it.
 - 4) Rotate the MENU Wheel **1** to select "▶DATE/TIME SET" and press it. The DATE/TIME SET Menu appears.
 - 5) To set "YEAR", "MONTH", "DAY" or "TIME" (hour/minute), rotate the MENU Wheel **1** to select the desired item, and press it. When the setting begins blinking, rotate the MENU Wheel **1** until the correct setting appears and then press it. The setting stops blinking.
 - 6) When none of these settings ("YEAR", "MONTH", "DAY", "TIME") blinks, rotate the MENU Wheel **1** to select "▶RETURN" and press it, to go to Menu Screen.
 - 7) Press the MENU Wheel **1** in to select "▶EXIT" to close the Menu Screen.
- To display the date and time in the camcorder's display and on a connected TV, see DATE/TIME DISP (⇨ pg. 15) in SYSTEM MENU.
 - The date/time cannot be stored in memory if the built-in clock battery runs out. Consult an authorised JVC dealer for replacement, or set the date/time as necessary before you start shooting.

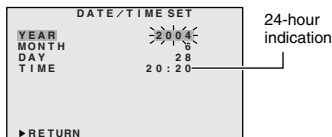

Grip Adjustment

- 1) Separate the Velcro strip.
- 2) Pass your right hand through the loop and grasp the grip.
- 3) Adjust so that your thumb and fingers can easily operate the Recording Start/Stop Button **11** and Power Zoom Lever **3**. Refasten the Velcro strip.

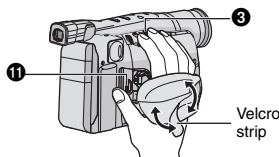

Viewfinder Adjustment

- 1) Set the Power Switch **13** to "A" or "M" while pressing down the Lock Button **12**.
- 2) Make sure the LCD monitor is closed and locked. Pull up the viewfinder and adjust it manually to get the best view.
- 3) Turn the Dioptre Adjustment Control **20** until the indications in the viewfinder are clearly focused.

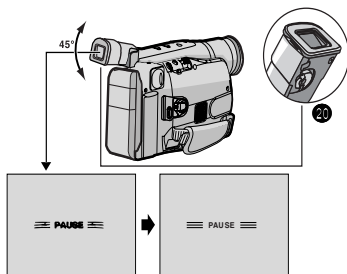

Shoulder Strap Attachment

Thread the strap through the eyelet **5**, then fold it back and thread it through the buckle. Repeat the procedure to attach the other end of the strap to the other eyelet **5**, making sure the strap is not twisted. Adjust the length.

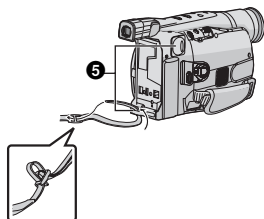

Tripod Mounting

Align the screw and camera direction stud on the tripod with the tripod mounting socket **22**. Then tighten the screw.

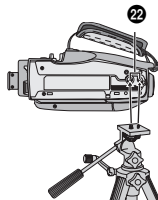

CAUTION :

When using a tripod, be sure to extend its legs fully to stabilise the camcorder. To prevent damage to the unit caused by falling over, do not use a small tripod.

Loading/Unloading A Cassette

- 1) Open the LCD monitor fully and keep it aligned vertically with the camera (do not tilt it). Press EJECT **17** for more than 2 seconds until the cassette holder opens. Do not force open.
- 2) When inserting a cassette, make sure the label is facing outward.
- 3) Press the Close button **19** to close the cassette holder until it locks in place. Close the LCD monitor.
 - Closing the LCD monitor while the cassette holder is still open may cause damage to the LCD monitor.
 - Make sure the erase protection tab is in the position that allows recording. If not, slide the tab. Some cassettes have removable tabs. If the tab has been removed, cover the hole with adhesive tape.
 - The cassette holder cannot be opened while the camcorder is in record mode or detached from power source.

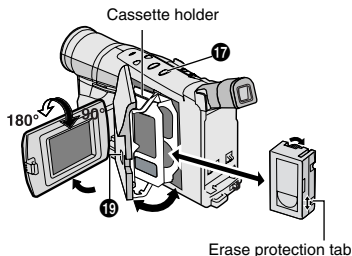

RECORDING

Set REC MODE, S-VHS (S-VHS ET), TAPE LENGTH and DATE/TIME. (☞ pg. 12 – 16, “MENU SETTINGS”)

- 1) Remove the lens cap. Set the Power Switch **13** to “A” or “M” while pressing down the Lock Button **12**.

Shooting while using the viewfinder: Make sure the LCD monitor is closed and locked.

Shooting while using the LCD monitor:

Make sure the LCD monitor is fully open.

The camcorder is in Record-Standby mode and “PAUSE” **13** is displayed.

- The viewfinder and LCD monitor cannot be used simultaneously. Therefore, when opening the LCD monitor and tilting it upward to 180°, you cannot view any image in the viewfinder. However, you can shoot yourself while viewing your own image on the LCD monitor.
- 2) Press the Recording Start/Stop Button **11**. REC **30** appears while recording is in progress.
 - To stop recording, press the Recording Start/Stop Button **11**. The camcorder re-enters Record-Standby mode.

To Adjust The Brightness Of The LCD Monitor:

When the Power Switch **13** is set to “M”, adjust “LCD BRIGHT” in SYSTEM MENU (☞pg. 15).

PLAYBACK

- 1) Load a tape (☞pg. 8, “Loading/Unloading A Cassette”).

- 2) Set the Power Switch **13** to “PLAY” while pressing down the Lock Button **12**. To start playback, press ►/II **16**.

To stop playback temporarily (Still Playback), press ►/II **16**. To stop playback, press ■ **17**. Press ◀◀ **18** to rewind, or ▶▶ **15** to fast-forward. High-speed picture search (Shuttle Search) is possible by pressing ◀◀ **18** or ▶▶ **15** during playback.

During playback, holding ◀◀ **18** or ▶▶ **15** down continues the search as long as you hold the button.

For VIDEO RECORDING/VIDEO PLAYBACK

- The camcorder shuts off automatically after about 5 minutes in the Record-Standby or Stop mode. To turn on again, set the Power Switch **13** to “OFF”, then to “A”, “M” or “PLAY”.
- When the Power Switch **13** is set to “A”, “M” or “PLAY”, and the LCD monitor is opened at an angle of 60 degrees or more, the LCD monitor switches on and the viewfinder switches off automatically to save power.
- The playback picture can be viewed in the viewfinder (with the LCD monitor shut), on the LCD monitor or on a connected TV (☞pg. 11, “Connections To A TV/VCR”).
- To control the speaker volume **51**, rotate the MENU Wheel **1** towards “+” to turn up, or towards “-” to turn down. While shooting, sound is not heard from the speaker.
- Noise bars appear and pictures may become monochrome or darken during Shuttle Search. This is normal.
- If TBC is engaged during Still Playback, noise bars will not appear. (GR-SXM301AS only)

BASIC FEATURES

Snapshot

(GR-SXM301AS only)

You can record still images that look like photographs onto a tape.

- 1) Perform step 1) of “RECORDING”.
- 2) Press SNAPSHOT **2**.
 - There is a momentary camera shutter-type blackout together with the sound effect of a shutter closing.
 - Snapshot is also available during playback. However, the shutter sound is not heard.

5Sec. Rec (5-sec. Recording)

(GR-SXM265/201AS only)

To record a scene for 5 seconds, providing quick scene transitions like those seen on TV.

- 1) Make sure the recording mode is set to “SP”.
- 2) During Record-Standby, press 5SEC. REC **2**.
 - ◀ 5S **35** appears and 5Sec. Rec is reserved.
- 3) Press the Recording Start/Stop Buttons **11**. Recording starts, and after 5 seconds, the camcorder re-enters Record-Standby mode automatically.
- 4) To cancel the 5Sec. Rec. function, press 5SEC. REC **2** again so that ▶ 5S **35** disappears.
- Fade/Wipe (☞pg. 13) cannot be activated during 5Sec. Rec.

Backlight Compensation

To increase the brightness of the subject relative to the background.

- 1) Press BACKLIGHT **16** during recording. **16** is displayed and the subject is brightened.
- 2) To cancel Backlight Compensation, press BACKLIGHT **16** again. **16** disappears.
 - Backlight Compensation functions in both recording modes ("**A**" or "**M**").
 - Using BACKLIGHT **16** may brighten the subject, resulting in a washed out or white image.
 - BACKLIGHT **16** and Manual Exposure mode (→pg. 12) cannot be used simultaneously.

Auto/Manual Focus

If correct focus cannot be obtained with Auto Focus, use Manual Focus.

- 1) Set the Power Switch **13** to "**M**" while pressing down the Lock Button **12**.
- 2) Press **M** FOCUS **4**. "**A**" **39** appears.
- 3) To focus on a distant subject, rotate the MENU Wheel **1** upward. "**<**" appears and blinks. To focus on a close subject, rotate the MENU Wheel **1** downward. "**>**" appears and blinks.
- 4) To cancel the Manual Focus, press **M** FOCUS **4**. "**A**" **39** disappears and Auto Focus is applied.
 - When the focus level cannot be adjusted any farther or closer, "**A**" or "**>**" will blink.

Zooming

To produce the zoom in/out effect. Digital circuitry extends the maximum magnification offered by optical zoom. This system is called Digital Zoom.

- Slide the Power Zoom Lever **3** towards "**T**" to zoom in, or "**W**" to zoom out.
- The further you slide the Power Zoom Lever **3**, the quicker the zoom action.
- Focusing may become unstable during Zooming. In this case, set the zoom while in Record-Standby, lock the focus by using the manual focus, then zoom in or out in Record mode.
- The zoom level indicator **29**-**a** moves during zoom. Once the zoom level indicator **29**-**a** reaches the top, all magnification from that point is through digital processing.
- When using Digital Zoom, the quality of image may suffer. To deactivate Digital Zoom, set "D.ZOOM" (→pg. 14) to "OFF" in CAMERA MENU.
- Digital zoom cannot be used when the "V. ECHO" mode (→pg. 13, "Digital Effects") is activated.

Quick Review

To check the end of the last recording.

- 1) Make sure the camcorder is in Record-Standby mode.
- 2) Press **13** and release quickly. Tape is rewound for approx. 1 second and played back automatically, then pauses in Record-Standby mode for the next shot.
 - Distortion may occur at the start of playback. This is normal.

Retake

To re-record certain segments.

- 1) Make sure the camcorder is in Record-Standby mode.
- 2) Press and hold either RETAKE **15** or **16** to reach the start point for new recording.
- 3) Press the Recording Start/Stop Button **11** to start recording.
 - Noise bars appear and pictures may become monochrome or darken during Retake. This is normal.

Tracking

Eliminates noise bars that appear on-screen during playback. To activate Manual Tracking:

- 1) Press the TRACKING Wheel **1** for approx. 2 seconds. "MT" **50** appears.
- 2) Rotate the TRACKING Wheel **1** so that the noise bars disappear.
 - To return to Auto Tracking, press the TRACKING Wheel **1** for approx. 2 seconds or set the Power Switch **13** to "OFF" and then "PLAY" again. "AT" **50** blinks. When Auto Tracking finishes, the indication disappears.
 - When noise bars appear during playback, the camcorder enters the Auto Tracking mode and "AT" **50** appears.
 - Manual Tracking may not work with tapes recorded on other VCRs or camcorders.

TBC (Time Base Corrector)

Removes jitter from fluctuating video signals to deliver a stable picture even with old tapes.

To activate/release the TBC mode, press TBC **4** during playback for more than 1 second. "TBC" **45** is displayed.

- The "TBC" indicator **45** turns green (grey with a camcorder equipped with a black/white viewfinder) while TBC is working, and white while TBC is not operative.
- TBC does not work during Still Playback and Shuttle Search (→pg. 9).
- It may take a few seconds before TBC actually starts working.
- The picture may be distorted if the TBC mode is activated or deactivated at the edit-in/-out points or when normal playback resumes after Still Playback or Shuttle Search (→pg. 9).

- If the playback picture is distorted when TBC is set to on, turn off TBC.

Connections To A TV/VCR

- 1) Make sure all units are turned off.
 - 2) Connect the camcorder to a TV or VCR. If using both TV and VCR, connect the VCR output to the TV input.
 - 3) Turn on all units. Set the VCR to its AUX input mode, and set the TV to its VIDEO mode.
- Use the AC Adapter as the power supply.
 - The S-Video cable connection can improve the dubbed picture quality. A commercially available S-Video cable is required.
 - Be sure to lower the TV volume to its minimum to avoid a sudden burst of sound when the camcorder is turned on.
 - If you have a TV or speakers that are not specially shielded, do not place the speakers adjacent to the TV as interference will occur in the camcorder playback picture.

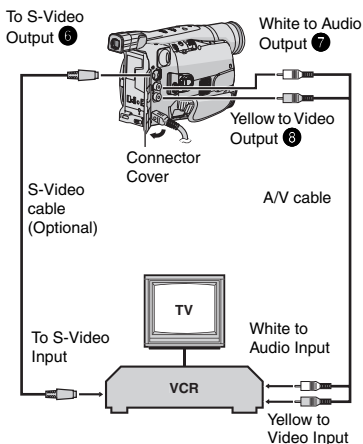

Tape Dubbing

- 1) Connect the camcorder and the VCR (see pg. 11, "Connections To A TV/VCR"). Set the Power Switch (13) to "PLAY" while pressing down the Lock Button (12), turn on the VCR's power, and insert the appropriate cassettes in the camcorder and the VCR. Engage the VCR's AUX and Record-Pause modes.
- 2) Press ►/|| (16) to find a spot just before the edit-in point. Once it is reached, press ►/|| (16) again.
- 3) Press ►/|| (16) and engage the VCR's Record mode.
- 4) Engage the VCR's Record-Pause mode and press ►/|| (16).

- Repeat steps 2) through 4) for additional editing, then stop the VCR and camcorder when finished.

Using The Cassette Adapter

Use this to play back an S-VHS-C/VHS-C video cassette recorded with this camcorder on a S-VHS/VHS VCR.

- 1) Slide the latch (1) to open the compartment door, then insert the cassette and close the compartment door (2).
- If the colour shown in the window (4) is green or red, turn the dial (5) in the direction of "UNLOADING" so that colour changes to blue.
- 2) Turn the dial (5) in the direction of "LOADING" all the way until it stops.
- The color shown in the window (4) changes from blue → red → green (indicating playback is possible).
- 3) Load the cassette adapter into the VCR and play the tape back.
- To record on a VCR using a compact cassette and the adapter, cover the adapter's recording safety hole with Adhesive tape.
- 4) To unload the cassette, turn the dial (5) in the direction of "UNLOADING" all the way until it stops.
- The color shown in the window (4) changes from green → red → blue (indicating unloading is possible).
- 5) Slide the latch (1) to open the compartment door, then insert your finger in the hole (6), and push up and remove the cassette.
- 6) Close the compartment door (2).

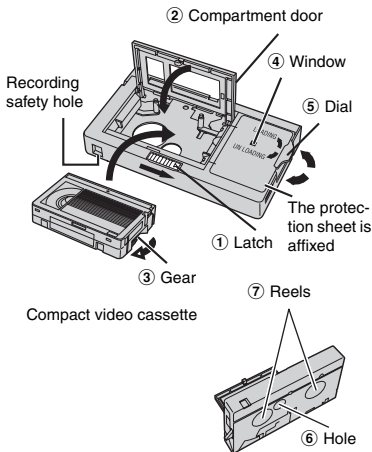

- If there is slack in the video tape when inserting the compact cassette into the

adapter, the tape may become damaged. To take up slack in the tape, turn the gear ③ in the direction of the arrow.

- During tape loading and unloading, do not touch the reels ⑦ for safety and tape protection.
- Tapes recorded in S-VHS or S-VHS ET mode cannot be played back on a regular VHS VCR. Playback is possible with a VCR equipped with the S-VHS function.
- During special-effect playback (slow motion, still frame, etc.), the picture may vibrate or noise bars may appear on the screen.

MENU SETTINGS

This Menu Screen cannot be accessed while recording.

- 1) Set the Power Switch ⑬ to "M" while pressing down the Lock Button ⑫.
- 2) Press the MENU Wheel ① in. The TOP MENU Screen appears. Rotate the MENU Wheel ① to select the desired menu or function and press it.

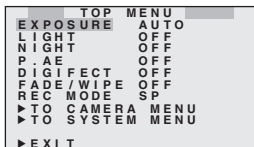

- To go from TOP MENU to CAMERA MENU, rotate the MENU Wheel ① to select "▶ TO CAMERA MENU" and press it.

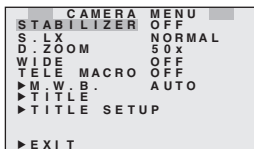

- To go from TOP MENU to SYSTEM MENU, rotate the MENU Wheel ① to select "▶ TO SYSTEM MENU" and press it. SYSTEM MENU has 2 pages. To go to the next page, rotate the MENU Wheel ① to select "▶ TO SYSTEM MENU 2" and press it.

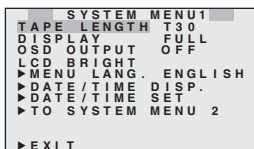

- 3) Rotate the Menu Wheel ① to select the desired setting and press it.
- 4) Press "▶ EXIT" to exit from any menu.

TOP MENU

EXPOSURE

Manual exposure adjustment is recommended in the following situations:

- When shooting using reverse lighting or when the background is too bright.
- When shooting on a reflective natural background such as at the beach or in the snow.
- When the background is overly dark or the subject light.

1) Rotate the MENU Wheel ① to select "MANUAL", then press it.

2) To brighten the image, rotate the MENU Wheel ① downward.

To darken the image, rotate the MENU Wheel ① upward.

The exposure control level increases/decreases (maximum ± 06).

LIGHT (Video Light)

(GR-SXM301AS only)

To brighten the scene when natural lighting is too dim.

OFF : Turns off the light.

AUTO: Automatically turns on the light when the camcorder senses insufficient lighting on the subject.

ON : Always keeps the light on as long as the camcorder is turned on.

- It is recommended to set M.W.B. (pg. 14) to in CAMERA MENU when you use the video light.
- The battery pack's charge may be low even though the battery indicator () does not blink, the camcorder may turn off automatically when you turn on the video light, or when you start recording with the video light turned on.
- When the Video Light mode is set to "AUTO":
 - Depending on the lighting conditions, the video light may keep turning on and off.
 - While the "Sports" or "High Speed Shutter" mode is engaged, the light is likely to stay on. While the "Twilight" mode is engaged, the light will not activate. (pg. 13, "Programme AE with Special Effects")

NIGHT (Night-Scope)

(GR-SXM301AS only)

To make dark subjects or areas even brighter than they would be under good natural lighting.

OFF: To cancel the effect.

000 A AUTO : The shutter speed is automatically adjusted (maximum 1/2 sec.).

000 1 20X: The shutter speed is set to 2/5th of a second to provide 20 times the sensitivity.

000 2 50X : The shutter speed is set to 1 second to provide 50 times the sensitivity.

 **LIGHT** : The camcorder's light is on and the shutter speed is automatically adjusted (maximum 1/2 sec.).

- During Night-Scope, the following cannot be activated: "Picture Stabiliser", "Programme AE With Special Effects", "Digital Effects" and "S.LX" in the menu settings.
- During Night-Scope, it may be difficult for focusing. To prevent this, use of a tripod is recommended.

P. AE (Programme AE with special effects)



- In the "High Speed Shutter" or "Sports" modes, picture colour may be adversely affected if the subject is lit by alternating discharge-type light sources such as fluorescent or mercury-vapour lights.

OFF: To cancel the effect.

 **SPORTS**: High shutter speed clearly captures fast-moving action.

ND EFFECT: A black mist darkens the picture, as when an ND filter is used. Helps to counter the effects of glare on the subject.

FOG: Makes the picture look misty white, as when an external fog filter is attached to the lens. Softens the image and gives it a "fantasy" look. This mode cannot be used when the "V.ECHO" mode ( "Digital Effects") is activated.

 **TWILIGHT**: Dusk, twilight scenery, fireworks, etc., look more natural and dramatic. In this mode, the Auto Focus () and S.LX () may not work.

 **1/2000 (1/2000 sec. High Speed Shutter)**: Captures faster action than Sports mode. The screen becomes slightly dark. Use in well-lit environment.

 **SUNSET**: Makes scenes look like a sunset with reddish tint.

 **SURF&SNOW**: Compensates for subjects that may otherwise appear too dark when shooting in extremely bright surroundings such as in the snow or beach. In this mode, the fast-moving images can be recorded since the shutter speed becomes fast.

DIGIFECT (Digital Effects)

OFF: To cancel the effect.

 **SEPIA**: Recorded scenes have a brownish tint like old photos. Combine this with WIDE in CAMERA MENU for a classic look.

B/W:MONO : Like black and white films, your footage is shot in B/W. Combine this with WIDE in CAMERA MENU for a classic look.

 **B. FILTER**: Recorded scenes have a bluish tint.

 **R. FILTER**: Recorded scenes have a reddish tint.

 **SOLARI**: The picture is recorded with an effect similar to a painting.

 **NEGAPOSI**: The colours of a picture are reversed.

 **MOSAIC**: Turns recorded scenes into a mosaic pattern.

 **STRETCH**: Doubles the width of the picture horizontally.

 **CLASSIC***: Makes your footage look like a classic movie by shooting in black and white, with a strobing effect, and black bars added at the top and bottom.

 **STROBE***: Your recording looks like a series of consecutive snapshots.

 **V. ECHO* (Video Echo)**: Adds a "ghost" to the subject, giving your recording a "fantasy" feeling. Zoom magnification of over 10X is not available.

* GR-SXM301AS only.

FADE/WIPE

Fade- or wipe-in works when recording begins, and fade- or wipe-out works when recording ends.

- Pressing and holding the Recording Start/Stop Button  allows you to vary the length for the image during fade in/out or wipe in/out.

OFF: To cancel the effect.

 **FADER**: Fades in/out to a black screen.

 **FADER**: Fades in/out to a white screen.

 **MOSAIC (Fader)**: Gradually turns/returns the picture into/from a mosaic pattern.

 **SHUTTER (Wipe)**: A black screen moves in from the top and bottom, closing over the image like a shutter, or a new image pushes open the black screen vertically from the centre.

 **SLIDE (Wipe)**: A black screen moves in from the left to gradually cover the image, or a new image moves in from right to left.

 **DOOR (Wipe)**: Wipes in as the two halves of a black screen open to the left and right, revealing the scene, or wipes out and the black screen reappears from left and right to cover the scene.

 **CORNER (Wipe)**: Wipes in on a black screen from the upper right to the lower left corner, revealing the scene, or wipes out from lower left to upper right, leaving a black screen.

 **WINDOW (Wipe)**: Wipes in on a black screen from the centre of the screen towards the corners, revealing the scene, or wipe out from the corners to the centre, leaving a black screen.

 **SCROLL (Wipe)**: Wipes in on a black screen from the bottom to the top, revealing the scenes, or wipes out from the top to the bottom, leaving a black screen.

REC MODE

Allows you to set the recording mode. "LP" (Long Play) is more economical, providing twice the recording time.

- If the recording mode is switched, the playback picture will be blurred at the switching point.

CAMERA MENU**STABILIZER**

The Picture Stabiliser compensates for unstable images caused by camera-shake, particularly at high magnification.

ON: The Picture Stabiliser is activated.

 34 appears.

OFF: The Picture Stabiliser is deactivated.

 34 disappears.

- Accurate stabilisation may not be possible in certain conditions including excessive hand shake.
-  34 appears blinking or goes out if the Stabiliser cannot be used.
- This function cannot be activated during the "Night-Scope" (→pg.12), "CLASSIC", "STROBE" and "V. ECHO" modes (→pg. 13, "Digital Effects").

S.LX

MAX: To record a subject in a darkly lit environment, when it is more convenient to shoot the subject with a brighter image even if the picture becomes slightly coarse.

NORMAL: To record a subject in a dimly lit environment, when it is more convenient to shoot with a less coarse picture although the subject becomes slightly dark.

OFF: Allows you to shoot dark scenes with no picture brightness adjustment.

D. ZOOM

Zooming is possible from 25X (the optical zoom limit), to a maximum of 50X or 1000X digital magnification.

When set to "OFF" only optical zoom (maximum 25x magnification) can function.

WIDE

When set to "ON" black bars will be recorded at the top and bottom of the screen to produce a cinema-like "wide-screen" effect.

TELE MACRO

When set to "ON", you can shoot a subject as large as possible at a distance of approx. 40 cm. Depending on the zoom position, the lens may go out of focus.

M.W.B

If the white balance is correct, all other colours will be accurately reproduced.

AUTO : White balance is adjusted automatically.

 **FINE** : Outdoors on a sunny day.

 **CLOUD** : Outdoors on a cloudy day.

 **HALOGEN:** A video light or similar type of lighting is used.

MWB: White balance is set manually. Hold a sheet of plain white paper in front of the subject. Adjust zoom or position yourself so that the white paper fills the screen. If it is difficult to focus on the white paper, adjust focus manually (→pg. 10, "Auto/Manual Focus"). Press the MENU Wheel 1 in until "MWB" 41 begins blinking. When the setting is completed, "MWB" 41 stops blinking.

- Once you adjust white balance manually, the setting is retained even if the power is turned off or the battery is removed.
- White balance cannot be used when the "SEPIA" or "B/W:MONO" mode (→pg. 13, "Digital Effects") is activated.

TITLE

Allows you to superimpose one of eight preset titles in 5 different languages. Change the language in "LANGUAGE" in "TITLE SETUP" in CAMERA MENU.

- 36 shows the selected title which remains until OFF is selected.

TITLE SETUP

Adjust the settings for TITLE.

SIZE : When "LARGE" is selected, the title is twice enlarged vertically than "NORMAL".

SCROLL : When "ON" is selected, the title is scrolled from right to left.

LANGUAGE: Select the language for TITLE.

To set "SIZE", "SCROLL" or "LANGUAGE", rotate the MENU Wheel 1 to select the desired item and press it. When the setting begins blinking, rotate the MENU Wheel 1 until the correct setting appears and then select it. The setting stops blinking.

SYSTEM MENU 1

TAPE LENGTH

Allows you to set the tape length depending on the tape used: T30=30 minutes, T45=45 minutes, T50=50 minutes, T60=60 minutes.

- Tape remaining time **28** is correct only if the correct tape length has been selected.

DISPLAY

FULL: Makes all of the indications appear on the LCD monitor/viewfinder during playback or recording.

SIMPLE: Makes the following indications disappear from the LCD monitor/viewfinder during recording or playback: **29**, **44**, tape remaining time **28**, **44**, tape length **28**.

OSD OUTPUT

ON: On-screen indications are displayed to TV etc.

OFF: On-screen indications are turned off except Date/Time, Instant Title and Warning Indication.

LCD BRIGHT

To adjust the brightness of the LCD monitor, perform the following steps quickly (within approx. 1 second by each interval):

- 1) Select "LCD BRIGHT" in SYSTEM MENU. The "BRIGHT ON" message appears.
- 2) Press the BRIGHT Wheel **1** to return to normal screen.
- 3) Rotate the BRIGHT Wheel **1** to display the bright level indicator **39**.
- 4) Rotate the BRIGHT Wheel **1** until the appropriate brightness is reached. After the BRIGHT Wheel **1** is released, the indicator soon disappears and adjustment is completed.

MENU LANG.

Allows you to select the language (ENGLISH, CHINESE or ARABIC) used in all messages displayed on screen.

DATE/TIME DISP.

The date/time appears in the camcorder or on a connected monitor (set DATE/TIME in SYSTEM MENU first [\(pg. 7\)](#)).

- The selected display will be recorded. If you do not want to record the display, select "OFF" before shooting.
- In the AUTO DATE mode, the camcorder records the date for about 5 seconds when recording is initiated after the date is changed, a cassette is loaded, or AUTO DATE is selected. The date is replaced after 5 seconds with "AUTO DATE" but this is not recorded.

DATE/TIME SET

Allows you to set the current date and time.

([pg. 7](#))

SYSTEM MENU 2

DEMO MODE

Demonstrates certain functions automatically.

Available when the Power Switch **18** is set to "A" or "M" and "DEMO MODE" is set to "ON" (factory-preset).

- To cancel demonstration, set "DEMO MODE" to "OFF".
- Pressing MENU Wheel **1** directly accesses DEMO MODE menu while the demo is in progress.
- Performing any operation during the demonstration stops the demonstration temporarily. If no operation is performed for more than 1 minute after that, the demonstration will resume.
- "DEMO MODE" remains "ON" even if the camcorder power is turned off.
- When a cassette is in the camcorder, demonstration is not available.
- If you do not detach the Lens Cap, you cannot see the actual changes of the Automatic Demonstration activated on the LCD monitor or viewfinder.

REC TIME

You can shoot a series of pictures, each slightly different, of the same object for a brief selected period of time (Animation). REC MODE should be set to "SP".

Select the desired recording time and press the Recording Start/Stop Button **1** after focusing on the subject.

- Fade- or wipe-in/out cannot be performed.
- This function is cancelled when the power is turned off or when the cassette is ejected.
- To use this function, it is recommended that SCROLL in TITLE SETUP ([pg. 14](#)) be set to "OFF".

INT. TIME

You can record sequentially at preset time spans. Leaving the camcorder aimed at a specific subject, you can record subtle changes over an extended period of time (Time-Lapse). REC MODE should be set to "SP".



(Please note that it is necessary to set the REC TIME (Animation) in the SYSTEM MENU before performing the INT.TIME (Time-Lapse) function.) Select the desired interval time and press the Recording Start/Stop Button **1**.

- Fade- or wipe-in/out cannot be performed.

- This function is cancelled when the power is turned off or when the cassette is ejected.
- To use this function, it is recommended that SCROLL in TITLE SETUP (p. 14) be set to "OFF".

S-VHS (S-VHS ET)

ON: With an S-VHS cassette, "S"  appears and the camcorder records in S-VHS.

With a VHS cassette, "S-ET"  appears and the camcorder records with S-VHS picture quality, which is called Super VHS ET (Expansion Technology). "S-VHS REC"  appears during recording.

OFF: Records in VHS on a VHS or S-VHS cassette.





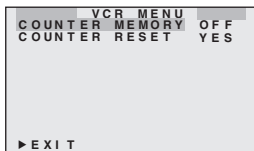







- JVC EHG (Extra High Grade) tapes are recommended for superior results.
- Use S-VHS tape for storing recordings for an extended period or for recording important scenes, as it enables higher-quality recording and playback.
- With some tapes, better picture quality may not be obtained even with S-VHS ET recording. It is recommended that you do test record beforehand to make sure whether better results can be obtained.
- It is recommended that tapes recorded on this camcorder be played back on this camcorder.
- Tapes recorded in S-VHS or S-VHS ET mode can be played back not only on this camcorder but also on a Super VHS VCR.
 - Tapes recorded in S-VHS ET mode cannot be played back on some VCRs, including some JVC VCRs.
- Tapes recorded in S-VHS or S-VHS ET mode cannot be played back correctly on a normal VHS VCR.
- S-VHS ET does not work with S-VHS tapes.
- To avoid on-screen noise, do not perform Still Playback or Shuttle Search repeatedly.
- If the picture contains a lot of jitter or noise, use a cleaning cassette.

VCR MENU



COUNTER MEMORY

Makes it easier to locate a specific tape segment.

- 1) Set the Power Switch  to "PLAY" while pressing down the Lock Button .
 - 2) Press the MENU Wheel  in. The VCR MENU screen appears.
 - 3) Rotate the MENU Wheel  to select "COUNTER MEMORY" and press it. Then, rotate the MENU Wheel  to "ON" and press it. ("M" appears when you return to normal screen.)
 - 4) Rotate the MENU wheel to select "COUNTER RESET" and press it. Then, rotate the MENU Wheel  to "YES" and press it. The counter resets to "0:00:00".
 - 5) To return to normal screen, rotate the MENU Wheel  to "▶EXIT" and press it.
 - 6) After recording or playback, press  , then  with Power Switch  is set to "PLAY". The tape automatically stops at or close to 0:00:00.
 - 7) Press /||  to start playback.
- The counter memory functions in both Fast-Forward and Rewind modes.

USING THE REMOTE CONTROL UNIT (GR-SXM301/265AS only)

The Remote Control Unit can operate this camcorder from a distance as well as the basic operations (Playback, Stop, Pause, Fast-Forward and Rewind) of your VCR. Make sure the remote control is pointed at the remote sensor.

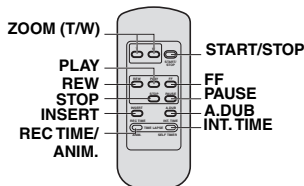

Playback Zoom (GR-SXM301AS only)

To magnify the recorded image up to 10X at any time during playback. Make sure that the TBC mode is activated.

- 1) Press PLAY to find the scene of interest.
 - 2) Press ZOOM (T/W). Pressing T zooms in. To end zoom press and hold W until magnification returns to normal. Or, press STOP and then press PLAY.
- Due to digital image processing, the quality of the image may suffer.

Animation And Time-Lapse

The remote control lets you set/release interval time and recording time without setting REC TIME/INT. TIME (☞ pg. 15) in SYSTEM MENU.

Animation

Each time ANIM. is pressed, the recording time changes in the following order: 1/4S, 1/2S, 1S, 5S and no indication (off).

Time-Lapse

Each time REC TIME is pressed, the recording time changes in the following order: 1/4S, 1/2S, 1S, 5S and no indication (off). Each time INT. TIME is pressed, the interval time changes in the following order: 15S, 30S, 1MIN, 5MIN and no indication (off).

Insert Editing

You can record a new scene onto a previously recorded tape. Only the video signal is recorded in this mode.

- 1) Set the Power Switch 16 to "PLAY" while pressing down the Lock Button 12 located on the switch.
- 2) Play back the tape, locate the edit-out point and press PAUSE. Perform steps 2) through 5) of "COUNTER MEMORY" (☞ pg. 16)
- 3) Press REW to go a little beyond the beginning of the scene you want to replace, press PLAY to view the recorded tape, and press PAUSE

exactly at the edit-in point where the new scene should start.

- 4) While holding down INSERT, press and release PAUSE. ☞ 14 appears.
 - 5) To begin Insert Editing, press START/STOP. When the counter reaches "0:00:00", editing stops automatically and the camcorder enters the Insert-Pause mode. To end Insert Editing, press STOP.
- During Insert Editing, the original audio will be heard from the speaker.
 - After step 4), "Retake" (☞ pg. 10) can be performed.
 - The tape may stop slightly before or after the designated end point, and noise bars may appear. Neither indicates a defect in the unit.

Audio Dubbing

You can record a new soundtrack on a prerecorded tape (normal audio only). The sound is recorded from the built-in microphone.

Perform steps 1) and 2) of the Insert Editing procedure.

- 1) Press REW to go a little beyond the beginning of the scene onto which you want to dub the new audio, press PLAY to view the recorded tape, then press PAUSE at exactly the point where dubbing should start.
- 2) While holding down A. DUB, press and release PAUSE.
- 3) To begin Audio Dubbing, press PLAY. When the counter reaches "0:00:00", Audio Dubbing stops automatically and the camcorder enters the Audio Dub-Standby mode. To end Audio Dubbing, press STOP.

- Do not press REW or FF during Audio Dub-Standby, or the edit points will not be accurate.
- If the microphone is too close to the TV, or if the TV's volume is too high, whistling or howling may occur.

For Insert Editing/Audio Dubbing

- Insert Editing and Audio Dubbing may not work correctly if the tape contains blank segments, or if the recording speed was changed during the original recording.
- To edit/dub onto a tape, make sure the erase protection tab is in the position that allows recording.
- Do not press STOP during Insert Editing or Audio Dubbing, or the edit points will not be accurate.

TROUBLESHOOTING

Before consulting your JVC dealer, please check the following to see if you can correct the problem yourself.

Vertical white lines appear when shooting a very bright object.

- This sometimes occurs when the contrast between the back-ground and the object is great. It is not a defect of the camcorder.

Bright, crystal-shaped spots appear in the LCD monitor and the viewfinder.

- Sunlight is directly entering the lens. This is not a defect of the camcorder.

Coloured bright spots appear all over the LCD monitor or the viewfinder.

- The LCD monitor and the viewfinder are made with high-precision technology. However, black spots or bright spots of light (red, green or blue) may appear constantly on the LCD monitor or in the viewfinder. These spots are not recorded on the tape. This is not due to any defect of the unit. (Effective dots: more than 99.99 %.)

Animation or Time-Lapse is not available.

- Before recording in the Animation mode at the very beginning of a tape, set the camcorder to the Recording mode for about 5 seconds, so that the tape runs smoothly. Using the Fade-in function at this point is a good way to begin an animated programme (ⓘpg. 15, REC TIME/INT. TIME in SYSTEM MENU).

The tape is running, but there is no playback picture.

- The TV has not been set to its VIDEO mode or channel.
- If A/V connection is used, the TV's VIDEO/TV Switch has not been set to VIDEO.

Playback picture is blurred or interrupted.

- The video heads are dirty or worn out. Consult your nearest JVC dealer for head cleaning or replacement.

The tape stops during fast-forwarding or rewinding.

- The Counter Memory Function has been activated (ⓘpg. 16, "COUNTER MEMORY").

The date and time displays disappear.

- If you remove the power source from the camcorder while the power is on, all settings and selections are erased. Make sure to turn the camcorder's power off before disconnecting the power source.





The tape will not eject.

- The battery pack is running low.
- If the LCD monitor is not open over 60 degrees, the EJECT button **17** does not function.

The camcorder is a microcomputer-controlled device.

External noise and interference (from a TV, a radio, etc.) might prevent it from functioning properly. In such cases, first disconnect its power supply unit (battery pack, AC Adapter, etc.); and then reconnect it and proceed as usual from the beginning.

WARNING INDICATIONS:

 (high) →  →  →  (exhausted) : Displays the battery remaining power level. As the battery power comes close to nil, the battery indicator  blinks (battery power warning). When the battery power is exhausted, power turns off automatically.

 : Blinks when no cassette is loaded, or when the erase protection tab is not in the position that allows recording.

TAPE END: Appears when the tape ends during recording, playback or fast-forwarding.

LENS CAP: Appears for 5 seconds after power is turned on if the lens cap is attached.

 **CONDENSATION OPERATION PAUSED PLEASE WAIT:** These 2 warnings appear alternately every 3 seconds if condensation occurs. In this case, all functions except tape eject and power on/off are disabled. Remove the tape, turn the unit off (without removing the power supply), wait a few minutes for the warnings to clear, and turn it on again.

 **HEAD CLEANING REQUIRED USE CLEANING CASSETTE:** These 2 warnings appear alternately every 3 seconds if dirt is detected on the heads during recording. In this case, use an optional cleaning cassette. If the warning remains after cleaning, consult your nearest JVC dealer.

E01—E06 UNIT IN SAFEGUARD MODE REMOVE AND REATTACH BATTERY: The error indications (E01 — E06) show what type of malfunction has occurred. If an error indication and warning appear, turn the unit off, remove the power supply (battery, etc.) and wait a few minutes for them to clear. When it does, you can resume using the camcorder. If the indication remains, consult your nearest JVC dealer.

CAUTIONS

General Battery Precautions

Please make note of the following rules for battery use. When misused, the batteries can leak or explode.

- 1) **Do not** use any different size of batteries from those specified.
- 2) Be sure to insert batteries in the correct direction.
- 3) **Do not** use rechargeable batteries.
- 4) **Do not** expose the batteries to excessive heat as they can leak or explode.
- 5) **Do not** dispose of the batteries in a fire.
- 6) Remove the batteries from the unit if it is to be stored for an extended period to avoid battery leakage which can cause malfunctions.

Battery Packs

The battery packs are nickel-cadmium or nickel metal-hydride batteries. Before using the supplied battery pack or an optional battery pack, be sure to read the following cautions:

1) To avoid hazard...

- ... **do not** burn.
- ... **do not** short-circuit the terminals.
- ... **do not** modify or disassemble.
- ... use only specified chargers.

2) To prevent damage and prolong service life...

- ... **do not** subject to unnecessary shock.
 - ... avoid repeated charging without fully discharging.
 - ... charge in an environment where temperatures are within the tolerances shown in the chart below. This is a chemical reaction type battery—cooler temperatures impede chemical reaction, while warmer temperatures can prevent complete charging.
 - ... store in a cool, dry place. Extended exposure to high temperatures will increase natural discharge and shorten service life.
 - ... fully charged and then fully discharged the battery every 6 months when storing it over a long period of time.
 - ... remove from charger or powered unit when not in use.
 - It is normal for the battery pack to be warm after charging, or after use.
- Temperature Range Specifications
- | | |
|-----------------|---------------|
| Charging..... | 10°C to 35°C |
| Operation | 0°C to 40°C |
| Storage..... | -10°C to 30°C |
- Recharging time is based on room temperature of 20°C.

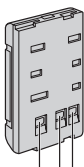

Terminals

- The lower the temperature, the longer recharging takes.

Cassettes

To properly use and store your cassettes:

1) During use...

- ... beware that recording onto prerecorded tapes automatically erases the previously recorded video and audio signals.
- ... make sure the cassette is positioned properly when inserting.
- ... do not load and unload the cassette repeatedly without allowing the tape to run at all. This slackens the tape and can result in damage.
- ... do not open the front tape cover. This exposes the tape to fingerprints and dust.

2) Store cassettes...

- ... away from heaters, other heat sources or direct sunlight.
- ... where they won't be subject to unnecessary shock or vibration.
- ... where they won't be exposed to strong magnetic fields (such as those generated by motors, transformers or magnets).
- ... vertically, in their original cases.

Main Unit

1) For safety, DO NOT...

- ... open the camcorder's chassis.
- ... disassemble or modify the unit.
- ... short-circuit the terminals of the battery pack. Keep it away from metallic objects when not in use.
- ... allow inflammables, water or metallic objects to enter the unit.
- ... remove the battery pack or disconnect the power supply while the power is on.
- ... leave the battery pack attached when the camcorder is not in use.

2) Avoid using the unit...

- ... in places subject to excessive humidity, dust, shock or vibration.
- ... in places subject to soot or steam such as near a cooking stove.
- ... in places subject to excessive shock or vibration.
- ... near a television set.
- ... near appliances generating strong magnetic or electric fields (speakers, broadcasting antennas, etc.).
- ... in places subject to extremely high (over 40°C) or extremely low (under 0°C) temperatures.

3) DO NOT leave the unit . . .

- ... in places of over 50°C.
- ... in places where humidity is extremely low (below 35%) or extremely high (above 80%).
- ... in direct sunlight.
- ... in a closed car in summer.
- ... near a heater.
- ... in dusty places such as a beach.

4) To protect the unit, DO NOT...

- ... allow it to become wet.
- ... drop the unit or strike it against hard objects.
- ... subject it to shock or excessive vibration during transportation.
- ... keep the lens directed at extremely bright objects for long periods.
- ... direct the eyepiece of the viewfinder at the sun.
- ... carry it by holding the viewfinder or the LCD monitor. Be sure to hold the main unit with both hands or use the grip.
- ... swing it excessively when using the shoulder strap.

LCD Monitor**1) To prevent damage to the LCD monitor, DO NOT...**

- ... push it strongly or apply any shocks.
- ... place the camcorder with the LCD monitor on the bottom.

2) To prolong service life...

- ... avoid rubbing it with coarse cloth.

3) Beware of the following phenomena for LCD monitor use. These are not malfunctions:

- While using the camcorder, the surface around the LCD monitor and/or the back of the LCD monitor may heat up.
- If you leave power on for a long time, the surface around the LCD monitor becomes hot.

For Your Maintenance

1) After Use

- ① Turn off the camcorder.
- ② Open the LCD monitor to an angle of over 60 degrees.
Press EJECT for approximately 2 seconds to open the cassette holder, then remove the cassette.
- ③ Close and lock the cassette holder by pressing the Close button.
- ④ Close and lock the LCD monitor.
- ⑤ Slide BATTERY RELEASE to remove the battery pack.
- ⑥ Attach the provided lens cap to the camcorder's lens.

2) Cleaning The Camcorder

- ① Gently wipe the exterior with a soft cloth, with diluted mild soap, wipe off heavy dirt, then wipe again with a dry cloth.
- ② Wipe the LCD monitor gently with a soft cloth. Be careful not to damage the monitor. Close the LCD monitor.

About moisture condensation...

- You may have observed that pouring a cold liquid into a glass will cause drops of water to form on the glass' outer surface. This same phenomenon occurs on the head drum of a camcorder when it is moved from a cool place to a warm place, after heating a cold room, under extremely humid conditions or in a place directly subjected to the cool air from an air conditioner.
- Moisture on the head drum can cause severe damage to the video tape, and can lead to internal damage to the camcorder itself.

Serious malfunctioning

If malfunctioning occurs, stop using the unit immediately and consult your local JVC dealer.

- ③ Blow the lens with a blower brush, then wipe it gently with lens cleaning paper.
 - ④ Remove dust from the viewfinder using a blower brush.
- Avoid using strong cleaning agents such as benzine or alcohol.
 - Cleaning should be done only after the battery pack has been removed or other power units have been disconnected.
 - Mould may form if the lens is left dirty.
 - When using a cleaner or chemically treated cloth, refer to the cautions that came with it.

SPECIFICATIONS

— Camcorder**General****Format** : S-VHS/ VHS PAL standard**Power source** : DC 11 V $\overline{\text{---}}$ (Using AC Adapter)DC 6 V $\overline{\text{---}}$ (Using battery pack)**Power consumption****Viewfinder on** : 3.7 W**LCD monitor on** : 4.3 W**Video light*** : 0.4 W

* GR-SXM301AS only.

Signal system : PAL-type**Video recording system****Luminance** : FM recording**Colour** : Converted sub-carrier direct recording

Conforms to VHS standard

Cassette : **S-VHS** / **VHS** cassette**Tape speed****SP** : 23.39 mm/sec.**LP** : 11.70 mm/sec.**Recording time (max.)****SP** : 60 minutes**LP** : 120 minutes

(with EC-60 cassette)

Operating**temperature** : 0°C to 40°C**Operating humidity** : 35% to 80%**Storage temperature** : -20°C to 50°C**Weight** : Approx. 770 g**Dimensions** : 81 mm x 125 mm x 216 mm
(with the LCD monitor closed
and with the viewfinder fully
tilted downward)**Pickup** : 1/6" format CCD**Lens** : F1.8, f = 2.2 mm to 55 mm,
25:1 power zoom lens with
auto iris and macro control**Filter diameter** : ϕ 30.5mm**Viewfinder** : Electronic viewfinder with
0.24" black/white LCD**White balance****adjustment** : Auto/Manual adjustment**LCD monitor** : 2.50" diagonally measured,
LCD panel/TFT active matrix
system**Speaker** : Monaural**Connectors****Video** : 1 V (p-p), 75 Ω unbalanced,
analogue output (via Video
output connector)**Audio** : 300 mV (rms), 1 k Ω ,
analogue output (via Audio
output connector)**S-Video** : **Y** : 1 V (p-p), 75 Ω , analogue
output**C** : 0.30 V (p-p), 75 Ω ,
analogue output**— AC Adapter****Power requirement:** AC 110 V — 240 V~
50 Hz/60 Hz**Output** : DC 11 V $\overline{\text{---}}$, 1 A

Specifications shown are for SP mode unless otherwise indicated. E & O.E. Design and specifications subject to change without notice.

TERMS

- A**
- AC Adapter pg. 6
 - Animation Recording pg. 15
 - Auto Date Record pg. 15
 - Auto Focus pg. 10
 - Auto Shut Off pg. 9
- B**
- Backlight Compensation pg. 10
 - Battery Pack pg. 6, 19
 - Blue Filter Effect pg. 13
 - Brighten The Image pg. 12
 - Brighten The LCD Monitor pg. 9, 15
- C**
- Cassette Adapter pg. 11
 - Charging The Battery Pack pg. 6
 - Classic Film Effect pg. 13
 - Clean The Camcorder pg. 21
 - Connection To a VCR/ TV pg. 11
 - Counter Memory pg. 16
- D**
- Darken The Image pg. 12
 - Darken The LCD Monitor pg. 9, 15
 - Date/ Time Display pg. 15
 - Date/ Time Settings pg. 7
 - Demonstration Mode pg. 1, 15
 - Digital Effects pg. 13
 - Digital Zoom pg. 14
 - Diopre Adjustment pg. 8
- E**
- Electronic Fog Filter Mode pg. 13
 - Erase Protection pg. 8
 - Exposure Control pg. 12
- F**
- Fade-In/Out pg. 13
 - Fast-Forward Tape pg. 9
 - 5-Second Recording Mode pg. 9
- G**
- Grip Adjustment pg. 8
- H**
- High Speed Shutter Mode pg. 13
- I**
- Instant Titles pg. 14
- L**
- LCD Monitor/ Viewfinder, Indications pg. 4, 5
 - Load A Tape pg. 8
- M**
- Manual Focus pg. 10
 - Menu Screen pg. 12 – 16
 - Monotone Effect pg. 13
 - Mosaic Effect pg. 13
- N**
- ND Effect Mode pg. 13
 - Nega/Posi Mode pg. 13
 - Night-Scope pg. 12
- P**
- Picture Stabiliser pg. 14
 - Playback pg. 9
 - Programme AE with Special Effects pg. 13
 - Provided Accessories pg. 2
- Q**
- Quick Review pg. 10
- R**
- Recording, Start/ Stop pg. 9
 - Recording Format (S-VHS/ S-VHS ET) pg. 16
 - Recording Mode pg. 14
 - Record-Standby pg. 9
 - Red Filter Effect pg. 13
 - Retake pg. 10
 - Rewind The Tape pg. 9
 - Remote Control pg. 17
- S**
- Self-Recording pg. 9
 - Sepia Mode pg. 13
 - Shoulder Strap Attachment pg. 8
 - Snapshot pg. 9
 - Snapshot During Playback pg. 9
 - Solarisation Effect pg. 13
 - Specifications pg. 22
 - Sports Mode pg. 13
 - Still Playback pg. 9
 - Stretch Effect pg. 13
 - Strobe Effect pg. 13
 - Sunset Mode pg. 13
 - Super LoLux (S. LX) pg. 14
 - Super VHS Expansion Technology pg. 16
 - Surf and Snow Mode pg. 13
- T**
- Tape Counter pg. 16
 - Tape Dubbing pg. 11
 - Tape Length Setting pg. 15
 - Tele Macro pg. 14
 - Time Base Corrector pg. 10
 - Time-Lapse Shooting pg. 15, 17
 - Tracking pg. 10
 - Tripod Mounting pg. 8
 - Twilight Mode pg. 13
- U**
- Unload A Tape pg. 8
- V**
- Video Echo Effect pg. 13
 - Video Light pg. 12
 - Viewfinder Adjustment pg. 8
- W**
- White Balance Adjustment pg. 14
 - Wide Mode pg. 14
 - Wipe-In/Out pg. 13
- Z**
- Zooming pg. 10

JVC