



Westinghouse

USER'S MANUAL

MANUAL DEL USUARIO

NB-14w2

Notebook Computer

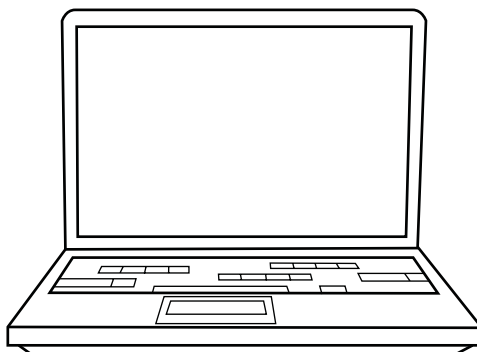

Notice

The information in this user's manual is subject to change without notice.

THE MANUFACTURER OR RESELLER SHALL NOT BE LIABLE FOR ERRORS OR OMISSIONS CONTAINED IN THIS MANUAL AND SHALL NOT BE LIABLE FOR ANY CONSEQUENTIAL DAMAGES, WHICH MAY RESULT FROM THE PERFORMANCE OR USE OF THIS MANUAL.

The information in this user's manual is protected by copyright laws. No part of this manual may be photocopied or reproduced in any form without prior written authorization from the copyright owners.

Copyright 6/2006
All rights reserved.

Microsoft and Windows are registered trademarks of Microsoft Corporation. DOS, Windows 95/98/ME/2000/NT/XP are trademarks of Microsoft Corporation.

Product names mentioned herein may be trademarks and/or registered trademarks of their respective owners/companies.

The software described in this manual is delivered under a license agreement. The software may be used or copied only in accordance with the terms of the agreement.

This product incorporates copyright protection technology that is protected by U.S. patents and other intellectual property rights. Use of this copyright protection technology must be authorized by Macrovision, and is intended for home and other limited viewing uses only unless otherwise authorized by Macrovision. Reverse engineering or disassembly is prohibited.

TABLE OF CONTENTS

PREFACE

Symbols and Conventions

Protecting Your Computer - Avoid Abusive Handling and Adverse Environment

Chapter Summaries

1. GETTING TO KNOW THE BASICS

Performance Features (1-2,3)

System at a Glance (1-4)

Top View (1-4,5)

Front View (1-6)

Side Views (1-7,8,9)

Bottom View (1-10,11)

AC Adapter (1-12)

LED Status Indicators (1-13)

OSD Status Indicators (1-14)

Keyboard Features (1-15)

Function (Quick) Keys (1-15)

Windows Keys (1-16)

Embedded Numeric Keypad (1-16)

Touch Pad (1-17)

Graphic Subsystem (1-18)

Adjusting the Display Brightness (1-18)

Extending the Life of the TFT Display Panel (1-18)

Opening and Closing the Display Panel (1-19)

Audio Subsystem (1-20)

Adjusting the Volume in Windows (1-20)

Voice Recording (1-20)

Modem and Modem Setting (1-21,22)

Ethernet Adapter (1-23)

2. BIOS SETUP AND SECURITY

Entering the BIOS Setup Screen (2-3)

Leaving the BIOS Setup Screen (2-3)

- BIOS Action Keys (2-3)
- Modifying the BIOS Settings (2-4)
 - Main Setup (2-4)
 - Info Setup (2-4)
 - Advance Setup (2-5)
 - Security Setup (2-5,6)
 - Power Setup (2-6)
 - Boot Setup (2-7)
 - Exit Setup (2-8)

3. BATTERY POWER & POWER MANAGEMENT

- The Battery Pack (3-2)
 - Lithium-Ion Battery Technology (3-2)
 - Battery Low-Power Warning (3-3)
- Installing and Removing the Battery Pack (3-4,5)
- Charging the Battery and Charging Time (3-5)
- Checking the Battery Level (3-6)
- Prolonging the Battery's Life and Usage Cycles (3-6)
- Using Windows Power Options (3-7)
 - Windows' Power Schemes (3-7,8)
 - Suspend Modes (3-9,10)
 - Power Button Action (3-11)
 - Low Battery Warning (3-12)
 - Power Manual Quick Access (3-13)

4. TROUBLESHOOTING

- First Step (4-2,3)
- Audio Problems (4-4)
- Hard Disk Problems (4-5,6)
- Optical Drive Problems (4-7)
- Display Problems (4-8)
- Keyboard and Mouse Problems (4-9)
- CMOS Battery Problems (4-10)
- Memory Problems (4-11)
- Modem Problems (4-12)
- Network Adapter / Ethernet Problems (4-13)

Performance Problems (4-14)

Firewire (IEEE1394) and USB2.0 Problems (4-15)

Additional Questions (4-16)

APPENDIX A Product Specification

APPENDIX B Agency Regulatory Notices

Preface

Using This Manual

This User's Manual contains general information about the hardware and software setup, troubleshooting, and technical specifications of the notebook computer.

Symbols and Conventions

The following conventions and symbols are used in this manual:

- When keys are to be pressed at the same time, a plus (+) symbol is used. For instance, Fn+F7 means holding Fn and F7 keys at the same time.
- When a series of clicking actions is needed in Windows O/S, [] and > symbols are used. For instance, [Start > Settings > Control Panel > Display] means clicking the Start icon first, then the Settings, then the Control Panel, then the Display icon.
- When you need to make a selection with the touch pad (or mouse), you will be asked to 'select' or 'click' or 'double-click', 'right-click' the item.



Note: Text in this format and symbol means specific instructions, commentary, sidelights, or any additional information or notes that you should be aware of.



Warning: Text in this format and symbol means that failures to comply with the given instructions or information could result in damage to your computer or could cause bodily harm or loss of life.

Protecting Your Computer - Avoid Abusive Handling and Adverse Environment

Follow the advice below will help ensure that you get the most out of your Investment.

Your computer will serve you well if you take good care of it.

- Do not expose the computer to direct sunlight or place it near sources of heat.
- Do not subject it to temperatures below 0°C (32°F) or above 35°C (95°F).
- Do not expose the computer to magnetic fields.
- Do not expose the computer to moisture or rain.
- Do not spill water or liquid on the computer.
- Do not subject the computer to adverse shock and vibration.
- Do not expose the computer to dust and dirt.
- Do not place objects on top of the computer to avoid damaging the computer.
- Do not place the computer on rocky surfaces.

- Here are some ways of taking care of your AC adapter.
- Do not connect the adapter to any devices other than your computer.
- Do not let water get into the adapter.
- Do not block the ventilation airway of the adapter.
- Keep the adapter in a cool and ventilated place.
- Do not step on the power cord or place heavy objects on top of it.
- Carefully tuck away the power cord and any cables away from pedestrian traffic.
- When unplugging the power cord, do not pull on the cord itself but pull on the plug.

- Keep the adapter away from children.
- The total ampere ratings of the equipment plugged in should not exceed the ampere rating of the cord if you are using an extension cord.
- The total current rating of all equipment plugged into a single wall outlet should not exceed the fuse rating.
- Do not connect other AC adapter to your notebook. This Notebook uses exclusively the AC adapter: Lishin 0335A2065 (65W), Lishin 0335C2065 (65W), Liteon PA-1650-01 (65W), Liteon PA-1650-02 (65W), EPS F10653-A(65W)

When cleaning the computer, observe these steps:

1. Power off the computer and remove the battery pack.
2. Disconnect the AC adapter.
3. Use a soft cloth dampened with water. Do not use liquid or aerosol cleaners.

Contact your dealer or see your service technician if any of the following occurs:

- Computer has been dropped or the body has been damaged.
- Liquid has been spilled into the product.
- The computer does not operate normally.

Cleaning the Ventilation Grills:

It is suggested that you clean the ventilation grills regularly to maintain optimal thermal regulation of the notebook. To do this, you may use a soft brush or a vacuum cleaner (with appropriate head adapter) to remove the dust buildup on the ventilation grills.

Chapter Summaries

The following is a summary of the available chapters and appendices in this manual.

Chapter 1: Getting to Know the Basics

In this chapter, you will learn the basic operations and features of your computer. It gives you a general understanding of the components of your computer.

Chapter 2: BIOS Setup / Security

In this chapter, you will learn how to change various firmware settings and what the settings mean. Also, you will learn how to take advantage of the built-in security feature provided by the BIOS.

Chapter 3: Battery Power & Power Management

In this chapter, you will learn the fundamentals of power management and how to use them to achieve longer battery life.

Chapter 4: Troubleshooting

In this chapter, you will learn how to solve common hardware and software problems.

Appendix A: Product Specification

In this section, you will find a list of the computer's system specifications.

Appendix B: Agency Regulatory Notices

In this section, you will find the general electro-magnetic and safety regulatory information.

C H A P T E R ▼ O N E

GETTING TO KNOW THE BASICS

This chapter introduces the features and components of the computer.

Performance Features

- **High Performance Processor with ATI Radeon Xpress 200M Chipset**

The notebook PC is equipped with a powerful Mobile Intel Celeron M processor. Together with the ATI chipset and integrated graphic technologies, the system offers very advanced PC performances.
- **Wide-Screen LCD Display**

The computer is equipped with a wide-screen 14.1-inch TFT high-resolution display panel for the best cinematic viewing experience.
- **ExpressCard Technology**

ExpressCard (type I, 34mm) is the next-generation of the PC Card standard. The bus interface is based on the two standards: PCI Express for high-performance I/O and USB2.0 for variety of devices.
- **Expandability**

The system offers upgradeable hard disk drive and 2 DDRII SDRAM sockets for expansion, allowing the user to easily increase the storage and system capacities as the need arises.
- **Built-in Multiple Card Reader**

There is built-in 4-in-1 card reader to access many of the portable media formats (SD Card, MS Card, MMC Card, and MS-Pro Card).
- **Ethernet Port**

The system provides built-in 10/100Mbps Ethernet network adapter for high bandwidth network connection.

■ **Firewire (IEEE1394 / 1394a) and USB2.0 ports**

In addition to a full array of built-in I/O ports, the computer offers IEEE1394 for ultra high-speed connection to high bandwidth digital video devices and USB2.0 ports to connect to any USB-based peripheral devices.

■ **Wireless LAN**

The internal Wireless LAN module allows your notebook to connect wirelessly to other 802.11-enabled systems, devices, or network.

System At A Glance

Top View

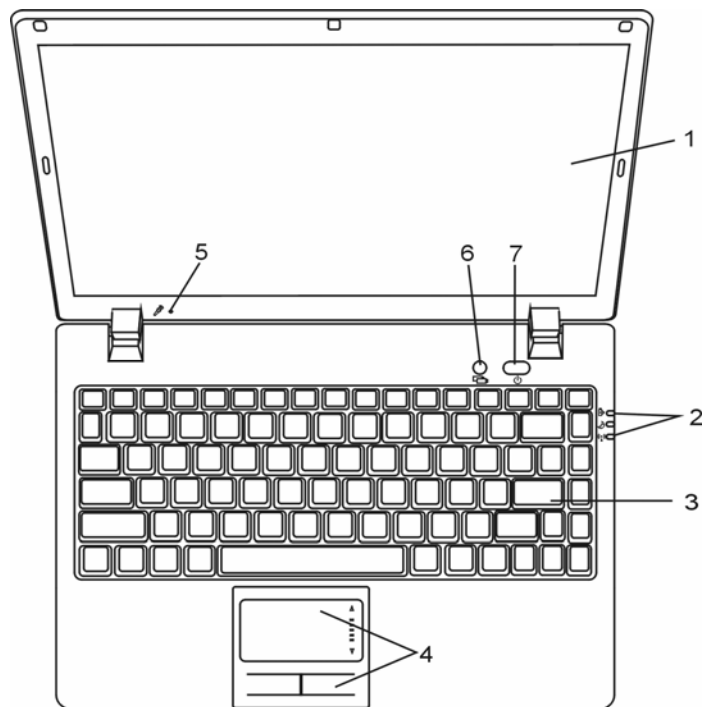

1. LCD Display

The panel is where the system content is displayed.

2. LED Status Indicator

The LED Status indicators reveal the status of the system power state, battery-charging state, Instant-On/Suspend state, and the WLAN switch enabling and disabling. See the LED Status Indicator Section for details.

3. Keyboard

The keyboard is used to enter data. (See Keyboard Section for details.)

4. Touch Pad

The touch pad is a built-in pointing device with functions similar to a mouse.

5. Built-in Microphone

The built-in microphone records sound.

6. Silent Mode Button

When the system is in Windows, pressing the key enables the system to lower its power usage; therefore the fan speed is reduced to achieve lowest operating noise.

When Silent Mode is enabled, the  LED status indicator shows steady green light.

7. Power / Suspend Button

The power/suspend button turns the notebook on and off and it also acts as a system suspend key. Press momentarily to turn on the system. Press and hold for at least 4 seconds to turn off the system. How this key behaves can be defined in [Start > Settings > Control Panel > Power Options > Advanced] menu. Press the power / suspend button again to return from the suspend mode. (See Chapter 3 for more details on system suspend function.)

When the system is in Suspend Mode, the  LED status indicator shows blinking green light.

Front View

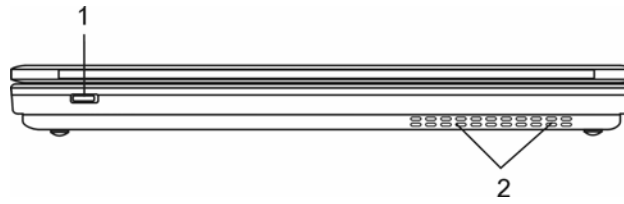

Warning: Do not place any heavy objects on the top of notebook. This may damage the display

1. Wireless On/Off Switch

Use the Switch to disable or enable the Wireless function.

When Wireless LAN function is enabled, the  LED status indicator shows steady blue light.

2. Ventilation Grill

The fan grill is where air is exchanged to dissipate the internal heat. Do not block this airway completely.

Side Views

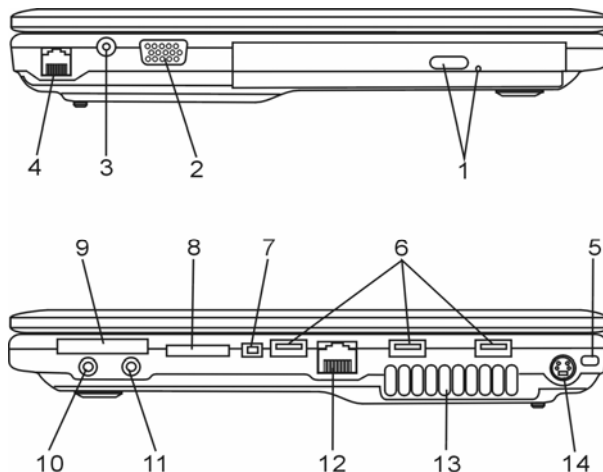

Warning: Do not place any heavy objects on the top of notebook. This may damage the display

1. Optical Drive and Disk Eject Button and Manual Eject Key Hole

If your computer comes with the Combo drive, DVD-Dual, or Super-Multi drive, you may save data onto a CD-R / CD-RW or DVD RW disc. Press the eject button to eject the disk tray. The manual eject keyhole allows you to manually eject a jammed disk.

2. External VGA Port

The VGA video output port is for connecting the external LCD monitor or projector.

3. Power Jack (DC-in)

The DC-out jack of the AC Adapter connects here and powers the computer.

4. Modem Port

This is where you plug the phone jack (RJ-11) for fax/modem functions.

5. Kensington Lock Key Hole

A Kensington-type security lock latches to this keyhole for anti-theft purpose.

6. USB2.0 Port (x3)

The Universal Serial Bus (USB2.0-compliant) port allows you to connect a wide variety of devices to your computer at a rate of up to 480 Mbps. This port conforms to the latest USB2.0 plug-and-play standards.

7. Firewire / IEEE1394 / 1394a Port

This is a high-speed serial data port. You may connect any Fire-wire-ready device to this port.

8. 4-in-1 Card Reader

The 4-in-1 Card Reader supports SD Card, MS Card, MMC Card, and MS-Pro Card.

9. ExpressCard Slot

The slot is where Express Card (Type I, 34mm) is inserted. ExpressCard integrates both the PCI-Express bus technology and USB2.0 interface. Press the card into the slot to insert. Press the card again to eject.

10. Stereo Headphone / SPDIF-out Jack

The stereo headphone jack (3.5-mm diameter) is where you connect the headphones or external speakers. Alternatively, you may connect the SPDIF output to an external DTS, AC3, or PCM sound processor / decoder in your home stereo system.

11. Microphone/Audio Line-in Jack

The microphone/Audio Line-in jack (3.5-mm diameter) is where you connect a microphone or an external audio input source such as a CD player.

12. Ethernet / LAN Port

The port connects to a network hub via the RJ-45 cable and also conforms to 10/100Base-TX transmission protocol.

13. Ventilation Grill

The fan grill is where air is exchanged to dissipate the internal heat. Do not block this airway completely.

14. TV (S-Video) Port

The S-Video port permits you to redirect the screen output to a television set or any analog video playback device. This TV Port is copyright protected; when DVD movie is played, the output is scrambled to prevent analog recording.

For certain configuration, this port does not exist or does not function.

Bottom View

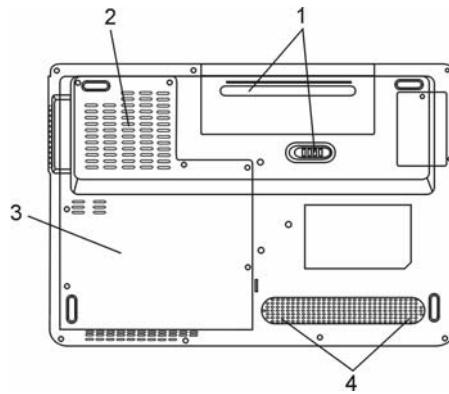

1. Battery Pack and Battery Latch

The battery pack is a built-in power source for the notebook. Slide the battery latch to release the battery pack.

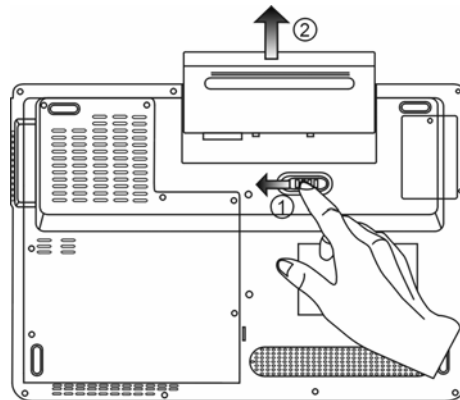

2. Ventilation Grill

The fan grill is where air is exchanged to dissipate the internal heat. Do not block this airway completely.



Warning: Do not block the Fan Grill outlet. Place the machine on hard surface only. The bottom case may get very hot.

3. System Device Cover

The system's processor with cooler assembly, Wireless LAN module, HDD, and DDR memory module are located under the case cover. Note: opening this door will void the warranty.

4. Built-in Stereo Speakers

The built-in speakers output the sound in stereo.

AC Adapter

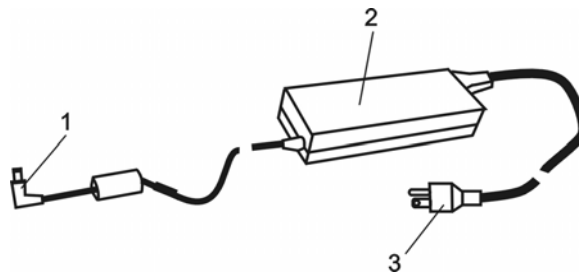

- 1. DC-out Connector**
The DC-out connector docks to the power jack (DC-in) on the computer.
- 2. Adapter**
The adapter converts alternating current into constant DC voltage for the computer.
- 3. AC Plug**
The AC plug connects to the AC wall outlet.

LED Status Indicator

The LED Status Indicator displays the operating status of your notebook. When a certain function is enabled, an LED will light up. The following section describes its indication.

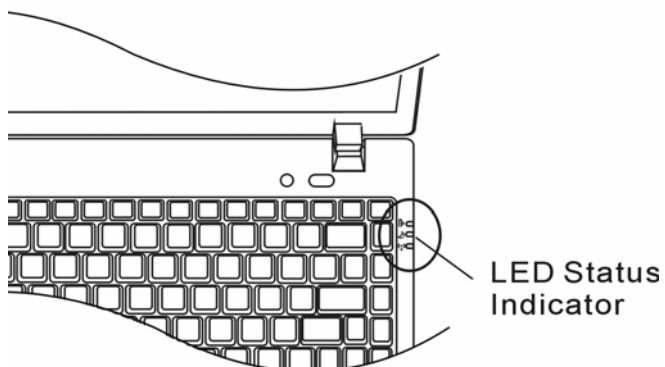





System & Power Status Indicators

LED Graphic Symbol	Indication
	Blue light indicates the WLAN module is active.
	Persistent green light indicates the Silent Mode is enabled. Blinking green light indicates the notebook is in the suspend mode.
	Blinking orange light indicates the battery is being charged. Blinking green light indicates the battery power is low when the system is turned ON. Persistent green light indicates the system is turned ON.

OSD Status Indicator



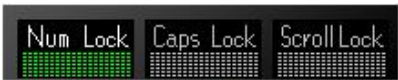



The On-screen Status Display Indicator displays the operating status of your notebook. When a certain function is enabled, the symbol will show up on windows. The following section describes its indication.

OSD Status Indicators

Action	Graphic Symbol
Fn + F3: Audio Mute	
Fn + F5: Audio Volume Up Fn + F6: Audio Volume Down	
Fn + F7: Display Brightness Up Fn + F8: Display Brightness Down	
Fn + Num Lock: Numeric Keypad is	
Caps Lock: Capitalization is On	
Scroll Lock: Scroll Lock is On	

Keyboard Features

Function Keys (Quick Keys)

Graphic Symbol	Action	System Control
	Fn + F1	Enters Suspend Mode.
	Fn + F3	Turns of the battery warning beep off or on.
	Fn + F4	Changes Display Mode: LCD-only, CRT-only and LCD&CRT.
	Fn + F5	Turns Speaker Volume up.
	Fn + F6	Turns Speaker Volume down.
	Fn + F7	Increases Display Brightness.
	Fn + F8	Decreases Display Brightness.
	Fn+Num Lk	Enables the embedded keypad to work in numeric mode. The keys act like numeric keypads in a calculator. Use this mode when you need to do a lot of numeric data entry. An alternative would be to connect an external numeric keypad.
	Caps Lock	When Caps lock is enabled, all the characters you enter become capitalized.
	Fn + Scr Lk	Press the Fn+Scr Lk key and then press ↑ or ↓ to move one line up or down.

Windows Keys

Your keyboard also has two Windows keys:



1. Start Key

This key allows you to pull up the Windows Start Menu at the bottom of the taskbar.



2. Application Menu Key

This key brings up the popup menu for the application, similar to a click of the right mouse button.

Embedded Numeric Keypad

Press Fn + Num Lk to enable the embedded numeric keypad.

The numbers are printed in upper right corner of a key, in a color different from the alphabets. This key pad is complete with arithmetic operators (+, -, *, /).

Press Fn+Num Lk to revert to normal character keys.

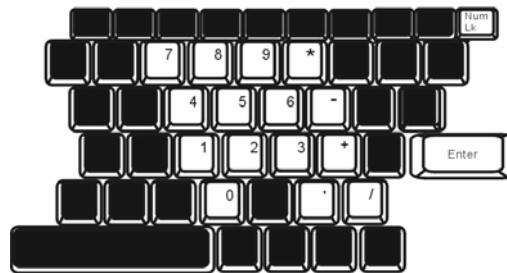

Touch Pad

The built-in touch pad, which is a PS/2-compatible pointing device, senses movement on its surface. As you move your fingertip on the surface of the pad, the cursor responds accordingly.

The following items teach you how to use the touch pad:

1. Move your finger across the touch pad to move the cursor.
2. Press buttons to select or execute functions. These two buttons are similar to the left and right buttons on a mouse. Tapping on the touch pad twice produces is similar to clicking the left button of a mouse.

Function	Left Button	Right Button	Equivalent Tapping Action
Execution	Click twice quickly		Tap twice (at the same speed as double-clicking the mouse button)
Selection	Click once		Tap once
Drag	Click and hold to drag the cursor		Tap twice quickly and on the second tap hold finger to the touch pad to drag the cursor
Access Context Menu		Click once	
Move One Page Up or Down			

Tips on Using the Touch Pad:

1. The double-click speed is timed. If you double-click too slowly, your notebook responds as if you single-clicked twice.
2. Keep your fingers dry and clean when using the touch pad. Also keep the surface of touch pad clean and dry to prolong its life.
3. The touch pad is sensitive to finger movements. Hence, the lighter the touch, the better the response. Heavy touch does not produce better response.

Graphic Subsystem

Your computer uses a high performance 14.1-inch active matrix TFT panel with high resolution and multi-million colors for comfortable viewing. The ATI Radeon Xpress 200M integrated video graphics accelerator, which is Microsoft DirectX 9 compatible, performs graphic rendering at a lighting-fast speed.

Adjusting the Display Brightness

The notebook uses special key combinations, called hot keys, to control brightness.

Press Fn+F7 to increase the brightness.

Press Fn+F8 to decrease the brightness.



Note: To maximize your battery operating time, set the brightness to the lowest comfortable setting, so that the internal backlight uses less power.

Extending the Life of the TFT Display Device

Observe the following guidelines to maximize the life of the backlight in the display.

1. Set the brightness to the lowest comfortable setting (Fn+F8).
2. When working at your desk, connect your notebook to an external monitor and disable the internal display Fn+ F4.
3. Do not disable the suspend time-outs.
4. If you are using AC power and have no external monitor attached, change to suspend mode when not in use.

Opening and Closing the Display Panel

To open the display, lift up the lid. Then tilt it to a comfortable viewing position. The LCD panel has a maximum opening of 135 degrees. Do not push it down forcibly.

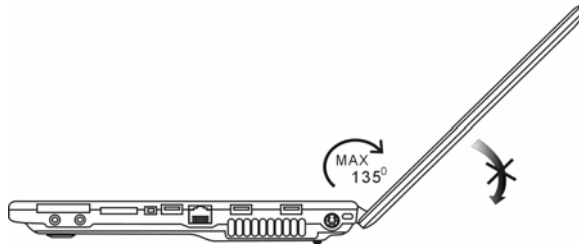

To close the display cover, fold it down gently.



Warning: To avoid damaging the display, do not slam it when closing. Do not place any object on top of the computer when the display is closed

Audio Subsystem

Your computer's audio subsystem is Sound Blaster Pro-compatible.

Adjusting the Volume Manually

To increase the volume, press Fn+F5.

To decrease the volume, press Fn+F6.

Adjusting the Audio Volume in Windows

1. Click the speaker symbol in the task tray in Windows.
2. Drag the volume control bar up or down to adjust the volume.
3. To temporarily silence the speaker without changing the volume setting, click Mute.

Voice Recording

A built-in microphone allows you to record sound. You will need to use audio processing software to enable the built-in microphone. For example, you may use Microsoft Sound Recorder.

Modem

Your computer comes with a 56K V.92 internal fax/modem and a phone jack (RJ-11), which is located on the left side of your computer.

Use a telephone cable to connect the computer to the telephone wall outlet.



Note: For certain configuration, there is no Modem Port or Function.

Connecting the Modem

1. Plug one end of the phone line into the modem port located on the rear side of the computer. (For EMI compliance, you need to clip the included EMI CORE to the phone line.)
2. Plug the other end of the line into the analog phone wall outlet.

Depending on where your computer is used, you may need to change settings in the modem. Correct setting will allow you to maintain a stable connection in a country where its telecommunication system may be different to others.

To change the modem setting, do the following:

1. Go to [Start > Settings > Control Panel > Phone and Modem Options]. Go to *Dialing Rules* and *Edit My Location*. You will see a similar dialog box.

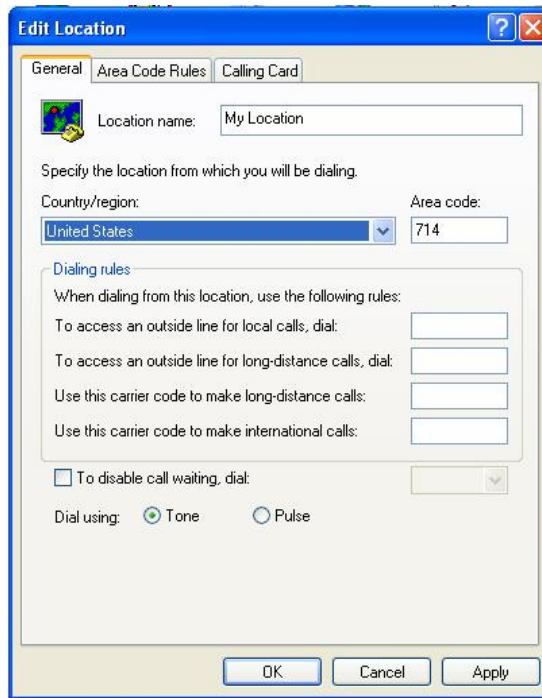

2. Click on the pull-down menu and select the country where it is applicable. Click on OK to exit.

Ethernet

Your computer is equipped with a 10/100Base-TX Fast Ethernet network adapter. Connect the active LAN cable to the RJ-45 LAN port located on the left side of the computer. This allows you to access and transmit data in the local area network.

Connecting to the Network

Use Unshielded Twisted Pair (UTP) Ethernet cable only.

1. Insert one end of the UTP cable into the network connector until the connector snaps securely into the receptacle.
2. Either connect the other end of the cable to an RJ-45 jack wall outlet or to an RJ-45 port on a UTP concentrator or hub in the network.

Cabling Restriction for Networks

The following restrictions should be observed for 10/100BASE-TX networks:

- The maximum cable run length is 100 meters(m) (328 feet[ft]).



Note: Consult Windows manual and / or Novell Netware user's guide for the software installation, configuration, and operation of the network.

C H A P T E R ▼ T W O

BIOS SETUP AND SECURITY FEATURE

In this chapter, you will learn how to enter the BIOS Setup Menu and manipulate various hardware control settings. You will also learn how to use the built-in security features.

The Setup Utility is a hardware configuration program built into your computer's BIOS (Basic Input/Output System). It runs and maintains a variety of hardware functions. It is a menu-driven software, which allows you to easily configure and change the settings.

The BIOS contains manufacture's default settings for the computer's standard operations. However, there are occasions when you may be required to modify the default settings in the BIOS.

The BIOS allows you to set up passwords to limit access to users. This is an important feature because a great deal of vital information is carried within the computer nowadays. Unauthorized access can be prevented. Later in this chapter, you will learn how to use this security feature.

Entering the BIOS Setup Screen

First turn on the power. When the BIOS performs the POST (Power-On Self Test), press F2 key quickly to activate the Phoenix BIOS Setup Utility.



Note: You may need to press F2 key fairly quickly. Once the system begins to load Windows, you may have to retry by cycle-power on again

Leaving the BIOS Setup Screen

When you have finished modifying the BIOS settings, exit the BIOS. It takes a few seconds to record changes in the CMOS.

BIOS Action Keys

Function Key	Command	Description
ESC	Exit	Leaves a sub-menu to return to the previous menu OR exits the BIOS setup while saving changes.
Enter	Go to Sub Screen	Shows the Sub Menu
F1	General Help	Shows the Help Screen
F9	Setup Defaults	Load default values
F10	Save and Exit	Saves changes and reboots the computer.
<Tab>	Select a field	Selects the next field.
↑	Select an item	Selects the next upper item.
↓	Select an item	Selects the next lower item.
-	Lower value	Selects the next value within a field.
+	Higher value	Selects the next value within a field.

Modifying the BIOS Settings

The Phoenix BIOS setup main menu is subdivided into sub-menus. Each menu item is described in this section.

Main Setup

Under this menu, you may change time/date and view basic processor and system memory information.

Item	Selections / Sub-menu	Description
System Time	N/A	Type in the current date, in HH:MM:SS format.
System Date	N/A	Type in the current date, in MM/DD/YY format.

Info Setup

Item	Description
BIOS Information: BIOS Version: 1.00 KBC Version: 1.00 Processor: CPU Type Genuine Intel® CPU CPU Info Intel Celeron M inside	Display BIOS version and CPU Information

Advanced Setup

Item	Selections / Sub-menu	Description
Execute Disable Bit	Disabled Enabled	When enabled, this unique feature protects against certain type of virus that creates Buffer Overflow problem in the memory subsystem.
Quiet Boot	Disabled Enabled	When Disabled, the system will display OEM logo instead of the POST messages. When Enabled, the system will display POST messages (i.e. devices information.)
TouchPad Support	Enabled Disabled	Enable or disable the built-in touchpad.

Security Setup

Item	Selections / Sub-menu	Description
Set Supervisor Password	N/A	Install or Change the Password
Set User Password	N/A	Install or Change the Password
Password on Boot	Disabled Enabled	When enabled, the system will always ask for User Password on boot.

Using Password Protection

Two Levels of Password Protection are available. The BIOS

provides both a Supervisor and a User password. If you try to activate both passwords, the Supervisor password must be set first.

The passwords activate two different levels of protection:

1. System always asks for password every time it is powered on.
2. System asks for password only when you attempt to enter BIOS utility.

The passwords are encrypted and stored in NVRAM. Make sure you write them down or memorize them. If you lost the passwords, the computer may need to be sent back to the factory or to an authorized service dealer to reset the passwords.

Power Setup

Item	Selections / Sub-menu	Description
LCD Panel Power Saving	Enable Disable	When Enabled (system is powered by battery), the system will automatically adjust the LCD brightness to save power.
Long Battery Life Mode	Enable Disable	When Enabled, maximum battery life can be achieved. The processor performance is lowered.



Note: In Windows ME / 98SE / 2000 / XP, suspend mode and settings are determined by settings in the Power Options Properties (Start > Control Panel > Power Options).

Boot Setup

► Boot Settings Configuration

Item	Selections / Sub-menu	Description
LAN Remote Boot	Disabled Enabled	When enabled, the system can support remote wake-up or boot on LAN.

► Boot Device Priority

Item	Selections / Sub-menu	Description
	USB Key USB FDC USB CDROM USB HDD IDE CD IDE HDD PCI BEV Realtek Boot Agent	Set the priority of bootable devices that the BIOS attempts to boot from. For example, if you wish to boot from an external USB CDROM with a bootable disc in it, you may want to put USB CDROM to the top of the priority list.



Note: IDE CD means the system's built-in optical drive. IDE HDD means the system's built-in HDD. PCI BEV is the Realtek Boot Agent, which allows you to boot from the Network.

Note: When the BIOS performs POST, you may also press Enter Key to enable the Boot Device selection menu. You may choose CD/DVD, Hard Drive, or Realtek Boot Agent as the first storage device to boot from. If you have already connected a USB Floppy Disk Drive before powering up, it will appear as a USB FDC in the Boot Device selection menu

Exit Setup

Item	Selections / Sub-menu	Description
Saves Changes and Exit	N/A	After you have completed the BIOS settings, select this item to save all settings, exit BIOS Setup utility, and reboot. New system settings will take effect on next power-up. F10 key can be used for this operation.
Discard Changes and Exit	N/A	Discards changes done so far to any of the setup questions and exit.
Get Default Values	N/A	Load Optimal Default value for all the setup questions. F9 key can be used for this operation.
Load Previous Values	N/A	Load settings that you made during the previous BIOS Setup session.

C H A P T E R ▼ T H R E E

BATTERY POWER & POWER MANAGEMENT

In this chapter, you will learn the fundamentals of power management and how to use it to achieve longer battery life.

In this chapter, you will learn how to operate your notebook on battery power, how to handle and maintain the battery pack, and learn about the system's power saving features.

TFT display, central processor, hard disk drive are the major hardware subsystems that consume the most power. Power management deals how these key components should behave to conserve power. For example, you can have the system turn off its display after 2 minutes of inactivity to save power. Efficient power management can help you work longer sessions before having to recharge the battery.

The Battery Pack

Lithium-Ion Battery

Your notebook uses a six-cell Lithium-Ion battery pack that provides power when you don't have access to an AC outlet.



Note: It is necessary that you charge the battery pack for at least 6 hours before using it for the first time.

Note: In the Standby Suspend mode, a fully charged battery loses its power in roughly 1/2 day or less. When not being used, the battery's power will deplete in 1-2 month.

Battery Low-Power Warning

1. Low Battery Warning
Low battery condition occurs when battery power is reduced to 6%. The green battery status LED indicator blinks and the system beeps once every 16 seconds or so.
2. Very Low Battery Warning
Very Low battery condition occurs at 3 % power remaining. The green battery status LED indicator blinks and the system beeps at 4-second interval.

When the notebook warns you of its low battery condition, you will have about 3-5 minutes to save your current work.



Warning: Do not expose battery packs to temperatures below 0 degree Celsius (32 degree F) or above 60 degree C (140F). This may adversely affect the battery pack.



Note: Press Fn+F3 to turn off the battery warning beep.

Installing and Removing the Battery Pack

To Remove the Battery Pack:

1. Place the notebook bottom-side up on a flat and secured surface.
2. Push the latch and pull the battery's hard case away from the notebook.

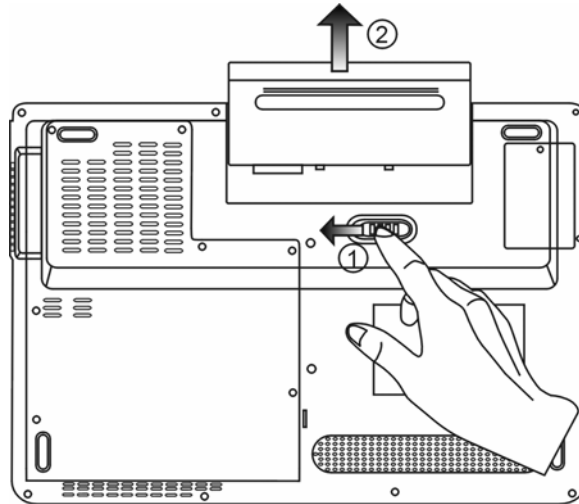

To Install the Battery Pack:

1. Place the notebook bottom-side up on a flat and secured surface.
2. Carefully insert the battery pack into the battery compartment of the notebook.

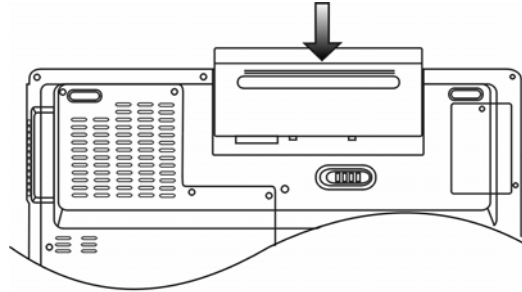

Charging the Battery and Charging Time

To charge the battery, while the battery pack is in the notebook, plug the AC adapter into the notebook and an electrical outlet. The charging time is approximately 4-6 hours when the notebook is turned off and approximately 6-10 hours when the notebook is turned on.

When the battery is fully charged, the battery charge indicator becomes green.



Note: If system runs at heavy loading or in a high temperature environment, the battery may not be fully charged. You need to continue to charge it with the AC adapter plugged in until the charging LED turns green.

Checking the Battery Level

You can check the remaining battery power in the Windows battery status indicator, which is located at the lower right-hand corner of the task bar. (If you do not see a battery or AC-in icon on the task tray, go to Power Options Properties box and click on the Advanced tab. Check off ``Always show icon on the task bar``.)

Alternatively, you can access the power meter by clicking the Power Options icon in the Windows Control Panel.

Prolonging the Battery's Life and Usage Cycles

There are ways you can do to prolong the use of battery.

- Use the AC adapter wherever AC wall outlet is available. This will ensure uninterrupted computing.
- Purchase additional battery pack.
- Store the battery pack in room temperature. Higher temperature tends to deplete the battery's power faster.
- Make good use of the power management function. Save To Disk (Hibernate) saves the most energy by storing current system contents in a hard disk space reserved for this function.
- The life expectancy of the battery is approximately 300 recharges.
- See the notices section in the beginning of the user manual on how to care for the battery pack.

Note: Read Section Protecting Your Notebook in the beginning of this manual for tips about how to maintain the battery pack.

Note: To achieve optimal battery performance, you may need to do a battery calibration at a 3-month interval. To do this:

1. Fully charge the battery.
 2. Then discharge the battery by entering the BIOS setup screen. (Press F2 key as soon as you turn on the computer. And let it remain at the setup screen until the battery runs out.
 3. Fully charge the battery again.
-

Using Windows Power Options

Windows Power Management provides basic power saving features. In the Windows Power Options Properties [Start > Settings > Control Panel > Power Options] dialogue box, you may enter time-out values for display and hard disk drive. Windows power manager saves power by turning off hard drive after 1 minute of inactivity, for example.

Windows' Power Schemes

The power management control panel in Windows XP, known as Power Schemes, is designed to provide the user with an easy-to-use interface. The Power Schemes tab can be found in the Power Options Properties panel that is accessible via the control panel window.

Schemes are easy to understand, based on notebook usage scenarios, and control not only processor power usage but other system peripherals as well.

Go to [Start > Settings > Control Panel] and double-click the Power Options icon.

Always on mode puts the processor into maximum performance mode, which provides no power saving. The other schemes control processor performance based on demand. For example, Max Battery mode lowers the processor's speed and voltage to conserve power as much as possible.

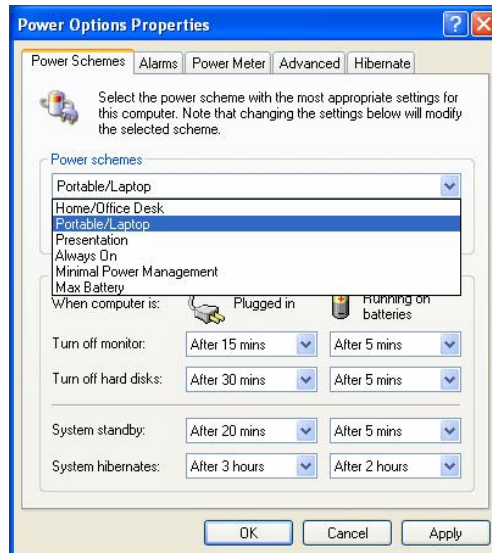

In this dialog box, you can manually set the LCD and hard drive's time-out values in the Plugged in column and in the Running on batteries column. Lower time-out values will save more battery power.



Note: Also consult Windows user guide for more information on how to use Windows power management functions.

Note: Actual dialogue box shown above may appear slightly different.

Suspend Mode

Standby Suspend

The system automatically enters this mode after a period of inactivity, which is set in the Power Schemes dialog box. In Standby mode, hardware devices, such as display panel and hard disk, are turned off to conserve energy.

Hibernate Suspend

In this mode, all system data are saved in the hard disk before powering down. When this mode is activated, all system state and contents are saved to the hard disk drive after a period of inactivity defined by the user. No power or very little power is drawn from the battery module under this mode.

However, depending on how much RAM that have been installed on your computer, the amount of time the system requires to restore all its previous contents can range from 5 to 20 seconds.

For Windows 2000 / XP users, hibernation is handled by the operating system; therefore, no special disk partition or disk file is necessary.

If you wish to activate Hibernate mode, you need enable Hibernate Support in the Hibernate tab of the Power Options menu.



Note: Do not install or remove the memory module when the system is in the suspend mode.

Note: Actual dialogue box shown above may appear slightly different.

Power Button Action

The notebook PC's power button can be set to turn off the system or activate the suspend mode.

Go to [Start > Settings > Control Panel > Power Options] and click on the Advanced tab. In the pull-down menu, select how you wish the power button to work as.

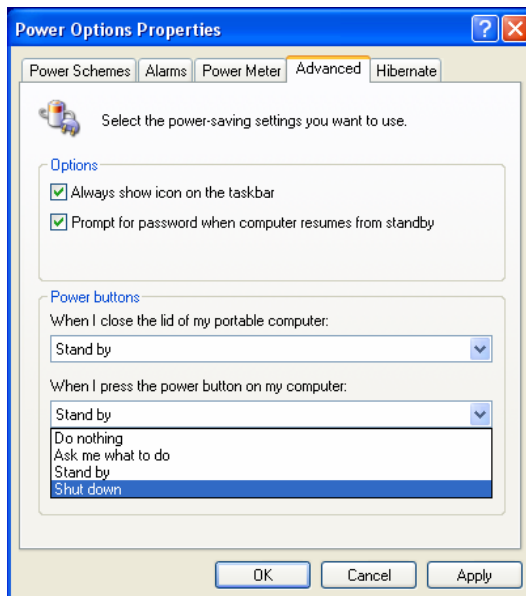

Note: Actual dialogue box shown above may appear slightly different.



Warning: In the *When I close the lid of my portable computer* pull-down menu, DO NOT select *Do nothing* – otherwise the system will still run at high speed while the processor's fan grill is fully blocked by the closed LCD panel. The heat will damage the LCD panel.

Low Battery Warning

You can define when and how the system warns you of its battery-low condition.

Go to the Alarms tab in the Power Options Properties box. If you wish to hear audible beeps, click on the Alarm Action button and put a check on Sound Alarm.

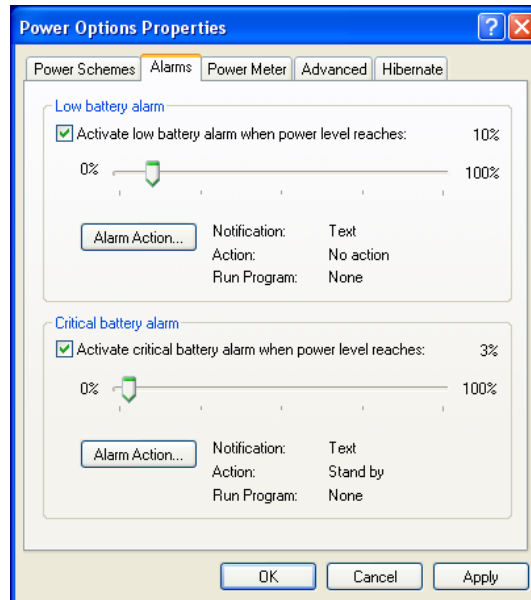

Note: Consult Windows user guide for more information on how to use Windows power management functions.

Note: Actual dialogue box shown above may appear slightly different.

Power Menu Quick Access

Instead of making specific selections in the Power Options Properties box, you can quickly and easily specify which pre-set power saving function you desire by clicking on the Battery icon at the lower right-hand corner of the task bar. (If you do not see a battery or AC-in icon, go to Power Options Properties box and click on the Advanced tab. Check off ``Always show icon on the task bar``.) Select Max Battery if you want the system to enter suspend mode more often. Or, select Always On if your notebook PC is plugged into an AC power source.

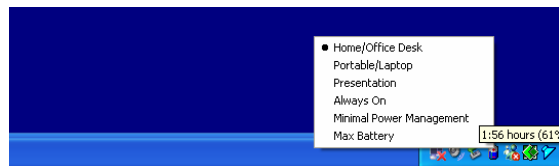

Note: Actual dialogue box shown above may appear slightly different.

C H A P T E R ▼ F O U R

TROUBLESHOOTING

In this chapter, you will learn how to solve common hardware and software problems.

Your computer has been fully tested and complies with the system specifications before shipping. However, incorrect operations and/or mishandling may cause problems.

This chapter provides a reference for identifying and correcting common hardware and software problems that you may encounter.

When you encounter a problem, you should first try to go through the recommendations in this chapter. Instead of returning the computer and waiting for repair, you may easily solve the problems by considering the following scenarios and possible solutions. If the error continues, contact technical support at (866) 287-5555.

Before taking further actions, consider the following suggestions:

- Check to see if the problem persists when all the external devices are removed.
- Check to see that the green light indicator on the AC adapter is lit.
- Check to see the power cord is properly plugged to the wall outlet and to the computer.
- Check to see the power indicator of the computer is on.
- Check to see if your keyboard is operational by pressing and holding any key.
- Check for any incorrect or loose cable connections. Make sure the latches on the connectors latch securely on to the receptor end.
- Be sure you have not performed an incorrect setting on the hardware devices in the BIOS Setup utility. A faulty setting may cause the system to misbehave. If you are not sure of the

changes you made, try to restore all the settings to factory defaults.

- Be sure all the device drivers are installed properly. For example, without the audio driver properly installed, the speakers and microphone will not work.
- If external devices such as USB camera, scanner, and printer do not function correctly when connected to the system, it is usually the device's own problem. Consult the device's manufacturer first.
- Some software programs, which have not gone through rigorous coding and testing, may cause problems during your routine use. Consult the software vendor for problem solving.
- Legacy peripheral are not plug-and-play capable. You need to restart the system with these devices powered up and connected first.
- Be sure to go to BIOS SETUP and load DEFAULT SETTING after BIOS re-flash.
- Contact technical support, 24 hours a day, 7 days a week, at (866) 287-5555.

Audio Problems

No speaker output -

- Software volume control is turned down in Microsoft Sound System or is muted. Double-click the speaker icon on the lower right corner of the taskbar to see if the speaker has been muted or turned down all the way.
- Most audio problems are software-related. If your computer worked before, chances are software may have been set incorrectly.
- Go to [Start > Settings > Control Panel] and double-click the Sounds and Audio Devices icon. In the Audio page, make sure that Realtek HD Audio is the default playback device.

Sound cannot be recorded -

- You will need to plug-in an external microphone to the microphone connector to record sound.
- Double-click the speaker icon on the lower right corner of the taskbar to see if the microphone has been muted.
 1. Click Options and select Properties.
 2. Select Recording and click the OK button.
 3. After Click OK button, the recording volume control panel will appear.
- Go to [Start > Settings > Control Panel] and double-click the Multimedia icon (or Sounds and Audio Devices icon). In the Volume or Audio page, make sure that Realtek HD Audio is the default recording device.

Hard Disk Problems

The hard disk drive does not work or is not recognizable -

- The new HDD may need to be partitioned and reformatted. O/S and drivers will need to be re-installed as well.
- Check the hard disk indicator LED. When you access a file, the LED lamp should light up momentarily.
- The new HDD may be defective or is not compatible.
- If your computer has been subjected to static electricity or physical shock, you may have damaged the disk drive.

The hard drive is making abnormal whining noises -

- You should back up your files as soon as possible.
- Make sure the source of noise is indeed from the hard drive and not the fan or other devices.

The hard disk drive has reached its capacity -

- Run Disk Cleanup utility in Windows. [Start > All Programs > Accessories > System Tools > Disk Cleanup] The system will prompt you for what to do.
- Archive files or programs that you had no longer used by moving them to an alternative storage medium (floppy disk, optical record-able disk, etc.) or uninstall programs that no longer use.
- Many browsers store files in the hard drive as a cache to speed up the performance. Check the program's Online Help for instructions on decreasing the cache size or on removing temporary Internet files.
- Empty the Recycle Bin to create more disk space. When you delete files, Windows saves them to the Recycle Bin.

The hard disk takes longer to read a file -

- If you have been using the drive for a period, the files may be fragmented. Go to [Start > Programs > Accessories > System Tools > Disk Defragmenter] to perform a disk defragmentation. This operation may take a while.
- Interrupt requests or problems with other hardware devices may have occupied the CPU and therefore slows down the system performance.

The files are corrupted -

- Run the Error-checking utility in Windows to check the HDD. Double-click My Computer. Right-click C: and select Properties. Click Check Now in Error-checking in Tools.

Optical Drive Problems

The optical drive does not work -

- Try rebooting the system.
- The disk is damaged or files are not readable.
- After you have inserted a CD-ROM disk, it may take a moment before you can access its content.

The drive does not read any disks -

- The CD may not be properly seated in the tray. Make sure the disk is firmly seated onto the spindle.
- The disk is damaged or not readable.

The disk cannot be ejected -

- Normally, it takes a few seconds to eject the disk.
- If the disk cannot be ejected, it may be mechanically jammed. Straighten out a paper clip and insert it to a tiny hole next to the eject button. This should reject the disk tray. If not, return the unit for repair. Do not forcefully pull on the disk tray.

The Combo or DVD Dual cannot record -

- You need to purchase and install a burner utility program to record files to a blank media.

Display Problems

The display panel is blank when the system is turned on -

- Make sure the computer is not in the Standby or Hibernate suspend modes. The display is turned off to conserve energy in these modes.

The screen is difficult to read -

- The display resolution should at least be set to at least 1024x768 for optimal viewing.
- Go to [Start > Settings > Control Panel] and double-click the Display icon.
- Under the Settings page, set screen resolution to at least 1024x768 and choose at least 256 colors.

The screen flickers -

- It is normal if the display flickers a few times during shutting down or powering up.

Keyboard and Mouse Problems

The built-in touch pad performs erratically

- Make sure there is no excess perspiration or humidity on your hand when using the touch pad. Keep the surface of the touch pad clean and dry.
- Do not rest your palm or wrist on the surface of the touch pad while typing or using the touch pad.

The built-in keyboard accepts no input -

- If you are connecting an external keyboard to the system, the built-in keyboard may not work.
- Try restarting the system.

The characters on the screen repeat while I type.

- You may be holding the keys down too long while you're typing.
- Keep the keyboard clean. Dust and dirt under the keys could cause them to stick.
- Configure the keyboard to wait longer before the auto repeat feature starts. To adjust this feature, Go to [Start > Settings > Control Panel], and double-click the Keyboard icon. A dialogue box shows up with the adjustable settings for the keyboard.

CMOS Battery Problem

A message “CMOS Checksum Failure” displays during the booting process or the time (clock) resets when booting -

- Try to reboot the system.
- If the message “CMOS Checksum Failure” appears during the booting procedure even after rebooting, it may indicate failure of the CMOS battery. Please call our service center for troubleshooting at (866) 287-5555.

Memory Problems

The POST does not show an increased memory capacity when you have already installed additional memory -

- Certain brands of memory module may not be compatible with your system. You should ask your vendor for a list of compatible DIMM.
- The memory module may be defective.

The O/S issues an insufficient memory error message during operation -

- This is often a software or Windows-related problem. A program is draining the memory resources.
- Close the application programs you're not using and restart the system.

Modem Problems

The built-in modem does not respond -

- Make sure the modem driver is loaded properly.
- Go to [Start > Settings > Control Panel > Phone and Modem Options] and go to Modems tab. Make sure Motorola SM56 Data Fax Modem is listed. Otherwise, click the Add button to add the modem drive, which is located in the factory CD-ROM (or floppy diskette).
- Go to [Start > Settings > Control Panel > System] and click Device Manager button in the Hardware page to check for possible resource or driver conflict. See Windows on-line help or manual for how to handle such problems.
- Make sure the phone line, which the computer is connected to, is working.

Connection difficulties -

- Be sure to disable Call Waiting on the phone line.
- Be sure to have the correct country setting where your computer is used. Go to [Start > Settings > Control Panel > Phone and Modem Options]. Go to *Dialing Rules* and *Edit My Location*. In the Country/Region pull-down menu, select the appropriate country setting.
- Excessive line noise might cause the connection to be dropped. To check this, put the regular phone handset on the line and placing a phone call. If you do hear abnormal noise, try to make the modem connection with a different line or contact your local telephony company for service.
- Make sure the cable connection is firm.
- Try a different receiver number and see if the problem persists.

Network Adapter / Ethernet Problems

The Ethernet adapter does not work -

- Go to [Start > Settings > Control Panel > System > Hardware > Device Manager]. Double-click on Network Adapters and check if Realtek RTL8139/810x Family Fast Ethernet NIC appears as one of the adapters. If it does not exist, Windows has not detected the Realtek RTL8139/810x Family Fast Ethernet NIC or the device driver has not been installed properly. If there is a yellow mark or red-cross on the network adapter, it may be a device or resource conflict. Replace or update the device driver from the factory CD-ROM disk or consult Windows manual on how to solve the resource conflict problem.
- Make sure the physical connections on both ends of the cable are good.
- The hub or concentrator may not be working properly. Check to see if other workstations connected to the same hub or concentrator is working.

The Ethernet adapter does not appear to operate in the 100Mbps transmission mode -

- Make sure the hub you are using supports 100Mbps operation.
- Make sure that your RJ-45 cable meets the 100Base-TX requirements.
- Make sure the Ethernet cable is connected to the hub socket that supports 100Base-TX mode. The hub may have both 10Base-TX and 100Base-T sockets.

Performance Problems

The computer becomes hot -

- In a 35°C environment, the certain areas of the computer's back case are expected to reach 50 degrees.
- Make sure the air vents are not blocked.
- If the fan does not seem to be working at high temperature (50 degrees Celsius and up), contact the service center.
- Certain programs that are processor-intensive may increase the computer temperature to a degree where the computer automatically slows down its CPU clock to protect itself from thermal damage.

The program appears stopped or runs very slowly -

- Press CTRL+ALT+DEL to see if an application is still responding.
- Restart the computer.
- This may be normal for Windows when it is processing other CPU-intensive programs in the background or when the system is accessing slow-speed devices such the floppy disk drive.
- You may be running too many applications. Try to close some applications or increase system memory for higher performance.
- The processor may have been overheated due to the system's inability to regulate its internal heat. Make sure the computer's ventilation grills are not blocked.

Firewire (IEEE1394) and USB2.0 Problems

The USB device does not work -

- Windows NT 4.0 does not support USB protocols
- Check the settings in the Windows Control Panel.
- Make sure you have installed the necessary device drivers.
- Contact the device vendor for additional support.

The IEEE1394 port does not work -

- Go to [Start > Settings > Control Panel > System > Hardware > Device Manager]. You should see an entry which reads "OHCI Compliant IEEE 1394 Host Controllers". If it does not exist, Windows has not detected the host controller or the device driver has not been installed properly. If there is a yellow mark or red-cross on the 1394 host controller, it may be a device or resource conflict. Replace or update the device driver from the factory CD-ROM disk or consult Windows manual on how to solve the resource conflict problem.
- Make sure the cable is fully connected.
- Make sure you have installed the necessary device drivers.
- Contact the device vendor for additional support.

Additional Questions

- See our website at www.westinghousedigital.com.
- Contact Westinghouse Digital Customer Service at (866) 287-5555 or write us service@westinghousedigital.com.

A P P E N D I X ▼ A

PRODUCT SPECIFICATION

<ul style="list-style-type: none"> ■ Processor ■ Core Logic

▼ **Processor and Core Logic**

Mobile Intel Celeron M Processor (Yonah), up to 1.73GHz, 1MB L2 cache
 ATI RC410MD + ATI SB460 chipset with graphic, audio, modem, and USB2.0 controllers integrated
 533MHz Front Side Bus
 533 / 667MHz DDR2 interface

<ul style="list-style-type: none"> ■ Memory Type ■ Default ■ Memory Expansion
--

▼ **System Memory**

DDR2 SDRAM 533 / 667
 256 / 512 / 1024MB
 Two 200-pin DIMM sockets, Max 2 GB

<ul style="list-style-type: none"> ■ LCD Panel ■ Graphic Accelerator ■ Motion Playback ■ Other Features

▼ **Display**

14.1-inch Wide-Viewing-Angle WXGA TFT LCD
 ATI RC410MD Integrated Graphic Engine

 Hardware Motion Compensation and IDCT Supported for MPEG1/2 Playback
 DirectX compatible

■ Chipset
■ Audio Codec
■ Sound Capabilities

▼ **Audio**

ATI SB460 integrated audio controller
Realtek Audio Codec
DirectSound 3D, EAX 1.0 & 2.0 compatible
A3D, I3DL2 compatible
AC97 V2.3 compatible
Azalia compatible
2 Stereo Speakers

■ Chipset
■ Transmission Rate

▼ **Modem**

ATI SB460 integrated Modem Controller with MDC card, support 56K MDC Modem Card with Azalia standard
V.92 / V.90 / K56flex for download data speed up to 56Kbps.
V.34, V.17, V.29 protocol supported

■ Module
■ Transmission Protocol

▼ **Wireless LAN**

MSI (RALink) MS-6877 Card
Mini-Card Interface IEEE802.11 B&G

- Chipset
- PnP Function
- Flow Control
- Speed Selection
- Other Features

▼ **LAN / Ethernet**

Realtek RTL8100CL Ethernet function for 10/100Base-TX network standards
 Windows XP Plug and Play compatible
 Automatic Jam and auto-negotiation for flow control
 Auto Negotiation and Parallel detection for automatic speed selection (IEEE 802.3u)
 High performance 32-bit PCI bus master architecture with integrated DMA controller for low CPU and bus utilization
 Remote Wake-up Scheme supported
 Hot Insertion supported

- Chipset
- Capabilities

▼ **Firewire IEEE1394(a)**

02 Micro 0Z128 IEEE1394 OHCI Host Controller
 Up to 400 Mbps
 Expandable up to 63 devices in chains

- Hard Drive
- Combo Drive
- DVD-Dual or DVD-Multi Standards

▼ **Storage**

S-ATA 2.5-inch format hard disk drive

- Keyboard
- Touch pad

▼ **Keyboard & Touch pad**

86/87-key QWERTY keyboard with numeric keypad and Windows keys, 19.05mm Pitch
Built-in Touch Pad

- Chipset
- Express Card / New Card
- 4-in-1 Card Reader Format Support

▼ **ExpressCard (NewCard) & Multiple Card Reader**

02 Micro 0Z128 (Card Reader)
Single Slot, 34mm type I supported

Multimedia Card (MMC), Secure Digital Card (SD), Memory Stick (MS), and MS Pro Card

- Mic-In/Audio-in Port
- Audio-Out/SPDIF
- Firewire
- USB2.0 Port
- Ethernet
- Modem
- S-Video
- Power-In
- VGA Port
- Card Reader
- NewCard Slot

▼ **Ports and Connectors**

One Microphone-in / Line-in jack

One Headphone / SPDIF-out jack

One Firewire (IEEE1394) host connector

Three USB2.0-compliant connectors

One standard network Ethernet connector (RJ-45)

One modem / phone connector (RJ11)

One S-video (TV-out) output connector

One DC-in connector

One 15-pin VGA connector

One 4-in-1 Card Reader slot

One NewCard Slot (type I)

<ul style="list-style-type: none"> ■ Primary Battery Pack ■ Feature ■ Adapter AC-Input / DC-Output

▼ **Battery Pack / AC Adapter**

Li-ion 6-Cell pack, 10.8V / 11.1V x 4000 mAh or
 Li-ion 6-Cell pack, 10.8V / 11.1V x 4400 mAh or
 Li-ion 6-Cell pack, 10.8V / 11.1V x 4800 mAh
 Low battery state with low battery warning beep
 Uniwill SmartPower III Power Management
 Smart Battery Compliant; low battery warning beep
 Long Battery Life Mode and Silent Mode
 Autosensing AC-in 100~240V, DC-out 20V, 65W

<ul style="list-style-type: none"> ■ PnP Function ■ Self Test ■ Auto Detection ■ Power Management ■ Security ■ Other Features

▼ **BIOS**

Phoenix PnP BIOS
 Power On Self Test
 DRAM auto-detection, auto-sizing
 L2 Cache auto-detection
 Hard disk type auto-detection
 APM 1.2 (Advanced Power Management) &
 ACPI 2.0 (Advanced Configuration Power Interface)
 Two Level Password Protections
 32bit access, Ultra DMA, PIO5 Mode support
 Multi-boot capability

<ul style="list-style-type: none"> ■ O/S

▼ **Operating System**

Compatible with Microsoft Windows XP Home Edition / Professional SP2

■ Dimension

■ Weight

■ Environmental
Limits

▼ **Physical Specification**

332 (W) x 232 (D) x 23.5~33.8 (H) mm

2.4KG / 5.28lbs (with 14.1" LCD, DVD-ROM Drive and
6-cell battery pack)

Operating Temperature: 5 to 35°C (41 to 95°F)

Operating Humidity: 20 to 80 percent RH (5 to 35°C)

Storage Temperature: -15 to 50°C (-5 to 122°F)

A P P E N D I X ▼ B

AGENCY REGULATORY NOTICES

Federal Communications Commission Notice

This equipment has been tested and found to comply with the limits for a Class B digital device, pursuant to Part 15 of the FCC Rules. These limits are designed to provide reasonable protection against harmful interference in a residential installation. This equipment generates, uses, and can radiate radio frequency energy and, if not installed and used in accordance with the instructions, may cause harmful interference to radio communications. However, there is no guarantee that interference will not occur in a particular installation. If this equipment does cause harmful interference to radio or television reception, which can be determined by turning the equipment off and on, the user is encouraged to try to correct the interference by one or more of the following measures:

- Reorient or relocate the receiving antenna.
- Increase the separation between the equipment and the receiver.
- Connect the equipment into an outlet on a circuit different from that to which the receiver is connected.
- Consult the dealer or an experienced radio or television technician for help.

Modifications

The FCC requires the user to be notified that any changes or modifications made to this device that are not expressly approved by the Manufacture may void the user's authority to operate the equipment.

Connections to Peripheral Devices

Connections to this device must be made with shielded cables with metallic RFI/EMI connector hoods to maintain compliance with FCC Rules and Regulations.

Declaration of Conformity

This device complies with Part 15(~~CLASS B~~)/68 the FCC Rules. Operation is subject to the following two conditions: (1) this device may not cause harmful interference, and (2) this device must accept any interference received, including interference that may cause undesired operation.

European Notice

Products with the CE Marking comply with both the EMC Directive (89/336/EEC) and the Low Voltage Directive (73/23/EEC) and R&TTE Directive (1999/5/EC) issued by the Commission of the European Community.

Compliance with these directives implies conformity to the following European Norms:

- EN55022 : 1998+A1: 2000+A2: 2003. CLASS B
- EN61000-3-2 : 2000
- EN61000-3-3 : 1995+A1: 2001
- EN55024 : 1998+A1 : 2001+A1: 2003
- IEC61000-4-2: 2001
- IEC61000-4-3:2002+A1:2002
- IEC61000-4-4:1995+A1:2000+A2:2001
- IEC61000-4-5:2001
- IEC61000-4-6:2001
- IEC61000-4-8:2001
- IEC61000-4-11:2001
- EN50082 (IEC801-2, IEC801-3, IEC801-4) Electro-magnetic Immunity
- EN 300 328-2, EN 300 328-1, EN 301 489-1, EN 301 489-17 (ETSI 300 328, ETSI 301 489) Electro-magnetic Compatibility and Radio Spectrum Matter.
- TBR21 (ETSI TBR21) Terminal Equipment.
- EN60950 (IEC60950) I.T.E. Product Safety

Canadian Notice

This digital apparatus does not exceed the Class B limits for radio noise emissions from digital apparatus as set out in the radio interference regulations of the Canadian Department of Communications.

Le present appareil numerique nemet pas de bruits radioelectriques depassant les limites applicables aux appareils numeriques de Classe B prescrites dans le reglement sur le brouillage radioelectrique edicte par le Ministere des Communications du Canada.

REN (Ringer Equivalent Numbers) Statement

"NOTICE: The **Ringer Equivalence Number** (REN) assigned to each terminal device provides an indication of the maximum number of terminals allowed to be connected to a telephone interface. The termination on an interface may consist of any combination of devices subject only to the requirement that the sum of the Ringer Equivalence Numbers of all the devices does not exceed 5."

IC ID: 3409A-M30E10

Attachment Limitations Statement

"Notice: This equipment meets telecommunications network protective, operational and safety requirements as prescribed in the appropriate Terminal Equipment Technical Requirements document(s). This is confirmed by marking the equipment with the Industry Canada certification number. The Department does not guarantee the equipment will operate to the user's satisfaction.

Before installing this equipment, users should ensure that it is permissible to be connected to the facilities of the local telecommunications company. The equipment must also be installed using an acceptable method of connection. The customer should be aware that compliance with the above conditions may not prevent degradation of service in some situations.

Repairs to certified equipment should be coordinated by a representative designated by the supplier. Any repairs or alterations made by the user to this equipment, or equipment malfunctions, may give the telecommunications company cause to request the user to disconnect the equipment.

Users should ensure for their own protection that the electrical ground connections of the power utility, telephone lines and internal metallic water pipe system, if present, are connected together. This precaution may be particularly important in rural areas.

Caution: Users should not attempt to make such connections themselves, but should contact the appropriate electric inspection authority, or electrician, as appropriate."

Power Cord Requirement

The power cord supplied with the AC adapter should match the plug and voltage requirements for your local area. Regulatory approval for the AC adapter has been obtained using the power cord for the local area. However, if you travel to a different area and need to connect to a different outlet or voltage, you should use one of the power cords listed below. To purchase a power cord (including one for a country not listed below) or a replacement ac adapter, contact your local dealer.

U.S. and Canada

- The cord set must be UL-Listed and CSA-Certified or C-UL Listed.
- The minimum specifications for the flexible cord are (1) No. 18 AWG, (2) Type SJ, and (3) 3-conductor.

- The cord set must have a rated current capacity of at least 10 A.
- The attachment plug must be an earth-grounding type with a NEMA 5-15P (15A, 125V) or NEMA 6-15P (15 A, 250V) configuration.

Japan

- All components of the cord set (cord, connector, and plug) must bear a `PSE` mark and registration number in accordance with the Japanese Dentori Law.
- The minimum specification for the flexible cord are: (1) 0.75 mm² conductors, (2) Type VCT or VCTF, and (3) 3-conductor.
- The cord set must have minimum rated current capacity of 7 A.
- The attachment plug must be a two-pole, grounded type with a Japanese Industrial Standard C8303 (15 A, 125 VAC) configuration.

Other Countries

- The cord set fittings must bear the certification mark of the agency responsible for evaluation in a specific country. Acceptable agencies are:
 - BSI (UK)
 - OVE (Australia)
 - CEBEC (Belgium)
 - SEMKO (Sweden)
 - FIMKO (Finland)
 - DEMKO (Denmark)
 - NEMKO (Norway)
 - SETI (Finland)
 - EANSW (Australia)
 - SEV (Switzerland)
 - IMQ (Italy)
 - UTE (France)
 - CCC (China)
 - PSB (Singapore)
 - PSE (Japan)
 - BSMI (Taiwan)
 - B (Polish)
 - VDE (Germany)
 - SASO (Saudi Arabia)
- The flexible cord must be of a HAR (harmonized) type HO5VV-F 3-conductor cord with a minimum conductor size of 0.03 square inches.
- The minimum specification for the flexible cord for Class II product are: (1) 2X0.75 mm² conductors, (2) 2-conductor cord.

- The cord set must have a current capacity of at least 10 A and a nominal voltage rating of 125 / 250 VAC.

CAUTION: MODEL NB-14w2 IS DESIGNED TO USE WITH THE FOLLOWING AC ADAPTER MODEL ONLY

Manufacture: LITE-ON ELECTRONICS, INC

Model: P PA-1650-02 (65W), PA-1650-01 (65W)

Manufacture: LI SHIN INTERNATIONAL ENTERPRISE CORP.

Model: 0335A2065 (65W), 0335C2065 (65W)

Manufacture: EPSF

Model: 10653-A (65W)

Telephone lines requirement

- The appropriate utilization of 26AWG telephone line cord on unit.
CAUTION: Always disconnect all telephone lines from the wall outlet before servicing or disassembling this equipment.
CAUTION: To reduce the risk of fire, use only No. 26AWG or larger telecommunication line cord.

Battery Pack Safety

The battery pack is intended to use only with this notebook.

Do not disassemble the pack.

Do not dispose of the battery pack in fire or water.

To avoid risk of fire, burns, or damage to your battery pack, do not allow a metal object to touch the battery contacts.

Handle a damaged or leaking battery with extreme care. If you come in contact with the electrolyte, wash the exposed area with soap and water. If it contacts the eye, flush the eye with water for 15 minutes and seek medical attention.

Do not charge the battery pack if the ambient temperature exceeds 45°C (113°F).

To obtain a replacement battery, contact your local dealer.

Do not expose the battery pack to high storage temperatures (above 60°C, 140°F).

- When discarding a battery pack, contact your local waste disposal provider regarding local restrictions on the disposal or recycling of batteries.
- Use only supplied AC Adapter for charging.

CAUTION: Danger of explosion if battery is incorrectly replaced. Replace

only with same or equivalent type recommended by the manufacturer.
Discard used batteries according to the manufacturer's instructions or local laws.

VORSICHT! Explosionsgefahr bei unsachgemäßen Austausch der Batterie.
Ersatz nur durch denselben oder einem vom Hersteller empfohlenem
ähnlichen Typ. Entsorgung gebrauchter Batterien nach Angaben des
Herstellers.

Laser Safety

The optical drive used with this computer is certified as a Class 1 laser device according to the U.S. Department of Health and Human Services (DHHS) Radiation Performance Standard and International Standards IEC 825 / IEC 825-1 (EN60825 / EN60825-1). The device is not considered harmful, but the following precautions are recommended:

- Do not open the unit.
- Avoid direct exposure to the laser beam.
- If the unit requires service, contact an authorized service center.
- Ensure proper use by reading and following the instructions carefully.
- Do not attempt to make any adjustment of the unit.

CLASS 1 LASER PRODUCT
APPAREIL A LASER DE CLASSE 1
LASERSCHUTZKLASSE 1 PRODUKT

Warning!

Do not attempt to disassemble the cabinet containing the laser. The laser beam used in this product is harmful to the eyes. The use of optical instruments, such as magnifying lenses, with this product increase the potential hazard to your eyes. For your safety, have this equipment serviced only by an authorized service provider.

Lithium battery warning / Bridge battery warning

This computer contains a lithium battery to power the clock and calendar circuitry.

CAUTION: Danger of explosion if battery is replaced incorrectly. Replace only with the same or equivalent type recommended by the manufacturer.

Discard used batteries according to the manufacturer's instructions.

ATTENTION: Il y a danger d'explosion s'il y a remplacement incorrect de la batterie. Remplacer uniquement avec une batterie du même type ou d'un type recommandé par le constructeur. Mettre au rebut les batteries usagées conformément aux instructions du fabricant.

VORSICHT! Explosionsgefahr bei unsachgemäßen Austausch der Batterie. Ersatz nur durch denselben oder einem vom Hersteller empfohlenen ähnlichen Typ. Entsorgung gebrauchter Batterien nach Angaben des Herstellers.

Der Arbeitsplatzbezogene Schalldruckpegel nach DIN 45 635 beträgt 70dB (A) oder weniger.

Zum Netzanschluss dieses Gerätes ist eine geprüfte Leitung zu verwenden. Für einen Nennstrom bis 6A und einem Gerätegewicht größer 3kg ist eine Leitung nicht leichter als (1)H05VV-F, 3G, 0.75mm² (2)2X0.75 mm² conductors einzusetzen.

Die Steckdose muß nahe dem Gerät angebracht und leicht zugänglich sein.

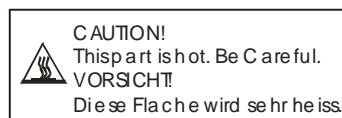

When you see this symbol, be careful as this spot may be very hot.



www.westinghousedigital.com