

# INSPIRON™

## SETUP GUIDE



YOURS IS HERE



# INSPIRON™

## SETUP GUIDE

Model P06S series

Type P06S001

# Notes, Cautions, and Warnings



**NOTE:** A NOTE indicates important information that helps you make better use of your computer.



**CAUTION:** A CAUTION indicates either potential damage to hardware or loss of data and tells you how to avoid the problem.



**WARNING:** A WARNING indicates a potential for property damage, personal injury, or death.

---

Information in this document is subject to change without notice.

© 2009 Dell Inc. All rights reserved.

Reproduction of these materials in any manner whatsoever without the written permission of Dell Inc. is strictly forbidden.

Trademarks used in this text: *Dell*, the *DELL* logo, *Inspiron*, *YOURS IS HERE*, and *DellConnect* are trademarks of Dell Inc.; *Intel* and *Pentium* are registered trademarks and *Core* is a trademark of Intel Corporation in the U.S. and other countries; *Microsoft* and *Windows* are either trademarks or registered trademarks of Microsoft Corporation in the United States and/or other countries; *Blu-ray Disc* is a trademark of the Blu-ray Disc Association; *Bluetooth* is a registered trademark owned by Bluetooth SIG, Inc. and is used by Dell under license.

Other trademarks and trade names may be used in this document to refer to either the entities claiming the marks and names or their products. Dell Inc. disclaims any proprietary interest in trademarks and trade names other than its own.

August 2009

P/N MV909

Rev. A00

# Contents

<b>Setting Up Your Inspiron Laptop</b> . . . . .	<b>5</b>	Computer Base and Keyboard Features . . . . .	22
Before Setting Up Your Computer . . . . .	5	Multimedia Control Keys . . . . .	25
Connect the AC Adapter . . . . .	6	Display Features . . . . .	26
Connect the Network Cable (Optional) . . . . .	7	Dell Extended Battery Life . . . . .	28
Press the Power Button . . . . .	8	Removing and Replacing the Battery . . . . .	28
Set Up Microsoft Windows . . . . .	9	Software Features . . . . .	30
Install the Subscriber Identity Module (Optional) . . . . .	10	Dell Dock . . . . .	32
Enable or Disable Wireless (Optional) . . . . .	12	<b>Solving Problems</b> . . . . .	<b>34</b>
Connect to the Internet (Optional) . . . . .	14	Beep Codes . . . . .	34
<b>Using Your Inspiron Laptop</b> . . . . .	<b>16</b>	Network Problems . . . . .	35
Right View Features . . . . .	16	Power Problems . . . . .	35
Left View Features . . . . .	18	Memory Problems . . . . .	37
Front View Feature . . . . .	20	Lockups and Software Problems . . . . .	38

## Contents

<b>Using Support Tools</b> .....	<b>40</b>	Product Information.....	57
Dell Support Center.....	40	Returning Items for Repair Under Warranty or for Credit.....	58
System Messages.....	41	Before You Call.....	59
Hardware Troubleshooter.....	43	Contacting Dell.....	61
Dell Diagnostics.....	43	<b>Finding More Information and Resources</b> .....	<b>62</b>
<b>Restoring Your Operating System</b> .....	<b>48</b>	<b>Basic Specifications</b> .....	<b>64</b>
System Restore.....	48	<b>Appendix</b> .....	<b>70</b>
Dell Factory Image Restore.....	50	Macrovision Product Notice.....	70
Operating System Reinstallation.....	52	Information para NOM (únicamente para México).....	71
<b>Getting Help</b> .....	<b>54</b>	<b>Index</b> .....	<b>72</b>
Technical Support and Customer Service.....	55		
DellConnect™.....	55		
Online Services.....	56		
Automated Order-Status Service.....	57		

# Setting Up Your Inspiron Laptop

This section provides information about setting up your Inspiron laptop.

## Before Setting Up Your Computer

When positioning your computer, ensure that you allow easy access to a power source, adequate ventilation, and a level surface to place your computer.

Restricting airflow around your Inspiron laptop may cause it to overheat. To prevent overheating, ensure that you leave at least 10.2 cm (4 inches) at the back of the computer and a minimum of 5.1 cm (2 inches) on all other sides. You should never place your computer in an enclosed space, such as a cabinet or drawer when it is powered on.

 **WARNING:** Do not block, push objects into, or allow dust to accumulate in the air vents. Do not place your Dell™ computer in a low-airflow environment, such as a closed briefcase, while it is powered on. Restricting the airflow can damage the computer or cause a fire. The computer turns on the fan when the computer gets hot. Fan noise is normal and does not indicate a problem with the fan or the computer.

 **CAUTION:** Placing or stacking heavy or sharp objects on the computer may result in permanent damage to the computer.

## Connect the AC Adapter

Connect the AC adapter to the computer and then plug it into a wall outlet or surge protector.

**⚠ WARNING:** The AC adapter works with electrical outlets worldwide. However, power connectors and power strips vary among countries. Using an incompatible cable or improperly connecting the cable to a power strip or electrical outlet may cause fire or permanent damage to your computer.

**🔧 NOTE:** Connect the power cord to the adapter firmly and ensure that the light on the adapter is on when you turn on power.

**🔧 NOTE:** Use only Dell AC adapter family PA-2E and PA-12 with your computer.

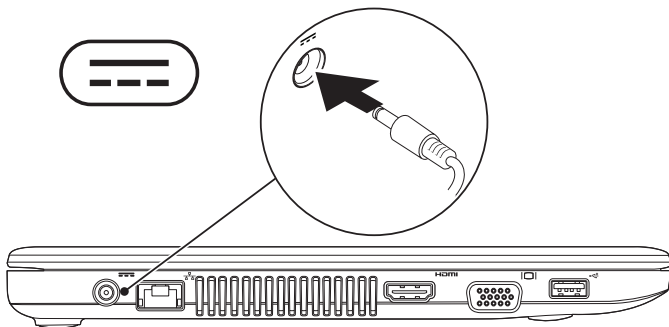



## Connect the Network Cable (Optional)

To use a wired network connection, connect one end of the network cable to the computer, and plug the other end into the wall socket.

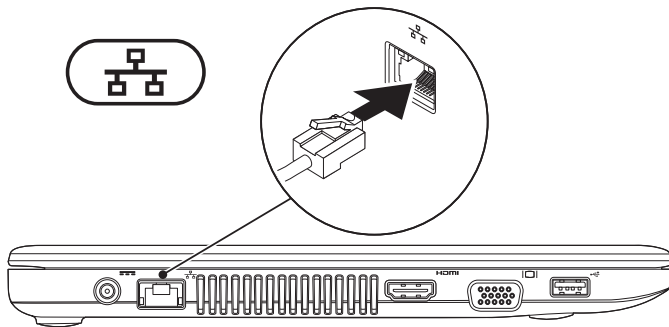

## Press the Power Button

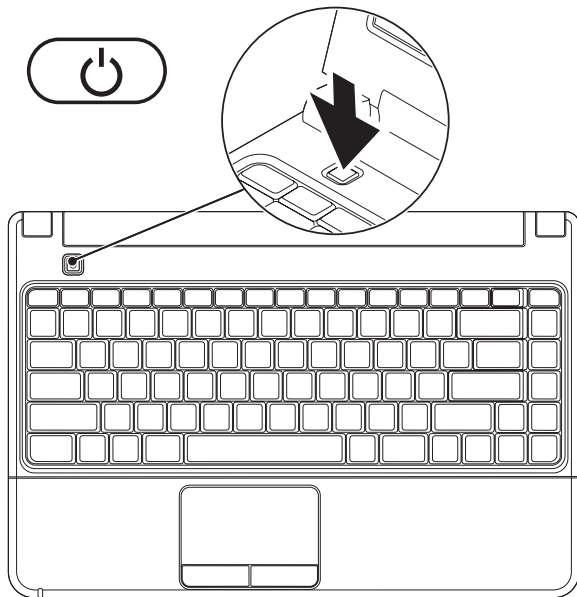

## Set Up Microsoft Windows

Your Dell computer is preconfigured with Microsoft® Windows® operating system. To set up Windows for the first time, follow the instructions on the screen. These steps are mandatory and may take some time to complete. The Windows setup screens will take you through several procedures including accepting license agreements, setting preferences, and setting up an Internet connection.

 **CAUTION:** Do not interrupt the operating system's setup process. Doing so may render your computer unusable and you will need to reinstall the operating system.

 **NOTE:** For optimal performance of your computer, it is recommended that you download and install the latest BIOS and drivers for your computer available at [support.dell.com](http://support.dell.com).

## Install the Subscriber Identity Module (Optional)

 **NOTE:** Installing a Subscriber Identity Module (SIM) is not required if you are using an EVDO card to access the Internet.

Installing a SIM on your computer allows you to connect to the Internet. To access the Internet, you must be within the network of your cellular service provider.

### To install the SIM:

1. Turn off your computer.
2. Remove the battery (see “Removing and Replacing the Battery” on page 28).
3. In the battery bay, slide the SIM into the SIM slot.
4. Replace the battery (see “Removing and Replacing the Battery” on page 28).
5. Turn on your computer.

**1** battery bay

**2** SIM slot

**3** SIM

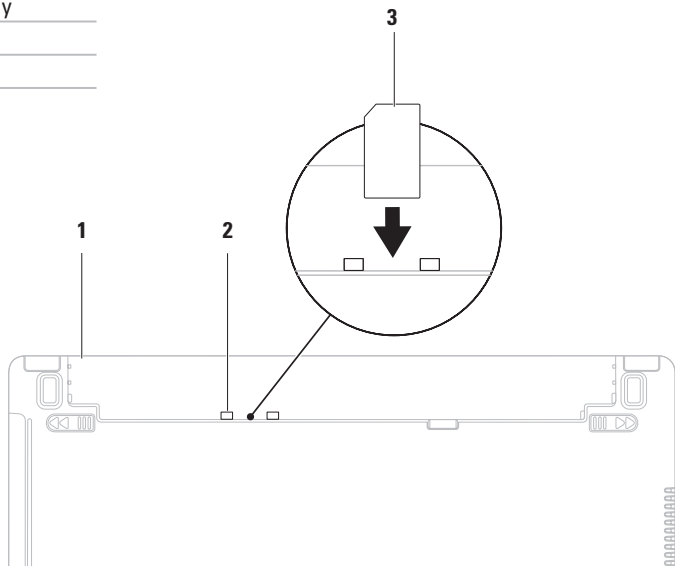

### Enable or Disable Wireless (Optional)

Press the  $\langle \text{A} \rangle$  key or press the  $\langle \text{Fn} \rangle \langle \text{F2} \rangle$  keys on the keyboard to enable or disable wireless. The wireless on or off icons appear on the screen to indicate the status.

 **NOTE:** The wireless feature is available on your computer only if you purchased a WLAN or a Bluetooth card.

Wireless on:

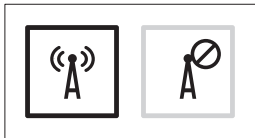

Wireless off:

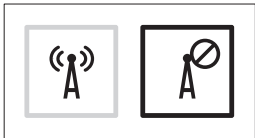

For information on changing the behavior of the Fn key, see “Multimedia Control Keys” on page 25.

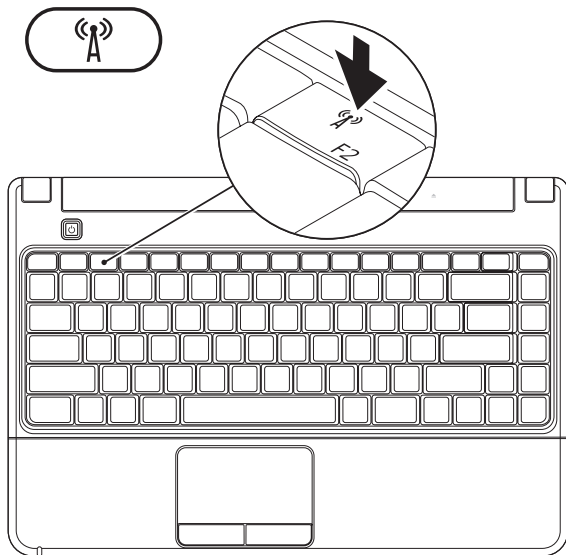

# Connect to the Internet (Optional)

To connect to the Internet, you need an external USB modem or network connection and an Internet Service Provider (ISP).

If an external USB modem or WLAN adapter is not a part of your original order, you can purchase one from the Dell website at [www.dell.com](http://www.dell.com).

## Setting Up a Wired Connection

- If you are using a DSL or cable/satellite modem connection, contact your ISP or cellular telephone service for setup instructions.
- If you are using a dial-up connection, connect the telephone line to the external USB modem and to the telephone wall connector before you set up your Internet connection.

To complete setting up your wired Internet connection, follow the instructions in “Setting Up Your Internet Connection” on page 15.

## Setting Up a Wireless Connection

 **NOTE:** To set up your wireless router, see the documentation that shipped with your router.

Before you can use your wireless Internet connection, you need to connect to your wireless router.

### To set up your connection to a wireless router:

1. Ensure that wireless is enabled on your computer (see “Enable or Disable Wireless” on page 12).
2. Save and close any open files, and exit any open programs.
3. Click  → **Control Panel** → **Network and Sharing Center** → **Connect to a network**.
4. Follow the instructions on the screen to complete the setup.



### Setting Up Your Internet Connection

ISPs and ISP offerings vary by country. Contact your ISP for offerings available in your country.

If you cannot connect to the Internet but have successfully connected in the past, your ISP may have a service outage. Contact your ISP to check the service status. Have your ISP information ready.

If you do not have an ISP, the **Connect to the Internet** wizard can help you find one.

#### To set up your Internet connection:

1. Save and close any open files, and exit any open programs.
2. Click  → **Control Panel** → **Network and Sharing Center** → **Set up a new connection or network** → **Connect to the Internet**.  
The **Connect to the Internet** window appears.

 **NOTE:** If you do not know which type of connection to select, click **Help me choose** or contact your ISP.



3. Follow the instructions on the screen and use the setup information provided by your ISP to complete the setup.

# Using Your Inspiron Laptop

This section provides information about the features available on your Inspiron laptop.

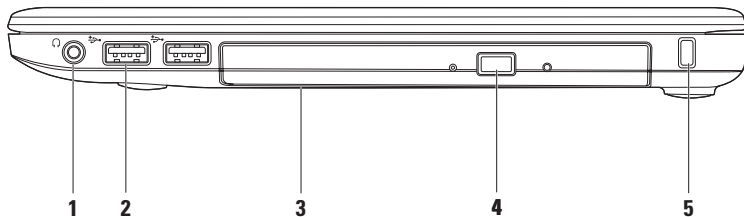
## Right View Features



- 
-  **Audio out/Headphone connector** – Connects one pair of headphones, or sends audio to a powered speaker or sound system.
- 
-  **USB 2.0 connectors (2)** – Connects to USB devices, such as a mouse, keyboard, printer, external drive, or MP3 player.
- 
- Optical drive** – Plays or records CDs, DVDs, or Blu-ray Discs (optional). Ensure that the side with print or writing is facing up when placing a disc in the tray. For more information on using the optical drive, see the *Dell Technology Guide* on your hard drive or at [support.dell.com/manuals](http://support.dell.com/manuals).  
 **CAUTION:** This drive supports nonstandard-sized and -shaped discs; however, degradation in drive performance may be experienced, and in extreme cases, the drive may be damaged.
- 
- Eject button** – Opens the optical drive tray when pressed.
- 
- Security cable slot** – Attaches a commercially available antitheft device to the computer.  
**NOTE:** Before you buy an antitheft device, ensure that it works with the security cable slot on your computer.
-

## Left View Features

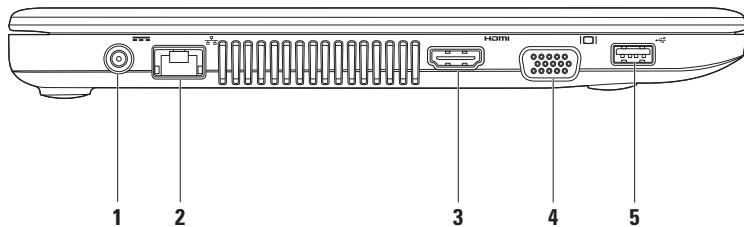

- 
-  **AC adapter connector** – Connects to the AC adapter to power the computer and charge the battery.

---

  -  **Network connector** – Connects to a network or a broadband device if you are using a wired network.

---

  -  **HDMI connector** – Connects to a TV for both 5.1 audio and video signals.  
**NOTE:** When used with a monitor, only the video signal is read.

---

  -  **VGA connector** – Connects to video devices, such as a monitor or a projector.

---

  -  **USB 2.0 connector** – Connects to USB devices, such as a mouse, keyboard, printer, external drive, or MP3 player.
-

## Front View Feature

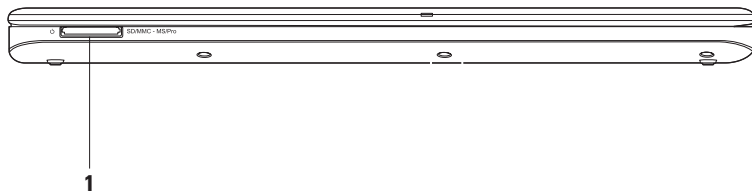

- 1** **SD/MMC - MS/Pro 7-in-1 Memory Card Reader** – Provides a fast, convenient way to view and share digital photos, music, videos, and documents stored on a memory card (see “Basic Specifications” on page 64 for a list of supported cards).

**NOTE:** Your computer ships with a plastic blank installed in the card reader slot. Blanks protect unused slots from dust and other particles. Save the blank for use when no card is installed in the slot; blanks from other computers may not fit your computer.

---

## Computer Base and Keyboard Features

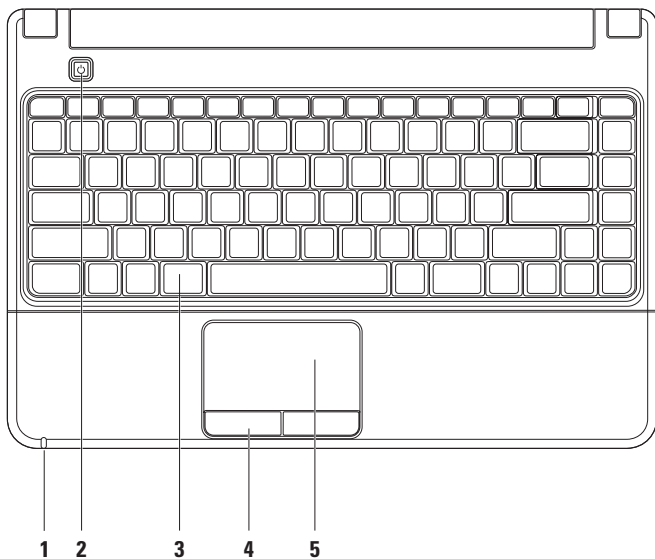



- 1 Power/Battery indicator light** – The light indicates the following states when powered using an AC adapter or a battery.

	Indicator light status	Computer state(s)	Battery charge level
<b>AC Adapter</b>	Solid white	on off/hibernate	n/a <90%
	Blinking white	standby	charging
	off	off/hibernate	>90%
<b>Battery</b>	Solid white	on	>10%
	Blinking white	standby	>10%
	Solid amber	on/standby	<10%
	off	off/hibernate	n/a

**NOTE:** The battery is charging when the computer is powered using an AC adapter.

- 2**  **Power button** – Turns the computer on or off when pressed.

- 3 Keyboard/Multimedia control keys** – For more information about the keyboard, see the *Dell Technology Guide* on your hard drive or at [support.dell.com/manuals](http://support.dell.com/manuals). For more information about the multimedia control keys, see “Multimedia Control Keys” and page 25.
- 
- 4 Touch pad buttons** – Provide left-click and right-click functions like those on a mouse.
- 
- 5 Touch pad** – Provides the functionality of a mouse to move the cursor, drag or move selected items, and right-click or left-click by tapping the surface.
- NOTE:** To change the touch pad settings, double-click the Dell Touch pad icon in the notification area of the desktop.
-

## Multimedia Control Keys

You can configure the multimedia control keys on the keyboard using the **Function Key Behavior** in the **System Setup** (BIOS) utility. The options in the **Function Key Behavior** setting are:

**Multimedia Key First** – This is the default setting. Pressing any multimedia control key performs the associated multimedia action. For function key, press <Fn> + the required function key.

**Function Key First** – Pressing any function key performs the associated function. For multimedia action, press <Fn> + the required multimedia control key.

 **NOTE:** The **Multimedia Key First** option is active only in the operating system.





---

 Mute the sound

---

 Decrease the volume level

---

 Increase the volume level

---

 Play the previous track or chapter

---



---

 Play or pause

---

 Play the next track or chapter

---

 Eject the disc

---

## Display Features

The display panel holds a camera and accompanying digital microphone.

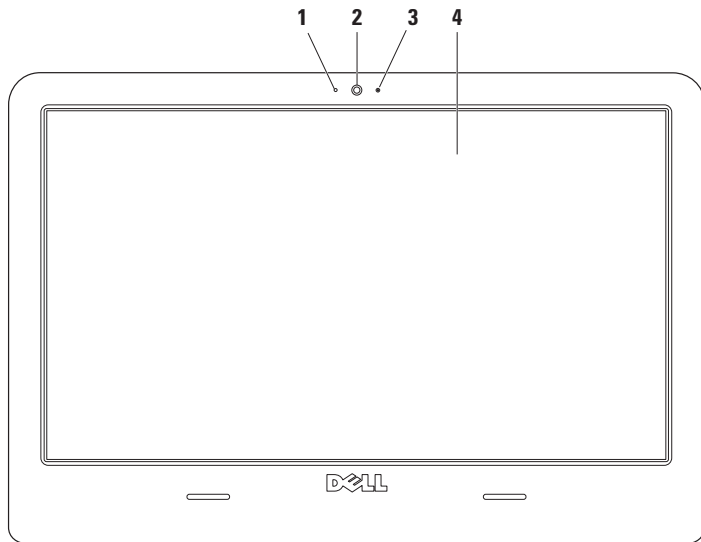

- 
- 1 Digital microphone** – Provides quality sound for audio chatting and voice recording.

---

  - 2 Camera** – Built-in camera for video capture, conferencing, and chat.

---

  - 3 Camera activity indicator** – Indicates if the camera is on or off.

---

  - 4 Display** – Your display can vary based on selections you made when purchasing your computer. For more information about displays, see the *Dell Technology Guide* on your hard drive or at [support.dell.com/manuals](http://support.dell.com/manuals).
-

## Dell Extended Battery Life

The Dell Extended Battery Life feature provides options to maximize your battery's charge. This feature is enabled by default and is activated when you disconnect the AC power.

Press <F3> to enable or disable the feature. The **Extended Battery Life** pop-up appears to indicate the current status.

### To learn more about the customization options for Dell Extended Battery Life:

1. Press <F3>. The **Extended Battery Life** pop-up appears.
2. Click **Show Settings**. The **Battery Meter** window appears.
3. Click **What is Dell Extended Battery Life?**

## Removing and Replacing the Battery

 **WARNING:** Using an incompatible battery may increase the risk of fire or explosion. This computer should only use a battery purchased from Dell. Do not use batteries from other computers.

 **WARNING:** Before removing the battery, shut down the computer, and remove external cables (including the AC adapter).

### To remove the battery:

1. Shut down the computer and turn it over.
2. Slide the battery release latches away from each other.
3. Lift the battery out of the battery bay.

### To replace the battery:

1. Place the battery into the battery bay.
2. Click the battery into place.

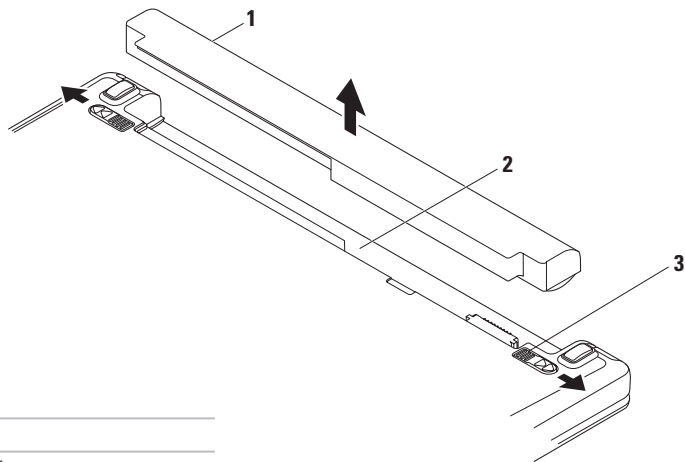

---

**1** battery

---

**2** battery bay

---

**3** battery release latches (2)

## Software Features

 **NOTE:** For more information about the features described in this section, see the *Dell Technology Guide* on your hard drive or at [support.dell.com/manuals](http://support.dell.com/manuals).

### Productivity and Communication

You can use your computer to create presentations, brochures, greeting cards, fliers, and spreadsheets. You can also edit and view digital photographs and images. Check your purchase order for software installed on your computer.

After connecting to the Internet, you can access websites, setup an e-mail account, and upload or download files.

### Entertainment and Multimedia

You can use your computer to watch videos, play games, create your own CDs/DVDs, and listen to music or Internet radio stations. Your optical disc drive may support multiple disc media formats including CDs, DVDs, and Blu-ray Discs (optional).

You can download or copy pictures and video files from portable devices, such as digital cameras and cell phones. Optional software applications enable you to organize and create music and video files that can be recorded to disc, saved on portable products such as MP3 players and handheld entertainment devices, or played and viewed directly on connected TVs, projectors, and home theater equipment.



## Customizing the Desktop

You can use the customizing options available in your operating system to change the appearance, resolution, wallpaper, screensaver, or other features on your desktop.

1. Right-click an open area of the desktop.
2. Click **Personalize**, to open the **Change the visuals and sounds on your computer** window and learn more about your customization options.

## Customizing Your Energy Settings

You can use the power options in your operating system to configure the power settings on your computer. The Microsoft® Windows® operating system installed on your Dell computer provides two default options:

- **Power saver** — Saves power on your computer by reducing system performance to maximize the life of the computer and by reducing the amount of energy consumed by your computer over its lifetime.

- **Balanced (recommended)** — Automatically balances the performance of your computer by consuming energy on capable hardware.

## Transferring Information to a New Computer

1. Click  → **Control Panel** → **Getting Started** → **Transfer files from another computer**.
2. Follow the instructions on the **Windows Easy Transfer** wizard.

## Backing Up Your Data

It is recommended that you periodically back up files and folders on your computer. To back up files:

1. Click  → **Control Panel** → **Back Up and Restore**.
2. Click **Set up backup...**
3. Follow the instructions on the **Configure Backup** wizard.

# Dell Dock

The Dell Dock is a group of icons that provide easy access to frequently-used applications, files, and folders. You can personalize the Dock by:

- Adding or removing icons
- Grouping related icons into categories
- Changing the color and location of the Dock
- Changing the behavior of the icons



## Add a Category

1. Right-click the Dock and click **Add**→ **Category**.  
The **Add/Edit Category** window appears.
2. Enter a title for the category in the **Title** field.
3. Select an icon for the category from the **Select an image:** box.
4. Click **Save**.

## Add an Icon

Drag and drop the icon to the Dock or a category.

## Remove a Category or Icon

1. Right-click the category or icon on the Dock and click **Delete shortcut** or **Delete category**.
2. Follow the instructions on the screen.

## Personalize the Dock

1. Right-click the Dock and click **Advanced Setting....**
2. Choose the desired option to personalize the Dock.

# Solving Problems

This section provides troubleshooting information for your computer. If you cannot solve your problem using the following guidelines, see “Using Support Tools” on page 40 or “Contacting Dell” on page 61.

## Beep Codes

Your computer might emit a series of beeps during start-up if there are errors or problems. This series of beeps, called a beep code, identifies a problem. Write down the beep code and contact Dell (see “Contacting Dell” on page 61).

Beep Code	Possible Problem
One	Possible motherboard failure - BIOS ROM checksum failure
Two	No RAM detected <b>NOTE:</b> If you installed or replaced the memory module, ensure that the memory module is seated properly.
Three	Possible motherboard failure - Chipset error
Four	RAM read/write failure
Five	Real Time Clock failure
Six	Video card or chip failure
Seven	Processor failure
Eight	Display failure

## Network Problems

### Wireless connection is lost —

- Check your wireless router to ensure it is powered on and connected to your cable modem or network hub.
- Interference may be blocking or interrupting your wireless connection. Try moving the computer closer to your wireless router.
- Re-establish your connection to the wireless router (see “Setting Up a Wireless Connection” on page 14).

### Wired connection is lost —

- Make sure the cable is plugged in and not damaged.
- If the problem persists, contact your network administrator or ISP.

## Power Problems

### Power light is off — computer is either turned off, in hibernate state, or not receiving power

- Press the power button to resume normal operation.
- Check that the AC adapter cable is securely plugged into both the power connector on the computer and the electrical outlet.
- If the AC adapter is plugged into a power strip, make sure the power strip is plugged into an electrical outlet and the power strip is turned on.
- Bypass any power protection devices, power strips, and power extension cables to verify that the computer turns on properly.
- Check that the electrical outlet is working by testing it with another device, such as a lamp.
- Check the AC adapter cable connections. If the AC adapter has a light, ensure that the light on the AC adapter is on.

## Solving Problems

### **Power light is solid white but computer is not responding —**

- Display may not be responding. Press the power button until the computer turns off and then turn it back on.

### **Power light is blinking white — standby mode**

- Move the mouse, touch the touch pad, or press the power button to resume normal operation.

### **Power light is solid amber — standby mode with a low battery charge**

- Connect the AC adapter to charge the battery.
- Move the mouse, touch the touch pad, or press the power button to resume normal operation.

### **Possible causes of interference hindering your computer reception —**

- Power, keyboard, and mouse extension cables
- Too many devices connected to a power strip
- Multiple power strips connected to the same electrical outlet

## Memory Problems

### Insufficient memory message —

- Save and close any open files and exit any open programs you are not using to see if that resolves the problem.
- See the software documentation for minimum memory requirements. If necessary, install additional memory (see the *Service Manual* at [support.dell.com/manuals](http://support.dell.com/manuals)).
- Reseat the memory modules (see the *Service Manual* at [support.dell.com/manuals](http://support.dell.com/manuals)) to ensure that your computer is successfully communicating with the memory.

### Other memory problems —

- Ensure that you are following the memory installation guidelines (see the *Service Manual* at [support.dell.com/manuals](http://support.dell.com/manuals)).
- Check if the memory module is compatible with your computer. Your computer supports DDR3 memory. For more information about the type of memory supported by your computer, see “Basic Specifications” on page 64.
- Run the Dell Diagnostics (see “Dell Diagnostics” on page 43).
- Reseat the memory modules (see the *Service Manual* at [support.dell.com/manuals](http://support.dell.com/manuals)) to ensure that your computer is successfully communicating with the memory.

## Lockups and Software Problems

### Computer does not start up —

- Check that the AC adapter cable is firmly connected to the computer and to the electrical outlet.

### A program stops responding —

End the program:

1. Press <Ctrl><Shift><Esc> simultaneously.
2. Click **Applications**.
3. Click the program that is no longer responding
4. Click **End Task**.

### A program crashes repeatedly —

Check the software documentation. If necessary, uninstall and then reinstall the program.



**NOTE:** Software usually includes installation instructions in its documentation or on the CD.

### Computer stops responding or a solid blue screen appears —



**WARNING:** You might lose data if you are unable to perform an operating system shutdown.

- If you are unable to get a response by pressing a key on your keyboard or moving your mouse, press the power button for at least 8 to 10 seconds until the computer turns off and then restart your computer.



**A program is designed for an earlier Microsoft® Windows® operating system —**

Run the **Program Compatibility** wizard. The **Program Compatibility** wizard configures a program so that it runs in an environment similar to an earlier version of Microsoft Windows operating system environments.

1. Click .
2. In the search box, type `Use an older program with this version of Windows` and press <Enter>.
3. Follow the instructions on the **Program Compatibility** wizard.

**Other software problems —**

Back up your files immediately.

Use a virus-scanning program to check the hard drive or CDs.

Save and close any open files or programs and shut down your computer through the Start  menu.

Check the software documentation or contact the software manufacturer for troubleshooting information:

- Ensure that the program is compatible with the operating system installed on your computer.
- Ensure that your computer meets the minimum hardware requirements needed to run the software. See the software documentation for information.
- Ensure that the program is installed and configured properly.
- Verify that the device drivers do not conflict with the program.
- If necessary, uninstall and then reinstall the program.

# Using Support Tools

## Dell Support Center

The **Dell Support Center** helps you find the service, support, and system-specific information you need.

To launch the application, click the  icon in the taskbar.

The **Dell Support Center** home page displays your computer's model number, service tag, express service code, and service contact information.

The home page also provides links to access:

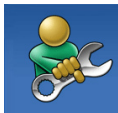

**Self Help** (Troubleshooting, Security, System Performance, Network/Internet, Backup/Recovery, and Windows operating system)



**Alerts** (technical support alerts relevant to your computer)



**Assistance from Dell** (Technical Support with DellConnect™, Customer Service, Training and Tutorials, How-To Help with Dell on Call, and Online Scan with PC CheckUp)



**About Your System** (System Documentation, Warranty Information, System Information, Upgrades & Accessories)

For more information about **Dell Support Center** and available support tools, click the **Services** tab at [support.dell.com](http://support.dell.com).

## System Messages

If your computer has an issue or error, it may display a System Message that will help you identify the cause and action needed to resolve the issue.

 **NOTE:** If the message you received is not listed in the following examples, see the documentation for either the operating system or the program that was running when the message appeared. Alternatively you could see the *Dell Technology Guide* on your hard drive or at [support.dell.com/manuals](http://support.dell.com/manuals) or see “Contacting Dell” on page 61 for assistance.

**Alert! Previous attempts at booting this system have failed at checkpoint [nnnn]. For help in resolving this problem, please note this checkpoint and contact Dell Technical Support** —

The computer failed to complete the boot routine three consecutive times for the same error. Contact Dell for assistance (see “Contacting Dell” on page 61).

**CMOS checksum error** — Possible motherboard failure or Real Time Clock (RTC) battery low. Replace the RTC coin-cell battery (see the *Service Manual* at [support.dell.com/manuals](http://support.dell.com/manuals)) or contact Dell for assistance (see “Contacting Dell” on page 61).

**CPU fan failure** — CPU fan has failed. Replace the CPU fan (see the *Service Manual* at [support.dell.com/manuals](http://support.dell.com/manuals)).

**Hard-disk drive failure** — Possible hard disk drive failure during POST. Contact Dell for assistance (see “Contacting Dell” on page 61).

**Hard-disk drive read failure** — Possible hard disk drive failure during HDD boot test. Contact Dell for assistance (see “Contacting Dell” on page 61).

**Keyboard failure** — Keyboard failure or loose cable.

Replace the keyboard (see the *Service Manual* at [support.dell.com/manuals](http://support.dell.com/manuals)).

## Using Support Tools

**No boot device available** — No bootable partition on hard disk drive, the hard disk drive cable is loose, or no bootable device exists.

- If the hard drive is your boot device, ensure that the cables are connected and that the drive is installed properly and partitioned as a boot device.
- Enter system setup and ensure that the boot sequence information is correct (see the *Dell Technology Guide* at [support.dell.com/manuals](http://support.dell.com/manuals)).

**No timer tick interrupt** — A chip on the system board might be malfunctioning or motherboard failure. Contact Dell for assistance (see “Contacting Dell” on page 61).

**USB over current error** — Disconnect the USB device. Your USB device needs more power for it to function properly. Use an external power source to connect the USB device, or if your device has two USB cables, connect both of them.

**NOTICE - Hard Drive SELF MONITORING SYSTEM has reported that a parameter has exceeded its normal operating range. It is recommended that you back up your data regularly. A parameter out of range may or may not indicate a potential hard drive problem** — S.M.A.R.T error, possible hard disk drive failure. Contact Dell for assistance (see “Contacting Dell” on page 61).

## Hardware Troubleshooter

If a device is either not detected during the operating system setup or is detected but incorrectly configured, you can use the **Hardware Troubleshooter** to resolve the incompatibility.

### To start the Hardware Troubleshooter:

1. Click  → **Help and Support**.
2. Type `hardware troubleshooter` in the search field and press <Enter> to start the search.
3. In the search results, select the option that best describes the problem and follow the remaining troubleshooting steps.

## Dell Diagnostics

If you experience a problem with your computer, perform the checks in “Lockups and Software Problems” on page 38 and run the Dell Diagnostics before you contact Dell for technical assistance.

 **NOTE:** Dell Diagnostics works only on Dell computers.

 **NOTE:** The *Drivers and Utilities* disc is optional and may not ship with your computer.

See the System Setup section in the *Service Manual* to review your computer's configuration information, and ensure that the device that you want to test appears in the system setup program and is active.

Start the Dell Diagnostics from your hard drive or from the *Drivers and Utilities* disc.

### Starting Dell Diagnostics From Your Hard Drive

The Dell Diagnostics is located on a hidden diagnostic utility partition on your hard drive.

 **NOTE:** If your computer cannot display a screen image, contact Dell for assistance (see “Contacting Dell” on page 61).

1. Ensure that the computer is connected to an electrical outlet that is known to be working properly.
2. Turn on (or restart) your computer.
3. When the DELL™ logo appears, press <F12> immediately. Select **Diagnostics** from the boot menu and press <Enter>.

 **NOTE:** If you wait too long and the operating system logo appears, continue to wait until you see the Microsoft® Windows® desktop; then, shut down your computer and try again.

 **NOTE:** If you see a message stating that no diagnostics utility partition has been found, run the Dell Diagnostics from the *Drivers and Utilities* disc.

*If Pre-boot System Assessment (PSA) is invoked:*

- a. The PSA starts running tests.
- b. If the PSA completes successfully, the following message appears: “No problems have been found with this system so far. Do you want to run the remaining memory tests? This will take about 30 minutes or more. Do you want to continue? (Recommended).”

- c. If you are experiencing memory issues, press <y>, otherwise press <n>. The following message appears: "Booting Dell Diagnostic Utility Partition. Press any key to continue."
- d. Press any key to go to the **Choose An Option** window.

*If PSA is not invoked:*

Press any key to start the Dell Diagnostics from the diagnostics utility partition on your hard drive.

4. Select the test you want to run.
  5. If a problem is encountered during a test, a message appears with an error code and a description of the problem. Write down the error code and problem description and contact Dell for assistance (see "Contacting Dell" on page 61).
-  **NOTE:** The Service Tag for your computer is located at the top of each test screen. The Service Tag helps you identify your computer when you contact Dell.
6. When the tests are complete, close the test screen to return to the **Choose An Option** window.
  7. To exit the Dell Diagnostics and to restart the computer, click **Exit**.

### Starting Dell Diagnostics From the Drivers and Utilities Disc

1. Insert the *Drivers and Utilities* disc.
2. Shut down and restart the computer.  
When the DELL™ logo appears, press <F12> immediately.

 **NOTE:** If you wait too long and the operating system logo appears, continue to wait until you see the Microsoft® Windows® desktop; then, shut down your computer and try again.

 **NOTE:** The next steps change the boot sequence for one time only. On the next start-up, the computer boots according to the devices specified in the system setup program.

3. When the boot device list appears, highlight **CD/DVD/CD-RW** and press <Enter>.
4. Select the **Boot from CD-ROM** option from the menu that appears and press <Enter>.
5. Type **1** to start the CD menu and press <Enter> to proceed.
6. Select **Run the 32 Bit Dell Diagnostics** from the numbered list. If multiple versions are listed, select the version appropriate for your computer.
7. Select the test you want to run.
8. If a problem is encountered during a test, a message appears with an error code and a description of the problem. Write down the error code and problem description and contact Dell for assistance (see “Contacting Dell” on page 61).



 **NOTE:** The Service Tag for your computer is located at the top of each test screen. The Service Tag helps you identify your computer when you contact Dell.

9. When the tests are complete, close the test screen to return to the **Choose An Option** window.
10. To exit the Dell Diagnostics and restart the computer, click **Exit**.
11. Remove the *Drivers and Utilities* disc.

# Restoring Your Operating System

You can restore your operating system in the following ways:

- System Restore returns your computer to an earlier operating state without affecting data files. Use System Restore as the first solution for restoring your operating system and preserving data files.
- Dell Factory Image Restore returns your hard drive to the operating state it was in when you purchased the computer. This procedure permanently deletes all data on the hard drive and removes any programs installed after you received the computer. Use Dell Factory Image Restore only if System Restore did not resolve your operating system problem.
- If you received an Operating System disc with your computer, you can use it to restore your operating system. However, using the Operating System disc also deletes all data on the hard drive. Use the disc only if System Restore did not resolve your operating system problem.

## System Restore

The Windows operating systems provide a System Restore option which allows you to return your computer to an earlier operating state (without affecting data files) if changes to the hardware, software, or other system settings have left the computer in an undesirable operating state. Any changes that System Restore makes to your computer are completely reversible.

 **CAUTION:** Make regular backups of your data files. System Restore does not monitor your data files or recover them.

## Starting System Restore

1. Click .
2. In the search box, type `System Restore` and press <Enter>.

 **NOTE:** The **User Account Control** window may appear. If you are an administrator on the computer, click **Continue**; otherwise, contact your administrator to continue the desired action.

3. Click **Next** and remaining prompts on the screen.

In the event that System Restore did not resolve the issue, you may undo the last system restore.

## Undoing the Last System Restore

 **NOTE:** Before you undo the last system restore, save and close all open files and exit any open programs. Do not alter, open, or delete any files or programs until the system restoration is complete.

1. Click .
2. In the search box, type `System Restore` and press <Enter>.
3. Click **Undo my last restoration** and click **Next**.

# Dell Factory Image Restore

 **WARNING:** Using Dell Factory Image Restore permanently deletes all data on the hard drive and removes any programs or drivers installed after you received your computer. If possible, back up the data before using this option. Use Dell Factory Image Restore only if System Restore did not resolve your operating system problem.

 **NOTE:** Dell Factory Image Restore may not be available in certain countries or on certain computers.

Use Dell Factory Image Restore only as the last method to restore your operating system. This option restores your hard drive to the operating state it was in when you purchased the computer. Any programs or files added since you received your computer—including

data files—are permanently deleted from the hard drive. Data files include documents, spreadsheets, e-mail messages, digital photos, music files, and so on. If possible, back up all data before using Dell Factory Image Restore.



## Starting Dell Factory Image Restore

1. Turn on the computer. When the DELL™ logo appears, press <F8> several times to access the **Advanced Boot Options** window.

 **NOTE:** If you wait too long and the operating system logo appears, continue to wait until you see the Microsoft® Windows® desktop; then, shut down your computer and try again.

2. Select **Repair Your Computer**.

3. The **System Recovery Options** window appears.

4. Select a keyboard layout and click **Next**.
5. To access the recovery options, log on as a local user. To access the command prompt, type `administrator` in the **User name** field, then click **OK**.
6. Click **Dell Factory Image Restore**. The **Dell Factory Image Restore** welcome screen appears.
  -  **NOTE:** Depending upon your configuration, you may need to select **Dell Factory Tools**, then **Dell Factory Image Restore**.
7. Click **Next**. The **Confirm Data Deletion** screen appears.
  -  **NOTE:** If you do not want to proceed with Factory Image Restore, click **Cancel**.

8. Select the checkbox to confirm that you want to continue reformatting the hard drive and restoring the system software to the factory condition, then click **Next**.

The restore process begins and may take five or more minutes to complete. A message appears when the operating system and factory-installed applications have been restored to factory condition.

9. Click **Finish** to reboot the system.

# Operating System Reinstallation

## Before You Begin

If you are considering reinstalling the Windows operating system to correct a problem with a newly installed driver, first try using the Roll Back Driver feature in Windows. If this feature does not resolve the problem, then use System Restore to return your operating system to the operating state it was in before you installed the new device driver. See “System Restore” on page 48.

 **CAUTION:** Before performing the installation, back up all data files on your primary hard drive. For conventional hard drive configurations, the primary hard drive is the first drive detected by the computer.

**To reinstall Windows, you need the following:**

- Dell *Operating System* disc
- Dell *Drivers and Utilities* disc

 **NOTE:** The *Drivers and Utilities* disc contains drivers that were installed during the assembly of the computer. Use the Dell *Drivers and Utilities* disc to load any required drivers. Depending on the region from which you ordered your computer, or whether you requested the disc, the Dell *Drivers and Utilities* disc and *Operating System* disc may not ship with your computer.

## Reinstalling Microsoft Windows

The reinstallation process can take 1 to 2 hours to complete. After you reinstall the operating system, you must also reinstall the device drivers, virus protection program, and other software.

1. Save and close any open files and exit any open programs.
2. Insert the *Operating System* disc.
3. Click **Exit** if the **Install Windows** message appears.
4. Restart the computer.
5. When the DELL™ logo appears, press <F12> immediately.

 **NOTE:** If you wait too long and the operating system logo appears, continue to wait until you see the Microsoft® Windows® desktop; then, shut down your computer and try again.

 **NOTE:** The next steps change the boot sequence for one time only. On the next start-up, the computer boots according to the devices specified in the system setup program.

6. When the boot device list appears, highlight **CD/DVD/CD-RW Drive** and press <Enter>.
7. Press any key to **Boot from CD-ROM**. Follow the instructions on the screen to complete the installation.

## Getting Help

If you experience a problem with your computer, you can complete the following steps to diagnose and troubleshoot the problem:

1. See “Solving Problems” on page 34 for information and procedures that pertain to the problem your computer is experiencing.
2. See the *Dell Technology Guide* for more troubleshooting information.
3. See “Dell Diagnostics” on page 43 for procedures on how to run Dell Diagnostics.
4. Fill out the “Diagnostic Checklist” on page 60.
5. Use Dell’s extensive suite of online services available at Dell Support ([support.dell.com](http://support.dell.com)) for help with installation and troubleshooting procedures. See “Online Services” on page 56 for a more extensive list of Dell Support online.
6. If the preceding steps have not resolved the problem, see “Before You Call” on page 59.

 **NOTE:** Call Dell Support from a telephone near or at the computer so that the support staff can assist you with any necessary procedures.

 **NOTE:** Dell’s Express Service Code system may not be available in all countries.

When prompted by Dell’s automated telephone system, enter your Express Service Code to route the call directly to the proper support personnel. If you do not have an Express Service Code, open the **Dell Accessories** folder, double-click the **Express Service Code** icon, and follow the directions.

 **NOTE:** Some of the services are not always available in all locations outside the continental U.S. Call your local Dell representative for information on availability.



## Technical Support and Customer Service

Dell's support service is available to answer your questions about Dell hardware. Our support staff use computer-based diagnostics to provide fast, accurate answers.

To contact Dell's support service, see "Before You Call" on page 59 and then see the contact information for your region or go to **[support.dell.com](http://support.dell.com)**.

## DellConnect™

DellConnect is a simple online access tool that allows a Dell service and support associate to access your computer through a broadband connection, diagnose your problem and repair it all under your supervision. For more information, go to **[www.dell.com/dellconnect](http://www.dell.com/dellconnect)**.

### Online Services

You can learn about Dell products and services on the following websites:

- **www.dell.com**
- **www.dell.com/ap** (Asian/Pacific countries only)
- **www.dell.com/jp** (Japan only)
- **www.euro.dell.com** (Europe only)
- **www.dell.com/la** (Latin American and Caribbean countries)
- **www.dell.ca** (Canada only)

You can access Dell Support through the following websites and e-mail addresses:

#### Dell Support websites

- **support.dell.com**
- **support.jp.dell.com** (Japan only)
- **support.euro.dell.com** (Europe only)
- **supportapj.dell.com** (Asia Pacific only)

#### Dell Support e-mail addresses

- **mobile\_support@us.dell.com**
- **support@us.dell.com**
- **la-techsupport@dell.com** (Latin America and Caribbean countries only)
- **apsupport@dell.com** (Asian/Pacific countries only)

#### Dell Marketing and Sales e-mail addresses

- **apmarketing@dell.com** (Asian/Pacific countries only)
- **sales\_canada@dell.com** (Canada only)

#### Anonymous file transfer protocol (FTP)

- **ftp.dell.com**  
Log in as user: `anonymous`, and use your e-mail address as your password.

## Automated Order-Status Service

To check on the status of any Dell products that you have ordered, you can go to **support.dell.com**, or you can call the automated order-status service. A recording prompts you for the information needed to locate and report on your order. For the telephone number to call your region, see “Contacting Dell” on page 61.

If you have a problem with your order, such as missing parts, wrong parts, or incorrect billing, contact Dell for customer assistance. Have your invoice or packing slip handy when you call. For the telephone number to call for your region, see “Contacting Dell” on page 61.

## Product Information



If you need information about additional products available from Dell, or if you would like to place an order, visit the Dell website at **www.dell.com**. For the telephone number to call for your region or to speak to a sales specialist, see “Contacting Dell” on page 61.

## Returning Items for Repair Under Warranty or for Credit

Prepare all items being returned, whether for repair or credit, as follows:

 **NOTE:** Before you return the product to Dell, make sure to back up any data on the hard drive and on any other storage device in the product. Remove any and all confidential, proprietary and personal information, as well as removable media, such as CDs and PC Cards. Dell is not responsible for any of your confidential, proprietary or personal information; lost or corrupted data; or damaged or lost removable media that may be included with your return.

1. Call Dell to obtain a Return Material Authorization Number, and write it clearly and prominently on the outside of the box. For the telephone number to call for your region, see “Contacting Dell” on page 61.
2. Include a copy of the invoice and a letter describing the reason for the return.
3. Include a copy of the Diagnostics Checklist (see “Diagnostic Checklist” on page 60), indicating the tests that you have run and any error messages reported by the Dell Diagnostics (see “Dell Diagnostics” on page 43).
4. Include any accessories that belong with the item(s) being returned (power cables, software, guides, and so on) if the return is for credit.

5. Pack the equipment to be returned in the original (or equivalent) packing materials.
  -  **NOTE:** You are responsible for paying shipping expenses. You are also responsible for insuring any product returned, and you assume the risk of loss during shipment to Dell. Collect On Delivery (C.O.D.) packages are not accepted.
  -  **NOTE:** Returns that are missing any of the preceding requirements will be refused at Dell's receiving dock and returned to you.

## Before You Call

-  **NOTE:** Have your Express Service Code ready when you call. The code helps Dell's automated-support telephone system direct your call more efficiently. You may also be asked for your Service Tag (located on the back or bottom of your computer).

Remember to fill out the following Diagnostics Checklist. If possible, turn on your computer before you call Dell for assistance and call from a telephone at or near the computer. You may be asked to type some commands at the keyboard, relay detailed information during operations, or try other troubleshooting steps possible only at the computer itself. Ensure that the computer documentation is available.

### Diagnostic Checklist

- Name:
- Date:
- Address:
- Phone number:
- Service Tag (bar code on the back or bottom of the computer):
- Express Service Code:
- Return Material Authorization Number (if provided by Dell support technician):
- Operating system and version:
- Devices:
- Expansion cards:
- Are you connected to a network? Yes/No
- Network, version, and network adapter:
- Programs and versions:

See your operating system documentation to determine the contents of the computer's start-up files. If the computer is connected to a printer, print each file. Otherwise, record the contents of each file before calling Dell.

- Error message, beep code, or diagnostic code:
- Description of problem and troubleshooting procedures you performed:

## Contacting Dell

For customers in the United States, call 800-WWW-DELL (800-999-3355).

 **NOTE:** If you do not have an active Internet connection, you can find contact information on your purchase invoice, packing slip, bill, or Dell product catalog.

Dell provides several online and telephone-based support and service options. Availability varies by country and product, and some services may not be available in your area.

**To contact Dell for sales, technical support, or customer service issues:**

1. Visit **support.dell.com**.
2. Verify your country or region in the **Choose A Country/Region** drop-down menu at the bottom of the page.
3. Click **Contact Us** on the left side of the page.
4. Select the appropriate service or support link based on your need.
5. Choose the method of contacting Dell that is convenient for you.

# Finding More Information and Resources

**If you need to:****See:**

---

reinstall your operating system

the Operating System disc

---

run a diagnostic program for your computer, reinstall computer system software, or update drivers for your computer, and readme files

the *Drivers and Utilities* disc



**NOTE:** Drivers and documentation updates can be found at **support.dell.com**.

---

learn more about your operating system, maintaining peripherals, RAID, Internet, Bluetooth<sup>®</sup>, networking, and e-mail

the *Dell Technology Guide* installed on your hard drive or at **support.dell.com/manuals**

---

upgrade your computer with new or additional memory, or a new hard drive  
reinstall or replace a worn or defective part

the *Service Manual* at **support.dell.com/manuals**



**NOTE:** In some countries, opening and replacing parts of your computer may void your warranty. Check your warranty and return policies before working inside your computer.

---



### If you need to:

---

find safety best practices information for your computer  
review Warranty information, Terms and Conditions (U.S. only), Safety instructions, Regulatory information, Ergonomics information, and End User License Agreement

---

find your Service tag/Express Service Code — You must use the service tag to identify your computer on **support.dell.com** or to contact technical support

---

find drivers and downloads  
access technical support and product help  
check on your order status for new purchases  
find solutions and answers to common questions  
locate information for last-minute updates about technical changes to your computer or advanced technical-reference material for technicians or experienced users

---

### See:

---

the safety and regulatory documents that shipped with your computer and also see the Regulatory Compliance Homepage at **www.dell.com/regulatory\_compliance**

---

the back or bottom of your computer

---

the Dell Support website at **support.dell.com**

---

# Basic Specifications

## System Model

---

Dell Inspiron 1370

This section provides information that you may need when setting up, updating drivers for, and upgrading your computer. For more detailed specifications, see the *Comprehensive Specifications* at [support.dell.com/manuals](http://support.dell.com/manuals).



**NOTE:** Offerings may vary by region.

For more information regarding the configuration of your computer, click  → **Help and Support** and select the option to view information about your computer.

## Processor

---

Type	Intel® Pentium® Intel Core™2 Solo Intel Core2 Duo
------	---

## Computer Information

---

System chipset	Intel GS45 + ICH9M SFF
----------------	------------------------

## Camera

---

Pixel	1.3 megapixel
Video Resolution	160 x 120 ~1280 x 1024 (160 x 120 ~ 640 x 480 at 30 fps)

## 7-in-1 Memory Card Reader

---

Memory card controller	Realtek RTS5159
Memory card connector	7-in-1 combo card connector
Flash cards supported	Secure Digital (SD) SD High-Density (SDHD) SD High-Capacity (SDHC) MultiMediaCard (MMC) <i>MMCplus</i> xD-Picture Card Memory Stick Memory Stick Pro

## Memory

---

Memory module connector	two user-accessible SODIMM connectors
Memory module capacities	2 GB, 3 GB, 4 GB, 6 GB
Memory type	DDR3 1067 MHz

 **NOTE:** For instructions on upgrading memory, see the *Service Manual* at [support.dell.com/manuals](http://support.dell.com/manuals).

## Basic Specifications

### Connectors

---

Audio	one stereo headphone/speaker connector
Mini-Card	one Type IIIA full Mini-Card slot, one half-size Mini-Card slot
HDMI connector	19-pin
Network adapter	RJ45 connector
USB	three 4-pin USB 2.0-compliant connectors
Video	15-hole connector

### Communications

---

Modem (optional)	External V.92 56K USB Modem
Network adapter	10/100/1000 Ethernet LAN on system board
Wireless	WLAN, WWAN, and Bluetooth® wireless technology

### Display

---

Type	13.3" HD WLED backlight, TrueLife
Height	189.25 mm (7.45 inches)
Width	306.8 mm (12.08 inches)
Diagonal	336.6 mm (13.25 inches)

**Battery***4-cell lithium ion*

Depth	32.2 mm (1.26 inches)
Height	20.87 mm (0.82 inches)
Width	270.4 mm (10.64 inches)
Weight	0.23 kg (0.5 lb)
Charge time (approximate)	1 hour to 80% capacity and 2 hours to 100% capacity (when the computer is turned off)
Life span (approximate)	300 charge/discharge cycles

**Battery***8-cell lithium ion*

Depth	33.63 mm (1.32 inches)
Height	42.01 mm (1.65 inches)
Width	279.8 mm (11.02 inches)
Weight	0.41 kg (0.9 lb)
Charge time (approximate)	4 hours (when the computer is turned off)
Voltage	14.8 VDC (4 cell/8 cell)
Operating time (approximate)	Battery operating time varies depending on operating conditions.
Coin-cell battery	CR-2032

## Basic Specifications

### AC Adapter

---

Input voltage	100–240 VAC
Input current	1.5 A
Input frequency	50–60 Hz
Output power	65 W
Output current	3.34 A (continuous)
Rated output voltage	19.5 ± 1 VDC
Operating temperature	0° to 40°C (32° to 104°F)
Storage temperature	–40° to 70°C (–40° to 158°F)

### Physical

---

Height	17.2 mm to 26.4 mm (0.68 inches to 1.04 inches)
Width	329.8 mm (12.98 inches)
Depth	223.0 mm (8.78 inches)
Weight (with ODD Airbay and 4-cell battery)	configurable to less than 1.68 kg (3.7 lbs)

**Computer Environment***Temperature range:*

Operating	0° to 35°C (32° to 95°F)
Non-operating	-40° to 65°C (-40° to 149°F)

*Relative humidity (maximum):*

Operating	10% to 90% (noncondensing)
Non-operating	5% to 95% (noncondensing)

*Maximum vibration (using a random vibration spectrum that simulates user environment):*

Operating	0.66 GRMS
Non-Operating	1.30 GRMS

**Computer Environment**

*Maximum shock (for operating — measured with Dell Diagnostics running on the hard drive and a 2-ms half-sine pulse; for non-operating — measured with hard drive in head-parked position and a 2-ms half-sine pulse):*

Operating	110 G
Non-Operating	160 G
Airborne contaminant level	G2 or lower as defined by ISA-S71.04-1985

# Appendix

## Macrovision Product Notice

This product incorporates copyright protection technology that is protected by method claims of certain U.S. patents and other intellectual property rights owned by Macrovision Corporation and other rights owners. Use of this copyright protection technology must be authorized by Macrovision Corporation, and is intended for home and other limited viewing uses only unless otherwise authorized by Macrovision Corporation. Reverse engineering or disassembly is prohibited.



## Information for NOM, or Official Mexican Standard (only for Mexico)

The following information is provided in the device(s) described in this document in accordance with the requirements of the Official Mexican Standard (NOM):

### Importer:

Dell México S.A. de C.V.

Paseo de la Reforma 2620 – Flat 11°

Col. Lomas Altas

11950 México, D.F.

### Laptops

Regulatory model number	Voltage	Frequency	Electricity consumption	Output voltage	Output intensity
P06S	100-240 V CA	50-60 Hz	1,5 A	19,5 V de CC	3,34 A

For details, read the safety information that shipped with your computer.

For additional safety best practices information, see the Regulatory Compliance Homepage at [www.dell.com/regulatory\\_compliance](http://www.dell.com/regulatory_compliance).

# Index

## A

airflow, allowing **5**

## B

backups  
    creating **31**

## C

calling Dell for assistance **59**  
CDs, playing and creating **30**  
computer capabilities **30**  
computer, setting up **5**  
connect(ing)  
    to the Internet **14**  
conserving energy **31**  
Contacting Dell online **61**

Customer Service **55**  
customizing  
    your desktop **30**  
    your energy settings **31**

## D

damage, avoiding **5**  
Dell Diagnostics **43**  
Dell Factory Image Restore **50**  
Dell Support Center **40**  
Dell support website **63**  
Dell Technology Guide  
    for further information **62**  
Diagnostic Checklist **60**  
drivers and downloads **63**  
DVDs, playing and creating **30**

**E**

- email addresses
  - for technical support **56**
- energy
  - conserving **31**

**F**

- finding more information **62**
- FTP login, anonymous **56**

**H**

- hardware problems
  - diagnosing **43**
- Hardware Troubleshooter **43**
- help
  - getting assistance and support **54**

**I**

- Internet connection **14**
- ISP
  - Internet Service Provider **14**

**N**

- network connection
  - fixing **35**

**P**

- power problems
  - solving **35**
- power strips
  - using **6**
- products
  - information and purchasing **56**

### R

reinstalling Windows **53**

resources

**62**

restoring factory image **50**

Roll Back Driver **52**

### S

setup, before you begin **5**

shipping products

for return or repair **58**

SIM **10**

software features **30**

software problems **38**

solving problems **34**

specifications **64**

support e-mail addresses **56**

support sites

worldwide **56**

system message **41**

system reinstall options **48**

System Restore **48**

### V

ventilation

for computer **5**

ventilation, ensuring **5**

### W

warranty returns **58**

Windows

reinstalling **53**

wired network

network cable, connecting **7**

wireless Internet connection **14**





Printed in the U.S.A.

[www.dell.com](http://www.dell.com) | [support.dell.com](http://support.dell.com)



0MV909A00