

PRECISION TIG 275

For use with machines having Code Numbers: **10806; 10807; 10893**

Safety Depends on You

Lincoln arc welding and cutting equipment is designed and built with safety in mind. However, your overall safety can be increased by proper installation ... and thoughtful operation on your part. **DO NOT INSTALL, OPERATE OR REPAIR THIS EQUIPMENT WITHOUT READING THIS MANUAL AND THE SAFETY PRECAUTIONS CONTAINED THROUGHOUT.** And, most importantly, think before you act and be careful.

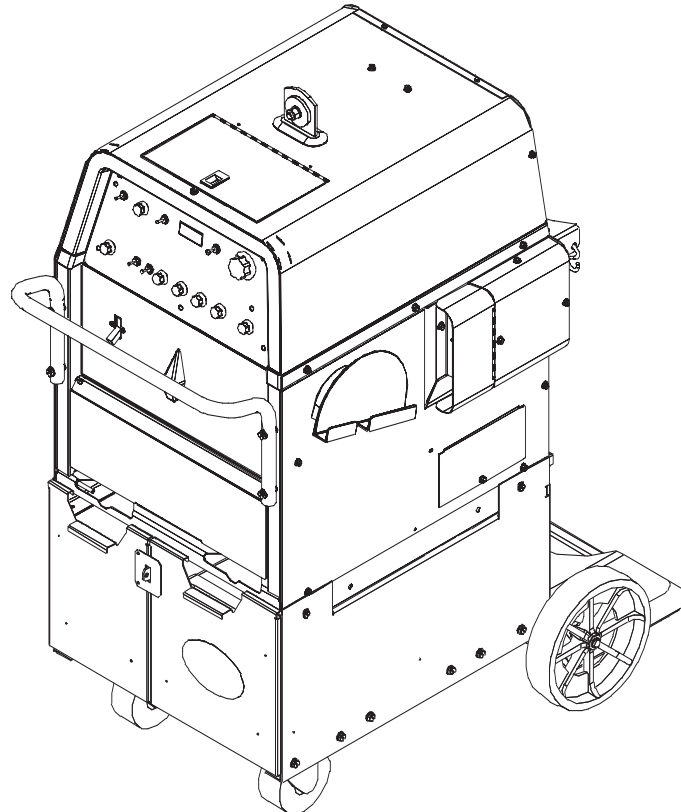

Precision TIG 275 Welding Package shown with optional Advanced Control Panel

IP21S

OPERATOR'S MANUAL



LINCOLN[®]
ELECTRIC

Copyright © 2005 Lincoln Global Inc.

- World's Leader in Welding and Cutting Products •
- Sales and Service through Subsidiaries and Distributors Worldwide •

Cleveland, Ohio 44117-1199 U.S.A. TEL: 216.481.8100 FAX: 216.486.1751 WEB SITE: www.lincolnelectric.com

⚠ WARNING

⚠ CALIFORNIA PROPOSITION 65 WARNINGS ⚠

For Diesel Engines: Diesel engine exhaust and some of its constituents are known to the State of California to cause cancer, birth defects, and other reproductive harm.

For Gasoline Engines: The engine exhaust from this product contains chemicals known to the State of California to cause cancer, birth defects, or other reproductive harm.

ARC WELDING CAN BE HAZARDOUS. PROTECT YOURSELF AND OTHERS FROM POSSIBLE SERIOUS INJURY OR DEATH. KEEP CHILDREN AWAY. PACEMAKER WEARERS SHOULD CONSULT WITH THEIR DOCTOR BEFORE OPERATING.

Read and understand the following safety highlights. For additional safety information, it is strongly recommended that you purchase a copy of "Safety in Welding & Cutting - ANSI Standard Z49.1" from the American Welding Society, P.O. Box 351040, Miami, Florida 33135 or CSA Standard W117.2-1974. A Free copy of "Arc Welding Safety" booklet E205 is available from the Lincoln Electric Company, 22801 St. Clair Avenue, Cleveland, Ohio 44117-1199.

BE SURE THAT ALL INSTALLATION, OPERATION, MAINTENANCE AND REPAIR PROCEDURES ARE PERFORMED ONLY BY QUALIFIED INDIVIDUALS.



FOR ENGINE powered equipment.

1.a. Turn the engine off before troubleshooting and maintenance work unless the maintenance work requires it to be running.



1.b. Operate engines in open, well-ventilated areas or vent the engine exhaust fumes outdoors.



1.c. Do not add the fuel near an open flame welding arc or when the engine is running. Stop the engine and allow it to cool before refueling to prevent spilled fuel from vaporizing on contact with hot engine parts and igniting. Do not spill fuel when filling tank. If fuel is spilled, wipe it up and do not start engine until fumes have been eliminated.

1.d. Keep all equipment safety guards, covers and devices in position and in good repair. Keep hands, hair, clothing and tools away from V-belts, gears, fans and all other moving parts when starting, operating or repairing equipment.

1.e. In some cases it may be necessary to remove safety guards to perform required maintenance. Remove guards only when necessary and replace them when the maintenance requiring their removal is complete. Always use the greatest care when working near moving parts.



1.f. Do not put your hands near the engine fan. Do not attempt to override the governor or idler by pushing on the throttle control rods while the engine is running.

1.g. To prevent accidentally starting gasoline engines while turning the engine or welding generator during maintenance work, disconnect the spark plug wires, distributor cap or magneto wire as appropriate.



1.h. To avoid scalding, do not remove the radiator pressure cap when the engine is hot.



ELECTRIC AND MAGNETIC FIELDS may be dangerous

2.a. Electric current flowing through any conductor causes localized Electric and Magnetic Fields (EMF). Welding current creates EMF fields around welding cables and welding machines

2.b. EMF fields may interfere with some pacemakers, and welders having a pacemaker should consult their physician before welding.

2.c. Exposure to EMF fields in welding may have other health effects which are now not known.

2.d. All welders should use the following procedures in order to minimize exposure to EMF fields from the welding circuit:

2.d.1. Route the electrode and work cables together - Secure them with tape when possible.

2.d.2. Never coil the electrode lead around your body.

2.d.3. Do not place your body between the electrode and work cables. If the electrode cable is on your right side, the work cable should also be on your right side.

2.d.4. Connect the work cable to the workpiece as close as possible to the area being welded.

2.d.5. Do not work next to welding power source.

Mar '95



ELECTRIC SHOCK can kill.

3.a. The electrode and work (or ground) circuits are electrically “hot” when the welder is on. Do not touch these “hot” parts with your bare skin or wet clothing. Wear dry, hole-free gloves to insulate hands.

3.b. Insulate yourself from work and ground using dry insulation. Make certain the insulation is large enough to cover your full area of physical contact with work and ground.

In addition to the normal safety precautions, if welding must be performed under electrically hazardous conditions (in damp locations or while wearing wet clothing; on metal structures such as floors, gratings or scaffolds; when in cramped positions such as sitting, kneeling or lying, if there is a high risk of unavoidable or accidental contact with the workpiece or ground) use the following equipment:

- Semiautomatic DC Constant Voltage (Wire) Welder.
- DC Manual (Stick) Welder.
- AC Welder with Reduced Voltage Control.

3.c. In semiautomatic or automatic wire welding, the electrode, electrode reel, welding head, nozzle or semiautomatic welding gun are also electrically “hot”.

3.d. Always be sure the work cable makes a good electrical connection with the metal being welded. The connection should be as close as possible to the area being welded.

3.e. Ground the work or metal to be welded to a good electrical (earth) ground.

3.f. Maintain the electrode holder, work clamp, welding cable and welding machine in good, safe operating condition. Replace damaged insulation.

3.g. Never dip the electrode in water for cooling.

3.h. Never simultaneously touch electrically “hot” parts of electrode holders connected to two welders because voltage between the two can be the total of the open circuit voltage of both welders.

3.i. When working above floor level, use a safety belt to protect yourself from a fall should you get a shock.

3.j. Also see Items 6.c. and 8.



ARC RAYS can burn.

4.a. Use a shield with the proper filter and cover plates to protect your eyes from sparks and the rays of the arc when welding or observing open arc welding. Headshield and filter lens should conform to ANSI Z87. 1 standards.

4.b. Use suitable clothing made from durable flame-resistant material to protect your skin and that of your helpers from the arc rays.

4.c. Protect other nearby personnel with suitable, non-flammable screening and/or warn them not to watch the arc nor expose themselves to the arc rays or to hot spatter or metal.



FUMES AND GASES can be dangerous.

5.a. Welding may produce fumes and gases hazardous to health. Avoid breathing these fumes and gases. When welding, keep your head out of the fume. Use enough ventilation and/or exhaust at the arc to keep

fumes and gases away from the breathing zone. **When welding with electrodes which require special ventilation such as stainless or hard facing (see instructions on container or MSDS) or on lead or cadmium plated steel and other metals or coatings which produce highly toxic fumes, keep exposure as low as possible and below Threshold Limit Values (TLV) using local exhaust or mechanical ventilation. In confined spaces or in some circumstances, outdoors, a respirator may be required. Additional precautions are also required when welding on galvanized steel.**

5.b. Do not weld in locations near chlorinated hydrocarbon vapors coming from degreasing, cleaning or spraying operations. The heat and rays of the arc can react with solvent vapors to form phosgene, a highly toxic gas, and other irritating products.

5.c. Shielding gases used for arc welding can displace air and cause injury or death. Always use enough ventilation, especially in confined areas, to insure breathing air is safe.

5.d. Read and understand the manufacturer’s instructions for this equipment and the consumables to be used, including the material safety data sheet (MSDS) and follow your employer’s safety practices. MSDS forms are available from your welding distributor or from the manufacturer.

5.e. Also see item 1.b.

Mar '95

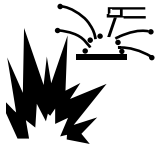

WELDING SPARKS can cause fire or explosion.

6.a. Remove fire hazards from the welding area.

If this is not possible, cover them to prevent the welding sparks from starting a fire.

Remember that welding sparks and hot materials from welding can easily go through small cracks and openings to adjacent areas. Avoid welding near hydraulic lines. Have a fire extinguisher readily available.

6.b. Where compressed gases are to be used at the job site, special precautions should be used to prevent hazardous situations. Refer to "Safety in Welding and Cutting" (ANSI Standard Z49.1) and the operating information for the equipment being used.

6.c. When not welding, make certain no part of the electrode circuit is touching the work or ground. Accidental contact can cause overheating and create a fire hazard.

6.d. Do not heat, cut or weld tanks, drums or containers until the proper steps have been taken to insure that such procedures will not cause flammable or toxic vapors from substances inside. They can cause an explosion even though they have been "cleaned". For information, purchase "Recommended Safe Practices for the Preparation for Welding and Cutting of Containers and Piping That Have Held Hazardous Substances", AWS F4.1 from the American Welding Society (see address above).

6.e. Vent hollow castings or containers before heating, cutting or welding. They may explode.

6.f. Sparks and spatter are thrown from the welding arc. Wear oil free protective garments such as leather gloves, heavy shirt, cuffless trousers, high shoes and a cap over your hair. Wear ear plugs when welding out of position or in confined places. Always wear safety glasses with side shields when in a welding area.

6.g. Connect the work cable to the work as close to the welding area as practical. Work cables connected to the building framework or other locations away from the welding area increase the possibility of the welding current passing through lifting chains, crane cables or other alternate circuits. This can create fire hazards or overheat lifting chains or cables until they fail.

6.h. Also see item 1.c.

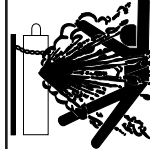

CYLINDER may explode if damaged.

7.a. Use only compressed gas cylinders containing the correct shielding gas for the process used and properly operating regulators designed for the gas and pressure used. All hoses, fittings, etc. should be suitable for the application and maintained in good condition.

7.b. Always keep cylinders in an upright position securely chained to an undercarriage or fixed support.

7.c. Cylinders should be located:

- Away from areas where they may be struck or subjected to physical damage.

- A safe distance from arc welding or cutting operations and any other source of heat, sparks, or flame.

7.d. Never allow the electrode, electrode holder or any other electrically "hot" parts to touch a cylinder.

7.e. Keep your head and face away from the cylinder valve outlet when opening the cylinder valve.

7.f. Valve protection caps should always be in place and hand tight except when the cylinder is in use or connected for use.

7.g. Read and follow the instructions on compressed gas cylinders, associated equipment, and CGA publication P-1, "Precautions for Safe Handling of Compressed Gases in Cylinders," available from the Compressed Gas Association 1235 Jefferson Davis Highway, Arlington, VA 22202.



FOR ELECTRICALLY powered equipment.

8.a. Turn off input power using the disconnect switch at the fuse box before working on the equipment.

8.b. Install equipment in accordance with the U.S. National Electrical Code, all local codes and the manufacturer's recommendations.

8.c. Ground the equipment in accordance with the U.S. National Electrical Code and the manufacturer's recommendations.

Mar '95

PRÉCAUTIONS DE SÛRETÉ

Pour votre propre protection lire et observer toutes les instructions et les précautions de sûreté spécifiques qui paraissent dans ce manuel aussi bien que les précautions de sûreté générales suivantes:

Sûreté Pour Soudage A L'Arc

1. Protégez-vous contre la secousse électrique:
 - a. Les circuits à l'électrode et à la pièce sont sous tension quand la machine à souder est en marche. Éviter toujours tout contact entre les parties sous tension et la peau nue ou les vêtements mouillés. Porter des gants secs et sans trous pour isoler les mains.
 - b. Faire très attention de bien s'isoler de la masse quand on soude dans des endroits humides, ou sur un plancher métallique ou des grilles métalliques, principalement dans les positions assis ou couché pour lesquelles une grande partie du corps peut être en contact avec la masse.
 - c. Maintenir le porte-électrode, la pince de masse, le câble de soudage et la machine à souder en bon et sûr état de fonctionnement.
 - d. Ne jamais plonger le porte-électrode dans l'eau pour le refroidir.
 - e. Ne jamais toucher simultanément les parties sous tension des porte-électrodes connectés à deux machines à souder parce que la tension entre les deux pinces peut être le total de la tension à vide des deux machines.
 - f. Si on utilise la machine à souder comme une source de courant pour soudage semi-automatique, ces précautions pour le porte-électrode s'appliquent aussi au pistolet de soudage.
2. Dans le cas de travail au dessus du niveau du sol, se protéger contre les chutes dans le cas où on reçoit un choc. Ne jamais enrouler le câble-électrode autour de n'importe quelle partie du corps.
3. Un coup d'arc peut être plus sévère qu'un coup de soleil, donc:
 - a. Utiliser un bon masque avec un verre filtrant approprié ainsi qu'un verre blanc afin de se protéger les yeux du rayonnement de l'arc et des projections quand on soude ou quand on regarde l'arc.
 - b. Porter des vêtements convenables afin de protéger la peau de soudeur et des aides contre le rayonnement de l'arc.
 - c. Protéger l'autre personnel travaillant à proximité au soudage à l'aide d'écrans appropriés et non-inflammables.
4. Des gouttes de laitier en fusion sont émises de l'arc de soudage. Se protéger avec des vêtements de protection libres de l'huile, tels que les gants en cuir, chemise épaisse, pantalons sans revers, et chaussures montantes.
5. Toujours porter des lunettes de sécurité dans la zone de soudage. Utiliser des lunettes avec écrans latéraux dans les zones où l'on pique le laitier.

6. Eloigner les matériaux inflammables ou les recouvrir afin de prévenir tout risque d'incendie dû aux étincelles.
7. Quand on ne soude pas, poser la pince à un endroit isolé de la masse. Un court-circuit accidentel peut provoquer un échauffement et un risque d'incendie.
8. S'assurer que la masse est connectée le plus près possible de la zone de travail qu'il est pratique de le faire. Si on place la masse sur la charpente de la construction ou d'autres endroits éloignés de la zone de travail, on augmente le risque de voir passer le courant de soudage par les chaînes de levage, câbles de grue, ou autres circuits. Cela peut provoquer des risques d'incendie ou d'échauffement des chaînes et des câbles jusqu'à ce qu'ils se rompent.
9. Assurer une ventilation suffisante dans la zone de soudage. Ceci est particulièrement important pour le soudage de tôles galvanisées plombées, ou cadmiées ou tout autre métal qui produit des fumées toxiques.
10. Ne pas souder en présence de vapeurs de chlore provenant d'opérations de dégraissage, nettoyage ou pistolage. La chaleur ou les rayons de l'arc peuvent réagir avec les vapeurs du solvant pour produire du phosgène (gas fortement toxique) ou autres produits irritants.
11. Pour obtenir de plus amples renseignements sur la sûreté, voir le code "Code for safety in welding and cutting" CSA Standard W 117.2-1974.

PRÉCAUTIONS DE SÛRETÉ POUR LES MACHINES À SOUDER À TRANSFORMATEUR ET À REDRESSEUR

1. Relier à la terre le châssis du poste conformément au code de l'électricité et aux recommandations du fabricant. Le dispositif de montage ou la pièce à souder doit être branché à une bonne mise à la terre.
2. Autant que possible, l'installation et l'entretien du poste seront effectués par un électricien qualifié.
3. Avant de faire des travaux à l'intérieur de poste, la débrancher à l'interrupteur à la boîte de fusibles.
4. Garder tous les couvercles et dispositifs de sûreté à leur place.

Mar. '93

Thank You

for selecting a **QUALITY** product by Lincoln Electric. We want you to take pride in operating this Lincoln Electric Company product ••• as much pride as we have in bringing this product to you!

Please Examine Carton and Equipment For Damage Immediately

When this equipment is shipped, title passes to the purchaser upon receipt by the carrier. Consequently, Claims for material damaged in shipment must be made by the purchaser against the transportation company at the time the shipment is received.

Please record your equipment identification information below for future reference. This information can be found on your machine nameplate.

Product _____

Model Number _____

Code Number or Date Code _____

Serial Number _____

Date Purchased _____

Where Purchased _____

Whenever you request replacement parts or information on this equipment, always supply the information you have recorded above. The code number is especially important when identifying the correct replacement parts.

On-Line Product Registration

- Register your machine with Lincoln Electric either via fax or over the Internet.

- For faxing: Complete the form on the back of the warranty statement included in the literature packet accompanying this machine and fax the form per the instructions printed on it.
- For On-Line Registration: Go to our **WEB SITE at www.lincolnelectric.com**. Choose "Quick Links" and then "Product Registration". Please complete the form and submit your registration.

Read this Operators Manual completely before attempting to use this equipment. Save this manual and keep it handy for quick reference. Pay particular attention to the safety instructions we have provided for your protection. The level of seriousness to be applied to each is explained below:

WARNING





This statement appears where the information **must** be followed **exactly** to avoid **serious personal injury** or **loss of life**.

CAUTION

This statement appears where the information **must** be followed to avoid **minor personal injury** or **damage to this equipment**.

	Page.
Installation	Section A
Technical Specifications	A-1,A-2
Safety Precautions	A-3
Select Suitable Location	A-3
Grinding	A-3
Stacking	A-3
Undercarriage Lifting and Moving	A-3
Tilting	A-3
Environmental Rating	A-3
Machine Grounding and High FREQUENCY INTERFERENCE PROTECTION	A-3,A-4
Input and Grounding Connections	A-4
Output Cable, Connections and Limitations	A-5
Work Cable Connection	A-5
Stick Electrode Cable Connection	A-5
TIG Torch Connection	A-6
Auxiliary Power Connections	A-7
Remote Control (If Used)	A-7
Robotic Interface Connection	A-7, A-8
OPERATION	Section B-1
Safety Precautions	B-1
Product Description	B-1
Pipe Thawing	B-1
Duty Cycle:	B-1
Recommended Processes and Equipment	B-2
Controls and Settings	B-3 THRU B-6
Internal Set Up Controls	B-7
Sick Welding Features	B-7
TIG Welding Features	B-7
2 Step Trigger Modes	B-8
4 Step Trigger Modes	B-9
TIG Welding Cycle Chart	B-10
Setup Guidelines for TIG Welding with an Amptrol	B-10, B11
Making a TIG Weld with an Amptrol	B-12
Accessories	Section C
Optional Equipment	C-1
Maintenance	Section D
Safety Precautions	D-1
Routine and Periodic Maintenance	D-1
Overload Protection	D-1
Service Procedures, Component Access, Spark Gap Adjustment	D-2
Under-Cooler Service	D-2
Troubleshooting	Section E
Safety Precautions	E-1
How To Use TroubleShooting Guide	E-1
Troubleshooting	E-2 to E-7
Diagrams	Section F
Wiring Diagrams	F-1, F-2
Dimension Prints	F-3, F-4
Parts List	P404

**TECHNICAL SPECIFICATIONS-PRECISION TIG 275 (K1825-1 Domestic Package*-60Hz)
(K1826-1 Domestic,K1826-2 Canadian-60Hz) (K1827-1 Export-50/60Hz)**

RATED INPUT - SINGLE PHASE ONLY				
K Number	Duty Cycle-Applications	Voltage ± 10%	Max. Amps With Out Power Factor Capacitor	Max. Amps With Power Factor Capacitor
K1825-1	40% AC/DC Stick / Balance TIG Unbalance (70% Penetration#) AC TIG	208/230/460	104/94/47 124/112/56	80/72/36 95/86/43
	60% AC/DC Stick / Balance TIG Unbalance (70% Penetration#) AC TIG		86/78/39 95/86/43	64/58/29 62/56/28
	100% AC/DC Stick / Balance TIG Unbalance (70% Penetration#) AC TIG		77/70/35 73/66/33	55/50/25 40/36/18
	Idle Amps		6/5/3	36/32/16
K1826-1  NRTL/C	40% AC/DC Stick / Balance TIG Unbalance (70% Penetration#) AC TIG	460/575	47/38 56/45	35/28 43/34
	60% AC/DC Stick / Balance TIG Unbalance (70% Penetration#) AC TIG		39/31 43/35	29/23 28/23
	100% AC/DC Stick / Balance TIG Unbalance (70% Penetration#) AC TIG		35/28 33/26	25/20 18/14
	Idle Amps		3/2	16/13
	Idle Power		300W	500W
K1826-2  NRTL/C	40% AC/DC Stick / Balance TIG Unbalance (70% Penetration#) AC TIG	220-230/ 380-400/415	95/55/50 109/63/58	80/46/43 86/50/46
	60% AC/DC Stick / Balance TIG Unbalance (70% Penetration#) AC TIG		80/46/42 85/49/45	64/37/34 67/39/36
	100% AC/DC Stick / Balance TIG Unbalance (70% Penetration#) AC TIG		70/41/37 65/38/35	52/30/28 46/27/25
	Idle Amps		10/6/5	23/13/12
	Idle Power		400W	500W
K1827-1   IEC 60974-1	40% AC/DC Stick / Balance TIG Unbalance (70% Penetration#) AC TIG	220-230/ 380-400/415	95/55/50 109/63/58	80/46/43 86/50/46
	60% AC/DC Stick / Balance TIG Unbalance (70% Penetration#) AC TIG		80/46/42 85/49/45	64/37/34 67/39/36
	100% AC/DC Stick / Balance TIG Unbalance (70% Penetration#) AC TIG		70/41/37 65/38/35	52/30/28 46/27/25
	Idle Amps		10/6/5	23/13/12
	Idle Power		400W	500W
RATED POWER FACTOR (STICK)		K1825-1,K1826-1 & K1826-2 K1827-1	.63 min. .65 min.	.85 min. .77 min.
RATED OUTPUT - NEMA EW1 Class II (40) K1825-1,K1826-1,K1826-2				
Duty Cycle-Applications		Volts at Rated Amperes		Amps
40% AC/DC Stick / Balance TIG Unbalance (70% Penetration#) AC TIG		31.0 16.1		275 255
60% AC/DC Stick / Balance TIG Unbalance (70% Penetration#) AC TIG		29.0 15.4		225 200
100% AC/DC Stick / Balance TIG Unbalance (70% Penetration#) AC TIG		28.0 14.8		200 150

*Shown on Front of this IM manual with Under-Cooler Cart and Advanced Control Panel (Refer to Optional Equipment)

#Exceeds NEMA Unbalanced Load Specification comparable for Auto-Balance.

RATED OUTPUT - IEC 60974-1 (K1827-1)

Duty Cycle-Applications	Volts at Rated Amperes	Amps
40% AC/DC Stick / Balance TIG Unbalance (70% Penetration#) AC TIG	31.0 20.2	275 255
60% AC/DC Stick / Balance TIG Unbalance (70% Penetration#) AC TIG	29.0 18.0	225 200
100% AC/DC Stick / Balance TIG Unbalance (70% Penetration#) AC TIG	28.0 16.0	200 150

ADDITIONAL OUTPUT CAPACITY

Output Current Range	Maximum Open Circuit Voltage	Type of Output	Auxiliary Power
2Amps DC to 340Amps AC-DC*	(STICK AND TIG) AC/DC OCV: 75/68	CC (Constant Current) AC/DC (GTAW) Stick (SMAW)	K1825-1, K1826-1, K1826-2 15Amp Circuit Breaker and NEMA 5-15R Duplex Receptacle for up to: 115VAC 8Amp Auxiliary Power Receptacle 115VAC weld Switched Cooler Receptacle load K1834-1 5 Amp Circuit Breaker and grounded 220VAC Euro(Schuko) receptacle

RECOMMENDED INPUT WIRE AND FUSE SIZES

For all Stick, DC TIG, and Balanced AC TIG Welding at 275A/40% Duty Cycle with out Standard Power Factor Correction Capacitors Based on the 1999 U.S. National Electrical Code					For Unbalanced AC TIG Welding Above 275 Amps: 255A/40% Duty Cycle, Auto-Balance Penetration with out Standard Power Factor Correction Capacitors Based on the 1999 U.S. National Electrical Code			
Input Voltage / phase/ Frequency	Fuse (Super Lag) or Breaker Size ¹	Input Ampere Rating Rating on Nameplate	Type 75°C Copper Wire in Conduit AWG (IEC) Sizes 40°C (104°F) Ambient	Type 75°C Copper Ground Wire in Conduit AWG (IEC) Sizes	Fuse (Super Lag) or Breaker Size ¹	Input Ampere Rating	Type 75°C Copper Wire in Conduit AWG (IEC) Sizes 40°C (104°F) Ambient	Type 75°C Copper Ground Wire in Conduit AWG (IEC) Sizes
208/1/60	125	104	4 (21.2 mm ²)	6 (13.3 mm ²)	150	124	3 (26.7 mm ²)	6 (13.3 mm ²)
230/1/60	125	94	4 (21.2 mm ²)	6 (13.3 mm ²)	150	112	3 (26.7 mm ²)	6 (13.3 mm ²)
460/1/60	60	47	8 (8.4mm ²)	10 (5.3mm ²)	70	56	8 (8.4 mm ²)	8 (8.4 mm ²)
575/1/60	50	38	10 (5.3mm ²)	10 (5.3mm ²)	60	45	8 (8.4 mm ²)	10 (5.3mm ²)
220-230/1/50/60	125	95	4 (21.2 mm ²)	6 (13.3 mm ²)	150	109	4 (21.2 mm ²)	6 (13.3 mm ²)
380-400/1/50/60	80	55	8 (8.4mm ²)	8 (8.4mm ²)	90	63	6 (13.3 mm ²)	8 (8.4 mm ²)
415/1/50/60	80	50	8 (8.4mm ²)	8 (8.4mm ²)	90	58	6 (13.3 mm ²)	8 (8.4 mm ²)

PHYSICAL DIMENSIONS

	Height	Width	Depth	Weight
K1826-1, -2 K1827-1	31.0 in. 787 mm	22.0 in. 559 mm	26.0 in. 660 mm	Approx. 397 lbs. 180 kgs.
K1825-1	49.7 in. 1262 mm	28.0 in. 711 mm	41.0 in. 1041 mm	Approx. 641 lbs. 291 kgs.

TEMPERATURE RANGES

OPERATING TEMPERATURE RANGE -20°C to +40°C (-04° to +104°F)	STORAGE TEMPERATURE RANGE -40°C to +85°C (-40° to +185°F)
TRANSFORMER INSULATION CLASS 180°C (H)	

¹ ALSO CALLED 'INVERSE TIME' OR "THERMAL/MAGNETIC " CIRCUIT BREAKERS; CIRCUIT BREAKERS WHICH HAVE A DELAY IN TRIPPING ACTION THAT DECREASES AS THE MAGNITUDE OF CURRENT INCREASES.

* 50/60Hz IEC Max. range exceeds 310A.

PRECISION TIG 275



SAFETY PRECAUTIONS

Read entire installation section before starting installation.

WARNING



ELECTRIC SHOCK can kill.

- Only qualified personnel should perform this installation.
- Turn the input power OFF at the disconnect switch or fuse box before working on this equipment.

- Do not touch electrically hot parts.
- Always connect the Precision TIG 275 grounding screw (behind the reconnect panel cover located near the back of the left case side) to a good electrical earth ground.
- Always connect the Precision TIG 275 to a power supply grounded in accordance with the National Electrical Code and all local codes.

SELECT SUITABLE LOCATION

Place the welder where clean cooling air can freely circulate in through the top rear vents and out through the bottom rear vents. Dirt, dust or any foreign material that can be drawn into the welder should be kept at a minimum. Failure to observe these precautions can result in excessive operating temperatures and nuisance trips.

GRINDING

Do not direct grinding particles towards the welder. An abundance of conductive material can cause maintenance problems.

STACKING

The Precision TIG 275's cannot be stacked .

UNDERCARRIAGE LIFTING AND MOVING

When the Precision TIG 275 is purchased as a welding package, or used with any of the available Undercarriage optional accessories, proper installation makes the Precision TIG 275 lift bale nonfunctional. Do not attempt to lift the power source with an undercarriage attached. The undercarriage is designed for hand moving only; mechanized movement can lead to personal injury and/or damage to the Precision TIG 275.

TILTING

Each machine must be placed on a secure, level surface, either directly or on a recommended undercarriage. The machine may topple over if this precaution is not followed.

ENVIRONMENTAL RATING

Precision TIG 275 power sources carry an IP21S Environmental rating. They are rated for use in damp, dirty rain-sheltered environments.

MACHINE GROUNDING AND HIGH FREQUENCY INTERFERENCE PROTECTION

The frame of the welder must be grounded. A ground screw marked with the symbol \oplus is located on the input connection panel (Figure A.1) for this purpose. See your local and national electrical codes for proper grounding methods.

The spark gap oscillator in the high frequency generator, being similar to a radio transmitter, can be blamed for many radio, TV and electronic equipment interference problems. These problems may be the result of radiated interference. Proper grounding methods can reduce or eliminate radiated interference.

The Precision TIG 275 has been field tested under recommended installation conditions and has been found to comply with F.C.C. allowable radiation limits. This welder has also been found to comply with NEMA standards for high frequency stabilized power sources.

Radiated interference can develop in the following four ways:

- Direct interference radiated from the welder.
- Direct interference radiated from the welding leads.
- Direct interference radiated from feedback into the power lines.
- Interference from re-radiation of "pickup" by ungrounded metallic objects.

Keeping these contributing factors in mind, installing the equipment per the following instructions should minimize problems.

1. Keep the welder power supply lines as short as possible and completely enclose them in rigid metallic conduit or equivalent shielding for a minimum distance of 50 feet (15.2 m). There must be good electrical contact between this conduit and the welder. Both ends of the conduit must be connected to a driven ground and the entire length must be continuous.
2. Keep the work and electrode leads as short as possible and as close together as possible. Lengths should not exceed 25 feet (7.6 m). Tape the leads together when practical.

3. Be sure the torch and work cable rubber coverings are free of cuts and cracks that allow high frequency leakage. Cables with high natural rubber content, such as Lincoln Stable-Arc® better resist high frequency leakage than neoprene and other synthetic rubber insulated cables.
4. Keep the torch in good repair and all connections tight to reduce high frequency leakage.
5. The work terminal must be connected to a ground within ten feet of the welder, using one of the following methods:
 - A metal underground water pipe in direct contact with the earth for ten feet or more.
 - A 3/4" (19 mm) galvanized pipe or a 5/8" (16 mm) solid galvanized iron, steel or copper rod driven at least eight feet into the ground.

The ground should be securely made and the grounding cable should be as short as possible using cable of the same size as the work cable, or larger. Grounding to the building frame electrical conduit or a long pipe system can result in re-radiation, effectively making these members radiating antennas. (This is not recommended).

6. Keep all access panels and covers securely in place.
7. All electrical conductors within 50 feet (15.2 m) of the welder should be enclosed in grounded rigid metallic conduit or equivalent shielding. Flexible helically-wrapped metallic conduit is generally not suitable.
8. When the welder is enclosed in a metal building, several good earth driven electrical grounds (as in 5 above) around the periphery of the building are recommended.

Failure to observe these recommended installation procedures can cause radio or TV interference problems and result in unsatisfactory welding performance resulting from lost high frequency power.

INPUT and GROUNDING CONNECTIONS

⚠ WARNING



ELECTRIC SHOCK can kill.

- Turn the input power OFF at the disconnect switch or fuse box before working on this equipment.

Be sure the voltage, phase, and frequency of the input power is as specified on the rating plate, located on the rear of the machine.

Fuse the input circuit with the recommended super lag fuses or delay type1 circuit breakers. Choose an input and grounding wire size according to local or national codes or use Section A-2. Using fuses or circuit breakers smaller than recommended may result in "nuisance" tripping from welder inrush currents even if not welding at high currents.

Unbalanced AC TIG welding draws higher input currents than those for Stick, DC TIG, or Balanced AC TIG welding. The welder is designed for these higher input currents. However, where unbalanced AC TIG welding above 185 amps is planned, the higher input currents require larger input wire sizes and fuses per Section A-2:

Remove the reconnect panel cover located near the back of the left case side to reveal the reconnect panel. Welder supply line entry provision is in the case rear panel. Entry is through a 1.75 inch (44 mm) diameter hole in the case back. Appropriate supply line strain relief clamp is provided by installer. (See Figure A.1)

FIGURE A.1

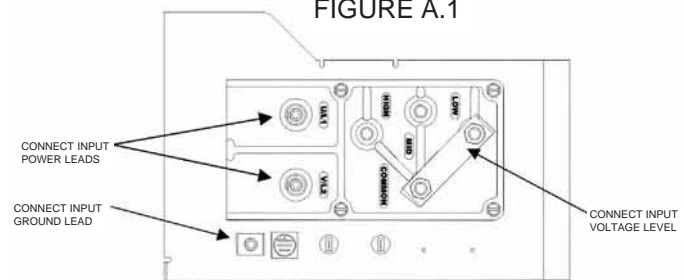

All connections should be made in accordance with all local codes and national electrical codes. Installation by a qualified electrician is recommended.

1. Connect the terminal marked \oplus (below the reconnect panel) to an earth ground.
2. Connect the input leads to terminals marked L1 (U) and L2 (V) on the reconnect panel. Use a single phase line or one phase of a two or three phase line.
3. On multiple input voltage welders, be sure the reconnect panel is connected for the voltage being supplied to the welder.

CAUTION

Failure to follow these instructions can cause immediate failure of components within the welder.

Welders are shipped connected for the highest input voltage as listed on the rating plate. To change this connection, designations on the reconnect panel LOW, MID, and HIGH correspond to the name plated input voltages of a triple voltage welder. Dual voltage welders use only LOW and HIGH.

EXAMPLE: On a 208/230/460 volt welder, LOW is 208V, MID is 230V, and HIGH is 460V.

Note: Export model has a voltage range for **LOW** and **MID** connections: **LOW** is 220-230V, **MID** is 380-400V and **High** is 415V.

Reconnect the jumper strap to the terminal stud corresponding to the input voltage level used. Make sure all connections are tight.

OUTPUT CABLES, CONNECTIONS AND LIMITATIONS

WARNING

- To avoid being startled by a high frequency shock, keep the TIG torch and cables in good condition
- Turn the power switch of the power source OFF before installing adapters on cable or when connecting or disconnecting adapter plugs to power source.

Refer to Figure A.2 for the location of the WORK and STICK terminals, as well as the TIG Torch connection panel.

Recommended Cable Sizes for Combined Lengths of Copper Work and Electrode Cables using 75° C Wire:

Machine Rating	0 to 100 Ft.	101 to 200 Ft	201 to 250 Ft
275A/40%	#1 (42.4 mm ²)	1/0 (53.5 mm ²)	2/0 (67.4 mm ²)

WORK CABLE CONNECTION

A 15' (2/0) weld cable with clamp is available (K2150-1), or included with the Precision TIG Welding Package model. Otherwise, it is user provided.

With power source off, connect a separate work cable to the 1/2-13 threaded "WORK" stud of the welder, and secure a tight connection with the flange nut provided. The work cable should be routed through the cable strain relief hole provided in the base directly below the welding output terminal.

Note: If the Precision TIG is equipped with an Under-Cooler or Under-Storage unit, the coiled work cable and clamp, or excess work cable length, may be conveniently stored in the drawer while remaining connected.

STICK ELECTRODE CABLE CONNECTION

If manual stick welding is desired, with power source off, connect a stick electrode cable to the 1/2-13 threaded "STICK Electrode" stud of the welder, and secure a tight connection with the flange nut provided. The electrode cable should be routed through the cable strain relief hole provided in the base directly below the welding output terminal.

WARNING

DISCONNECT STICK ELECTRODE WELDING CABLE WHEN TIG WELDING.

EVEN THOUGH HI-FREQ IS NOT APPLIED TO THE PRECISION TIG STICK TERMINAL, IT WILL BE ELECTRICALLY "HOT" TO WORK WHEN TIG WELDING.

FIGURE A.2

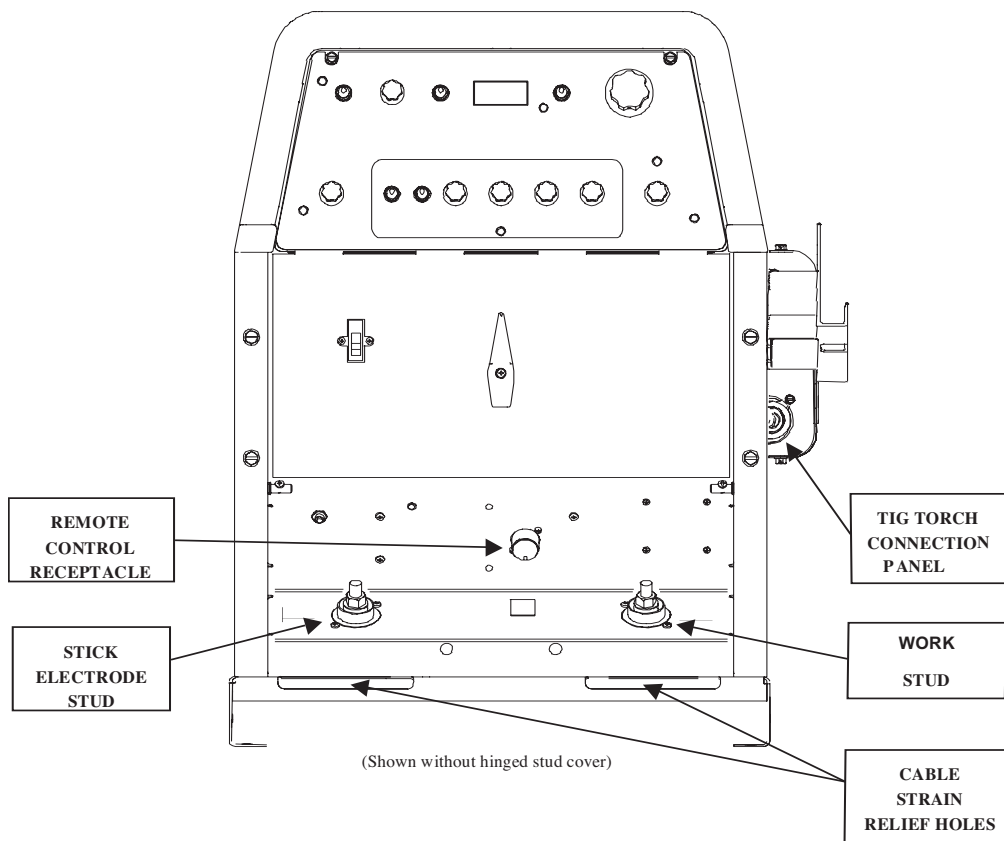

TIG TORCH CONNECTION

The Precision TIG torch connection box, located on the right side of the machine, provides all the input and output connections for the installation of both air-cooled and water-cooled TIG torches with fittings conforming to Compressed Gas Association (CGA) standards:

Note: The Precision TIG provides an insulated Torch Reel and Holster for handy and safe storage of connected torch when not welding, and excess torch cable length while welding.

⚠ WARNING

Combination connectors (Power/Water and Power/Gas) are electrically "hot" while welding in STICK or TIG modes.

If using an Air-Cooled Torch be sure coolant is shut off and/or Cooler is unplugged from the Precision TIG Water Cooler Receptacle on the torch side of the upper case back.

Observe the safety precautions necessary for handling and using compressed gas containers. Contact your supplier for specifics.

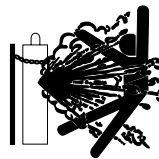

CYLINDER could explode if damaged.

- Keep cylinder upright and chained to a support.
- Keep cylinder away from areas where it could be damaged.
- Never allow the torch to touch the cylinder.
- Keep cylinder away from live electrical circuits.
- Maximum inlet pressure 150 psi.

The Precision TIG machines do not have Hi-Freq. available at the Stick electrode stud, therefore stud connection adapters (such as LECO. S19257-series) cannot be used for torch connection.

Single-piece cable air-cooled torches with a 3/8-24 RH connector fitting (such as the Magnum PTA-9/-17, or LA-9/-17) require the provided S20403-4 Torch Connector, while those with a 7/8-14 RH connector fitting (such as the Magnum PTA-26, or LA-26) require the available K2166-1 Torch Connector. (See Figure A.3)

Two-piece cable air-cooled torches (such as PTA-, or LA-torches) can be used with the available 1/2" Stud Connector (S20403-3) with with a 7/8-14 LH male fitting.

Magnum PTW-18/-20 (or LW-) water-cooled Torches require no adapter for Precision TIG connection.

PRECISION TIG 275



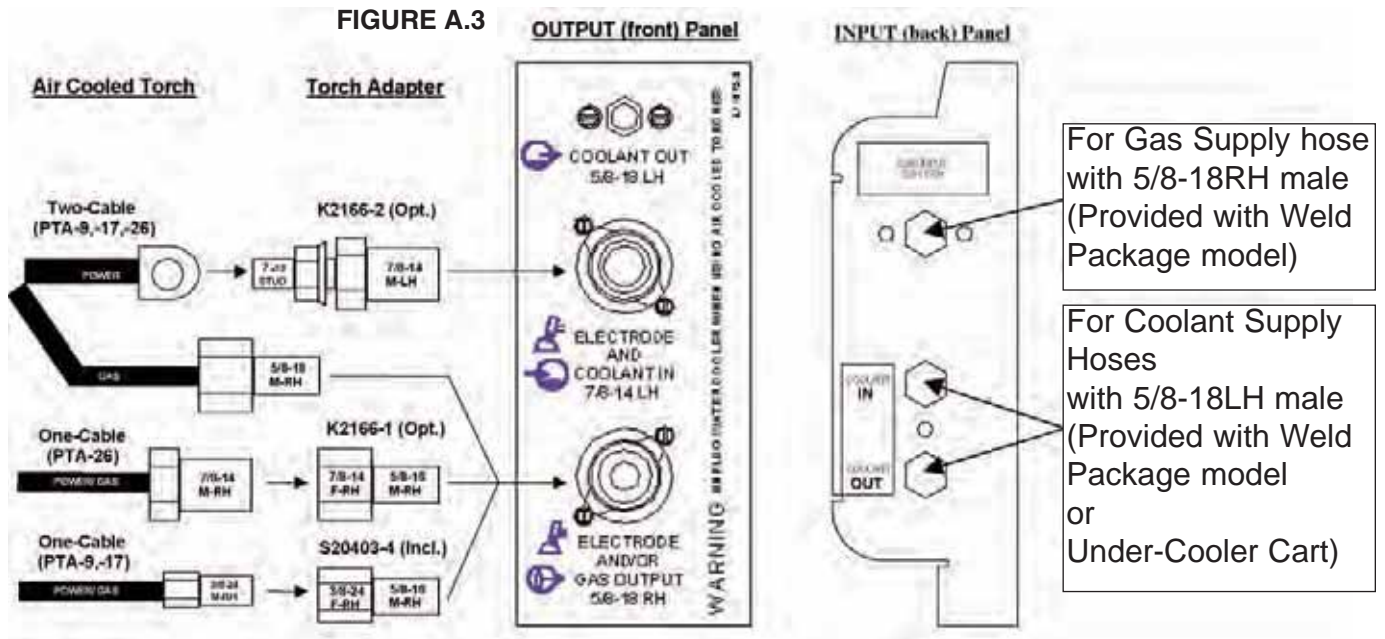

AUXILIARY POWER CONNECTIONS

The Precision TIG machines provide a standard NEMA 5-15R duplex receptacle, located on the upper case back on the torch side of the machine:

- The bottom outlet of this duplex receptacle provides switched 115VAC power for the Under-Cooler, or Water Solenoid accessory. This Cooler receptacle turns on when the arc starts and remains on for about 8 minutes after the arc goes out (with the Fan-As-Needed machine cooling fan, see Maintenance Section), so the Cooler's fan and water pump will not run continuously in idle, but will run while welding.
- The top outlet of this duplex receptacle provides at least 8 amps at 115VAC, whenever the Precision TIG Power switch is ON. This auxiliary circuit is intended for running 115VAC accessories or small power tools. **Note:** Some types of equipment, especially pumps and large motors, have starting currents which are significantly higher than their running current. These higher starting currents may cause the circuit breaker to open. (See next paragraph)
- Both the receptacle circuits are protected from shorts and overloads by a 15 amp circuit breaker, located above the receptacle. If the breaker trips its button pops out exposing a red ring. When the circuit breaker cools the button can be reset by pressing it back in. **Note:** When the breaker trips not only will the auxiliary and cooler power be interrupted, but so will the power to the shielding gas solenoid and machine cooling fan.

The Precision TIG **Export models** also provide a grounded 220vac Euro type Schuko receptacle and a 5 amp circuit breaker, located on the upper case back on the reconnect side of the machine, intended for use with a 220vac water cooler.

REMOTE CONTROL (If Used)

The Foot Amptrol (included with the Precision TIG Welding Package), or other Remote accessory, is installed by routing the plug of its control cable up through the left cable strain relief hole provided in the base (see Figure A.2), then connecting the 6-pin plug to the mating Remote receptacle behind the stud panel cover. (See Operation Section B-2 for mating plug wiring.)

Note: If the Precision TIG is equipped with an Under-Cooler or Under-Storage unit, the Foot Pedal (or other remote control accessory) and coiled control cable, or excess cable length, may be conveniently stored in the drawer while remaining connected.

ROBOTIC INTERFACE CONNECTION

Robotic interface can be made at the Remote Receptacle (See Operation Section B-2). The machine is shipped with the remote receptacle circuit internally connected to receptacle J5 of the Control board for standard Amptrol operation. In order to enable the remote receptacle for robotic interface its connection plug must be moved from J5 to J5A on the Control board. (Refer to the machine Wiring Diagram.)

The robotic interface functions with the Precision TIG set to either TIG or STICK mode, but must be in REMOTE switch position for the Preset Control interface to function. When in the REMOTE position with robotic interface neither the MAXIMUM OUTPUT nor the MINIMUM OUTPUT panel controls limit the interface control setting over the rated output range of the machine.

The diagram in Figure A.4 below shows the remote receptacle plug connections and signals for robotic interface:

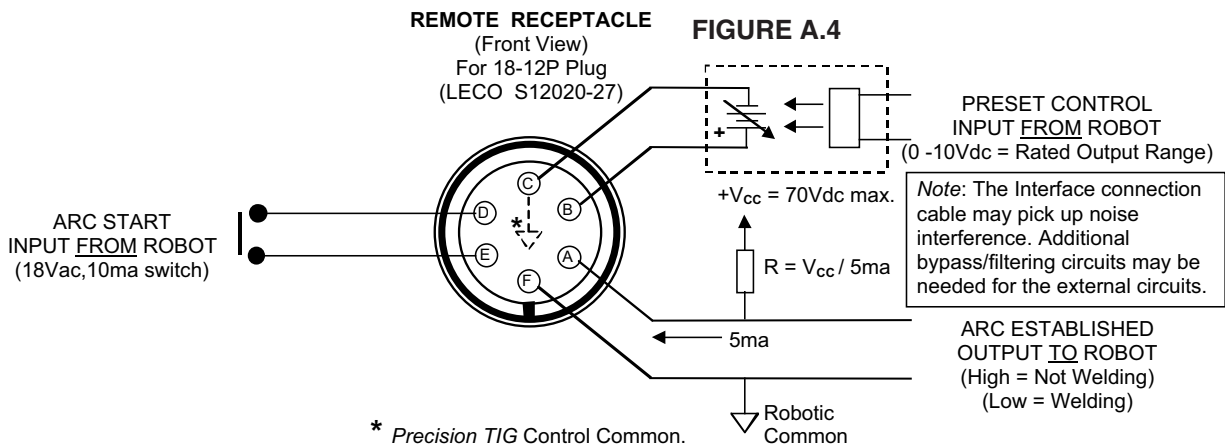

SAFETY PRECAUTIONS

Read and understand this entire section before operating the machine.

WARNING



ELECTRIC SHOCK can kill.

- Only qualified personnel should perform this installation.
- Turn the input power OFF at the disconnect switch or fuse box.
- Do not touch electrically live parts or electrode with skin or wet clothing.
- Insulate yourself from work and ground.
- Always wear dry insulating gloves.
- Read and follow “Electric Shock Warnings” in the Safety section if welding must be performed under electrically hazardous conditions such as welding in wet areas or on or in the workpiece.



FUMES AND GASES can be dangerous.

- Keep your head out of fumes.
- Use ventilation or exhaust to remove fumes from breathing zone.

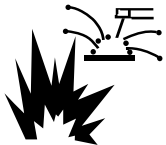

WELDING SPARKS can cause fire or explosion

- Keep flammable material away.
- Do not weld on containers that have held combustibles.



ARC RAYS can burn.

- Wear eye, ear and body protection.

Observe additional Safety Guidelines detailed in the beginning of this manual.

PRODUCT DESCRIPTION

The Precision TIG 275 is part of a new family of industrial arc welding power sources providing constant current, single range square wave AC/DC TIG (GTAW) with new patented (pending) Micro-Start™ Technology, Presettable Min. and Max. Output controls, and built-in high frequency stabilization for continuous AC TIG and DC TIG starting. It also has AC/DC Stick (SMAW) capability, with adjustable Arc Force availability. A TIG Pulse Panel, Power Factor Capacitors and a Water Solenoid are available as field installed optional kits. Also, a new Undercarriage (with double gas bottle rack) is available for field installation, as well as a new Under-Cooler Cart, which is also included in an available efficiently integrated entire TIG Welding Package with convenient built-in storage provisions for welding equipment and components.

The Precision TIG 275 includes advanced features such as a Digital Meter, Presettable control, Auto Balance™, Fan As Needed (F.A.N.) fixed Preflow, variable Postflow shielding gas and Timers. In addition, 2-Step/4-Step and Pulse TIG operation with adjustable Downslope Time control are included with an available field installed kit. It also features a Stick stud panel and a universal TIG torch connection box for simultaneous, but separated, electrode outputs.

PIPE THAWING

The Precision TIG 275 is not recommended for pipe thawing.

Duty Cycle

The duty cycle is based upon a 10-minute time period; i.e., for 40% duty cycle, it is 4 minutes welding and 6 minutes idling. If the rated duty cycle is significantly exceeded, the thermostatic protection will shut off the output until the machine cools to a normal operating temperature. (Refer to Specification Section A-1)

RECOMMENDED PROCESSES AND EQUIPMENT

RECOMMENDED PROCESSES

The Precision TIG 275 is recommended for the TIG (GTAW) and Stick (SMAW) welding processes within its output capacity range of 2 amps DC, or 5 amps AC, to 340 amps AC/DC. It is compatible with most Magnum TIG accessories (refer Equipment Limitations), as well as many industry standard items, such as TIG torches, hoses, and water coolers.

PROCESS LIMITATIONS

Precision TIG machines are not recommended for arc gouging due to its limited output capacity, and are also not recommended for pipe thawing.

EQUIPMENT LIMITATIONS

The Precision TIG machines are protected from overloads beyond the electrical ratings and duty cycles, per the Specifications Section A-1, A-2, with Thermostat protection of the primary and secondary transformer coils.

The Precision TIG machines do not have Hi-Freq. available at the Stick electrode stud, therefore stud connection adapters (such as LECO. S19257-series) cannot be used for torch connection.

RECOMMENDED EQUIPMENT/INTERFACE

Machine:	<u>TIG (water cooled)</u> PT275 Welding Package (K1825-1)	<u>TIG (air cooled)</u> PT275(K1826-1, -2, K1827-1)
Input Cable/Clamp:	User provided	User provided
Gas Reg./Hose:	(included)	LE/Harris 3100211
Magnum Torch:	(PTW20 included)	PTA9 or PTA17
Magnum Parts:	(KP510 and K918-2 included)	KP507 or KP508
Work Clamp/Lead:	(15 ft. included)	K2150-1 Work Lead Assembly
Foot Amptrol:	(K870 included)	K870 or K870-1

CONTROLS AND SETTINGS

The Front Control Panel contains the knobs and switches necessary for adjusting the operation of the Precision TIG 275, with function indicator lights and an electronic display for volts and amps. The components are described below:

FIGURE B.1 - CONTROL PANEL

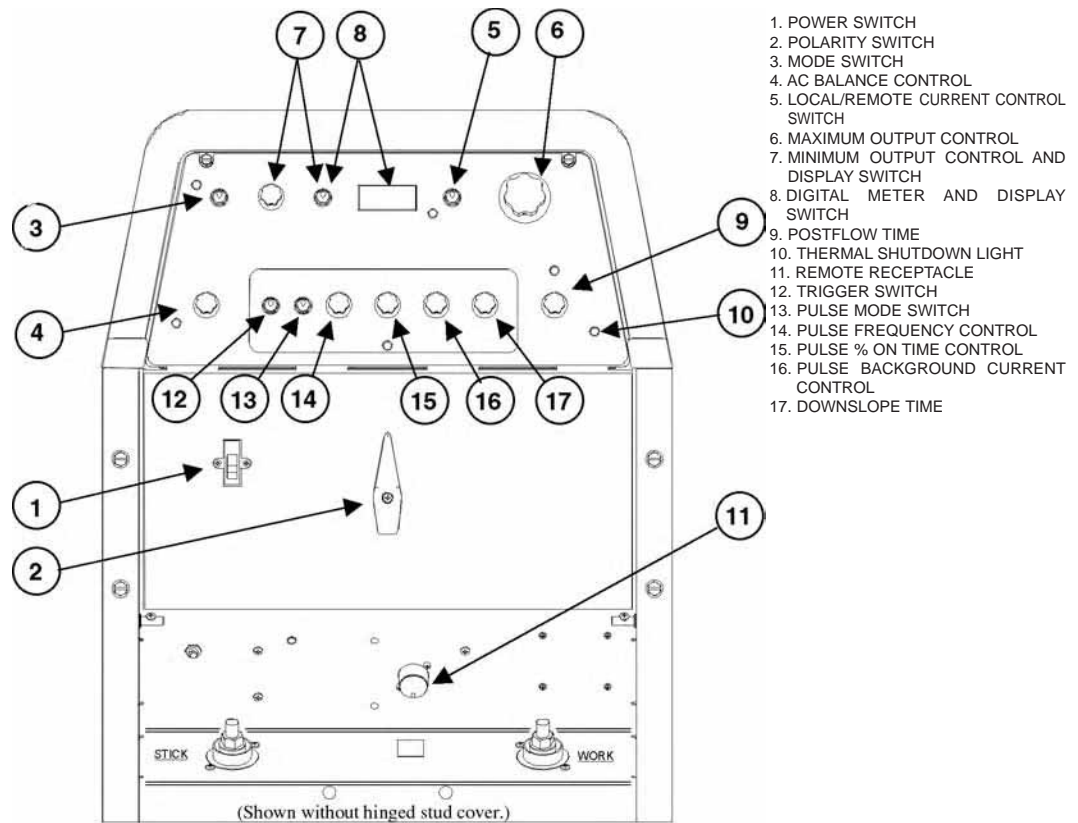

1. POWER SWITCH
2. POLARITY SWITCH
3. MODE SWITCH
4. AC BALANCE CONTROL
5. LOCAL/REMOTE CURRENT CONTROL SWITCH
6. MAXIMUM OUTPUT CONTROL
7. MINIMUM OUTPUT CONTROL AND DISPLAY SWITCH
8. DIGITAL METER AND DISPLAY SWITCH
9. POSTFLOW TIME
10. THERMAL SHUTDOWN LIGHT
11. REMOTE RECEPTACLE
12. TRIGGER SWITCH
13. PULSE MODE SWITCH
14. PULSE FREQUENCY CONTROL
15. PULSE % ON TIME CONTROL
16. PULSE BACKGROUND CURRENT CONTROL
17. DOWNSLOPE TIME

1. POWER SWITCH - Input line switch turns input power ON or OFF, as indicated by the on or off status of the front panel displays.

2. POLARITY SWITCH - The 3-position rotary power switch has detente positions for DC-, AC and DC+ selections for the Electrode output welding polarity.

3. MODE SWITCH - The mode switch allows vertically positioned selection of the two machine welding modes. The selected mode is indicated by a lit colored panel light which permits viewing the machine setting from a distance:

3.a STICK mode (Top position) -Red panel light

⚠ WARNING



ELECTRIC SHOCK can kill.
 • When the Power Source is ON in STICK mode the Electrode circuits of both the Stick and TIG torch cables are electrically HOT to Work.

• The CC Stick mode may be used for general purpose stick welding (SMAW) within the capacity of the machine. The capacity is too limited for arc air carbon (AAC) gouging.

• In this mode; the output terminals are activated electrically HOT, gas flow is not activated and HOT START and ARC FORCE levels are fixed, or Advanced Panel selectable (See Section B-7), with no front panel adjustment.

3.b TIG mode (Bottom position) - No panel light.

• When the Polarity Switch is set to AC, the TIG mode provides continuous high frequency to stabilize the arc for AC TIG welding.

Hi-Freq. turns on after preflow time with the arc start switch closure, and turns off when the arc goes out* after the arc start switch opens.

* Arc voltage and current are sensed to determine if the arc is established or out.

PRECISION TIG 275

- When the Polarity Switch is set to DC (- or +), the TIG mode provides high frequency only for starting.

Hi-Freq. turns on after pre-flow time with the arc start switch closure, and turns off when the arc is established*

- Also functions for DC+ polarity to permit "balling" of tungsten for AC TIG welding.

4. AC BALANCE CONTROL – The potentiometer control permits AC wave balance adjustment from Max. Penetration (~85% negative wave) with the control at Max. full CW position, to Max. Cleaning (~65% positive wave) with the control set near minimum CCW position.

- Full minimum CCW position is the Auto Balance position which is indicated by the Green panel light turning on. This feature automatically provides the proper amount of cleaning and penetration for normal AC TIG welding
- The mid position is the Balanced position (~50% positive and negative waves).
- The Balance control is only functional if the machine is set to AC polarity and TIG mode.

5. LOCAL/REMOTE CURRENT CONTROL SWITCH – A 2-position switch selects how the welding output is controlled for both Stick and TIG Modes:

- LOCAL (Top position) selects output control only by the machine panel Output Control. (See Item 6)
- REMOTE (Bottom position) selects output control to also be by an Amptrol (See Item 6), or other remote (10K pot) control connected to the Remote receptacle (See Item 11) This switch selection is indicated by the Green panel light turning on.

In either position the arc start switch functions when connected to the Remote receptacle (See Item 11).

6. MAXIMUM OUTPUT CONTROL – The large knob is used to set the output welding current over the rated output range of the machine.

- With the Current Control switch to LOCAL position, this knob sets the welding output level.

- With the Current Control switch to REMOTE position, this knob sets the maximum welding level that the Peak output can be set with the remote Amptrol.

- The new MicroStart™ Technology minimum current circuit provides for low end welding (down to 2 amps) previously unobtainable on an SCR platform TIG machine.

7. MINIMUM OUTPUT CONTROL AND DISPLAY SWITCH

A smaller knob is used to preset the minimum current level only for TIG mode. Pressing the Display (momentary) switch toggle left to Minimum Set position displays the Minimum control level setting on the Digital meter. (See Item 8)

- This knob sets the Start output level. When the arc lights (using a new built-in TIG start pulse) this level upslopes quickly (0.5 sec.w/ Advanced Panel, zero w/o) and smoothly to the weld output level. The setting range for this Start control is the 2 amp minimum range of the machine up to about 50 amps, but no more than the level set by the Maximum Output control knob (See Item 6), but otherwise is independent of the Maximum setting.
- This setting also serves as the Crater-fill level, but with a Precision TIG Advanced Panel it can be selected (see Section B-7) to be either the Minimum Output control setting (same as Start setting) as shipped, or the minimum rating of the machine (2 amps).
- The Remote Amptrol range of control is between this Minimum setting and the Maximum Output control knob setting, so these knobs can set the resolution of the Amptrol. Also, the Minimum setting serves as both the minimum Amptrol start level when the arc start switch is closed, as well as the minimum Amptrol crater-fill level before the arc start switch is opened to help prevent premature arc out and Hi-Freq re-initiation.

- In STICK mode the Start control is not functional since Hot Start level is fixed, or internal Advanced Panel adjustable (see Section B-7). Pressing the Display (momentary) switch toggle left to Minimum Output position displays minimum amps rating of the machine.

8. DIGITAL METER AND DISPLAY SWITCH— A 3-digit LED meter is used to monitor the preset and actual welding procedure based on the Display (momentary) switch position:

- Before welding with Display switch in center (normal) position, the digital meter displays the preset welding amps set by Maximum Output control knob (See Item 6). If in Stick mode using REMOTE (See Item 5.), the digital meter displays the preset welding amps set by the Remote control. (See Item 11)
- While welding with Display switch in center (normal) position, the digital meter displays the actual welding amps with one amp resolution (XXX) and accuracy within 4%+/-2A of reading.
- Any time in TIG mode and while pressing the Display switch to left, the digital meter displays the amps preset by the Minimum Output control knob (See Item 7).
- Any time in Stick mode and while pressing the Display switch to left, the digital meter displays the minimum amps rating of the machine (See Item 7).
- Any time, in either mode, while pressing the Display switch right to Volts position, the digital meter displays actual output volts. Volts is displayed with 0.1 volt resolution (XX.X) and accuracy within 3%+/-1V of reading.

9. POSTFLOW TIME – This knob is used to set the TIG mode shielding gas postflow time over the range of about 2 to 60 seconds after the arc is shut off. The postflow on time status is indicated by the Green panel light.

- Gas preflow time for TIG mode is fixed at 0.5 second, with no panel control.
- Both time ranges are x2 extendable, if needed, by internal control box selection. (See Section B-7)

10. THERMAL SHUTDOWN LIGHT – This yellow LED panel light turns on if the machine output is shut-down because internal overheating has occurred, and turns off when the thermostat resets.

11. REMOTE RECEPTACLE – A 6-socket receptacle is provided for the connection of an Amptrol, or other, remote control: (See Figure B.2)

- When the Current Control Switch, (See Item 5), is in the REMOTE position the Amptrol, or other remote (10K pot), connected to the Remote receptacle controls the TIG or Stick mode output within the range preset by the Maximum and Minimum Output controls. (See Item 6 and Item 7, also 8 for meter display)

- When the Current Control Switch is in either LOCAL or REMOTE positions the arc start switch functions when connected to the Remote receptacle.

FIGURE B.2

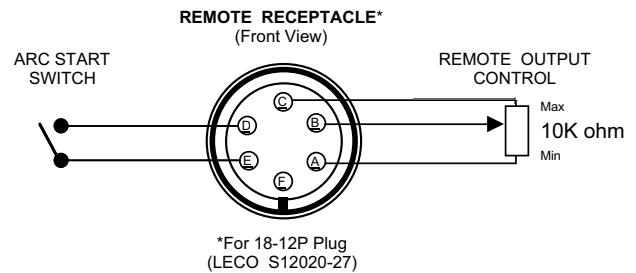

ADVANCED PANEL CONTROLS

The following controls are included only if the Precision TIG 275 has the Advanced Control Panel (K1829-1) option installed: (Refer to Section B-10 Tig Weld Cycle Chart for graphic illustration of these TIG welding functions.)

12. TRIGGER SWITCH – This 2-position switch selects how the arc start switch (connected to the above Remote receptacle) functions; in 2-Step or 4-Step mode:

⚠ CAUTION

- **DO NOT USE 4-STEP IF USING AN AMPTROL REMOTE.**
- **Neither the arc start switch nor the output control in the amptrol will function normally to shut off or control the out put. ONLY USE 2-STEP.**

- In 2-Step position the arc start switch functions the same as without the Advanced Panel:

1. Closing switch starts preflow, then a fixed (0.5 sec.) ramp time from Minimum (Start) setting level (See Item 7) to Weld setting.
2. Opening switch initiates Downslope ramp time setting (See Item 17), from Weld setting to Crater-fill level (See Item 7), which then stops the arc and initiates Postflow time (See Item 9).

Note: See Section B-7 for 2-Step operation during Downslope with Restart feature selected to be disabled, instead of enabled (as shipped).

- In 4-Step position allows welding without continuously holding the start switch trigger. The arc start switch functions in the following manner:
 1. Closing switch starts preflow, then arc starts at Minimum (Start) setting level (See Item 7). If the trigger is maintained closed after preflow time the output remains at the Start level until it is released.
 2. Opening switch initiates fixed (0.5 sec.) ramp time from Start setting level to Weld setting.
 3. Reclosing switch initiates Downslope ramp time setting (See item 17) from Weld setting down to the Crater-fill level (See Item 7) of the machine.
 4. Reopening switch after Downslope time holds Crater-fill level until switch opens, then stops the arc and initiates the Postflow Time (See Item 9). Or, reopening switch during Downslope time immediately stops the arc and initiates the Postflow.

Note: See Section B-7 for 4-Step operation during Downslope with Restart feature selected to be enabled, instead of disabled (as shipped).

13. PULSE MODE SWITCH – Turns on the Pulse Mode as indicated by the Green panel light turning on.

- Pulsing provides a Peak current level set by REMOTE and/or LOCAL control of the output current (See Item 5), for a time determined by the Pulse Frequency Control setting (See Item 14) and the % ON Time (See Item 15). The balance of the cycle time is at the Background Current level (See Item 16).
- Pulsing begins after upslope when the output current rises above the Background Current level and ends when the output current drops below this level.

14. PULSE FREQUENCY CONTROL – This knob is used to set the Pulse Frequency over the peak pulse range of about 0.1 pps to 20 pps. (One pulse cycle time = $1/\text{pps} = 10$ to $.05$ sec. range.)

15. PULSE % ON TIME CONTROL – This knob controls the duration of the peak current as a percentage (5% to 95%) of one pulse cycle. The balance of the cycle time will be at the Background Current setting. (See Item 16)

16. PULSE BACKGROUND CURRENT CONTROL – This knob controls the level of the Background Current as a percentage (MIN.-100%) of the Peak (REMOTE and/or LOCAL) output level (See Item 6) down to the Minimum Output setting (See Item 7).

17. DOWNSLOPE TIME– This knob is used to set the time, over the range of zero to about 10 seconds, to ramp down from weld setting to Crater-fill level (See Item 7).

- If the arc goes out after the Downslope time is initiated, the Downslope time is interrupted and the Postflow time is initiated. This prevents Hi-Freq re-initiation during ramp down crater fill
- When using an Amptrol remote control, where the downslope is controlled by the operator down to the crater-fill level, the Downslope time should be set to zero so as not to have the Downslope time delay when the arc start switch is opened.

INTERNAL SET UP CONTROLS

Precision TIG 275 models which have an Advanced Panel (K1829-1) option installed* have the following additional control features which are set up using the DIP Switch (S1) provided on the internal panel of this option.

Access to this internal panel is obtained by removing the two screws securing the top corners of the Precision TIG front control panel and swinging the control panel down to reveal the panel mounted on the surface of the Precision TIG Control board:

⚠ CAUTION

- **THE CONTROL BOARDS CONTAIN STATIC SENSITIVE COMPONENTS**
- **To avoid possible damage to these components be sure to ground yourself by touching the machine's sheet metal while handling or making settings on the internal control box components.**

PRECISION TIG ADVANCED PANEL (Internal Panel)

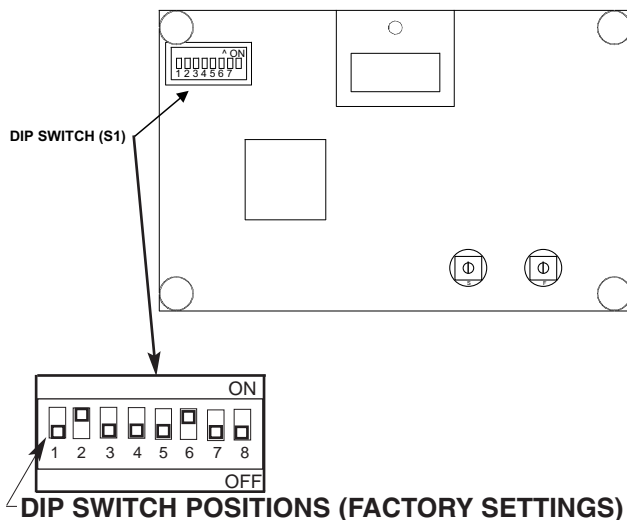

STICK WELDING FEATURES

The following DIP switch feature selections function only when the Precision TIG is set to Stick mode. (See Item 3):

- **Switch #6 Hot Start Level** – Provides an extra output "boost" pulse at the arc strike to enhance arc starting. This is factory set for a level (about 50% extra) which is usually good for most stick welding applications

ON – Hot Start level is used (as shipped).
OFF – No Hot Start.

- **Switch #7 Arc Force Level** – Prevents "sticking" of the electrode by providing extra output current if the arc voltage drops below the level required to sustain the welding arc. High (+65%) and Low (+12%) factory set levels are selectable which are good for most stick welding applications.

ON – Higher for a "crisper" arc, often desired for 6010 type electrodes.

OFF – Lower Arc Force (as shipped) for a "softer" arc with 7018 or general type electrodes.

- **Switch #8 (NOT CURRENTLY FUNCTIONAL)**

TIG WELDING FEATURES

The following DIP switch feature selections function only when the Precision TIG is set to TIG mode (See Item 3):

- **Switch #1 Preflow/Postflow Time Extension*** (See Item 9)

ON – Doubles the time ranges.

OFF – Standard time ranges (as shipped).

- **Switch #2 2-Step Trigger Restart Feature** (See Figure B.3)

ON – Restart Enabled (as shipped).

OFF – Restart Disabled.

- **Switch #3 4-Step Trigger Restart Feature** (See Figure B.4)

ON – Restart Enabled.

OFF – Restart Disabled (as shipped)

- **Switch #4 (NOT CURRENTLY FUNCTIONAL)**

- **Switch #5 Crater-Fill Level** (See Item 7)

ON - Level is minimum rating of the machine (2A)

OFF – Level (as shipped) is Minimum Output setting (same as Start level).

* The Preflow/Postflow Time doubling feature can also be selected on Precision TIG 275 models without the Advanced Panel by accessing the Control board in the control box per above instructions, then disconnecting the jumper terminals attached to the jumper plug connected to receptacle J3 of the Control board. (Refer to Machine Wiring Diagram.)

FIGURE B.3

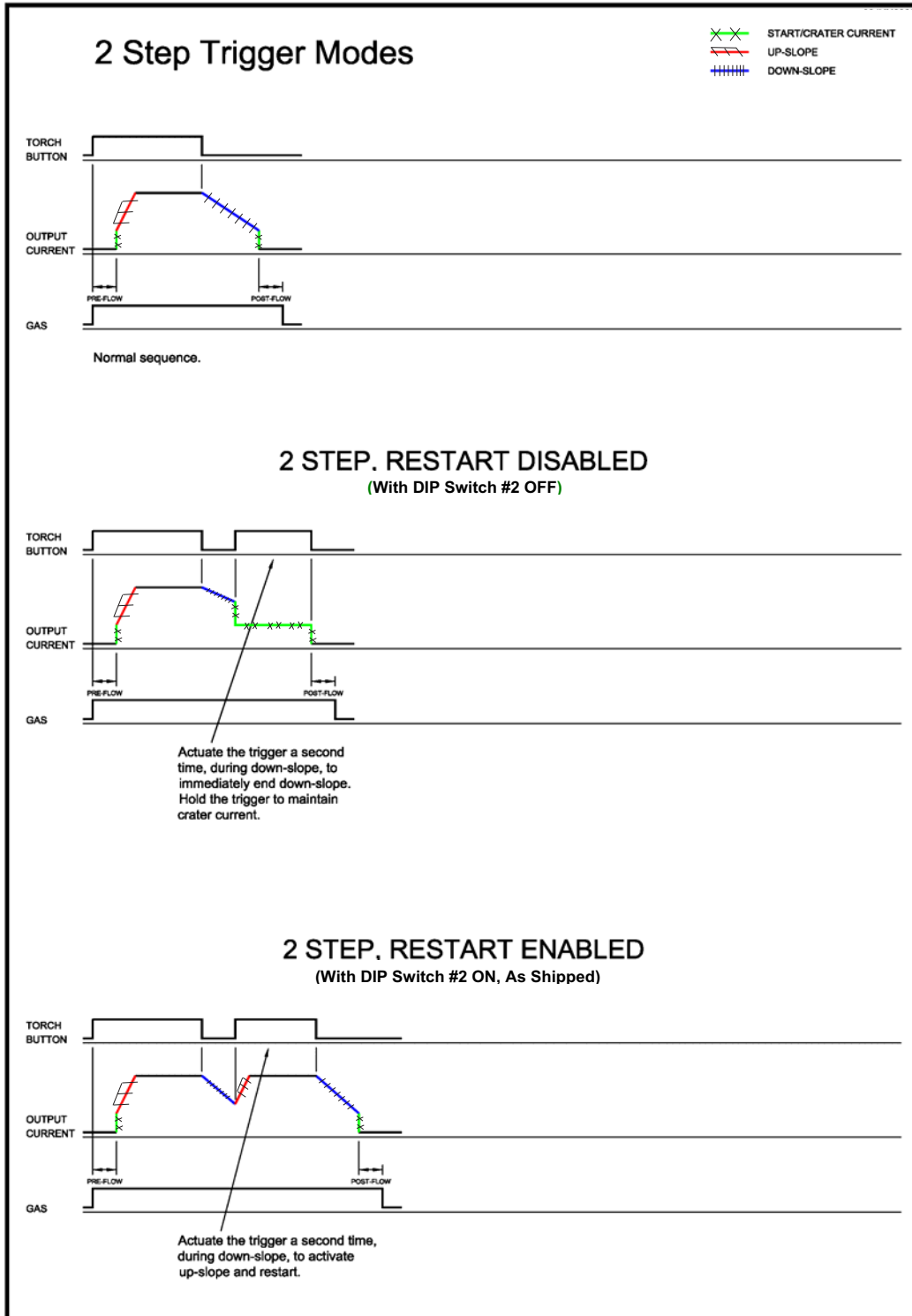
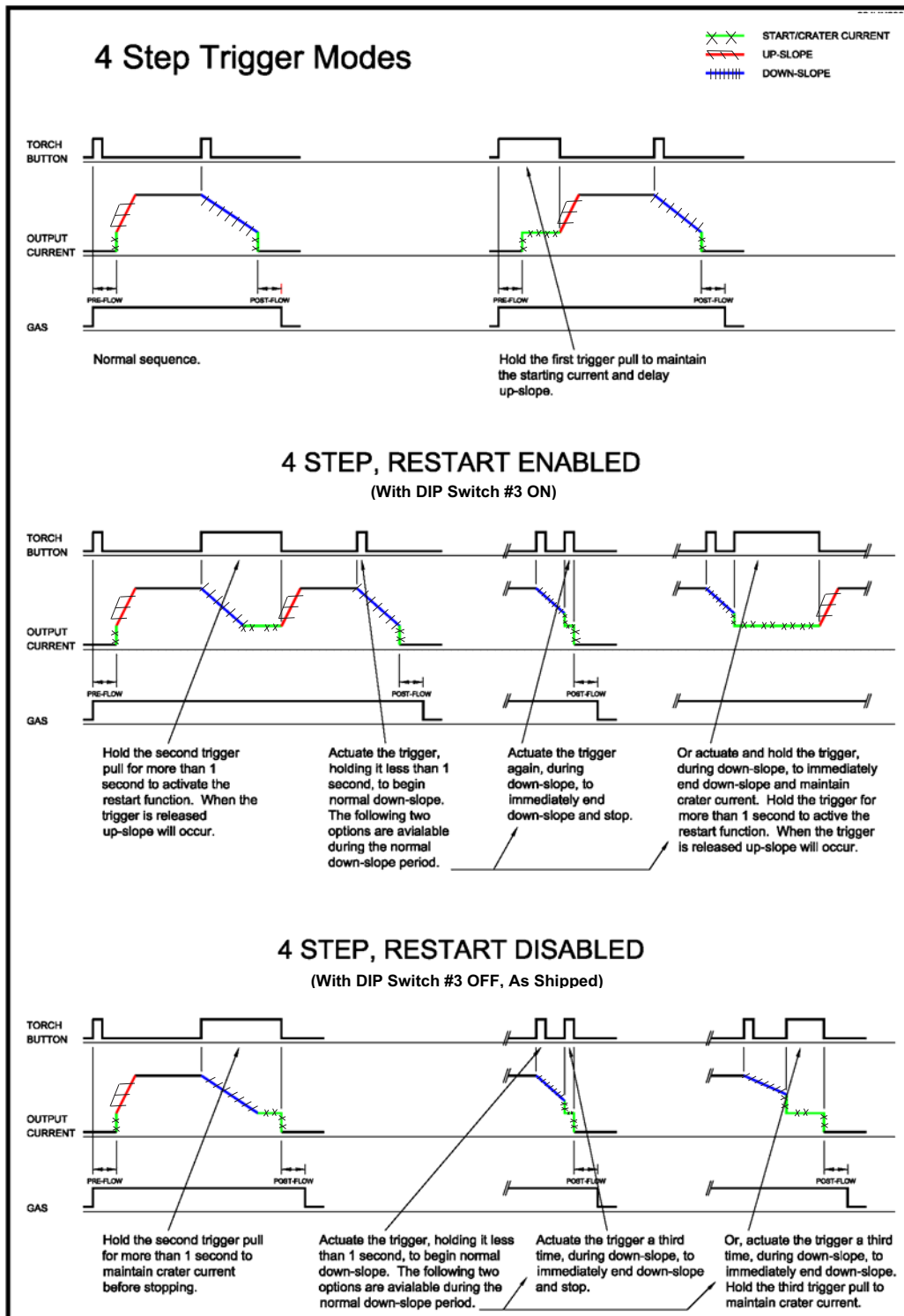
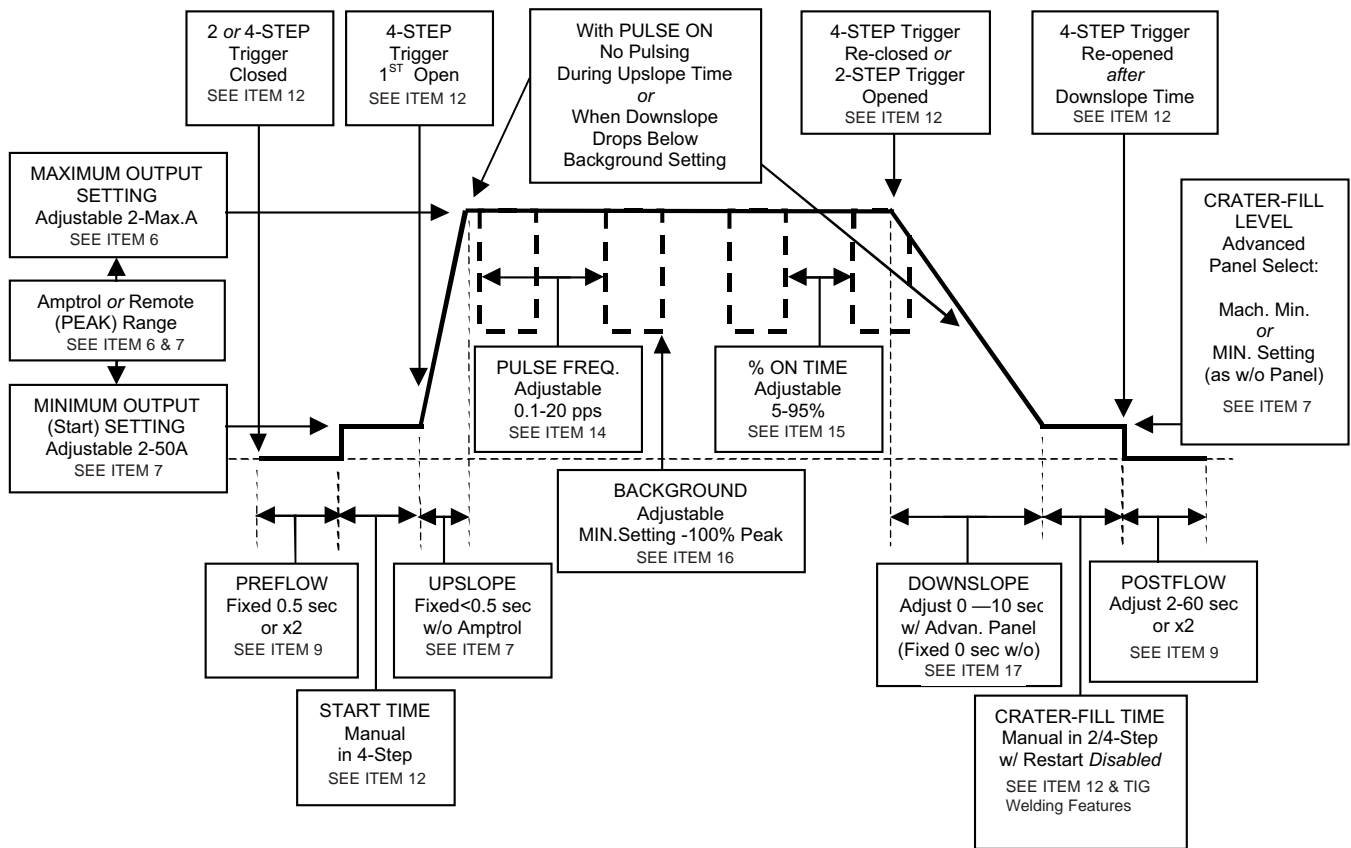

FIGURE B.4



TIG WELD CYCLE CHART



SETUP GUIDELINES FOR TIG WELDING WITH AN AMPCTRL

Both the Hand and Foot **Amptrols** work in a similar manner. They are meant to be used for remote current control for TIG welding using the machine's **2-Step** trigger mode (See Item 12).

The Amptrol is capable of controlling the output of the Precision TIG over the range between the level preset by the **Minimum Output** control when the Amptrol is at its inactivated state, and the level preset by the **Maximum Output** control when the Amptrol is at fully-activated state.

It is important to note that even with the Precision TIG's new **MicroStart™** Technology, some tungstens may be difficult to start at the low (2 amps) minimum rating of the machine. Rather than guessing where to depress the Amptrol to start the arc reliably, the **Minimum Output** control allows presetting the exact level, so reliable starts, as well as minimum crater-fill levels, can be consistently obtained at the minimum Amptrol (inactivated) state. **FIGURE B.6** shows Precision TIG setup for TIG welding with an Amptrol.

USING THE START PEDAL FOOT AMPCTRL (K870-1)

To further enhance reliability of consistently obtaining this minimum level just after the Amptrol's start switch is closed, or just before it opens for crater-fill, the new **K870-1 Start Pedal Foot Amptrol** is available. Its independent start pedal on control pedal provides two-stage foot action to easily feel start switch closure at minimum output level for precise arc start and crater control. Also, an adjustable heel stop helps assure comfortable foot location. (See Figure B.5)

Currently available TIG foot pedal controls combine the arc start switch actuation in the same pedal action with the output control variable resistance. This technique provides no independent tactile feel of where the arc start switch actuates, and at what control level, for consistent TIG starting. Nor does it provide a way for consistent crater-fill control to feel at what decreasing control pedal position the arc start switch will re-open causing arc out.

The new foot pedal provides such independent action distinction of precisely where the arc start switch actuates without over-riding minimum control pedal position, and precisely where the control pedal has been returned to minimum position without inadvertently deactuating the arc start switch. The result is repeatable consistency in TIG weld starting and crater-fill for manual process control.

Using this new foot pedal with the Precision TIG's new presettable Minimum Output level, in addition to the presettable Maximum Output level, further enhances the starting and crater level consistency as well as the control resolution of the manually controlled foot pedal.

FIGURE B.5

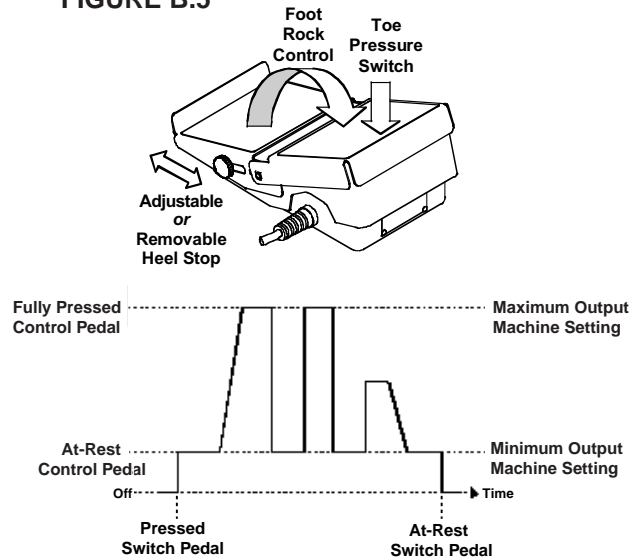
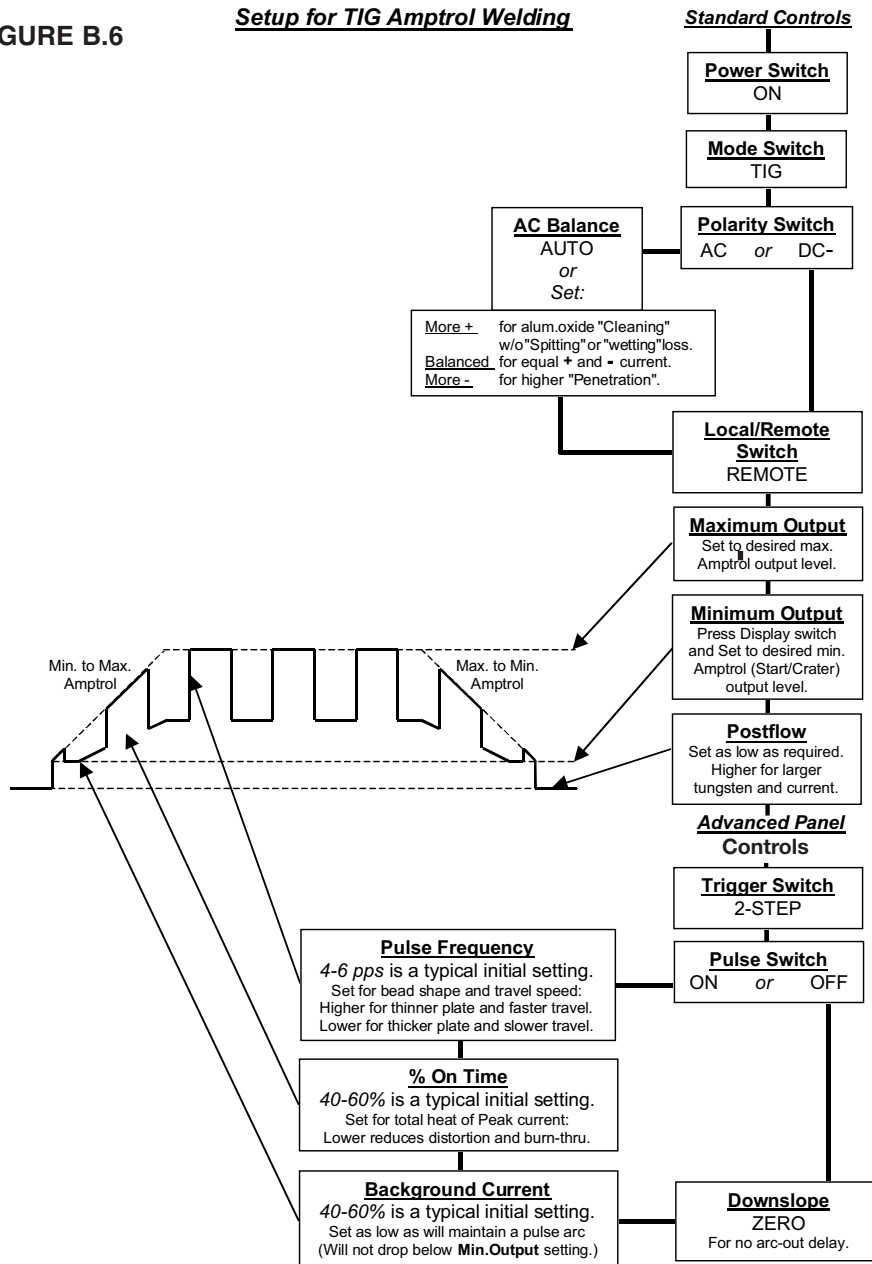

FIGURE B.6

Setup for TIG Amptrol Welding



PRECISION TIG 275



MAKING A TIG WELD WITH AN AMPCTRL

1. Install welding equipment per Section A-5.
2. Setup controls per Section B-10.
3. Turn on the shielding gas supply, and torch coolant input supply (if used).

Note: The Precision TIG Under-Cooler (or Water Solenoid connected to the Cooler receptacle) runs with the Fan-As-Needed machine cooling fan (See Maintenance Section D), so the cooler fan and water pump will also not run continuously in idle, but will run while welding.

4. With the torch held safely away from everything, close the Arc Start Switch of the Ampctrl and set the gas flow meter. Then open the switch. The welder is now ready for welding.
5. Position the tungsten electrode at the start of the weld at a 65° to 75° angle with the horizontal, in the direction of pushing travel, so that the electrode is approximately 1/8" (4 mm) above the work piece.

Close the arc start switch. This opens the gas valve to automatically purge air from the hose and torch, then shields the arc strike area. After the 0.5 second preflow time, the high frequency becomes available to strike the arc. When the arc strikes the torch coolant (if used) starts to flow. Also, if welding DC- TIG, the high frequency shuts off just after the arc strikes.

6. Hold the arc start switch closed at minimum Ampctrl Start level (See Section B-10) until an arc is established, then increase the output to the desired welding level and push the torch in the direction of travel.
7. At the end of the weld, decrease the Ampctrl output to the crater-fill level before releasing the arc start switch to start the Postflow time. Hold the torch gas shielding over the solidifying weld crater while post-flow time expires and the gas valve reopens. The torch coolant (if used) continues to flow for up to 8 minutes after the arc goes out (with the Fan-As-Needed feature) to assure torch cooling.
 - Repeat steps 5 through 7 to make another weld.

RECOMMENDED ELECTRODE AMPERAGE RANGES - PRECISION TIG 275

SMAW Process

ELECTRODE	POLARITY	3/32"	1/8"	5/32"
Fleetweld 5P, Fleetweld 5P+	DC+	40 - 70	75 - 130	90 - 175
Fleetweld 180	DC+	40 - 80	55 - 110	105 - 135
Fleetweld 37	DC+	70 - 95	100 - 135	145 - 180
Fleetweld 47	DC-	75 - 95	100 - 145	135 - 200
Jet-LH MR	DC+	85 - 110	110 - 160	130 - 220
Blue Max Stainless	DC+	40 - 80	75 - 110	95 - 110
Red Baron Stainless	DC+	40 - 70	60 - 100	90 - 140

Mild steel procedures are based on recommended procedures listed in C2.10 8/94 and the maximum rating of the PRECISION TIG 275
 Excaliber 7018 procedures are based on Jet-LH 78 MR
 Blue Max procedures are based on C6.1 6/95
 Red Baron Procedure are based on ES-503 10/93

GTAW Process

Electrode Polarity		DC-		AC*		Approximate Argon Gas Flow Rate C.F.H. (l/min.)	
Electrode Tip Preparation		Sharpened		Balled			
Electrode Type		EWTh-1, EWCe-2 EWTh-2, EWLa-1 EWG		EWP	EWZr EWTh-1, EWTh-2 EWCe-2, EWLa-1 EWG	Aluminum	Stainless Steel
Electrode Size (in.)							
.010		Up to 15 A.	Up to 15 A.	Up to 15 A.	Up to 15 A.	3-8 (2-4)	3-8 (2-4)
.020		Up to 15 A.	10 to 15 A.	5 to 20 A.	5-10 (3-5)	5-10 (3-5)	
.040		Up to 80 A.	20 to 30 A.	20 to 60 A.	5-10 (3-5)	5-10 (3-5)	
1/16		Up to 150 A.	30 to 80 A.	60 to 120 A.	5-10 (3-5)	9-13 (4-6)	
3/32		Up to MAX. A.	60 to 130 A.	100 to 180 A.	13-17 (6-8)	11-15 (5-7)	
1/8	X		100 to 180 A.	160 to 250 A.	15-23 (7-11)	11-15 (5-7)	

Tungsten electrodes are classified as follows by the American Welding Society (AWS):

- PureEWP.....green
- +1% ThoriumEWTh-1.....yellow
- +2% ThoriumEWTh-2.....red
- +2% CeriumEWCe-2orange
- +1.5% LanthanaEWLa-1black
- +0.15 to 0.40% ZirconiaEWZr.....brown

Ceriated Tungsten is now widely accepted as a substitute for 2% Thoriated Tungsten in AC and DC applications.

*Balanced Wave, Unbalanced Wave requires derating of the electrode.

PRECISION TIG 275



OPTIONAL EQUIPMENT

FACTORY INSTALLED OPTIONS

The basic Precision TIG 275 machine is factory equipped with:

- A 3/8" Adapter (S20403-4) for air cooled torch connection of a PTA-9 or PTA-17.

Accessories that are factory installed with the Domestic model (K1826-1) to make up the Domestic Welding Package (K1825-1) include:

- K1828-1 Under-Cooler Cart
- 3100211 Harris Argon Flow Regulator with 10' hose.
- K870 Foot Amptrol
- K1784-4 25' PTW-20 water-cooled TIG Torch
- K918-2 Zippered Torch Cover
- KP510 Parts Kit for Torch
- K2150-1 Work Lead Assembly

See below for more detailed descriptions.

FIELD INSTALLED OPTIONS

The following Options/Accessories are available for the Precision TIG 275 and are installed per instructions in this manual and / or provided in the package:

- K1829-1 Precision TIG Advanced Control Panel Provides 2/4-step trigger with adjustable Pulser controls and Down slope timer for TIG welding. Also includes adjustable Hot Start and Arc Force internal panel controls for Stick welding, and other user selectable features.
- K1828-1 Under-Cooler Cart Includes a "cooler-in-a-drawer" with hoses and a lockable storage drawer on a dual bottle undercarriage (see below).
- K1869-1 Undercarriage Includes a dual bottle rack with chain and an undercarriage with 5" front casters, 10" rear wheels and a handle.
- K1830-1 Water Solenoid Kit Provides for stopping flow of external water supply. Connects to coolant inlet and cooler receptacle of Precision TIG. (Can not be used with a water cooler.)
- K870 Foot Amptrol Single pedal foot activation of arc start switch and output control, with 25' plug cable.

- K870-1 Start Pedal Foot Amptrol Independent start pedal on control pedal provides two-stage foot action to easily feel start switch closure at minimum output level for enhanced arc start and crater-fill control. Provided with adjustable, or removable, heel stop and 25' plug cable. (Refer to Figure B.5)

- K963-3 Hand Amptrol Fastens to torch for convenient thumb activation of arc start switch and output control, with 25' plug cable:

- K814 Arc Start Switch Needed for TIG welding without an Amptrol. Includes 25' plug cable, and attaches to torch for convenient finger control.

- K1831-1 Power Factor Capacitor Kit Used when welding at higher output currents to reduce input current and help keep electricity costs to a minimum.

• **Magnum® PTA and PTW Series Torches**

All Air Cooled or Water-Cooled Magnum® TIG Torches may be used with the PRECISION TIG 275. Connection adapters are only required for Air-Cooled Torches (Refer to Diagrams on A-7):

K2166-1 7/8" Torch Connector for PTA-26 (one piece)

K2166-2 1/2" stud Connector for PTA Torch (two-piece).

K2166-3 3/8" TIG Torch Connector for PTA-9,-17 (one piece). (Included as S20403-4 with Precision TIG models.)

- 3100211 Harris Argon Flow Regulator (Includes 10' hose.)
- K2150-1 Work Lead Assembly 15ft. 2/0 cable with 1/2" stud lug and work clamp.

SAFETY PRECAUTIONS

⚠ WARNING



ELECTRIC SHOCK can kill.

- Only qualified personnel should perform this maintenance.
- Turn the input power **OFF** at the disconnect switch or fuse box before working on this equipment.
- Do not touch electrically hot parts.

⚠ WARNING

To avoid receiving a high frequency shock, keep the TIG torch and cables in good condition.

ROUTINE AND PERIODIC MAINTENANCE

Very little routine maintenance is necessary to keep your Precision TIG 275 running in top condition. No specific schedule can be set for performing the following items; factors such as hours of usage and machine environment should be considered when establishing a maintenance schedule.

- Periodically blow out dust and dirt which may accumulate within the welder using an air stream.
- Inspect welder output and control cables for fraying, cuts, and bare spots.
- Inspect the spark gap at regular intervals to maintain the recommended spacing. See the Service Procedures (See Service Procedures in this Section) for complete information on spark gap settings.
- The fan motor has sealed ball bearings which require no maintenance.
Overload Protection

OVERLOAD PROTECTION

FAN-AS-NEEDED (F.A.N.)

The Precision TIG 275 has the F.A.N. circuit feature, which means the cooling fan will operate only while welding; then for about 8 minutes after welding has stopped to assure proper machine cooling. This helps reduce the amount of dust and dirt drawn into the machine with the cooling air. The cooling fan will operate briefly when the machine power is initially turned on, and continuously while the yellow Thermal Shutdown Light is lit (see Thermostatic Protection).

THERMOSTATIC PROTECTION

This welder has thermostatic protection from excessive duty cycles, overloads, loss of cooling, and excessive ambient temperatures. When the welder is subjected to an overload, or inadequate cooling, the primary coil thermostat and/or secondary coil thermostat will open. This condition will be indicated by the illumination of the yellow Thermal Shutdown Light on the front panel (see Item 10 in Section B). The fan will continue to run to cool the power source. Postflow occurs when TIG welding is shut down, but no welding is possible until the machine is allowed to cool and the yellow Thermal Shutdown Light goes out.

NO ARC PROTECTION

The machine outputs (Background / OCV, gas and HF) will be shutdown, if the trigger is closed without welding for 15 seconds to protect the Background resistor from overheating with F.A.N. cooling off, as well as to conserve on gas waste.

AUXILIARY POWER CIRCUIT BREAKER

The 115vac auxiliary circuits and rear receptacle (see Section A Auxiliary Power Connections) are protected from overloads by a 15 amp circuit breaker, located above the receptacle. If the breaker trips its button pops out exposing a red ring. When the circuit breaker cools the button can be reset by pressing it back in. Note: When the breaker trips not only will the receptacle's auxiliary and cooler power be interrupted, but so will the power to the shielding gas solenoid and machine cooling fan.

The **Export models** also include a 5 amp circuit breaker, located on the opposite side of the upper case back, for protection of the 220vac Schuko type cooler receptacle.

SERVICE PROCEDURES

Operation of the Precision TIG should be trouble-free for the life of the machine. Should a malfunction occur, however, the following procedures will be useful to trained service personnel with experience in repairing arc welding equipment:

COMPONENT ACCESS

The following components are accessible for routine set up and periodic service without requiring removal of the case sides or roof:

- **Input Reconnect Panel** (refer Section A) is located behind a removable panel on the rear of the left case side. Remove the two screws (with a screwdriver or a 3/8" / 9.5mm hex driver) on the bottom corners of this panel to remove it.
- Control Box components and PC Boards (refer Section B-6) are located behind the front control panel. Remove the two screws (with a screwdriver or a 3/8" / 9.5mm hex driver) on the top corners of this panel to swing it down.
- Hi-Freq. Spark Gap assembly (refer Spark Gap Adjustment) is located behind a removable panel on the rear of the right case side, under the torch box. Remove the screw (with a screwdriver or a 3/8" / 9.5mm hex driver) on the bottom center of this panel to remove it.

SPARK GAP ADJUSTMENT

The spark gap is set at the factory to a gap of 0.015 inches (0.4 mm) See Figure C.1. This setting is adequate for most applications. Where less high frequency is desired, the setting can be reduced to 0.008 inches (0.2 mm).

WARNING

Use extreme caution when working with circuit of the high frequency. The high voltages developed can be lethal. Turn the input power off using the disconnect switch or fuse box before working inside the machine. This is particularly important when working on the secondary circuit of the high voltage transformer (T3) because the output voltage is dangerously high.

FIGURE C.1 SPARK GAP

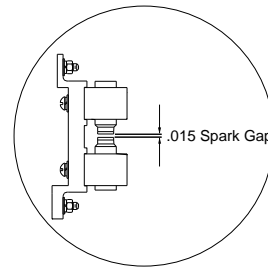

Note: In highly dirty environments where there is an abundance of conductive contaminants, use a low pressure air stream or a firm piece of paper to clean out the spark gap. Do not disturb the factory gap setting.

To check the spark gap:

1. Turn the input power off per above.
2. Remove the access panel on the right case side (See Component Access).
3. Check the spark gap spacing with a feeler gauge.

If adjustment is required:

1. Adjust the gap by loosening the Allen head screw on one of the aluminum blocks, reset the gap and tighten the screw in the new position.

If spark gap is correct:

1. Reinstall the access panel on the right case side.

UNDER-COOLER SERVICE

The required maintenance and service instructions for the Under-Cooler are provided in the operator's manual (IM723) provided with the Under-Cooler Cart.

HOW TO USE TROUBLESHOOTING GUIDE

WARNING

Service and Repair should only be performed by Lincoln Electric Factory Trained Personnel. Unauthorized repairs performed on this equipment may result in danger to the technician and machine operator and will invalidate your factory warranty. For your safety and to avoid Electrical Shock, please observe all safety notes and precautions detailed throughout this manual.

This Troubleshooting Guide is provided to help you locate and repair possible machine malfunctions. Simply follow the three-step procedure listed below.

Step 1. LOCATE PROBLEM (SYMPTOM).

Look under the column labeled “PROBLEM (SYMPTOMS)”. This column describes possible symptoms that the machine may exhibit. Find the listing that best describes the symptom that the machine is exhibiting.

Step 2. POSSIBLE CAUSE.

The second column labeled “POSSIBLE CAUSE” lists the obvious external possibilities that may contribute to the machine symptom.

Step 3. RECOMMENDED COURSE OF ACTION

This column provides a course of action for the Possible Cause, generally it states to contact your local Lincoln Authorized Field Service Facility.

If you do not understand or are unable to perform the Recommended Course of Action safely, contact your local Lincoln Authorized Field Service Facility.

CAUTION

DO NOT use a volt-ohm meter to measure output voltages in TIG mode. The High Frequency Arc Starter voltage can damage the meter.

CAUTION

If for any reason you do not understand the test procedures or are unable to perform the tests/repairs safely, contact your **Local Lincoln Authorized Field Service Facility** for technical troubleshooting assistance before you proceed.

Observe all Safety Guidelines detailed throughout this manual

PROBLEMS (SYMPTOMS)		POSSIBLE CAUSE	RECOMMENDED COURSE OF ACTION
OUTPUT PROBLEMS			
Thermal light comes on		<ol style="list-style-type: none"> 1. Thermal shut down. Dirt and dust may have clogged the cooling channels inside machine; air intake and exhaust louvers may be blocked; welding application may exceed recommended duty cycle. Wait until machine cool down and thermal light goes out. Blow out machine with clean, dry low pressure air; check air intake and louvers; stay within recommended duty cycle. 2. Bad thermostat or its connections 	<p>If all recommended possible areas of misadjustment have been checked and the problem persists, Contact your local Lincoln Authorized Field Service Facility.</p>
Meter doesn't light up		<ol style="list-style-type: none"> 1. Losing AC supply to Control PC board 2. Loosing input to machine 3. Faulty Control PC board 	
Has output in Stick mode but no output in Tig mode	No gas & no hi-freq	<ol style="list-style-type: none"> 1. Faulty trigger or hand/foot Amptrol or connections. 2. Faulty Protection PC board or bad connection to Control PC board 3. Losing trigger supply to Control PC board 	
	Gas & hi-freq are o.k.	<ol style="list-style-type: none"> 1. Faulty Control PC board 	
No output in both Stick and Tig modes		<ol style="list-style-type: none"> 1. Bad connection at P4 of Control PC board 2. Faulty Control PC board 	

CAUTION

If for any reason you do not understand the test procedures or are unable to perform the tests/repairs safely, contact your **Local Lincoln Authorized Field Service Facility** for technical troubleshooting assistance before you proceed.

PRECISION TIG 275



Observe all Safety Guidelines detailed throughout this manual

PROBLEMS (SYMPTOMS)	POSSIBLE CAUSE	RECOMMENDED COURSE OF ACTION
METER PROBLEMS		
Meter does not light up	<ol style="list-style-type: none"> 1. Bad meter or its connection 2. Bad connection at P8 of Control PC board 3. Faulty Control PC board 	<p>If all recommended possible areas of misadjustment have been checked and the problem persists, Contact your local Lincoln Authorized Field Service Facility.</p>
Meter does not display V (Volt) or Min A (Minimum current)	<ol style="list-style-type: none"> 1. Bad Display switch or its connection 2. Bad connection at P9 of Control PC board 	
GAS PROBLEMS		
No gas	<ol style="list-style-type: none"> 1. Circuit breaker CB1 open. Press CB1 in to reset 2. Bad connection at P12 of Control PC board 3. Faulty gas solenoid valve SV1 or its connection 4. Faulty Control PC board 	<p>If all recommended possible areas of misadjustment have been checked and the problem persists, Contact your local Lincoln Authorized Field Service Facility.</p>
No control on post flow time	<ol style="list-style-type: none"> 1. Faulty potentiometer R3 or its connection 2. Bad connection at P9 of Control PC board 	
Pre flow & Post flow time too long	<ol style="list-style-type: none"> 1. If an Advanced Control PC board was installed, check setting of DIP switch on that board 2. Missing plug P3 on Control board or bad connection at P3 when an Advanced Control PC board is not present 	

⚠ CAUTION

If for any reason you do not understand the test procedures or are unable to perform the tests/repairs safely, contact your **Local Lincoln Authorized Field Service Facility** for technical troubleshooting assistance before you proceed.

PRECISION TIG 275



Observe all Safety Guidelines detailed throughout this manual

PROBLEMS (SYMPTOMS)	POSSIBLE CAUSE	RECOMMENDED COURSE OF ACTION
HI-FREQ PROBLEMS		
No hi-freq	<ol style="list-style-type: none"> 1. Circuit breaker CB1 open 2. Bad connection at P12 of Control PC board 3. Spark gaps shorted 4. Faulty Control PC board 	<p>If all recommended possible areas of misadjustment have been checked and the problem persists, Contact your local Lincoln Authorized Field Service Facility.</p>
Hi-freq intensity too weak	<ol style="list-style-type: none"> 1. Dirty spark gap or improper gap setting 2. Faulty Arc Starter assembly 	
Hi-freq on continuously in DC Tig	<ol style="list-style-type: none"> 1. Bad connection at P11 of Control PC board 2. Micro-switch S2A is not engaged & disengaged properly when switching between DC & AC polarity. (S2A locates on the Polarity switch) 3. Faulty Control PC board 	
Hi-freq shuts off after starting in AC Tig	<ol style="list-style-type: none"> 1. Micro-switch S2A is not engaged & disengaged properly when switching between DC & AC polarity. (S2A locates on the Polarity switch) 	

⚠ CAUTION

If for any reason you do not understand the test procedures or are unable to perform the tests/repairs safely, contact your **Local Lincoln Authorized Field Service Facility** for technical troubleshooting assistance before you proceed.

PRECISION TIG 275



Observe all Safety Guidelines detailed throughout this manual

PROBLEMS (SYMPTOMS)	POSSIBLE CAUSE	RECOMMENDED COURSE OF ACTION
PRESET & OUTPUT CONTROL PROBLEMS		
Meter does not display preset	<ol style="list-style-type: none"> 1. Faulty potentiometer R1 or its connection 2. Bad connection at P9 of Control PC board 3. Faulty Advanced Control PC board (if present) or its connection to the main Control PC board 4. Missing plug P3 on Control board or bad connection at P3 when an Advanced Control PC board is not present 	<p>If all recommended possible areas of misadjustment have been checked and the problem persists, Contact your local Lincoln Authorized Field Service Facility.</p>
High output current in both DC & AC polarities regardless of preset	<ol style="list-style-type: none"> 1. Bad connection at P6 of Control PC board 2. Bad shunt connection 3. Faulty Control PC board 4. Faulty SCR bridge 	
High output current in DC polarity regardless of preset, o.k. in AC polarity	<ol style="list-style-type: none"> 1. Shorted free wheeling diode D1 	
In 2-step Tig, output stays on for more than downslope time after trigger open (machine with Advanced Control panel only)	<ol style="list-style-type: none"> 1. Bad 2/4 step switch or its connection 2. Bad connection at P1 of Advanced Control PC board 	
Output stays on after releasing hand/foot Amptrol (machine with Advanced Control panel only)	<ol style="list-style-type: none"> 1. Downslope is not set at min. 2. Bad Downslope potentiometer R12 or its connection 	

 **CAUTION**

If for any reason you do not understand the test procedures or are unable to perform the tests/repairs safely, contact your **Local Lincoln Authorized Field Service Facility** for technical troubleshooting assistance before you proceed.

PRECISION TIG 275



Observe all Safety Guidelines detailed throughout this manual

PROBLEMS (SYMPTOMS)	POSSIBLE CAUSE	RECOMMENDED COURSE OF ACTION
STICK WELDING PROBLEMS		
Stick electrode "blast off" when arc is struck	<ol style="list-style-type: none"> 1. Current may be set too high for electrode size 2. (Machine with Advanced Control PC board only) Hot Start level set too high 	If all recommended possible areas of misadjustment have been checked and the problem persists, Contact your local Lincoln Authorized Field Service Facility.
Stick electrode "sticks" in the weld puddle	<ol style="list-style-type: none"> 1. Current may be set too low for electrode size 2. (Machine with Advanced Control PC board only) Arc Force level set too low 	
TIG WELDING PROBLEMS		
Poor starting in DC polarity	<ol style="list-style-type: none"> 1. Input line may be too low 2. Bad connection at P11 of Control PC board 3. Bad Background rectifier, background resistor R7, or background diode D2 	If all recommended possible areas of misadjustment have been checked and the problem persists, Contact your local Lincoln Authorized Field Service Facility.
Arc "flutters" in DC polarity, o.k. in AC polarity	<ol style="list-style-type: none"> 1. Tungsten not "sharp" 2. Bad free wheeling diode D1 or its connection 	
Arc "flutters" in both DC & AC polarities	<ol style="list-style-type: none"> 1. Tungsten electrode may be too large in diameter for the current setting 2. Gas shielding may be insufficient. 3. Contaminated gas or leaks in the gas line, torch, or connections 4. Helium blend is used as a shielding gas 	

 **CAUTION**

If for any reason you do not understand the test procedures or are unable to perform the tests/repairs safely, contact your **Local Lincoln Authorized Field Service Facility** for technical troubleshooting assistance before you proceed.

PRECISION TIG 275



Observe all Safety Guidelines detailed throughout this manual

PROBLEMS (SYMPTOMS)	POSSIBLE CAUSE	RECOMMENDED COURSE OF ACTION
TIG PROBLEMS		
Arc "pulsates" in AC polarity, DC polarity is o.k.	1. Micro switch S2A on polarity switch does not open in AC polarity	If all recommended possible areas of misadjustment have been checked and the problem persists, Contact your local Lincoln Authorized Field Service Facility.
Black area along weld bead	1. Oily or organic contamination from work piece 2. Tungsten electrode may be contaminated 3. Leaks in gas line, torch, or connections	
Output quits momentarily; gas flow and hi-freq are also interrupted	1. May be caused by hi-freq interference. Check that machine is grounded properly. Surrounding machines that generate hi-freq also should be properly grounded. 2. Ground connection of Protection PC board may have become loose 3. Ground connection of Bypass/Stabilizer PC board may have become loose.	

 **CAUTION**

If for any reason you do not understand the test procedures or are unable to perform the tests/repairs safely, contact your **Local Lincoln Authorized Field Service Facility** for technical troubleshooting assistance before you proceed.

PRECISION TIG 275



PRECISION TIG 275 WIRING DIAGRAM FOR CODE: 10806

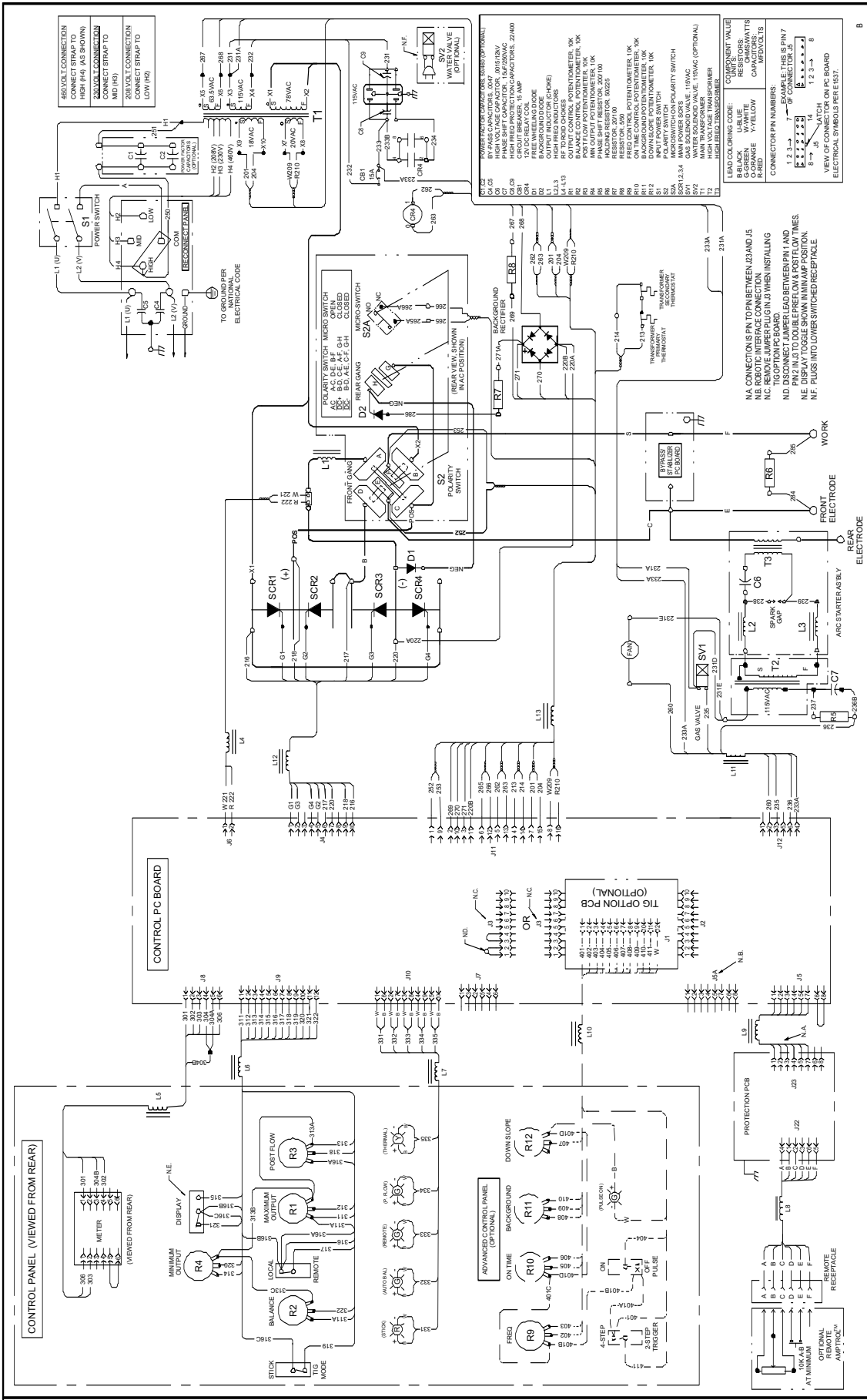

G4031

NOTE: This diagram is for reference only. It may not be accurate for all machines covered by this manual. The specific diagram for a particular code is pasted inside the machine on one of the enclosure panels. If the diagram is illegible, write to the Service Department for a replacement. Give the equipment code number..

PRECISION TIG 275



PRECISION TIG 275 WIRING DIAGRAM FOR CODE: 10807

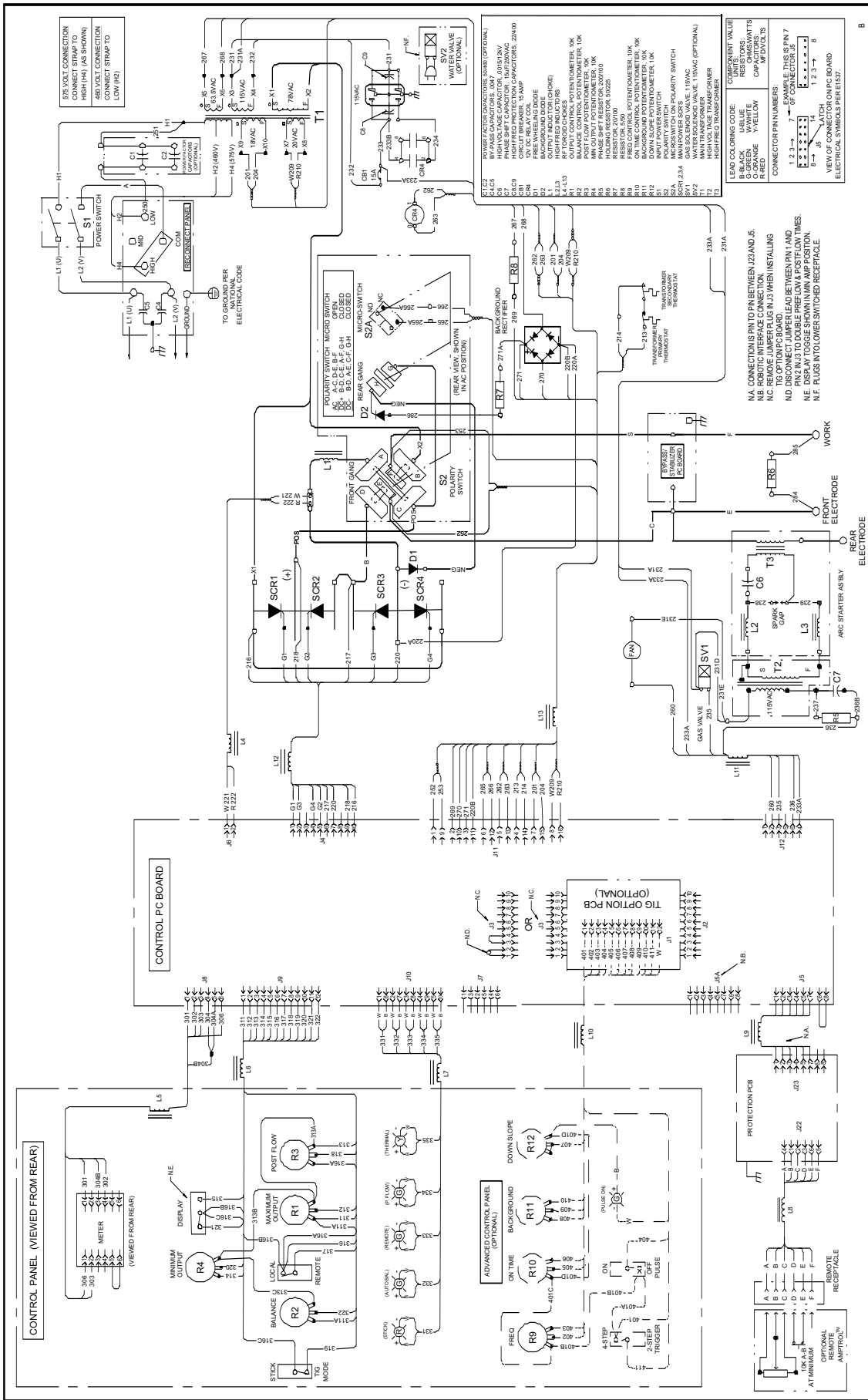

G4031-1

NOTE: This diagram is for reference only. It may not be accurate for all machines covered by this manual. The specific diagram for a particular code is pasted inside the machine on one of the enclosure panels. If the diagram is illegible, write to the Service Department for a replacement. Give the equipment code number..

PRECISION TIG 275



PRECISION TIG 275 WIRING DIAGRAM FOR CODE: 10893

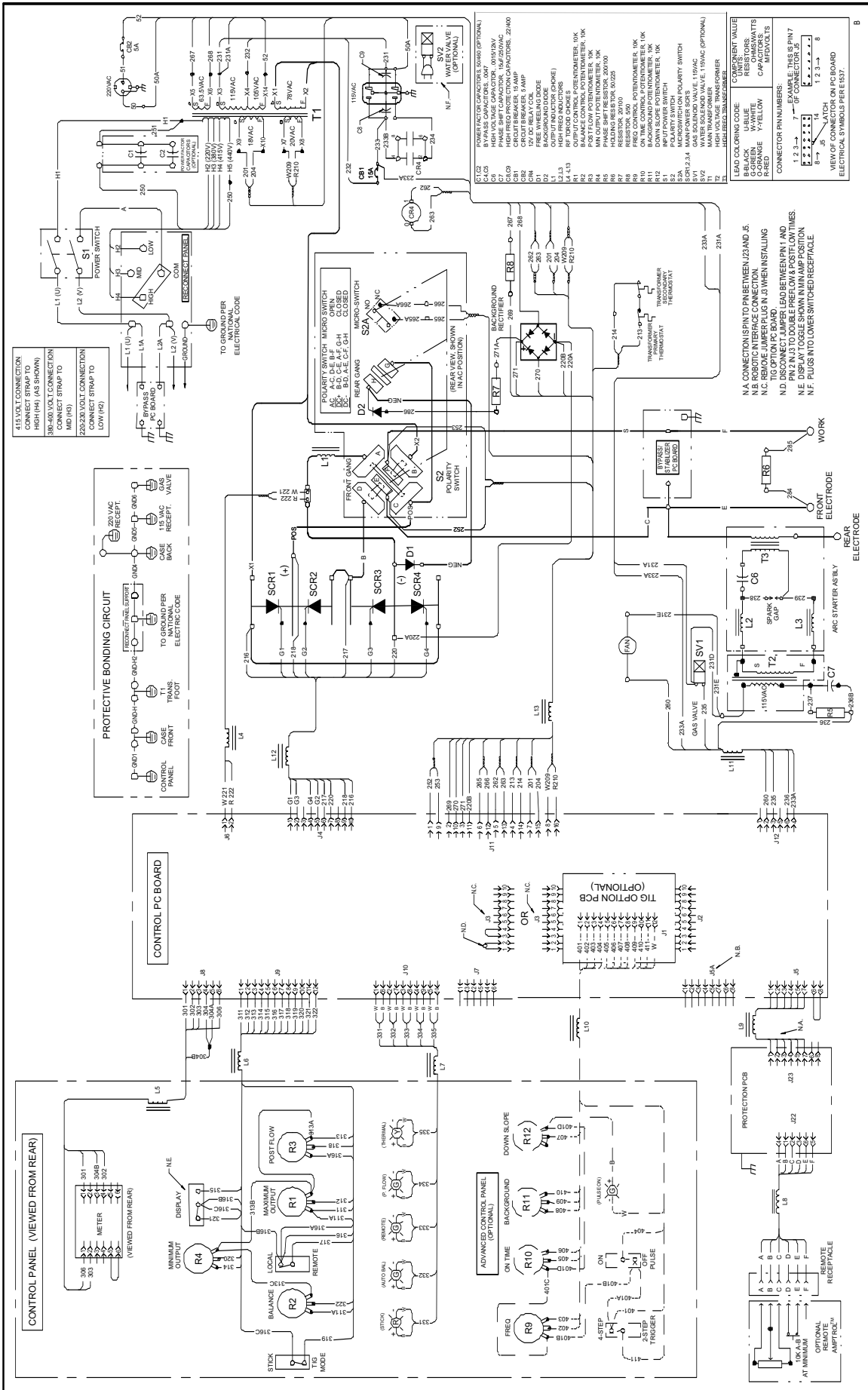

G4031-2

NOTE: This diagram is for reference only. It may not be accurate for all machines covered by this manual. The specific diagram for a particular code is pasted inside the machine on one of the enclosure panels. If the diagram is illegible, write to the Service Department for a replacement. Give the equipment code number.

PRECISION TIG 275



K1825-1 DOMESTIC PACKAGE

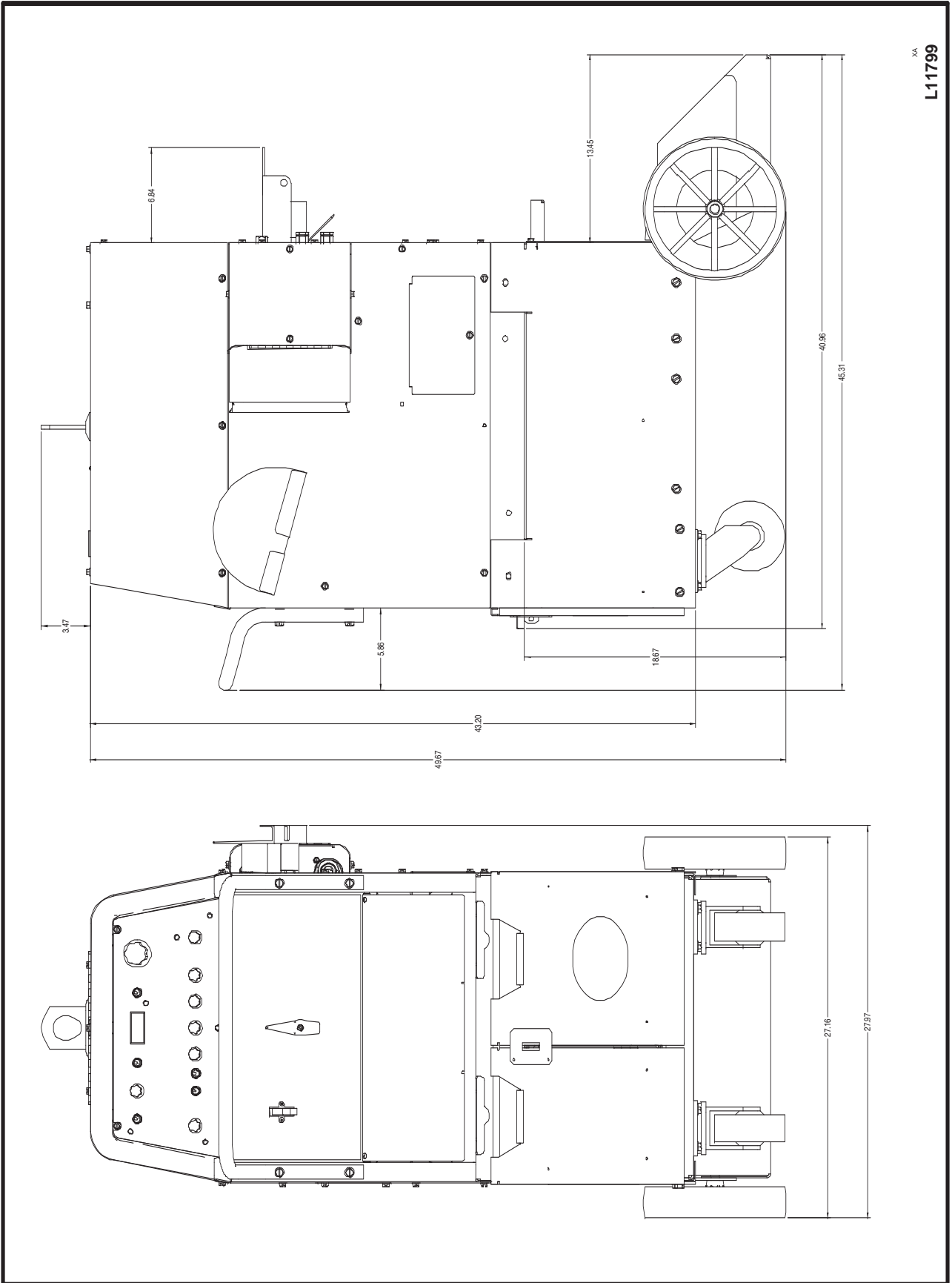

PRECISION TIG 275



K1826-1 DOMESTIC, K1826-2 CANADA AND K1827-1 EXPORT

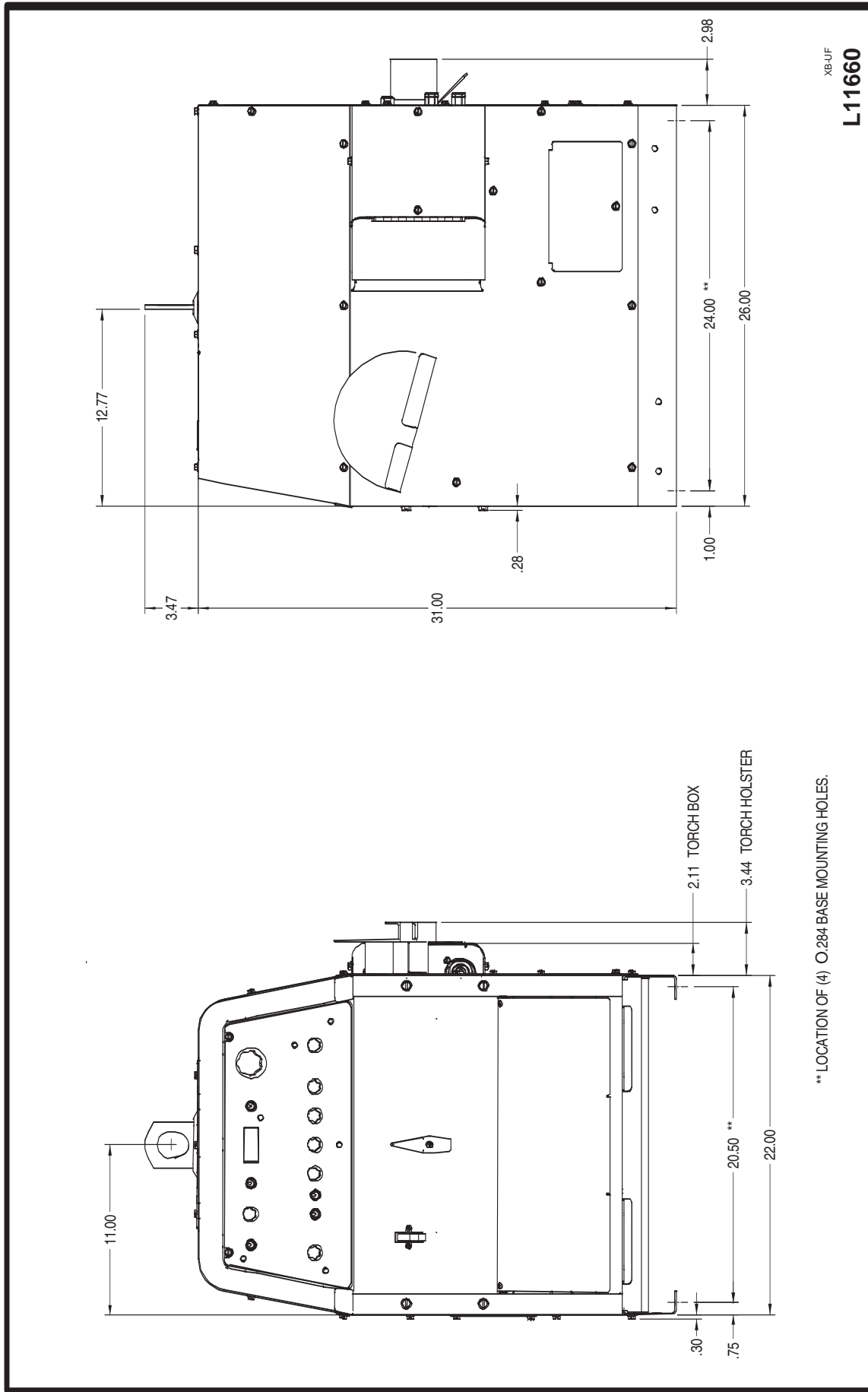

** LOCATION OF (4) Ø.284 BASE MOUNTING HOLES.

PRECISION TIG 275



NOTES

PRECISION TIG 275



WARNING	<ul style="list-style-type: none"> Do not touch electrically live parts or electrode with skin or wet clothing. Insulate yourself from work and ground. 	<ul style="list-style-type: none"> Keep flammable materials away. 	<ul style="list-style-type: none"> Wear eye, ear and body protection.
Spanish AVISO DE PRECAUCION	<ul style="list-style-type: none"> No toque las partes o los electrodos bajo carga con la piel o ropa mojada. Aíslese del trabajo y de la tierra. 	<ul style="list-style-type: none"> Mantenga el material combustible fuera del área de trabajo. 	<ul style="list-style-type: none"> Protéjase los ojos, los oídos y el cuerpo.
French ATTENTION	<ul style="list-style-type: none"> Ne laissez ni la peau ni des vêtements mouillés entrer en contact avec des pièces sous tension. Isolez-vous du travail et de la terre. 	<ul style="list-style-type: none"> Gardez à l'écart de tout matériel inflammable. 	<ul style="list-style-type: none"> Protégez vos yeux, vos oreilles et votre corps.
German WARNUNG	<ul style="list-style-type: none"> Berühren Sie keine stromführenden Teile oder Elektroden mit Ihrem Körper oder feuchter Kleidung! Isolieren Sie sich von den Elektroden und dem Erdboden! 	<ul style="list-style-type: none"> Entfernen Sie brennbares Material! 	<ul style="list-style-type: none"> Tragen Sie Augen-, Ohren- und Körperschutz!
Portuguese ATENÇÃO	<ul style="list-style-type: none"> Não toque partes elétricas e electrodos com a pele ou roupa molhada. Isole-se da peça e terra. 	<ul style="list-style-type: none"> Mantenha inflamáveis bem guardados. 	<ul style="list-style-type: none"> Use proteção para a vista, ouvido e corpo.
Japanese 注意事項	<ul style="list-style-type: none"> ● 通電中の電気部品、又は溶材にヒフやぬれた布で触れないこと。 ● 施工物やアースから身体が絶縁されている様にして下さい。 	<ul style="list-style-type: none"> ● 燃えやすいものの側での溶接作業は絶対にしてはなりません。 	<ul style="list-style-type: none"> ● 目、耳及び身体に保護具をして下さい。
Chinese 警告	<ul style="list-style-type: none"> ● 皮肤或湿衣物切勿接触带电部件及焊条。 ● 使你自已与地面和工作件绝缘。 	<ul style="list-style-type: none"> ● 把一切易燃物品移离工作场所。 	<ul style="list-style-type: none"> ● 佩戴眼、耳及身体劳动保护用具。
Korean 위험	<ul style="list-style-type: none"> ● 전도체나 용접봉을 젖은 형갑 또는 피부로 절대 접촉치 마십시오. ● 모재와 접지를 접촉치 마십시오. 	<ul style="list-style-type: none"> ● 인화성 물질을 접근시키지 마십시오. 	<ul style="list-style-type: none"> ● 눈, 귀와 몸에 보호장구를 착용하십시오.
Arabic تحذير	<ul style="list-style-type: none"> ● لا تلمس الاجزاء التي يسري فيها التيار الكهربائي أو الألكترود بجسد الجسم أو بالملابس المبللة بالماء. ● ضع عازلا على جسمك خلال العمل. 	<ul style="list-style-type: none"> ● ضع المواد القابلة للاشتعال في مكان بعيد. 	<ul style="list-style-type: none"> ● ضع أدوات وملابس واقية على عينيك وأذنيك وجسمك.

READ AND UNDERSTAND THE MANUFACTURER'S INSTRUCTION FOR THIS EQUIPMENT AND THE CONSUMABLES TO BE USED AND FOLLOW YOUR EMPLOYER'S SAFETY PRACTICES.

SE RECOMIENDA LEER Y ENTENDER LAS INSTRUCCIONES DEL FABRICANTE PARA EL USO DE ESTE EQUIPO Y LOS CONSUMIBLES QUE VA A UTILIZAR, SIGA LAS MEDIDAS DE SEGURIDAD DE SU SUPERVISOR.

LISEZ ET COMPRENEZ LES INSTRUCTIONS DU FABRICANT EN CE QUI REGARDE CET EQUIPMENT ET LES PRODUITS A ETRE EMPLOYES ET SUIVEZ LES PROCEDURES DE SECURITE DE VOTRE EMPLOYEUR.

LESEN SIE UND BEFOLGEN SIE DIE BETRIEBSANLEITUNG DER ANLAGE UND DEN ELEKTRODENEINSATZ DES HERSTELLERS. DIE UNFALLVERHÜTUNGSVORSCHRIFTEN DES ARBEITGEBERS SIND EBENFALLS ZU BEACHTEN.

			
<ul style="list-style-type: none"> Keep your head out of fumes. Use ventilation or exhaust to remove fumes from breathing zone. 	<ul style="list-style-type: none"> Turn power off before servicing. 	<ul style="list-style-type: none"> Do not operate with panel open or guards off. 	WARNING
<ul style="list-style-type: none"> Los humos fuera de la zona de respiración. Mantenga la cabeza fuera de los humos. Utilice ventilación o aspiración para gases. 	<ul style="list-style-type: none"> Desconectar el cable de alimentación de poder de la máquina antes de iniciar cualquier servicio. 	<ul style="list-style-type: none"> No operar con panel abierto o guardas quitadas. 	Spanish AVISO DE PRECAUCION
<ul style="list-style-type: none"> Gardez la tête à l'écart des fumées. Utilisez un ventilateur ou un aspirateur pour ôter les fumées des zones de travail. 	<ul style="list-style-type: none"> Débranchez le courant avant l'entretien. 	<ul style="list-style-type: none"> N'opérez pas avec les panneaux ouverts ou avec les dispositifs de protection enlevés. 	French ATTENTION
<ul style="list-style-type: none"> Vermeiden Sie das Einatmen von Schweißrauch! Sorgen Sie für gute Be- und Entlüftung des Arbeitsplatzes! 	<ul style="list-style-type: none"> Strom vor Wartungsarbeiten abschalten! (Netzstrom völlig öffnen; Maschine anhalten!) 	<ul style="list-style-type: none"> Anlage nie ohne Schutzgehäuse oder Innenschutzverkleidung in Betrieb setzen! 	German WARNUNG
<ul style="list-style-type: none"> Mantenha seu rosto da fumaça. Use ventilação e exaustão para remover fumo da zona respiratória. 	<ul style="list-style-type: none"> Não opere com as tampas removidas. Desligue a corrente antes de fazer serviço. Não toque as partes elétricas nuas. 	<ul style="list-style-type: none"> Mantenha-se afastado das partes moventes. Não opere com os painéis abertos ou guardas removidas. 	Portuguese ATENÇÃO
<ul style="list-style-type: none"> ● ヒュームから頭を離すようにして下さい。 ● 換気や排煙に十分留意して下さい。 	<ul style="list-style-type: none"> ● メンテナンス・サービスに取りかかる際には、まず電源スイッチを必ず切って下さい。 	<ul style="list-style-type: none"> ● パネルやカバーを取り外したまま機械操作をしないで下さい。 	Japanese 注意事項
<ul style="list-style-type: none"> ● 頭部遠離煙霧。 ● 在呼吸區使用通風或排風器除煙。 	<ul style="list-style-type: none"> ● 維修前切斷電源。 	<ul style="list-style-type: none"> ● 儀表板打開或沒有安全罩時不準作業。 	Chinese 警告
<ul style="list-style-type: none"> ● 얼굴로부터 용접가스를 멀리하십시오. ● 호흡지역으로부터 용접가스를 제거하기 위해 가스제거기나 통풍기를 사용하십시오. 	<ul style="list-style-type: none"> ● 보수전에 전원을 차단하십시오. 	<ul style="list-style-type: none"> ● 판넬이 열린 상태로 작동치 마십시오. 	Korean 위험
<ul style="list-style-type: none"> ● ابعد رأسك بعيداً عن الدخان. ● استعمل التهوية أو جهاز ضغط الدخان للخارج لكي تبعد الدخان عن المنطقة التي تتنفس فيها. 	<ul style="list-style-type: none"> ● أقطع التيار الكهربائي قبل القيام بأية صيانة. 	<ul style="list-style-type: none"> ● لا تشغيل هذا الجهاز اذا كانت الاغطية الحديدية الواقية ليست عليه. 	Arabic تحذير

LEIA E COMPREENDA AS INSTRUÇÕES DO FABRICANTE PARA ESTE EQUIPAMENTO E AS PARTES DE USO, E SIGA AS PRÁTICAS DE SEGURANÇA DO EMPREGADOR.

使う機械や溶材のメーカーの指示書をよく読み、まず理解して下さい。そして貴社の安全規定に従って下さい。

請詳細閱讀並理解製造廠提供的說明以及應該使用的銀焊材料，並請遵守貴方的有閣勞動保護規定。

이 제품에 동봉된 작업지침서를 숙지하시고 귀사의 작업자 안전수칙을 준수하시기 바랍니다.

اقرأ بتمعن وافهم تعليمات المصنع المنتج لهذه المعدات والمواد قبل استعمالها واتبع تعليمات الوقاية لصاحب العمل.



• World's Leader in Welding and Cutting Products •

• Sales and Service through Subsidiaries and Distributors Worldwide •

Cleveland, Ohio 44117-1199 U.S.A. TEL: 216.481.8100 FAX: 216.486.1751 WEB SITE: www.lincolnelectric.com