

TALKSWITCH USER GUIDE

TALKSWITCH TS-600 TELEPHONE

CT.TP005.005505

talkswitch®



ANSWERS WITH INTELLIGENCE®

TalkSwitch. Copyright 2006. All Rights Reserved.

Reproduction, adaptation or translation without prior written permission is prohibited, except as allowed under the copyright laws.

Information in this user guide is subject to change without notice and does not represent any commitment on the part of TalkSwitch. No part of this user guide may be reproduced or transmitted in any form or by any means, electronic or mechanical (including photocopying, recording, or information storage and retrieval systems) or translated to another language, for any purpose other than the licensee's personal use and as specifically allowed in the licensing agreement, without the express written permission of TalkSwitch.

Fifth Edition, May 2006.
CT.TP005.005505

TalkSwitch is a division of Centrepont Technologies Inc.

TABLE OF CONTENTS

Installing your phone	1
Introduction	1
Important safety instructions	1
Parts checklist	3
Installation	3
Connecting the handset	3
Connecting power through cord adapter	3
Connecting power directly from the AC adapter	4
Setting up your TS-600 phone	5
Configuring area codes	5
Configuring the outside line access code	6
Extensions with Direct Line Access	6
Selecting ring tone	6
Adjusting the display angle	6
Adjusting the display contrast	7
Adjusting the handset receiver volume	7
Adjusting the headset receiver volume	7
Adjusting speakerphone receiver volume	7
Using your phone	8
Overview of the TS-600 phone	8
The phone display	10
The menus and softkeys	10
Making a call	10
Redialing calls	11
Receiving a call	11
Hanging up a call	12
Putting a call on hold	12
Call waiting and queued calls	12
Transferring a call	12
Conferencing calls	13
Parking a call	13
Picking up a call	13
Overhead, intercom and group paging	14
Do not disturb	15
Ring once feature	15

Send a call to voicemail	15
Check voicemails	15
Accessing the call log	16
Viewing the Caller ID list	16
Calling back a number from the Caller ID list	16
Deleting a call from the Caller ID list	17
Using one-touch speed dials	17
Using the phone directory	17
Searching telephone numbers in the directory	17
Deleting entries in the directory	18
Programming a new phone number	18
Saving a caller's name and number	19
Maintenance information	20
Troubleshooting	20
Resetting your telephone's programming	20
Blank screen	21
Phone doesn't ring	21
No dial tone	21
No Caller ID	21
Handset doesn't work	22
Problems dialing	22
Message waiting count does not work	22
Can't receive on-hook intercom calls	22
Can't receive group paging	22
Limited warranty	23
FCC registration and repair information	25
Connection and use with the nationwide telephone network	25
Repair instructions	25
Interference information: Part 15 of FCC rules	26

Legend:



= softkey



= feature button



= numeric key

INSTALLING YOUR PHONE

INTRODUCTION

Congratulations on the purchase of your new TS-600 telephone.

This phone is specifically designed to take full advantage of the features of the TalkSwitch line of phone systems.

TS-600 Feature Overview

- Superior speakerphone
- Large hi-resolution screen
- Menu-driven user interface
- Combined power/telephone cord
- Headset support
- Data port
- Message waiting count
- Multiple ring tones
- Call timer
- 99 name telephone directory
- 99 entry Caller ID log
- Last 5 number redial list
- Intercom & group paging
- Ring once feature

Please take the time to familiarize yourself with this User Guide.

IMPORTANT SAFETY INSTRUCTIONS

When using telephone equipment, basic safety precautions should always be followed to reduce the risk of fire, electrical shock and injury, including the following:

1. Read and understand all instructions in this User Guide.
2. Follow all warnings and follow all instructions marked on the product.
3. Unplug this product from the wall outlet before cleaning. Do not use liquid or aerosol cleaners. Use a damp cloth for cleaning.
4. Telephones should not be used in a bathtub, shower or pool. Immersion of the telephone in water could cause an electrical shock.
5. Slots and openings in the cabinet back or bottom are provided for ventilation, to protect it from overheating. These openings must not be blocked or covered. This product should never be placed near or over a radiator, heat register or stove.
6. This product should be operated only with the power source provided.

7. Do not allow anything to rest on the telephone line cord or power cord. Do not locate this product where its cords will be stepped on or interfered with.
8. Do not overload outlets and extension cords, as this can result in the risk of fire or electric shock.
9. Never push objects of any kind into this product through the cabinet slots, as you may touch dangerous voltage points or short out parts that could result in fire or electrical shock.
10. Never spill liquid of any kind on the product.
11. To reduce the risk of electric shock, do not disassemble this product. Take it to a qualified service technician when service or repair work is required. Opening or removing covers may expose you to dangerous voltage or other risks. Incorrect reassembly can cause electrical shock when the product is subsequently used.
12. Never touch un-insulated telephone wires or terminals unless the telephone line has been disconnected at the network interface.
13. Never install or modify telephone wiring during a lightning storm.
14. Never install telephone jacks in wet locations unless the jack is specifically designed for wet locations.
15. Use caution when installing or modifying telephone lines.
16. Unplug the telephone from the wall outlet and refer servicing to qualified service personnel under the following conditions:
 - The power cord is frayed or damaged.
 - If liquid has been spilled into the telephone.
 - If the telephone has been exposed to rain or water.
 - If the telephone does not operate properly by following the operating instructions.
 - If the telephone has been dropped or the enclosure damaged.
 - If the telephone exhibits distinct changes in performance.
17. Avoid using a telephone during a thunderstorm. There may be a remote risk of electrical shock from lightning.
18. Do not use the telephone to report a gas leak in the vicinity of the leak.

PART CHECKLIST

The following parts are included with your TS-600 phone:

- TS-600 telephone
- Telephone base
- Telephone handset
- Line and handset cords
- Handset
- AC/DC adapter
- Cord adapter
- User Guide

INSTALLATION

Connecting the handset

Connect one end of the coiled handset cord to the handset jack on the left side of the phone and connect the other end of the coiled handset cord to the jack on the handset.

Connecting power through cord adapter

You can use the cord adapter to connect the AC adapter power to the telephone through the line cord.

1. Connect the AC adapter to an electrical wall outlet.
2. Connect the AC adapter plug to the DC jack of the cord adapter. The LED is lit to indicate DC power is available.

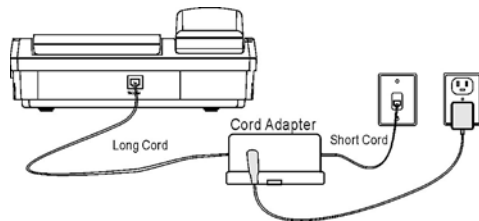

3. Connect one end of the short line cord to the wall jack and connect the other end of the short line cord to the TO LINE jack of the cord adapter.
4. Connect one end of the long line cord to the TO PHONE jack of the cord adapter and connect the other end to the TEL LINE jack of telephone.

Note: You must use the long cord provided with your phone.

Connecting power directly from the AC adapter

Alternatively, you can power this phone by directly connecting the AC power adapter to the phone.

1. Remove the rubber cap covering the DC12V plug behind the phone. It is located beside the TEL LINE jack.
2. Connect the AC adapter plug to the DC 12V jack of the telephone.
3. After installation, lift the telephone's handset and listen for the dial tone. If there is no dial tone, check to make sure all cords are firmly plugged into their jacks.

WALL MOUNTING

1. Turn the phone over so that you are looking at the bottom of the phone. Insert tabs at the narrow end of the wall-mount bracket into the holes at the rear of the phone bottom. Press and latch the tabs at the thicker end of the wall bracket into holes at the front end of phone. The bracket has two round plastic holes that can be used to hang your phone on the wallplate on your wall.

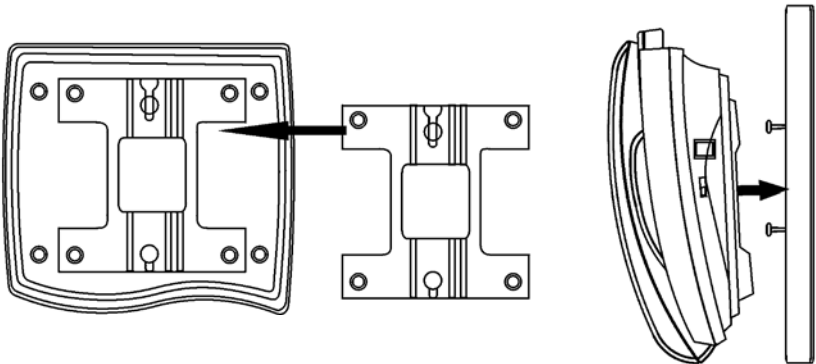

Note: If you do not wish to mount your phone on the wall, the Wall Mount Bracket can be reversed to raise the angle of the phone's display when sitting on a table or desk.

SETTING UP YOUR TS-600 PHONE

1. Press the **MENU** button to configure the phone. The menu screen will be displayed.
2. You can use the **▲** button or the **▼** button to move the selection indicator up or down, and press the **DIAL/ENTER** button to select an option. Alternatively, you can just press a digit to select the corresponding option.
3. If you made a mistake during telephone set up procedures, press the **GOODBYE** button. Set up procedure is terminated and the idle state screen will be displayed.

MENU	
Use ▲/▼	Enter To Select
1 =	Enter area codes
2 =	Enter access code
3 =	Select ring tone
4 =	Select flash duration

CONFIGURE AREA CODES

If you enter your local area codes, Caller ID number can be dialed correctly in North America. If you dial your local calls using 7 digits (e.g., 555-1212), you need to enter your area code for 7-digit dialing. Otherwise, enter up to 3 area codes for 10-digit local dialing. To enter area codes:

MENU	
Use ▲/▼	Enter To Select
1 =	7-digit dialing
2 =	10-digit dialing

1. Press the **MENU** button followed by **1**.
2. If you dial your local calls using 7 digits (e.g., 555-1212), then press **1** to enter your local area code.
3. If you dial your local calls using 10 digits (e.g., 303-555-1212), press **2** to enter up to 3 area codes for 10-digit dialing.
4. If you use this phone in an area where the caller's number can be dialed without modification, do not enter any area code. Caller's number will be dialed as it is received. If you enter an area code by mistake, use the **◀** button to delete an area code.
5. If you enter any area code, caller's number will be displayed with the North American format (613-725-2980). If you don't enter any area code, caller's number will be displayed as it is received (6137252980).

CONFIGURE THE OUTSIDE LINE ACCESS CODE

The outside line access code is dialed prior to any number over 6 digits stored in the directory, speed dial buttons, or the call log. A stored number with 6 or fewer digits is considered an internal number.

The outside line access code is not dialed for an internal call. A 3 second pause is inserted automatically between the outside line access code and the phone number.

Use Save to End
9

= DLA Mode Enable
Enter Access Code

Extensions with Direct Line Access

Direct Line Access allows you to access the outside phone lines directly, without having to enter a line access code. If your TalkSwitch extension is programmed for Direct Line Access, enter **#** as your line access code. This will ensure that features and dialing operate properly for your extension. Refer to your TalkSwitch programming guide for more information.

To enter outside line access code:

1. Press the **MENU** button followed by **2**.
2. Enter your outside line access code or **#** if your extension is configured for Direct Line Access.
3. Press the **SAVE** button to store the access code.

Selecting ring tone

You can select one of four ring tones for this telephone:

1. Press the **MENU** button followed by **3**.
2. The phone rings with Ring Tone 1 for about 2 seconds.
3. Press the **SAVE** button to select Ring Tone 1; or
4. Press the **▲** button or the **▼** button to select another ring tone.
5. After the end of the desired ring tone, press the **SAVE** button to select it.

Use Save to End

Use **▲/▼** Enter to Select

1 = Ring tone 1

2 = Ring tone 2

3 = Ring tone 3

4 = Ring tone 4

Adjusting the display angle

You can optimize the LCD display by adjusting the viewing angle. To adjust the LCD viewing angle, move the rear edge of the LCD module up or down.

ADJUSTING THE DISPLAY CONTRAST

The display can be adjusted to suit the light level of your room and your viewing preference. To make the contrast of the display lighter or darker, press the  button to the right of the screen until the desired contrast is reached.



ADJUSTING THE HANDSET RECEIVER VOLUME

If you need to adjust the handset receiver volume:

1. Lift the handset and listen to the dial tone.
2. Press the right side of the **VOLUME** button to increase the receiver volume.
3. Press the left side of the **VOLUME** button to decrease the receiver volume.
4. Replace the handset when the desired receiver volume is reached.

ADJUSTING THE HEADSET RECEIVER VOLUME

If you wish to use a headset with this telephone, we recommend a headset with a built-in amplifier for the microphone. An amplifier for adjusting headset receiver volume is built into this telephone. If you need to adjust the headset receiver volume:

1. Press the  headset button and listen to the dial tone.
2. Press the right side of the **VOLUME** button to increase the receiver volume.
3. Press the left side of the **VOLUME** button to decrease the receiver volume.
4. Press the  headset button or the **GOODBYE** button when the desired receiver volume is reached.

Note: The headset and handset volumes are tied together. Changing the headset volume will also change the handset volume.

ADJUSTING SPEAKERPHONE RECEIVER VOLUME

If you need to adjust the speakerphone receiver volume:

1. Press the **SPEAKER** button and listen to the dial tone.
2. Press the right side of the **VOLUME** button to increase the receiver volume.
3. Press the left side of the **VOLUME** button to decrease the receiver volume.
4. Press the **SPEAKER** button or the **GOODBYE** button when the desired receiver volume is reached.

USING YOUR PHONE

OVERVIEW OF THE TS-600 PHONE

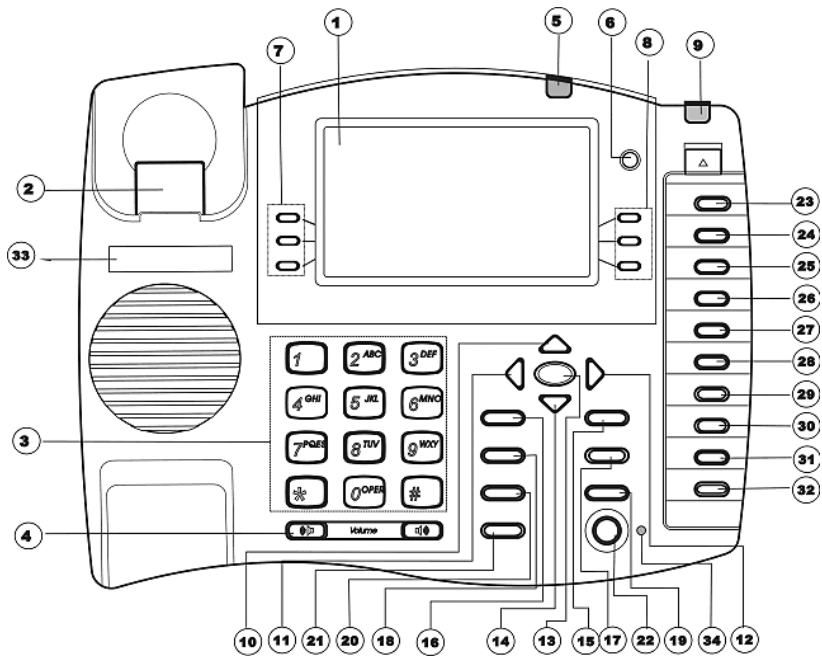

KEY LABEL	USAGE
1	DISPLAY • High-resolution display with 6 softkey labels.
2	HOOKSWITCH • On-hook and off-hook control for the handset.
3	KEYPAD • Used for dialing and programming.
4	VOLUME • Adjusts receiver volume for handset, speaker and headset. • Adjusts ringer volume.
5	MESSAGE LIGHT • Visual message waiting indicator.
6	● BUTTON • Adjust LCD contrast.
7,8	SOFTKEYS • Menu-driven keys for controlling phone calls.

KEY LABEL	USAGE
9 IN-USE LIGHT	<ul style="list-style-type: none"> • ON when phone is in use.
10 ▲	<ul style="list-style-type: none"> • View call log starting with the oldest call. • Scroll up when viewing a list.
11 ◀	<ul style="list-style-type: none"> • Move cursor left during programming.
12 ▶	<ul style="list-style-type: none"> • Move cursor right during programming.
13 DIAL/ENTER	<ul style="list-style-type: none"> • Dial displayed number. • Accept entry during programming.
14 ▼	<ul style="list-style-type: none"> • View call log starting with newest call. • Scroll down when viewing a list.
15 FLASH	<ul style="list-style-type: none"> • Send a flash on the line when on a call. • Include a flash in a programmed phone number or programmable key.
16 DIRECTORY	<ul style="list-style-type: none"> • Access the phone directory.
17 	<ul style="list-style-type: none"> • Activate the headset.
18 REDIAL	<ul style="list-style-type: none"> • Access the redial list.
19 MUTE	<ul style="list-style-type: none"> • Mute the microphone during a call. Light is on when enabled. • Enable/disable ring once feature when idle.
20 PAUSE	<ul style="list-style-type: none"> • Used to insert a pause when programming phone numbers.
21 GOODBYE	<ul style="list-style-type: none"> • Hang up a call at any time or exit programming.
22 SPEAKER	<ul style="list-style-type: none"> • Activate the speaker phone. Hang up when on a speakerphone call.
23 MENU	<ul style="list-style-type: none"> • Access the telephone configuration menu.
24 SAVE	<ul style="list-style-type: none"> • Start the programming of a directory entry or programmable button.
25 DELETE	<ul style="list-style-type: none"> • Delete a call record or directory entry.
26-32 BUTTONS	<ul style="list-style-type: none"> • Speed dial buttons can be programmed to quickly dial phone numbers or access TalkSwitch features.
33 INDEX	<ul style="list-style-type: none"> • Index card. Can be used to indicate the extension number.
34 SPEAKERPHONE INDICATOR	<ul style="list-style-type: none"> • On when the speakerphone is enabled.

THE PHONE DISPLAY

The phone's display is used to show call information as well as offer menu functions associated with the six softkeys on both sides of the display.

THE MENUS AND SOFTKEYS

Note: Using the **FLASH** button to access TalkSwitch features may cause the softkeys to be incorrect for the state of the call.

There are two main menus displayed on the phone. The first one is the Idle menu, when the phone is idle. The second one is the connected menu when the phone is connected to a call.

There are other sub-menus such as incoming call or feature sub-menus such as when a conference has been started.

When the phone is Idle, the display will show the following call menu:

12/09	03:00 PM
Pick Up	Do not Disturb
Un-park	Voicemail
Un-hold	Paging

When the phone is on an active call, the display will show the following call menu:

12/09	03:00 PM	00:05:21
613-725-2980		
John Smith		
Transfer	Trade Calls	
Park	Conference	
Hold	Send to VMail	

MAKING A CALL

Calls can be initiated in a number of different ways:

Traditional — Lift the handset and dial the number.

Handsfree or headset — Press the **SPEAKER** or  button and dial the number.

Call log — Dial from the call log. See the Call Log section for details on page 16.

Directory — Dial from the Phone Directory. See the Phone Directory section for details on page 17.

One-touch speed dial — Press the desired “One Touch” speed dial key to call a pre-programmed number.

Outside line access code is dialed automatically before any number with 7 or more digits stored in the call log, directory, or memory buttons.

If you use the telephone keypad to dial a number, please dial the outside line access code before the number.

You can switch a call between the handset, speakerphone or headset during the call by either lifting the handset, pressing the speaker or headset buttons.

REDIALING CALLS

1. When you press the **REDIAL** button, a list of previously dialed numbers is displayed. The most recently dialed number is displayed on the top of list.
2. Press the **▲** button and the **▼** button to move the highlighted line up and down, respectively. Press the **DIAL/ENTER** button when the desired number is highlighted.

RECEIVING CALLS

When receiving calls, your phone will ring and the display will show caller identity information if you are subscribed to Caller ID service.

To answer an incoming call,

Lift the handset, **or**

Press the **SPEAKER** button or **ANSWER** softkey, to answer the call in speaker phone mode, **or**

Press **📞** to answer the call in headset mode.

You can mute the ringing for the incoming call by pressing the **IGNORE** softkey.

Ringing volume can be adjusted or turned off by using the **VOLUME** button while the phone is idle or ringing.

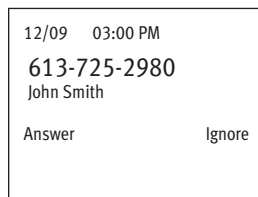

HANGING UP A CALL

1. You can hang up a phone call by pressing the **GOODBYE** button or putting the handset back in the cradle.

PUTTING A CALL ON HOLD

1. You can put a call on hold by pressing the **HOLD** softkey. Once a call is on hold, you can hang up your phone without losing the call.
2. In order to get re-connected to a call that you previously put on hold, you must first lift the handset or press the **SPEAKER** button, then press the **UNHOLD** softkey. You will be reconnected to your previous call.

Note: A call that was put on hold at a specific extension can only be retrieved from the same extension. In order to be able to re-connect to the call from a different extension, you would need to use the call **PARK** and **UNPARK** functions.

CALL WAITING AND QUEUED CALLS

When on a call, it is possible to receive another call if your extension is configured for call waiting as the chosen action in the busy call handling option of the TalkSwitch. It is also possible to automatically queue incoming calls to your extension or ring group.

If you receive a call waiting or queued call notification while on a call, you can answer the call waiting or queued call and put the current caller on hold by pressing the **TRADE CALLS** softkey. It is possible to switch between calls by repeatedly using the **TRADE CALLS** softkey.

TRANSFERRING A CALL

When you are on a call, you can transfer it to another extension or voice mailbox.

1. Press the **TRANSFER** softkey to put the current call on hold.
2. Dial the number of the extension you wish to send the call to and press the **OK** softkey.
3. Hang up the call or press **COMPLETE** softkey to complete the transfer. The person on hold will be connected to the number you just dialed.
4. If the number you dialed is busy or unavailable, you can press the **CANCEL TRANSF** softkey to get re-connected to your call on hold.

12/09	03:00 PM	00:05:21
Call Waiting:		
613-725-2980		
Jane Macdonald		
Transfer	Trade Calls	
Park	Conference	
Hold	Send to VMail	

CONFERENCING CALLS

When you are on a call, you can add another person to create a three-way call.

1. Press **CONFERENCE** softkey to put the current call on hold.
2. Dial the number of the extension or phone number of the person you would like to conference with and press the **OK** softkey. If you have *Direct Line Access* enabled at your extension, you will first need to dial **9** or another Hunt Group before dialing the second phone number.
3. Once the person has answered, press the **JOIN CALLS** softkey to add the call currently on hold to your conversation.
4. If the number you dialed is busy or unavailable, you can press the **CANCEL CONF** softkey to get re-connected to your call on hold.

PARKING A CALL

Parking a call puts the call on hold in one of ten park orbits, and allows you or someone else in your office to retrieve the call from any phone.

1. Press the **PARK** softkey to park the current call.
2. The system will respond by confirming the call is parked and will announce the park orbit. The orbit is between 500 and 509.

To retrieve a call that has been parked:

1. From any phone, lift the handset or press the **SPEAKER** button.
2. Press the **UNPARK** softkey, followed by the Park Orbit and the **OK** softkey. You will be connected to the call parked in the orbit specified.

PICKING UP A CALL

Call pick up allows you to answer a call ringing at someone else's extension.

When another extension is ringing:

1. Lift the handset or press the **SPEAKER** button.
2. Press the **PICKUP** softkey.
3. Select "Pick up any call" to pick up the extension that is ringing.
4. Select the "Pickup specific extension" to pick up a call at a the specified extension. You will be connected to the incoming call.

Note: Pick up works only for incoming external calls.

OVERHEAD, INTERCOM AND GROUP PAGING

The TS-600 menus support three types of paging: Overhead Paging, Intercom Paging and Group Paging.

Overhead Paging: Overhead paging allows you to connect to an overhead public address system. This function will work only if you have such a paging system installed.

1. Press the **PAGING** softkey.
2. Select the **OVERHEAD PAGING** softkey.

You are now connected to the overhead paging system and can proceed with your page.

Intercom Paging: On-hook intercom paging calls are automatically answered in speaker mode, enabling instant hands-free two-way communication. The telephone at the target extension must also support intercom.

1. Press the **PAGING** softkey.
2. Select the **INTERCOM** softkey.
3. Enter the extension you want to intercom with.
4. Press the **OK** softkey.

You will be connected to the extension specified.

Group Paging: Group paging calls are similar to on-hook intercom calls, but to a ring group and are only one-way audio for announcements. All the phones in the ring group are automatically answered in speaker mode to receive the page. The phones in the ring group must support group paging.

1. Press the **PAGING** softkey.
2. Select the **GROUP PAGING** softkey.
3. Enter the ring group number.
4. Press the **OK** softkey.

You are now connected to every telephone set in the ring group and can proceed with your page.

DO NOT DISTURB

You can enable Do Not Disturb on your extension and you will not receive any calls at that extension. All calls will follow the Do Not Disturb call cascade option for your extension, such as going directly to voicemail.

To enable/disable Do Not Disturb:

1. Lift the handset or press the **SPEAKER** /  button (optional).
2. Press the **DO NOT DISTURB** softkey.
3. Press the **ENABLE** / **DISABLE** softkey.
4. The Do Not Disturb setting of your extension will be changed. You will receive a system confirmation of Do Not Disturb "ON" or Do Not Disturb "OFF"

RING ONCE FEATURE

The TS-600 has a useful feature for minimizing ringing noise in an office environment. The phone can be set to ring only one time. Subsequent rings will be muted and the in-use light will flash during each ring.

To enable this feature, simply press the **MUTE** button while the phone is on-hook.

SEND A CALL TO VOICEMAIL

While on a call, you may wish to send the caller to a voicemail box in order for that caller to leave a message for someone else.

While on a call:

1. Press the **SEND TO VMAIL** softkey.
2. Enter the desired voicemail box number and press **OK** softkey
3. Hang up the call and the caller will now be able to leave a message.

CHECK VOICEMAILS

The TS-600 will indicate that you have new voice messages in your voice in-box by flashing the message waiting lamp.

The TS-600 will also display the number of new voice messages you have.

12/09 03:00 PM	
New Voice Message 03	
Pick Up	Do not Disturb
Un-park	Voicemail
Un-hold	Paging

This is shown on the display when the phone is idle.

To access your voicemail box:

1. Press the **VOICEMAIL** softkey.
2. Enter your password + **#**.

ACCESSING THE CALL LOG

When you receive a call, the phone number and name of the caller appears on the display with the day and time the call was received and is then stored in the Call Log.

Important Note: When a new call comes in, you must let your phone ring at least twice in order for the Caller ID information to be displayed.

Each call is assigned a call number. The most recent call has the highest number (e.g. #99) and the oldest call has the smallest number (e.g. #01).

09/28	06:43 PM
Call log #01	
480-948-4928	
SMITH JOHN	

VIEWING THE CALLER ID LIST

The TS-600 automatically stores the Caller ID information of the last 99 calls received in the call log. It keeps track of all calls received, whether they were answered or not. The oldest call in the call log is always call #1. The highest numbered call (or call #99 if the call log is full) is always the most recent call. If the Call log is full with 99 calls and a new call comes in, the oldest call, call #1, is automatically deleted to make room in the log for the new call.

Press the **▲** button or the **▼** button to review the Caller ID log from the oldest and the newest call, respectively.

CALLING BACK A NUMBER FROM THE CALL LOG

To easily call back a number from the Call log:

1. Press the **▲** button or the **▼** button until the number you want to call is displayed.
2. Press the **DIAL/ENTER** button. The number is dialed automatically.

Important Note: You need to have properly programmed your telephone with area code, outside line access code or mode (e.g. **9** or Direct Line Access) for this feature to properly work.

DELETING A CALL FROM THE CALL LOG

1. To delete a caller ID record in the log, press the **DELETE** button when the record is displayed. The record is permanently erased.
2. To delete all entries in call log, press and hold the **DELETE** button for 5 seconds when one of the caller ID records is displayed. All records are permanently erased.

USING ONE-TOUCH SPEED DIALS

The TS-600 has 7 programmable “One-touch” speed dial buttons. Pressing a speed dial key will automatically dial the programmed phone number.

Speed dial keys can be programmed by pressing **SAVE**. See the section on programming a new phone number for more details.

USING THE PHONE DIRECTORY

The directory makes dialing frequently used phone numbers quick and easy. You can enter the numbers and names by using the telephone keypad or by copying a caller’s name and number from the Caller ID call log into the directory.

SEARCHING TELEPHONE NUMBERS IN THE DIRECTORY

You can search for an entry in the directory when the phone is in use or idle.

1. Press **DIRECTORY** and one entry is displayed.
2. Press **▲** or **▼** until the record you want is displayed.
3. You can also press the appropriate keypad button one or more times to reach the first character of the name for which you are searching. For example, by pressing **5 5**, the first record with a name starting with “**K**” is displayed. Press **▼** and the next **K** listing is displayed.
4. To dial the number displayed, press **DIAL/ENTER**. The speakerphone is activated automatically before dialing.
5. To leave the directory mode at any time, press **GOODBYE**.

DELETING ENTRIES IN THE DIRECTORY

1. To delete an individual entry in the directory, press **DELETE** when the entry is displayed. The entry is permanently erased.
2. To delete all entries in directory, press and hold **DELETE** for 5 seconds when one of the directory entries is displayed. All entries are permanently erased.

PROGRAMMING A NEW PHONE NUMBER

To store a new number and name in the directory or for a speed dial key:

1. Press the **SAVE** button when the phone is idle.
2. Press the **DIRECTORY** button or any one of the programmable buttons.
3. Use the keypad to enter the telephone number, including the long-distance prefix that you need to dial this number. Insert a pause or multiple pauses where required by using the **PAUSE** button.
4. Press **SAVE** to save the number.

Note: Do NOT include the outside line access code in the phone number you entered.

5. Use the keypad to enter the name. The number and letters on each telephone button are displayed in turn. When the desired character is displayed, you can enter the next character. If you have to use the same button to enter the next character, press ► button to move the cursor to the next position and enter the next character. To insert a space, press ► button to move the cursor to the right.
6. After entering all characters, press **SAVE**.

While reviewing the call Log

- Pressing the **SAVE** softkey while viewing a call record will allow the user to automatically save the caller's name and number to the directory or a speed dial key.

SAVING A CALLER'S NAME AND NUMBER

You can easily save the name and number of a caller while reviewing your call log.

1. When the number and name you wish to store is displayed, press **SAVE**.
2. Press **DIRECTORY** or one of the memory buttons.
3. If you don't wish to change the name of caller, press **SAVE** again to save this entry.
4. If you wish to change the name of caller, press the ◀ button to move cursor to the first character you wish to modify and use the keypad to modify the name.
5. After entering all characters, press **SAVE** to save this number/name.

Note about programming phone numbers

- Do not program the outside line access code **9** as part of the number. The phone automatically inserts it for numbers that are 7 digits or more.
- You can include pauses in the dialing of the number by pressing the **PAUSE** button.
- You can include Flash in the dialing sequence by pressing the **FLASH** button.
- If your phone is configured for Direct Line Access, the phone will never insert a line access code **9**.
- These tips also apply to programming phone book entries.

MAINTENANCE INFORMATION

Although your unit is designed to be maintenance-free, it contains sensitive electronic parts. Treat it with care to assure the best performance.

Avoid Rough Treatment

Avoid dropping the unit. The original packaging should be used for protection if you must ship the unit. Dropping or damaging the unit will void the warranty.

Cleaning

The hard plastic casing on your unit has a durable finish. Clean exposed parts with a soft, slightly damp cloth. To remove stains, use a mild soap. Never use detergents, excess water, treated cloths, harsh cleaning agents, or sprays.

TROUBLESHOOTING

If you have any problems with your telephone, determine first if the problem is with your phone or with the phone line.

RESETTING YOUR TELEPHONE'S PROGRAMMING

Electrostatic shocks or power surges (e.g., from lightning) may cause the phone to lock up. There are two ways to reset the phone.

Basic Reset

1. Disconnect the power cord from the phone.
2. Wait for 10 seconds.
3. Reconnect the power cord to the phone.

Reset to Factory Defaults

If the basic reset cannot return the phone to the normal operating condition, you must restore to factory defaults. All information stored in memory will be erased.

1. Disconnect the power cord from the phone.
2. Wait for 10 seconds.
3. Press and hold **DELETE** and **▲** when reconnecting the power cord to the phone.
4. When firmware version number is displayed, release the buttons.

BLANK SCREEN

- Verify that your power adapter is properly connected.
- If you are using the power cord adapter, verify that it is properly connected and that you are using the long phone cord provided with your phone.

PHONE DOESN'T RING

- Verify that the ringer is not turned off. Press the **VOLUME UP** button while the phone is idle to turn the ringer on.
- Verify that the line cord is properly connected and that dial tone is present when going off-hook.
- Verify that the TalkSwitch is properly programmed for your extension's call handling.
- Verify that Do Not Disturb is disabled for your extension.

NO DIAL TONE

- Verify that the line cord is properly connected.
- Try with a different line cord.
- Test the telephone in a different jack. If it works, then the jack may be defective or the TalkSwitch may be wired incorrectly.

NO CALLER ID

- Check Caller ID subscription. In order to receive Caller ID for external calls, you must be subscribed to the Caller ID service from your telephone service provider.

HANDSET DOESN'T WORK

- Verify that the coiled handset cord jack is fully inserted into the handset.

PROBLEMS DIALING

- Ensure that your setting for outside line access code, for example **9** or **#** for direct line access, matches the setting on the TalkSwitch.

MESSAGE WAITING COUNT DOES NOT WORK

- Verify that your extension is programmed in TalkSwitch as a TS-600.

CAN'T RECEIVE ON-HOOK INTERCOM CALLS

- Verify that your extension is programmed in TalkSwitch as a TS-600.

CAN'T RECEIVE GROUP PAGING

- Verify that your extension is programmed in TalkSwitch as a TS-600.

LIMITED WARRANTY

TalkSwitch, a division of Centrepont Technologies Inc. (“TalkSwitch”) warrants to the original end-user customer (“Customer”) that each new TalkSwitch TS-600 telephone shall be substantially free from defects in materials and workmanship under normal use for a period of one (1) year from the date of the original purchase (proof of purchase required). The exclusive remedy and entire liability under this warranty will be for repair or replacement on a like-for-like basis at TalkSwitch’s option.

The above warranty shall not apply to product defects resulting from (a) improper maintenance or installation; (b) misuse, neglect or accident; (c) damage from moisture or corrosive environments; (d) use of the power adapter with supply voltages other than that for which it is specified; (e) static discharges; (f) high voltage surges; (g) electrostatic discharges; (h) operation outside the product’s specification; or (i) failure to follow product instructions.

The warranty is void where (a) the serial number has been altered, removed or effaced; or (b) the product has been used in an application, country, region, locality, or connected to any network, other than those for which the product was intended to operate.

TalkSwitch shall not have any obligation to repair or replace product until the Customer returns defective product to TalkSwitch. Any replacement product may be either new or like-new, and may contain remanufactured parts, equivalent to new in performance.

EXCEPT FOR THE EXPRESS WARRANTIES SET FORTH ABOVE, AND TO THE EXTENT PERMITTED BY APPLICABLE LAW, THE PRODUCTS IS SUPPLIED ON AN “AS IS” BASIS AND THERE ARE NO WARRANTIES, REPRESENTATIONS OR CONDITIONS WHETHER EXPRESSED OR IMPLIED, WRITTEN OR ORAL, ARISING BY STATUTE, OPERATION OF LAW, COURSE OF DEALING, USAGE OF TRADE OR OTHERWISE, WITH RESPECT TO THE PRODUCT. TALKSWITCH SPECIFICALLY DISCLAIMS ANY IMPLIED WARRANTIES OR CONDITIONS OF MERCHANTABILITY, SATISFACTORY QUALITY, DURABILITY, FITNESS FOR A PARTICULAR PURPOSE, AND NON-INFRINGEMENT.

In no event shall TalkSwitch be liable for any SPECIAL, INCIDENTAL, CONSEQUENTIAL, indirect OR SIMILAR damages, including any lost profits, lost data, or other incidental or consequential or punitive damages, whether based on contract, tort

(INCLUDING WITHOUT LIMITATION, NEGLIGENCE), or any other legal theory, whether or not advised of the possibility of such damages, or whether such damages are foreseeable. In any event, the total aggregate liability of TalkSwitch FOR DIRECT DAMAGES shall not exceed the purchase price of the product.

This warranty gives specific rights, and Customer may have other rights subject to jurisdiction. To the extent any part of this limited warranty statement is inconsistent with such local law, that part shall be deemed modified to be consistent with such local law.

FOR PRODUCTS PURCHASED IN THE U.S. OR CANADA

1. Contact your reseller and obtain a Warranty Return Authorization (WRA) number if required. If you bought the product directly from TalkSwitch, you can obtain this number by contacting the Technical Support department at TalkSwitch — call toll free in continental North America; (866) 393-9960, otherwise call (613) 725-2466. Please have your model and serial number available when you call.
2. Include a copy of your proof of purchase and a written explanation of the problem; this will enable us to expedite your repair.
3. Attach the shipping label to the exterior of the package.
4. On the shipping label, be sure to include the WRA number obtained from TalkSwitch or your reseller.
5. Ship the product (prepaid) to your reseller. If the product was purchased from TalkSwitch, send the unit in its *original or better protective packaging* to:

TalkSwitch
1545 Carling Ave., Suite 510
Ottawa, Ontario
K1Z 8P9
Canada

If the product is being shipped from outside of Canada, the following statement must be included on the package: **'Canadian Goods Being Returned to Canada'**.

Important: Failure to obtain a WRA number and include the information indicated above will result in the package being refused.

FCC REGISTRATION AND REPAIR INFORMATION

Your new product has been registered with the Federal Communication Commission (FCC). This product complies with standards in Part 68 of the FCC Rules. The FCC requires us to provide you with the following information:

Note: the TS-600 telephone is intended for use only behind a TalkSwitch PBX.

CONNECTION AND USE WITH THE NATIONWIDE TELEPHONE NETWORK

The modular telephone outlet or jack to which the telephone must be connected is a USOC RJ-11C or RJ-11W. The TS-600 telephone has a ringer equivalence number (REN) of 1.9B

REPAIR INSTRUCTIONS

If it is determined that your telephone equipment is malfunctioning, the FCC requires that it not be used and that it be unplugged from the modular outlet until the problem has been corrected. Repairs to the telephone equipment can only be made by the manufacturer or its authorized agents or by others who may be authorized by the FCC. For repair procedures, follow instruction outlined under the "Limited Warranty".

INTERFERENCE INFORMATION: PART 15 OF FCC RULES

Some telephone equipment generates, uses, and can radiate radio-frequency energy and, if not installed and used properly, may cause interference to radio and television reception.

Your product has been tested and found to meet the standards for a Class B digital device, as specified in Part 15 of the FCC Rules. Operation is subject to the following two conditions: (1) this device may not cause harmful interference, and (2) this device must accept any interference received, including interference that may cause undesired operation.

These specifications are designed to provide reasonable protection against such interference in a residential installation. However, there is no guarantee that interference will not occur in a particular installation.

If your product causes interference to radio or television reception when it is in use, you might correct the interference with any one or all of these measures: (a) where it can be done safely, reorient the receiving television or radio antenna. (b) To the extent possible, relocate the television, radio or other receiver with respect to the telephone equipment. (c) If your telephone product runs on AC power, plug your product into an AC outlet that is not on the same circuit as the one used by your radio or television.