

# Warm Mist Humidifier

Owner's Guide

English



Model  
**35216**

Form# 44059-01  
20100511  
©2010 Hunter Fan Co.

*SINCE 1886*  
**Hunter**<sup>®</sup>

# Table of Contents

## **At A Glance**

Warnings and Know Your Humidifier ..... 3

## **Using Your Humidifier**

Initial Setup and Operation..... 4

## **Maintenance**

Cleaning and Storage ..... 6

## **Humidifier Assistance**

Troubleshooting ..... 8

Support..... 9

## **Humidifier Accessories**

Treatments ..... 10

## **Warranty**

3 Year Guarantee ..... 11

**For the most effective and safe use of Hunter's Warm Mist humidifier, please READ AND SAVE THESE INSTRUCTIONS! Especially those regarding adding salt.**

- **ALWAYS** place this warm mist humidifier on a firm, level, and water resistant surface. ALWAYS place the warm mist humidifier at least six (6) inches away from walls and heat sources such as stoves, radiators, or heaters.
- **ALWAYS** place the warm mist humidifier in an area that is out of the reach of children especially infants or toddlers. Supervision is necessary when the warm mist unit is used near children, patients, or pets. Hunter realizes that many customers use warm mists humidifiers in their homes with small children. Please take the time to instruct children that the warm mist unit is not a toy. Warm mist humidifiers produce steam that could cause serious burns.
- Before using the warm mist humidifier, extend the cord and inspect for any signs of damage. **DO NOT** use the product if the cord has been damaged.
- This product has a polarized plug (one blade is wider than the other) as a safety feature. This plug will fit into a polarized outlet only one way. If the plug does not fit fully into the outlet, reverse the plug. If it still does not fit, contact a qualified electrician. **DO NOT** attempt to defeat or override this safety feature.
- **ALWAYS UNPLUG** the warm mist unit when it is not in operation or while it is being emptied, filled, or cleaned.
- The warm mist humidifier should always be placed at least four(4) feet from a bedside and out of reach of the patient or children.
- Always ensure the warm mist humidifier is sitting flat on the surface it is placed and not resting on the cord or other obstructions. Ensure the warm mist humidifier cord is tucked away as to prevent the warm mist form being upset or turned over.
- **DO NOT** add medication of any type into the water in the container. Do not cover the steam outlet or place anything over it while the warm mist humidifier is operating. Never drop or insert any object into any opening.
- Never fill the humidifier tank with hot water. Always use clean, cool tap water.

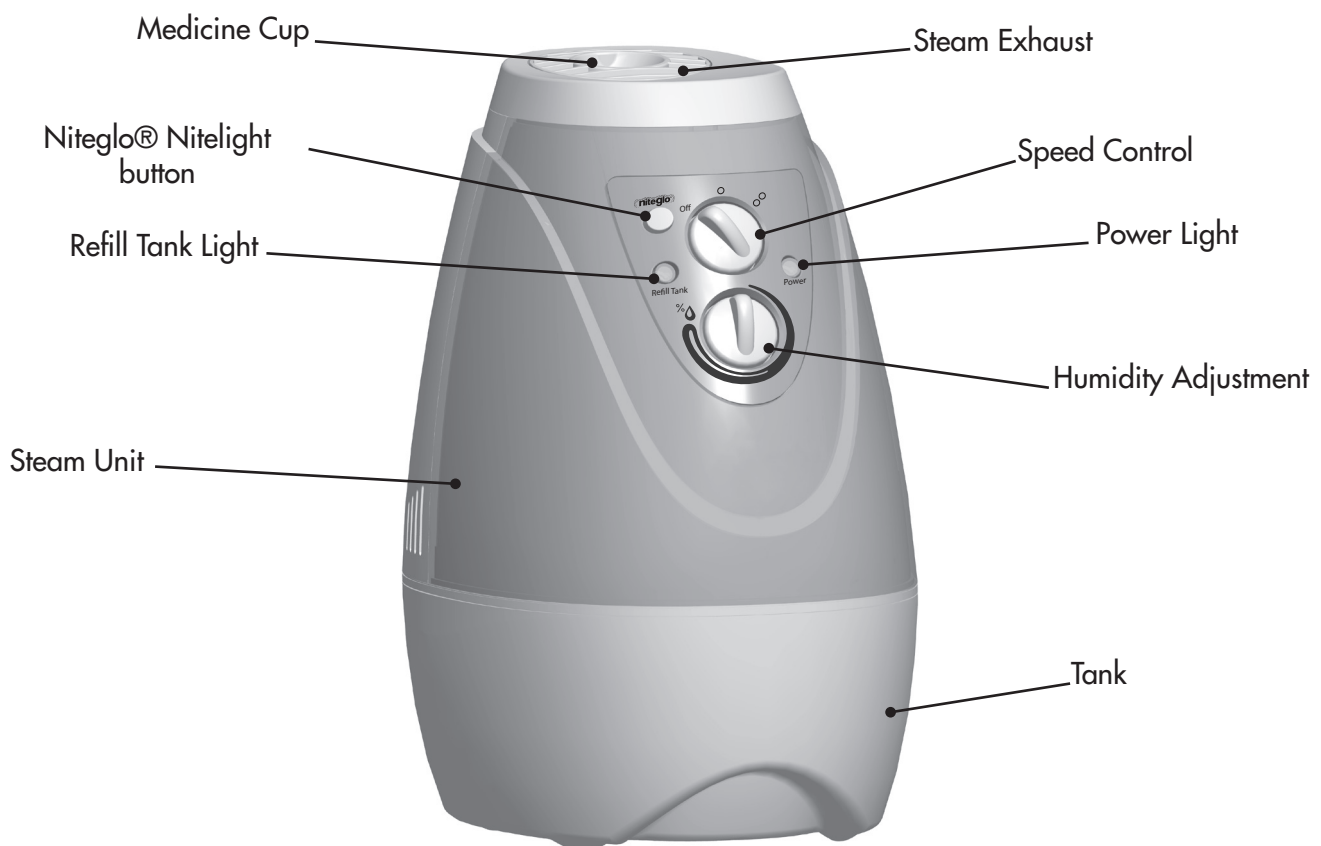

1. Remove the plastic bag covering from the warm mist humidifier.
2. Unravel and straighten the cord before use.
3. Remove the steam unit from the tank. Hold the steam unit securely and press the release button just above the power cord on the back of the steam unit and pull straight up and off. Figure 1.
4. Fill the tank with clean, cool tap water until the water level is about an inch from the top of the tank. **DO NOT OVERFILL.**
5. Replace the steam unit in the tank and gently press down until the tabs on the tank snap into place on the steam unit. Figure 2.
6. When using warm mist medications, fill the medicine cup on the steam unit as directed by the medicine package.

**NOTE: DO NOT** add medication of any type into the water in the tank.

7. Plug the power cord into 110-120 Volts AC outlet protected up to 15 Amps. The warm mist will produce a gentle flow of steam within a few minutes.

**CAUTION: DO NOT** use the warm mist with extension cords.

**NOTE:** Protect your floor and furniture by placing the warm mist unit on a non-metallic, waterproof, heat-resistant surface.

8. If steaming does not start within ten minutes, unplug the steam unit and allow to cool.
9. Remove the steam unit from the tank and add 2 to 3 pinches of ordinary table salt to the water and mix thoroughly.
10. Reassemble the unit.
11. If steaming still does not start after another 10 minutes, add another pinch or two of salt and mix thoroughly. Do not exceed 1/8 teaspoon of salt, about 4-5 pinches, as excessive boiling or a blown fuse could occur.

**Note:** Remember the amount of salt you added to start the unit steaming. You will need to add the same amount each time the unit is refilled. Salt has no effect on the purity of the steam or medication.

12. The warm mist will automatically stop producing steam when the water has reached the minimum water level. The refill light will come on to indicate the unit is out of water. Turn the unit off and refill according to the directions above.

**Caution: ALWAYS** unplug the steam unit and allow to cool before removing the tank. Never remove the steam unit before it has cooled as you could be burned or shocked.

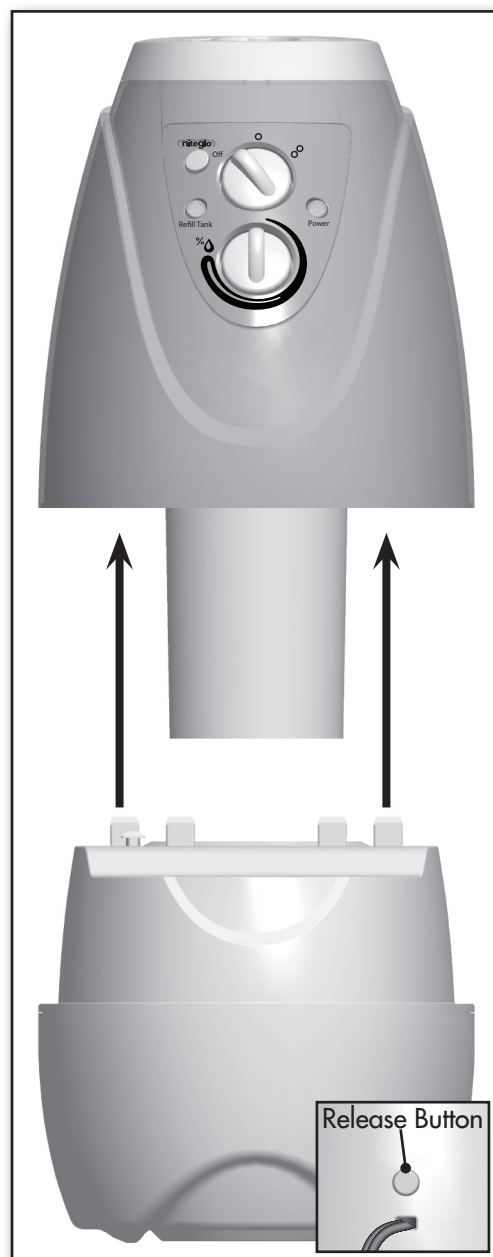

**Figure 1.**

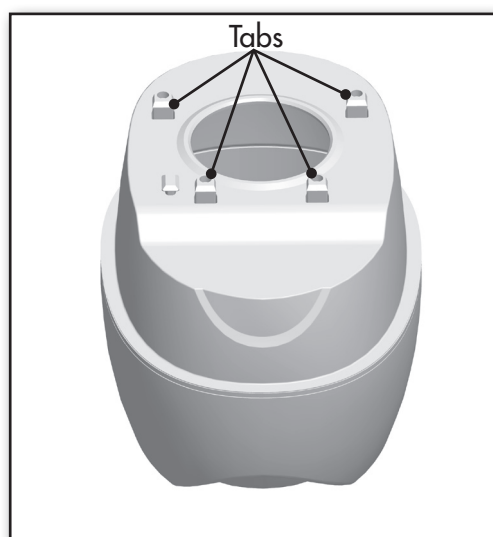

**Figure 2.**

**Speed Control:**

- OFF** Unit off
- Low: Lowest Noise setting recommended for nighttime use. Extends the time between refills by running the fan on low.
- High: Average refill rate and optimal for day use. Moderate noise level.

**niteglo™ nitelight:**

Turns on or off the humidifier's nitelight.

 **Humidity Adjustment Knob:**

Adjusts the humidity levels between 30% and 80% humidity output.

**Refill Tank Light:**

Comes on when the water in tank has reached minimum level. The light will turn off as soon as the tank has been refilled.

**Power Light:**

Indicates the unit is on and should be running. If it is not, check the water level, or humidity setting. For further help see "Troubleshooting" on page 8.

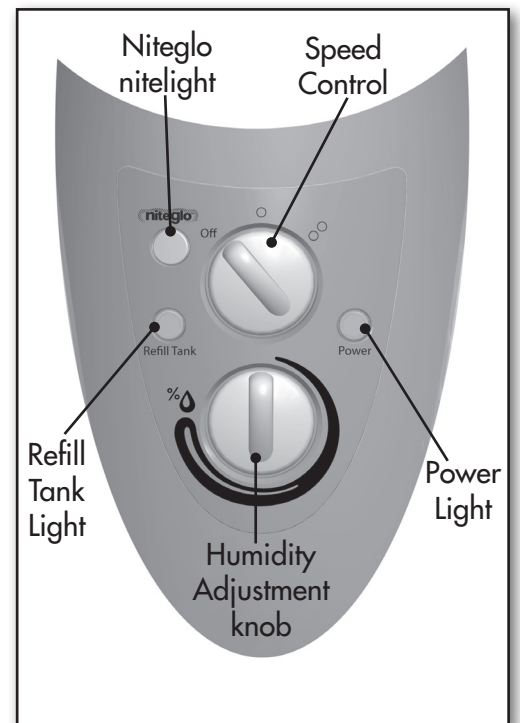

**Figure 3.**

**Note: ALWAYS** unplug the steam unit from the electrical outlet and allow the unit to cool before cleaning. Never remove the steam unit while it is plugged in, electrocution or burning could occur. **DO NOT** attempt to disassemble the steam unit. **NEVER** allow water to sit in the tank when not in use.

#### Daily Maintenance:

1. Unplug the steam unit and allow it to cool.
2. Remove the steam unit by pressing the release button on the back above the power cord and pulling it straight off the tank.
3. Let all water drain back into the tank from the steam unit.
4. Turn the tank upside down and drain any water into a sink or tub. Shake the unit gently to remove any remaining water.
5. Rinse the tank thoroughly with water, empty, and wipe with a dry, clean cloth. Figure 3.
6. Wipe the steam unit shaft with a dry cloth. Figure 4.
7. If the medicine cup was used, wipe it out with a slightly damp, clean cloth. Figure 5.
8. Refill the tank as directed under "initial setup and operation" and resume use.



**Figure 3.**

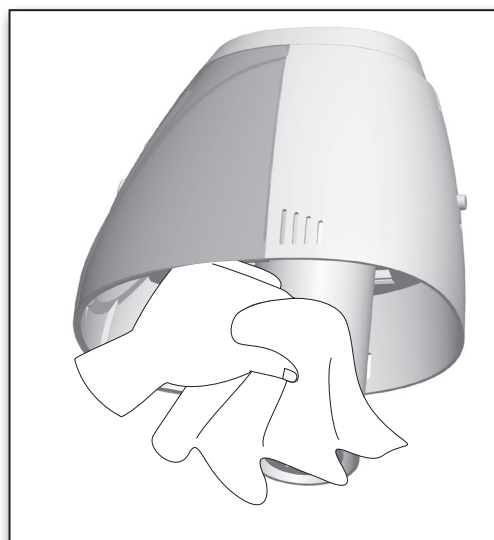

**Figure 4.**

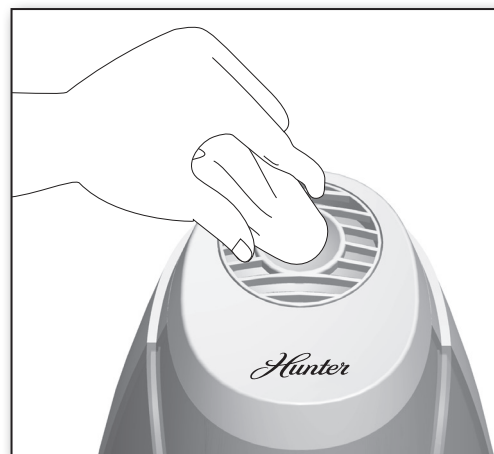

**Figure 5.**

#### Weekly Maintenance:

1. Unplug the steam unit and allow it to cool.
2. Remove the steam unit by pressing the release button on the back above the power cord and pulling it straight off the tank.
3. Let all water drain back into the tank from the steam unit.
4. Turn the tank upside down and drain any water into a sink or tub. Shake the unit gently to remove any remaining water.
5. Create a 50/50 solution of vinegar and water which should be 1/2 gallon vinegar and 1/2 gallon water. Pour this solution into the tank. Be sure to only fill the tank to about 1 inch from the top of the tank. With the steam unit unplugged, place it back into the tank and soak for 30 minutes. After soaking for 30 minutes, remove the steam unit.
6. Empty the solution from the tank and rinse the tank. Fill the tank with tap water. Place the steam unit back into the tank for 30 seconds. Remove the steam unit and empty the water. Repeat the rinsing steps until the vinegar smell is gone.
7. Dry with a clean cloth. Clean the medicine cup with a slightly damp clean cloth.

**Note:** The tank has built-in antimicrobial properties to inhibit the growth of bacteria, mold, and fungi that may affect the water in the tank. Daily and weekly maintenance is still necessary to prevent the growth of bacteria, mold, and fungi.

**End of Season Maintenance:**

1. Follow the instructions for weekly maintenance before storing the unit.
2. Ensure all parts are completely dry before storing the unit.
3. Store the unit in a cool dry place.
4. Never store the unit with water in the tank.

**A. Warm mist humidifier does not operate or steams too slowly:**

1. Make sure the warm mist is plugged in and the power light is on.
2. If the power light is not on, you may have a blown fuse, tripped a circuit breaker, or a defective electrical outlet. Try a different outlet or check your breaker or fuse in the house.
3. The fault may be low mineral content in the water. To rectify:
  - I. Unplug the warm mist from the electrical outlet and allow to cool.
  - II. Remove the steam unit allowing hot water to first dribble out, then add one or two pinches of salt to the water and mix thoroughly.
  - III. Replace the steam unit and plug in the warm mist. It should steam within 5 minutes. If it does not, add salt only by the pinch, since too much salt can cause excessive boiling or a blown fuse.
4. If the warm mist has been operating normally and is now failing to steam, it may need to be cleaned. See the weekly maintenance section under "Cleaning and Storage" on page 6.

**B. Warm mist operates too fast, fuse blows:**

Overboiling, flickering lights, blown fuse, or heavy steam flow generally indicates one of the following causes:

1. Too much salt was added to the water. To correct the condition:
  - I. Disconnect the warm mist from the electrical outlet and allow to cool.
  - II. Pour out the water and rinse the tank. Rinse steam unit as described in weekly maintenance under "Cleaning and Storage" on page 6. Refill with fresh water but do not add salt. If warm mist now does not operate or steams too slowly, follow the instructions in "Initial Setup and Operation" on page 4.
2. You live in a "hard water" area and minerals in the tap water are causing the warm mist to steam too rapidly. To correct the condition:
  - I. Disconnect the warm mist from the electrical outlet and allow to cool.
  - II. Remove steam unit allowing hot water to first dribble out, then pour out water and rinse the tank. Rinse steam unit as described in the weekly maintenance section. Refill with fresh water but do not add salt.
  - III. If unit still steams too rapidly, use 1/2 distilled water and 1/2 tap water.
  - IV. In "hard water" areas it is advisable to clean the unit every few days in accordance with the weekly maintenance instructions.

**C. Warm mist is making crackling / buzzing / humming sounds or water container is unusually hot:**

1. You may have added too much salt. See section B above.
2. You may live in a "hard water" area. See section B above.
3. This condition can happen when the water level in the tank is low. Disconnect the warm mist from the electrical outlet, allow to cool, remove steam unit allowing hot water to first dribble out. Fill the tank with tap water to MAX water level marking.
4. This may be an indication your warm mist needs cleaning. Refer to weekly maintenance under "Cleaning and Storage" on page 6.



### Technical Support

If you need any assistance with setup, operation, or parts for your new Hunter Humidifier, please call us, our technical support staff is ready to help!

**USA: 1-888-830-1326**  
**Canada: 1-866-268-1936**





Hours of operation are from 7:00 am to 7:00 pm Monday - Friday and 8:00 am to 5:00 pm on Saturday, Central Time. You may also contact us over the Internet at [www.hunterfan.com](http://www.hunterfan.com) or register your product at [www.hunterfan.com/register](http://www.hunterfan.com/register) and select your product under product registration.

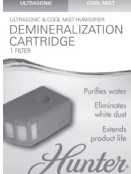

# Humidifier Accessories

5

## Treatments

	Model	Product	Evaporative	Ultrasonic	Vaporizer	Warm Mist
 <p>ULTRASONIC COOL MIST  <b>CLEANING CARTRIDGE</b>                  FILTER  <b>PREVENT</b>                  Microban                  Keeps your humidifier cleaner, longer. Cartridges clean &amp; protect humidifier against bacteria &amp; mold. Simply drop in and let fresh, clean mist keep clearing for 30 days.  <i>Hunter</i></p>	31955	Cleaning Cartridge	✓	✓		
 <p>ULTRASONIC COOL MIST  <b>DEMINERALIZATION CARTRIDGE</b>                  FILTER                  Purifies water. Eliminates white dust. Extends product life.  <i>Hunter</i></p>	31954	Demineralization Cartridge	✓	✓		
 <p>ULTRASONIC COOL MIST  <b>VAPOR STEAM</b>                  COOL MIST CARTRIDGE                  Liquid medication for Hunter's hot steam warm mist &amp; vaporizers. Maintains steam effect to relieve coughs from colds.  <i>Hunter</i></p>	31961	Vapor Steam			✓	✓
 <p>ULTRASONIC COOL MIST  <b>VAPOR PADS</b>                  2 REFILL SCENT PADS                  Soothing menthol vapors. Up to 8 hours of comfort per pad.  <i>Hunter</i></p>	31956	Vapor Pads	✓	✓		
 <p>ULTRASONIC COOL MIST  <b>WATER TREATMENT</b>                  TABLETS                  Controls sedimentation. Removes mineral buildup. Eliminates white dust. Protects the life of your humidifier.  <i>Hunter</i></p>	31960	Water Treatment Tablets	✓	✓		

The Hunter Fan Company, Inc. makes the following warranty to the original residential user or consumer purchaser of The Care Free® Warm mist Plus: If any part of the Warm mist fails during the first 3 (three) years from the date of purchase due to a defect in material or workmanship, we will provide a replacement part free of charge.

If no replacement part can be provided, we will replace your Warm mist.

IF THE ORIGINAL RESIDENTIAL USER OR CONSUMER PURCHASER CEASES TO OWN THE Warm mist, THIS WARRANTY AND ANY IMPLIED WARRANTY WHICH THEN REMAINS IN EFFECT, INCLUDING BUT NOT LIMITED TO ANY IMPLIED WARRANTY OF MERCHANTABILITY OR FITNESS FOR A PARTICULAR PURPOSE, ARE VOIDED. THIS WARRANTY IS IN LIEU OF ALL OTHER EXPRESS WARRANTIES. THE DURATION OF ANY IMPLIED WARRANTY, INCLUDING BUT NOT LIMITED TO ANY IMPLIED WARRANTY OF MERCHANTABILITY OR FITNESS FOR A PARTICULAR PURPOSE IS EXPRESSLY LIMITED TO THE PERIOD OF THE EXPRESS WARRANTY SET FORTH ABOVE.

This warranty is voided if your warm mist is not purchased and used in the USA or Canada.

This warranty excludes and does not cover defects, malfunctions, or failures of the Warm mist which were caused by repairs by persons not authorized by us, use of parts, or accessories not authorized by us, mishandling, modifications, or damage to the Warm mist while in your possession, or unreasonable use, including failure to provide reasonable and necessary maintenance. This warranty does not cover Warm mists used in commercial applications. There are no express or implied warranties as to commercial purchasers or users.

To obtain service, contact the nearest Hunter authorized service center or the Hunter Fan Company Service Department, 7130 Goodlett Farms Pkwy., Suite 400, Memphis, TN 38016, 1-888-830-1326. You will be responsible for insurance and freight or other transportation to our factory service center. We will return the Warm mist freight prepaid to you. The Warm mist should be properly packaged to avoid damage in transit since we will not be responsible for any such damage. Proof of purchase is required when requesting warranty service. The purchaser must present the sales receipt or other document that establishes proof of purchase.

IN NO EVENT SHALL HUNTER FAN COMPANY BE LIABLE FOR DIRECT, INDIRECT, SPECIAL, CONSEQUENTIAL OR INCIDENTAL DAMAGES IN EXCESS OF THE PURCHASE PRICE OF THE Warm mist. YOUR SOLE REMEDY WILL BE REPAIR OR REPLACEMENT AS PROVIDED ABOVE. SOME AMERICAN STATES AND CANADIAN PROVINCES DO NOT ALLOW:

- LIMITATIONS ON HOW LONG AN IMPLIED WARRANTY LASTS;
- THE EXCLUSION OR LIMITATION OF DIRECT, INDIRECT, SPECIAL, INCIDENTAL OR CONSEQUENTIAL DAMAGES;
- THE EXCLUSION OR INVALIDITY OF EXPRESS OR IMPLIED WARRANTIES IF THE USER CEASES TO OWN THE Warm mist;
- THE LIMITATION OF THE REMEDIES AND RECOURSES AVAILABLE TO THE PURCHASER; OR THE INVALIDITY OF AN EXPRESS WARRANTY WHEN A PRODUCT IDENTIFIED BY BRAND NAME IS NOT USED (UNLESS SPECIFIC CONDITIONS ARE FULFILLED);

SO THE ABOVE LIMITATIONS OR EXCLUSIONS MAY NOT APPLY TO YOU.

THIS WARRANTY GIVES YOU SPECIFIC LEGAL RIGHTS AND YOU MAY ALSO HAVE OTHER RIGHTS WHICH VARY FROM STATE TO STATE OR PROVINCE TO PROVINCE.



