



Installation, Start-Up and Service Instructions

CONTENTS

	Page
SAFETY CONSIDERATIONS	1
INSTALLATION	1-10
Step 1 — Complete Pre-Installation Checks	1
• UNPACK UNIT	
• INSPECT SHIPMENT	
• CONSIDER SYSTEM REQUIREMENTS	
• MATCHING THE CONDENSING UNIT TO AN INDOOR UNIT	
Step 2 — Rig and Mount Unit	3
• MOUNTING ON GROUND	
• MOUNTING ON ROOF	
• RIGGING	
Step 3 — Complete Refrigerant Piping Connections	3
• CHECK ACCURATER CONTROL	
• FILTER DRIER	
• MAKE PIPING SWEAT CONNECTORS	
• PROVIDE SAFETY RELIEF	
Step 4 — Make Electrical Connections	6
• CONTROL CIRCUIT WIRING	
• POWER WIRING	
• CONNECTIONS TO DUCT-FREE FAN COIL UNITS	
START-UP	11
SERVICE	11-14
MAINTENANCE	14
TROUBLESHOOTING	14,15

SAFETY CONSIDERATIONS

Installing and servicing air conditioning equipment can be hazardous due to system pressure and electrical components. Only trained and qualified service personnel should install or service air conditioning equipment.

Untrained personnel can perform basic maintenance, such as cleaning and replacing filters. All other operations should be performed by trained service personnel. When working on air conditioning equipment, observe safety precautions in literature, tags, and labels attached to unit.

Follow all safety codes. Wear safety glasses and work gloves. Use quenching cloth for brazing operations. Have fire extinguisher available. Read these instructions *thoroughly*. Consult local building codes and the National Electrical Code (NEC) for special installation requirements.

⚠ WARNING

Before installing or servicing system, always turn off main power to system. There may be more than one disconnect switch. Turn off accessory heater power if applicable. Electrical shock can cause serious personal injury.

⚠ CAUTION

Puron® (R-410A) refrigerant systems operate at higher pressures than standard R-22 systems. Do not use R-22 service equipment or components on Puron refrigerant equipment. If service equipment is not rated for Puron refrigerant, equipment damage or personal injury may result.

INSTALLATION

Step 1 — Complete Pre-Installation Checks

UNPACK UNIT (See Fig. 1) — Move the unit to final location. Remove unit from carton, being careful not to damage service valves and grilles.

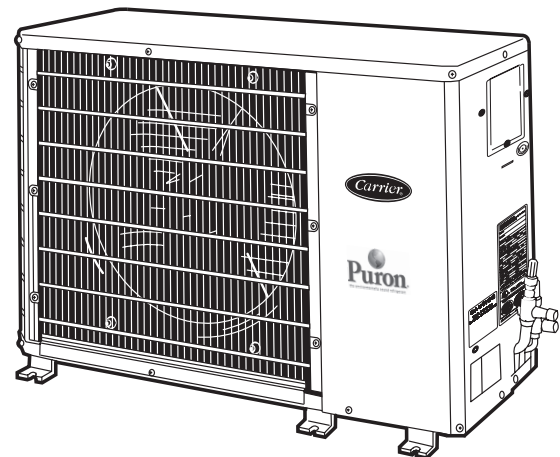

Fig. 1 — 38HDF,HDR Unit

INSPECT SHIPMENT — File a claim with the shipping company if shipment is damaged or incomplete. Check unit nameplate to ensure unit matches job requirements.

CONSIDER SYSTEM REQUIREMENTS — Consult local building codes and NEC for special installation requirements.

Allow sufficient space for airflow clearance, wiring, refrigerant piping, and servicing unit. See Fig. 2.

Locate unit so that condenser airflow is unrestricted on both sides. Refer to Fig. 2.

Unit may be mounted on a level pad directly on base legs or mounted on raised pads at support points. See Fig. 2 for center of gravity.

MATCHING THE CONDENSING UNIT TO AN INDOOR UNIT — The 38HDF,HDR units can be matched to a corresponding indoor unit. The 38HDF018-036 units can be matched with an in-ceiling cassette or high wall indoor unit. The 38HDR unit can be matched with under-ceiling and residential fan coils. Refer to separate indoor unit literature for more information.

UNIT MODELS		CHASSIS SIZE (Reference)	DIMENSIONS (inches)												
38HDF Unit Size	38HDR Unit Size		A	B	C	D	E	F	G	H	J	K	L	N	P
018	018	0	2'-11 1/8" (638.2)	3'-0 15/16" (938.2)	1'-29 1/16" (369.9)	1'-4" (406.4)	1'-11 7/16" (595.3)	1'-59 1/16" (436.6)	1'-10" (559.1)	1'-1" (330.2)	0'-6 3/8" (166.3)	0'-11 1/2" (285.8)	0'-2 15/16" (75)	0'-6" (152.4)	
024, 030	024	0.6	2'-7 7/8" (790.6)	3'-0 5/16" (938.2)	1'-29 1/16" (369.9)	1'-4" (406.4)	1'-11 7/16" (595.3)	1'-59 1/16" (436.6)	2'-4" (711.5)	1'-2" (355.6)	0'-6 3/4" (171.5)	0'-11 5/8" (285.3)	0'-2 5/16" (75)	0'-6" (152.4)	
036	030, 036	1.0	3'-1 13/16" (944.6)	3'-89 1/16" (1131.9)	1'-5 1/16" (433.4)	1'-6 7/16" (468.3)	2'-6 1/2" (774.7)	2'-59 1/16" (741)	2'-10 1/16" (865.5)	1'-1 11/16" (347.7)	1'-3 7/8" (206.4)	0'-3 7/8" (403.2)	0'-3 7/16" (88)	0'-6 1/2" (165.4)	
048, 060	048, 060	1.6	3'-7 3/8" (1097)	3'-89 1/16" (1131.9)	1'-5 1/16" (433.4)	1'-6 7/16" (468.3)	2'-6 1/2" (774.7)	2'-19 1/16" (893.4)	3'-4 1/2" (1017.9)	1'-2 1/2" (354.2)	0'-8 1/2" (215.9)	1'-6 7/8" (479.4)	0'-3 7/16" (88)	0'-6 1/2" (165.4)	

NOTE: Dimensions shown in feet-inches. Dimensions in () are millimeters.

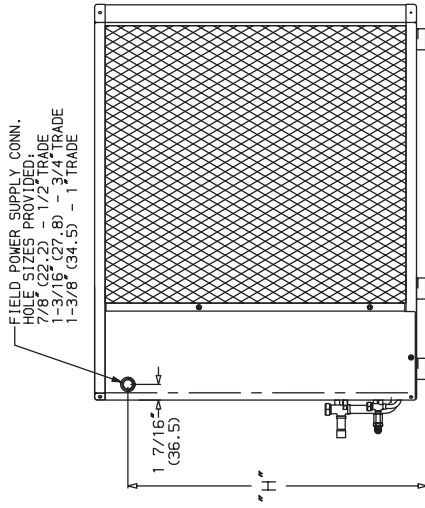
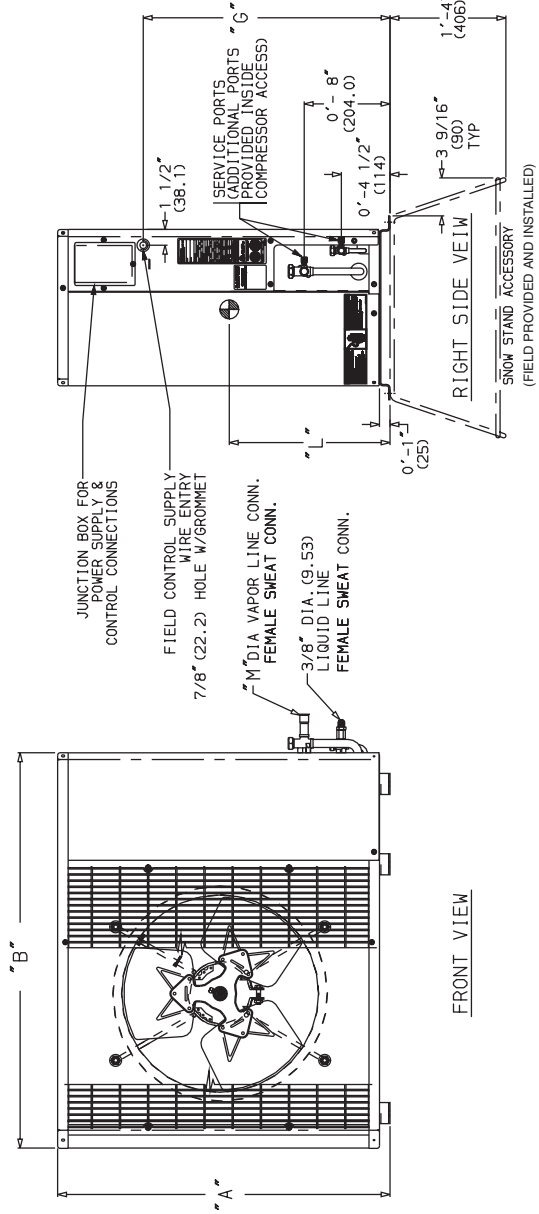
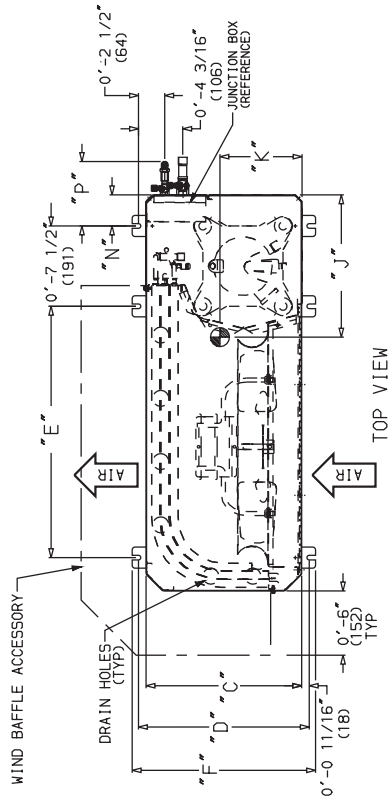

UNIT SIZE	M		OPERATING WT		
	in.	mm	lb	kg	
38HDF	018	5/8	15.88	166	75.3
	024	5/8	15.88	176	79.8
	030	3/4	19.05	187	84.8
38HDR	036	3/4	19.05	250	113.4
	018	5/8	15.88	166	75.8
	024	5/8	15.88	176	79.8
	030	3/4	19.05	187	84.8
	048	7/8	22.22	278	126.1
	060	7/8	22.22	306	138.8

UNIT SIZE	MINIMUM MOUNTING PAD DIMENSIONS	
	Support Feet	
CHASSIS SIZES 0 & 6	ft-in.	mm
	1'-11" x 3'-6"	584.2 x 1066.8
CHASSIS SIZES 1 & 1.6	2'-0" x 4'-2"	609.6 x 1270

- NOTES:
- Required clearances: with coil facing wall, allow 6 in. minimum clearance on coil side and coil end, and 3 feet minimum clearance on compressor end and fan side. With fan facing wall, allow 8 in. minimum clearance on fan side and coil end, and 3 feet minimum clearance on compressor end and coil side. With multi-unit application, arrange units so discharge of one does not enter inlet of another.
 - Dimensions in parenthesis are in millimeters.
 - Center of Gravity

Fig. 2 — 38HDF, HDR Unit Dimensions

Step 2 — Rig and Mount Unit

MOUNTING ON GROUND — Mount unit on a solid, level concrete pad. Position unit so water or ice from roof does not fall directly onto unit. Accessory stacking kits can be used when units are to be stacked. See installation instructions provided with the accessory kit. Use field-provided snow stand or ice rack where prolonged subfreezing temperatures or heavy snow occurs.

If conditions or local codes require unit be fastened to a pad, 6 field-supplied tiedown bolts should be used and fastened through slots provided in unit mounting feet.

MOUNTING ON ROOF — Mount unit on a level platform or frame at least 6 in. above roof surface. Isolate unit and tubing from structure.

RIGGING

⚠ CAUTION

Be sure unit panels are securely in place prior to rigging. Loose unit panels could result in equipment damage or personal injury.

Keep the unit upright and lift unit using a sling. Use cardboard or padding under the sling, and spreader bars to prevent sling damage to the unit. See Fig. 3. See Fig. 2 for center of gravity reference. Install the unit so that the coil does not face into prevailing winds. If this is not possible and constant winds above 25 mph are expected, use accessory wind baffle. See installation instructions provided with the accessory kit.

NOTE: Accessory wind baffles should be used on all units with accessory low ambient temperature control.

Field-fabricated snow or ice stands may be used to raise unit when operation will be required during winter months. Units may also be wall mounted using the accessory wall-mounting kit.

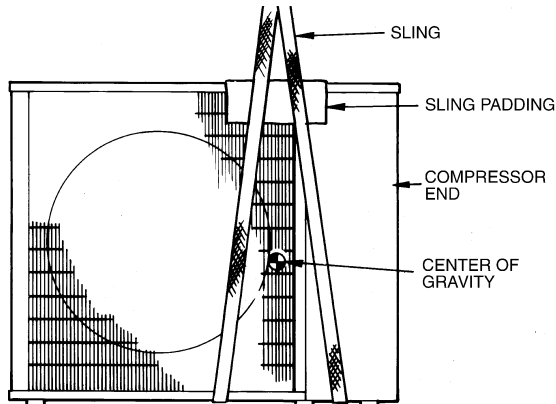

Fig. 3 — Lifting Unit with Sling

Step 3 — Complete Refrigerant Piping Connections

Outdoor units may be connected to indoor units using field-supplied tubing of refrigerant grade and condition. See Tables 1A and 1B for correct line sizes. Do not use less than 10 ft of interconnecting tubing.

⚠ CAUTION

DO NOT BURY MORE THAN 36 IN. OF REFRIGERANT PIPE IN THE GROUND. If any section of pipe is buried, there must be a 6-in. vertical rise to the valve connections on the outdoor unit. If more than the recommended length is buried refrigerant may migrate to cooler, buried section during extended periods of system shutdown. This causes refrigerant slugging and could possibly damage the compressor at start-up.

When more than 50 ft of interconnecting tubing and more than 30 ft of vertical lift is used, consult the residential long line application instruction guide. For long-line applications, interconnecting lines over 100 ft must be installed with a liquid line solenoid. A liquid line solenoid may also be installed on some units to improve part-load efficiency. Refer to the ARI (Air Conditioning & Refrigeration Institute) Directory.

If either refrigerant tubing or indoor coil is exposed to the atmosphere, the system must be evacuated following good refrigeration practices.

Run refrigerant tubes as directly as possible, avoiding unnecessary turns and bends. Suspend refrigerant tubes so they do not damage insulation on vapor tube and do not transmit vibration to structure. Also, when passing refrigerant tubes through a wall, seal the opening so that vibration is not transmitted to structure. Leave some slack in refrigerant tubes between structure and outdoor unit to absorb vibration. Refer to separate indoor unit installation instructions for additional information.

CHECK ACCURATER CONTROL — The correct AccuRater (bypass type) refrigerant control is required for system capacity optimization. An AccuRater device with field-replaceable piston (see Fig. 4) is supplied with the outdoor unit. Refer to the AccuRater metering device table in separate indoor unit installation instructions to determine the correct AccuRater piston size required for the condenser/evaporator system being installed.

Piston style as shown in Fig. 4 is shipped with the unit. Do not interchange components between the AccuRater device types. Matching of outdoor unit with indoor unit may require field replacement of piston. Replace piston, if required, before connecting refrigerant lines. See Fig. 4. Piston replacement instructions are included in the indoor unit installation instructions. After system installation is complete, see the Refrigerant Charging section on page 12 to check and/or adjust refrigerant charge.

FILTER DRIER — The filter drier must be replaced whenever the refrigeration system is exposed to the atmosphere. See Fig. 4 for filter drier installation.

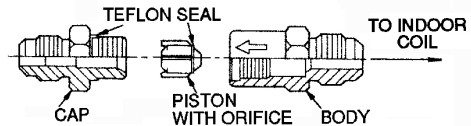

NOTE: Arrow on AccuRater body points in free flow direction, away from the indoor coil.

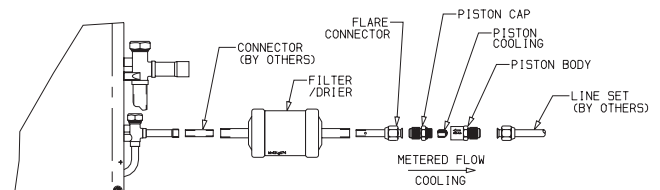

38HDF018-036

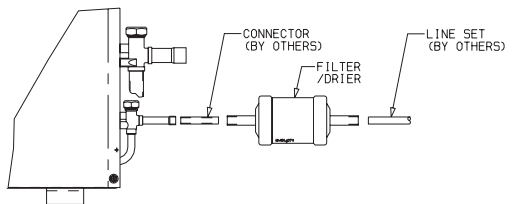

38HDR018-060

Fig. 4 — AccuRater (Bypass Type) Metering Device Components

Only use factory specified liquid-line filter driers with rated working pressures less than 600 psig.

NOTE: Do not install a suction-line filter drier in liquid line.

MAKE PIPING SWEAT CONNECTIONS — Remove plastic caps from liquid and suction service valves. Use refrigerant grade tubing. Service valves are closed from the factory and are ready for brazing. After wrapping the service valve with a wet cloth, the tubing set can be brazed to the service valve using either silver bearing or non-silver bearing brazing material. Consult local code requirements. Refrigerant tubing and the indoor coil are now ready for leak testing.

NOTE: Unit is shipped with R-410A factory charge indicated on nameplate.

Pass nitrogen or other inert gas through piping while brazing to prevent formation of copper oxide.

⚠ CAUTION

To avoid damage while brazing, service valves should be wrapped with a heat-sinking material such as a wet cloth.

⚠ CAUTION

When brazing tubing sets to the service valves, a brazing shield **MUST** be used to prevent damage to the painted unit surface.

PROVIDE SAFETY RELIEF — A fusible plug is located in unit suction line; do not cap this plug. If local code requires additional safety devices, install as directed.

Table 1A — 38HDF018-036 Physical Data

UNIT 38HDF	018	024	030	036
NOMINAL CAPACITY (Tons)	1.5	2.0	2.50	3.0
OPERATING WEIGHT (lb)	166	176	187	250
REFRIGERANT TYPE	R-410A			
METERING DEVICE	AccuRater (Located at Fan Coil)			
CHARGE (lb)*	4.8	5.3	5.0	7.1
OUTDOOR FAN				
Rpm/Cfm	840/1720	840/1720	840/1720	850/1720
Diameter (in.)	18	18	18	24
No. Blades	3	3	3	3
Motor (hp)	1/8	1/8	1/8	1/4
OUTDOOR COIL				
Face Area (sq ft)	5.82	7.27	7.27	12.1
No. Rows	2	3	3	2
FPI	20	20	20	20
HIGH PRESSURE SWITCH				
Cut-In (psig)	420 ± 25	420 ± 25	420 ± 25	420 ± 25
Cutout (psig)	650 ± 10	650 ± 10	650 ± 10	650 ± 10
LOW PRESSURE SWITCH				
Cut-In (psig)	45 ± 25	45 ± 25	45 ± 25	45 ± 25
Cutout (psig)	20 ± 5	20 ± 5	20 ± 5	20 ± 5
REFRIGERANT LINES				
Connection Type			Sweat	
Liquid Line (in.) OD	3/8	3/8	3/8	3/8
Vapor Line (in.) OD	5/8	5/8	3/4	3/4
Max Length (ft)	200	200	200	200
Max Lift (ft)	65	65	65	65
Max Drop (ft)	150	150	150	150
COMPRESSOR				
Type			Scroll	
Model	ZP16K5E-PFV	ZP21K5E-PFV	ZP25K5E-PFV	ZP34K5P-PFV
Oil Charge (POE - oz)	25.0	25.0	25.0	42.0
Accumulator			Yes	
CONTROLS				
Fusible Plug (F)			210	
Control Voltage†			24 vac	
System Voltage	208/230 v	208/230 v	208/230 v	208/230 v, Single and 3 Phase, 460 v, 3 Phase
FINISH	Gray			

LEGEND
FPI — Fins Per Inch
POE — Polyol Ester

*Unit shipped with full factory charge. See ARI (Air Conditioning and Refrigeration Institute) capacity table for proper charge and piston for each fan coil type.
 †24 v and a minimum of 40 va is provided in the fan coil unit.

Table 1B — 38HDR018-060 Physical Data

UNIT 38HDR	018	024	030	036	048	060
NOMINAL CAPACITY (Tons)	1.5	2.0	2.50	3.0	4.0	5.0
OPERATING WEIGHT (lb)	166	176	250	250	278	306
REFRIGERANT TYPE	R-410A					
METERING DEVICE	AccuRater (Located at Fan Coil)					
CHARGE (lb)*	6.3	6.5	10.0	8.9	12.0	12.2
OUTDOOR FAN						
Rpm/Cfm	840/1720	840/1720	850/3900	850/3900	850/3900	850/3900
Diameter (in.)	18	18	24	18	24	24
No. Blades	3	3	3	3	3	3
Motor (hp)	1/8	1/8	1/4	1/4	1/4	1/4
OUTDOOR COIL						
Face Area (sq ft)	5.8	7.3	12.1	12.1	14.1	14.1
No. Rows	2	3	2	2	3	3
FPI	20	20	20	20	20	20
HIGH PRESSURE SWITCH						
Cut-In (psig)	420 ± 25	420 ± 25	420 ± 25	420 ± 25	420 ± 25	420 ± 25
Cutout (psig)	650 ± 10	650 ± 10	650 ± 10	650 ± 10	650 ± 10	650 ± 10
LOW PRESSURE SWITCH						
Cut-In (psig)	45 ± 25	45 ± 25	45 ± 25	45 ± 25	45 ± 25	45 ± 25
Cutout (psig)	20 ± 5	20 ± 5	20 ± 5	20 ± 5	20 ± 5	20 ± 5
REFRIGERANT LINES						
Connection Type	Sweat					
Liquid Line (in.) OD	3/8	3/8	3/8	3/8	3/8	3/8
Vapor Line (in.) OD	5/8	5/8	3/4	3/4	7/8	7/8†
Max Length (ft)	200	200	200	200	200	200
Max Lift (ft)	65	65	65	65	65	65
Max Drop (ft)	150	150	150	150	150	150
COMPRESSOR						
Type	Scroll					
Model	ZP16K5E-PFV	ZP21K5E-PFV	ZP25K5E-PFV	ZP29K5E-PFV	ZP42K5E-PFV	ZP51K5E-PFV
Oil Charge (POE - oz)	25.0	25.0	25.0	25.0	42.0	42.0
Crankcase Heater (watts)	—	—	40	40	40	40
Accumulator	Yes					
CONTROLS						
Fusible Plug (F)	210					
Control Voltage**	24 vac					
System Voltage	208/230 v	208/230 v	208/230 v	208/230 v, Single and 3 Phase, 460 v, 3 Phase		
FINISH	Gray					

LEGEND

FPI — Fins Per Inch
 POE — Polyol Ester

*Unit shipped with full factory charge. See ARI (Air Conditioning and Refrigeration Institute) capacity table for proper charge and piston for each fan coil type.

†Valve connection size is 7/8 inch. Recommended line size is 1 1/8 inches.

**24 v and a minimum of 40 va is provided in the fan coil unit.

Step 4 — Make Electrical Connections

⚠ WARNING

Unit cabinet must have an uninterrupted, unbroken electrical ground to minimize the possibility of personal injury if an electrical fault should occur. This ground may consist of electrical wire connected to unit ground lug in control compartment, or conduit approved for electrical ground when installed in accordance with NEC, and local electrical codes. Failure to follow this warning could result in the installer being liable for the personal injury of others.

⚠ CAUTION

Unit failure as a result of operation on improper line voltage or excessive phase imbalance constitutes abuse and may cause damage to electrical components. Such operation would invalidate any applicable Carrier warranty.

⚠ WARNING

Before performing service or maintenance, be sure indoor unit main power switch is turned OFF and indoor blower has stopped. Failure to do so may result in electrical shock or injury from rotating fan blades.

CONTROL CIRCUIT WIRING — Control voltage is 24 v (40 va minimum). See Fig. 5 and unit label diagram for field-supplied wiring details. Route control wire through opening in unit side panel to connection in unit control box.

NOTE: For wire runs up to 50 ft, use no. 18 AWG (American Wire Gage) insulated wire. For 50 to 75 ft, use no. 16 AWG insulated wire. For over 75 ft, use 14 AWG insulated wire.

NOTE: All wiring must conform to NEC and local codes.

NOTE: Operating unit on improper line voltage constitutes abuse and could affect Carrier warranty. See Tables 2 and 3. *Do not* install unit in a system where voltage may fluctuate above or below permissible limits.

See Tables 2 and 3 for recommended fuse sizes. When making electrical connections, provide clearance at the unit for refrigerant piping connections.

NOTE: The 38HDF units are supplied with a 24-v control transformer. The 38HDR units use the control transformer supplied with the matched indoor unit.

POWER WIRING — Unit is factory wired for voltage shown on nameplate. Provide adequate, fused disconnect switch within sight from unit, readily accessible, but out of reach of children. Provision for locking the switch open (off) is advisable to prevent power from being turned on while unit is being serviced. Disconnect switch, fuses, and field wiring must comply with the NEC and local code requirements. Use copper wire only between the disconnect switch and unit. Use minimum 60 C wire for the field power connection.

Route power wires through the opening in unit side panel and connect in the unit control box as shown on the unit label diagram and Fig. 6 and 7. Unit must be grounded.

CONNECTIONS TO DUCT-FREE FAN COIL UNITS — The 38HDR units are designed for easy match-up to 40QA duct free fan coils. This unit provides 24 v power for the outdoor unit from the fan coil. Connect the Y and C terminals of the indoor unit to the Y and C terminals.



NOTE: For more information see schematic inside unit.

Fig. 5 — Typical Control Circuit Connections

Table 2 — 38HDF Electrical Data

38HDF UNIT SIZE	V-PH-Hz	VOLTAGE RANGE*		COMPRESSOR		OUTDOOR FAN MOTOR			MIN CKT AMPS	FUSE/HACR BKR AMPS
		Min	Max	RLA	LRA	FLA	NEC Hp	kW Out		
018	208/230-1-60	187	253	10.0	48.0	0.80	0.125	0.09	13.3	20
024	208/230-1-60	187	253	14.3	58.3	0.80	0.125	0.09	18.7	30
030	208/230-1-60	187	253	15.7	73.0	0.80	0.125	0.09	20.4	35
036	208/230-1-60	187	253	20.0	112.0	1.45	0.25	0.19	26.5	45
	208/230-3-60	187	253	14.7	88.0	1.45	0.25	0.19	19.8	30
	460-3-60	414	506	6.6	44.0	0.80	0.25	0.19	9.1	15

LEGEND

- FLA** — Full Load Amps
- HACR** — Heating, Air Conditioning, Refrigeration
- LRA** — Locked Rotor Amps
- NEC** — National Electrical Code
- RLA** — Rated Load Amps (Compressor)

*Permissible limits of the voltage range at which unit will operate satisfactorily.

NOTES:

1. Control circuit is 24 v on all units and requires an external power source.
2. All motors and compressors contain internal overload protection.
3. In compliance with NEC (U.S.A. Standard) requirements for multi-motor and combination load equipment (refer to NEC Articles 430 and 440), the overcurrent protective device for the unit shall be fuse or HACR breaker.
4. Motor RLA values are established in accordance with UL (Underwriters' Laboratories) Standard 465 (U.S.A. Standard).
5. 38HDF,HDR018-030 units are only available in single-phase voltage.
6. **Unbalanced 3-Phase Supply Voltage**
Never operate a motor where a phase imbalance in supply voltage is greater than 2%. Use the following formula to determine the percentage of voltage imbalance:

$$= 100 \times \frac{\text{max voltage deviation from average voltage}}{\text{average voltage}}$$

EXAMPLE: Supply voltage is 460-3-60.

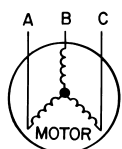

AB = 452 v
BC = 464 v
AC = 455 v

$$\begin{aligned} \text{Average Voltage} &= \frac{452 + 464 + 455}{3} \\ &= \frac{1371}{3} \\ &= 457 \end{aligned}$$

Determine maximum deviation from average voltage:

- (AB) 457 – 452 = 5 v
- (BC) 464 – 457 = 7 v
- (AC) 457 – 455 = 2 v

Maximum deviation is 7 v.

Determine percentage of voltage imbalance:

$$\begin{aligned} \% \text{ Voltage Imbalance} &= 100 \times \frac{7}{457} \\ &= 1.53\% \end{aligned}$$

This amount of phase imbalance is satisfactory as it is below the maximum allowable of 2%.

IMPORTANT: Contact your local electric utility company immediately if the supply voltage phase imbalance is more than 2%.



Table 3 — 38HDR Electrical Data

38HDR UNIT SIZE	V-PH-Hz	VOLTAGE RANGE*		COMPRESSOR		OUTDOOR FAN MOTOR			MIN CKT AMPS	FUSE/HACR BKR AMPS
		Min	Max	RLA	LRA	FLA	NEC Hp	kW Out		
018	208/230-1-60	187	253	10.0	48.0	0.80	0.125	0.09	13.3	20
024	208/230-1-60	187	253	14.3	58.3	0.80	0.125	0.09	18.7	30
030	208/230-1-60	187	253	15.7	64.0	1.45	0.25	0.19	21.1	35
036	208/230-1-60	187	253	15.7	77.0	1.45	0.25	0.19	21.1	35
	208/230-3-60	187	253	10.4	88.0	1.45	0.25	0.19	14.5	20
	460-3-60	414	506	6.3	38.0	0.80	0.25	0.19	8.7	15
048	208/230-1-60	187	253	24.3	117.0	1.45	0.25	0.19	31.8	55
	208/230-3-60	187	253	15.6	83.1	1.45	0.25	0.19	21.0	35
	460-3-60	414	506	6.9	41.0	0.80	0.25	0.19	9.4	15
060	208/230-1-60	187	253	29.4	134.0	1.45	0.25	0.19	38.2	65
	208/230-3-60	187	253	17.8	110.0	1.45	0.25	0.19	23.7	40
	460-3-60	414	506	8.6	52.0	0.80	0.25	0.19	11.6	20

LEGEND

- FLA** — Full Load Amps
- HACR** — Heating, Air Conditioning, Refrigeration
- LRA** — Locked Rotor Amps
- NEC** — National Electrical Code
- RLA** — Rated Load Amps (Compressor)

*Permissible limits of the voltage range at which unit will operate satisfactorily.

NOTES:

1. Control circuit is 24 v on all units and requires an external power source.
2. All motors and compressors contain internal overload protection.
3. In compliance with NEC (U.S.A. Standard) requirements for multi-motor and combination load equipment (refer to NEC Articles 430 and 440), the overcurrent protective device for the unit shall be fuse or HACR breaker.
4. Motor RLA values are established in accordance with UL (Underwriters' Laboratories) Standard 465 (U.S.A. Standard).
5. 38HDF,HDR018-030 units are only available in single-phase voltage.
6. **Unbalanced 3-Phase Supply Voltage**
Never operate a motor where a phase imbalance in supply voltage is greater than 2%. Use the following formula to determine the percentage of voltage imbalance:

$$= 100 \times \frac{\text{max voltage deviation from average voltage}}{\text{average voltage}}$$

EXAMPLE: Supply voltage is 460-3-60.

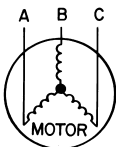

AB = 452 v
BC = 464 v
AC = 455 v

$$\begin{aligned} \text{Average Voltage} &= \frac{452 + 464 + 455}{3} \\ &= \frac{1371}{3} \\ &= 457 \end{aligned}$$

Determine maximum deviation from average voltage:

- (AB) 457 – 452 = 5 v
- (BC) 464 – 457 = 7 v
- (AC) 457 – 455 = 2 v

Maximum deviation is 7 v.

Determine percentage of voltage imbalance:

$$\begin{aligned} \% \text{ Voltage Imbalance} &= 100 \times \frac{7}{457} \\ &= 1.53\% \end{aligned}$$

This amount of phase imbalance is satisfactory as it is below the maximum allowable of 2%

IMPORTANT: Contact your local electric utility company immediately if the supply voltage phase imbalance is more than 2%.

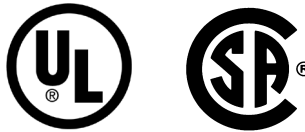

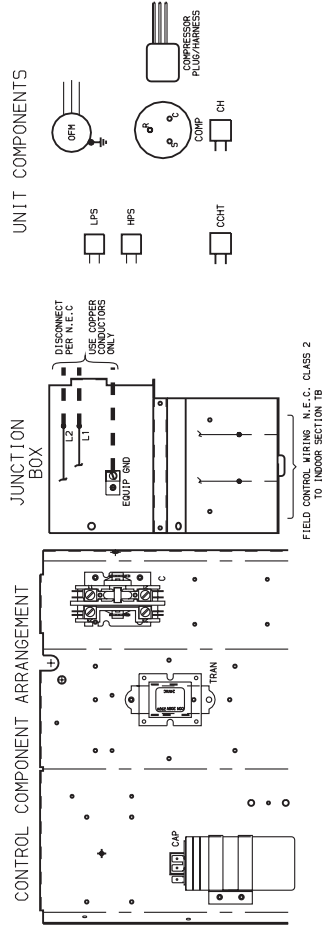







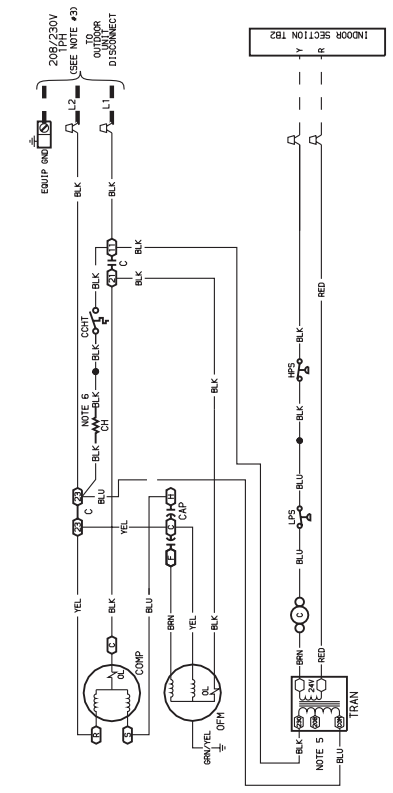



38HDF OPERATION SEQUENCE

CALL FOR COOLING:

1. Control voltage from transformer to thermostat (24 v).
2. At thermostat 24 v is switched to "G" and "Y".
3. 24 v from thermostat "G" energizes fan relay at indoor fan coil unit and indoor-fan motor runs.
4. 24 v from thermostat "Y" energizes the contactor coil and the compressor and outdoor-fan motor will both run.
6. If the internal protection of the compressor or LPS or HPS open, the 24 v to contactor coil will be interrupted. The compressor and outdoor-fan motor will stop.



LEGEND

C — Contactor, Compressor		Terminal (Marked)
CAP — Capacitor		Terminal (Unmarked)
CCHT — Crankcase Heater		Terminal Block
CH — Crankcase Heater		Splice
COMP — Compressor Motor		Factory Wiring
EQUIP — Equipment		Field Control Wiring
GND — Ground		Field Power Wiring
HPS — High-Pressure Switch		Optional or Accessory Wire
LPS — Low-Pressure Switch		Splice (Field)
OFM — Outdoor-Fan Motor		
OL — Overload		
TB — Terminal Board		
TRAN — Transformer		

NOTES:

1. Compressor and fan motors are thermally protected.
2. Wire in accordance with National Electrical Code (NEC) and local codes. Replace any original wires with 90° C wire or its equivalent.
3. Use minimum 60° C wire for field power wiring.
4. Transformer has internal 4.5A thermal fuse on the primary side.
5. Transformer factory wired for 230 v. For 208 v move black wire to 208 volt tap on transformer.
6. Crankcase heater and thermostat used on selected models only.

Fig. 6 — 38HDF018-036 Typical Wiring Schematic

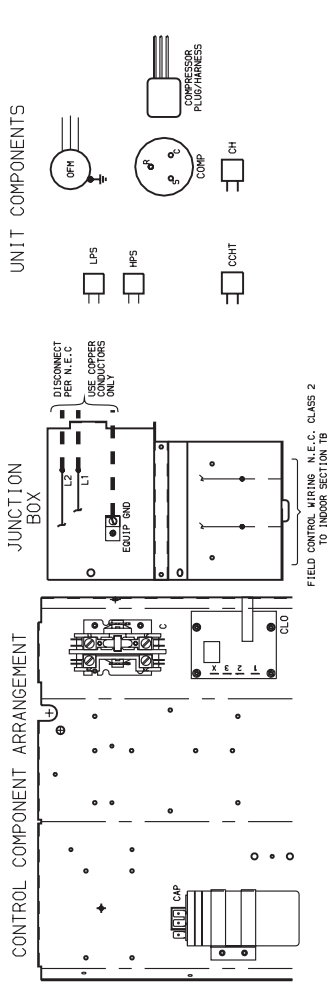

38HDR OPERATION SEQUENCE

CALL FOR COOLING:

1. Control voltage from transformer to thermostat (24 v).
2. At thermostat 24 v is switched to "G" and "Y".
3. 24 v from thermostat "G" energizes fan relay at indoor fan coil and indoor-fan motor runs.
4. 24 v from thermostat "Y" energizes the logic in the CLO, and the contactor coil, both at the outdoor unit. Compressor and outdoor-fan motor run.
5. if the internal protector of the compressor, HPS, or LPS open, the 24 v to the contactor coil will be interrupted, the compressor and outdoor-fan motor will stop, and the CLO will keep the circuit open until reset by stopping and restarting the 24 v power at the thermostat.

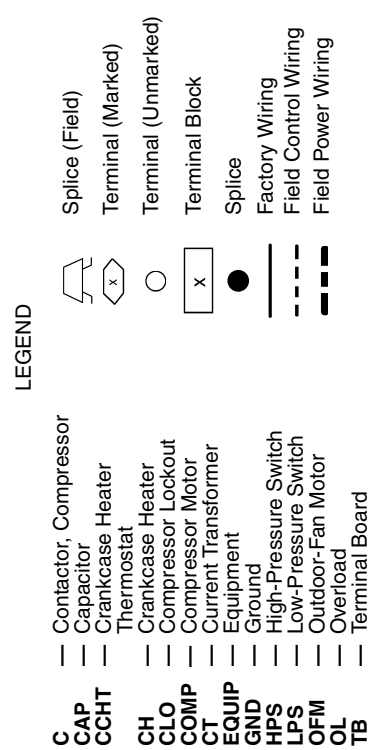
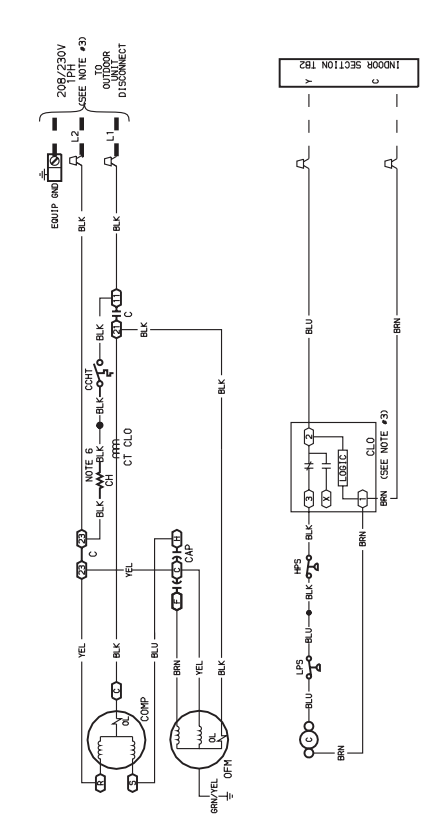

- NOTES:**
1. Compressor and fan motors are thermally protected.
 2. Wire in accordance with National Electrical Code (NEC) and local codes. Replace any original wires with 90° C wire or its equivalent.
 3. The CLO locks out the COMP to prevent short cycling on COMP overloads and safety devices. Before replacing CLO check these devices.
 4. If indoor section has a transformer with a grounded secondary, connect the grounded side to "C" on the low voltage board.
 5. Use minimum 60° C wire for field power wiring.
 6. Crankcase heater and thermostat used on selected models only.

Fig. 7 — 38HDR018-060 Typical Wiring Schematic

START-UP

Preliminary Checks

1. Check that all internal wiring connections are tight and that all barriers, covers, and panels are in place.
2. Field electrical power source must agree with unit name-plate rating.
3. All service valves must be open.
4. Belly-band crankcase heater must be tight on compressor crankcase for those units with belly-band heaters.

Leak Test — Field piping and fan coil must be leak tested by pressure method. Use R-410A at approximately 25 psig backed up with an inert gas to a total pressure not to exceed 245 psig.

Leak detectors should be designed to detect HFC (hydro-fluorocarbon) refrigerant.

Evacuate and Dehydrate — Field piping and fan coil must be evacuated and dehydrated.

Charge System — Release charge into system by opening (backseating) liquid and suction line service valves. Refer to separate indoor unit installation instructions for the required total system charge when connected to 25 ft of tubing.

To Start Unit — Be sure that the field disconnect is closed. Set room thermostat below ambient temperature. Operate unit for 15 minutes, then check system refrigerant charge. See Refrigerant Charging section on page 12.

NOTE: When using in conjunction with 40QA or 40QK fan coils, refer to start-up instructions included with fan coil for correct start-up procedures.

SERVICE

⚠ WARNING

Before performing recommended maintenance, be sure unit main power switch is turned off. Failure to do so may result in electrical shock or injury from rotating fan blade.

Outdoor Fan — A reinforced wire mount holds the outdoor fan assembly in position. See Fig. 8 for proper mounting position.

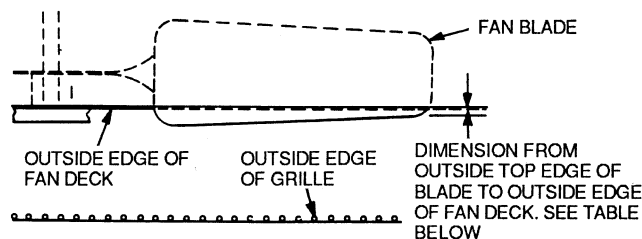

38HDF UNIT SIZE, in.		
018-030	036	
0.433	0	

38HDR UNIT SIZE, in.		
018,024	030,036	048,060
0.433	0	0

Fig. 8 — Condenser-Fan Mounting Positions

High-Pressure Relief Valve — The high-pressure relief valve is located in the compressor. The relief valve opens at a pressure differential of approximately 550 to 625 ± 50 psid between suction (low side) and discharge (high side) to allow pressure equalization.

Internal Current and Temperature Sensitive Overload — The control resets automatically when internal compressor motor temperature drops to a safe level (overloads may require up to 45 minutes to reset). When an internal overload is suspected of being open, check by using an ohmmeter or continuity tester.

Pumpdown Procedure — The system may be pumped down in order to make repairs on the low side without losing complete refrigerant charge.

⚠ CAUTION

Never open system to atmosphere while it is under a vacuum. Equipment damage may result.

When system must be opened for service, recover refrigerant, break vacuum with dry nitrogen before opening system.

1. Attach pressure gage to suction service valve gage port.
2. Frontseat the liquid/mixed phase line valve.

⚠ CAUTION

The 38HDC unit coils hold only the factory-designated amount of refrigerant. Additional refrigerant may cause units to relieve pressure through the compressor internal pressure relief valve (indicated by a sudden rise of suction pressure) before suction pressure reaches 5 psig. If this occurs, shut off unit immediately then frontseat the suction valve and remove and recover excess refrigerant following accepted practices. Equipment damage may result.

3. Start unit and run until suction pressure reaches 20 psig.
4. Shut unit off and frontseat suction valve.
5. Depressurize low side of unit and recover refrigerant following accepted practices.

High-Pressure Switch — The high-pressure switch, located on discharge line, protects against high discharge pressures caused by such events as overcharge, condenser-fan motor failure, system restriction, etc. It opens on pressure rise at about 650 ± 10 psig. If system pressures go above this setting during abnormal conditions, the switch opens.

⚠ WARNING

DO NOT attempt to simulate these system abnormalities — high pressures pose a serious safety hazard.

The high-pressure switch is checked with an ohmmeter. If system pressure is below 625 psig switch shows continuity.

Crankcase Heater — The crankcase heater prevents refrigerant migration and compressor oil dilution during shutdown when compressor is not operating. If the crankcase heater is deenergized for more than 6 hours, both compressor service valves must be closed.

NOTE: Crankcase heaters are only available on 38HDR030-060 units.

The crankcase heater is powered by the high-voltage power of the unit. It is connected across the line side of the contactor and is thermostatically controlled.

⚠ CAUTION

Use extreme caution when troubleshooting this device, as line voltage is continually present. Serious personal injury could result.

To troubleshoot:

1. Apply voltmeter across crankcase heater leads to see if heater voltage is on. *Do not touch heater.* Carefully feel area around crankcase heater; if warm, crankcase heater is functioning.
2. With power off and heater leads disconnected, check across leads with ohmmeter. Do not look for a specific resistance reading. Check for resistance or an open circuit, and change heater if an open circuit is detected.

Service Valves — The service valves in the outdoor unit come from the factory frontseated. This means the refrigerant charge is isolated from the line-set connection ports. To prevent damage to the valve, use a wet cloth or other accepted heat sink material on the valve before brazing.

The service valve cannot be field repaired, therefore, only a complete valve or valve stem seal and service port caps are available for replacement.

Refrigerant Charging

⚠ WARNING

To prevent personal injury, wear safety glasses and gloves when handling refrigerant. Do not overcharge system — this can cause compressor flooding.

⚠ WARNING

Service valves must be fully backseated to close service port. There is no Schrader valve at the service port, and failure to backseat the valve could result in loss of system charge or personal injury.

NOTE: Do not vent or depressurize unit refrigerant to atmosphere. Remove and recover refrigerant following accepted practices.

All units are shipped with the refrigerant charge listed on the nameplate. See indoor unit Installation Instructions for additional charge requirements.

NOTE: For 38HDF units only, charge to nameplate. See the indoor unit owner's manual for any additional charge requirements.

Refer to Table 4 and consider the following when working with Puron® refrigerant:

- Puron refrigerant cylinders are rose colored.
- Recovery cylinder service pressure rating must be 400 psig, DOT (Department of Transportation) 4BA400 or DOT BW400.
- Puron systems should be charged with liquid refrigerant. Use a commercial type metering device in the manifold hose when charging into suction line with compressor operating.
- Manifold sets should be 700 psig high side and 180 psig low side with 550 psig low-side retard.
- Use hoses with 700 psig service pressure rating.
- Puron refrigerant, as with other HFCs, is only compatible with POE oils.
- Vacuum pumps will not remove moisture from oil.
- Polyol Ester oils absorb moisture rapidly. Do not expose oil to atmosphere.
- Polyol Ester oils may cause damage to certain plastics and roofing materials.
- Wrap all filter driers and service valves with wet cloth when brazing.
- A factory approved, liquid-line filter drier is required on every unit.
- Do not use a TXV (thermostatic expansion valve) designed for use with R-22 refrigerant. Refer to separate indoor unit installation instructions for more details.
- If using a suction line drier, do not leave in place for more than 72 hours.

Table 4 — Pressure vs. Temperature Chart — Puron® Refrigerant (R-410A)

PRESSURE PSIG	TEMPERATURE °F	PRESSURE PSIG	TEMPERATURE °F	PRESSURE PSIG	TEMPERATURE °F	PRESSURE PSIG	TEMPERATURE °F	PRESSURE PSIG	TEMPERATURE °F	PRESSURE PSIG	TEMPERATURE °F
12	-37.7	114	37.8	216	74.3	318	100.2	420	120.7	522	137.6
14	-34.7	116	38.7	218	74.9	320	100.7	422	121.0	524	137.9
16	-32.0	118	39.5	220	75.5	322	101.1	424	121.4	526	138.3
18	-29.4	120	40.5	222	76.1	324	101.6	426	121.7	528	138.6
20	-26.9	122	41.3	224	76.7	326	102.0	428	122.1	530	138.9
22	-24.5	124	42.2	226	77.2	328	102.4	430	122.5	532	139.2
24	-22.2	126	43.0	228	77.8	330	102.9	432	122.8	534	139.5
26	-20.0	128	43.8	230	78.4	332	103.3	434	123.2	536	139.8
28	-17.9	130	44.7	232	78.9	334	103.7	436	123.5	538	140.1
30	-15.8	132	45.5	234	79.5	336	104.2	438	123.9	540	140.4
32	-13.8	134	46.3	236	80.0	338	104.6	440	124.2	544	141.0
34	-11.9	136	47.1	238	80.6	340	105.1	442	124.6	548	141.6
36	-10.1	138	47.9	240	81.1	342	105.4	444	124.9	552	142.1
38	-8.3	140	48.7	242	81.6	344	105.8	446	125.3	556	142.7
40	-6.5	142	49.5	244	82.2	346	106.3	448	125.6	560	143.3
42	-4.5	144	50.3	246	82.7	348	106.6	450	126.0	564	143.9
44	-3.2	146	51.1	248	83.3	350	107.1	452	126.3	568	144.5
46	-1.6	148	51.8	250	83.8	352	107.5	454	126.6	572	145.0
48	0.0	150	52.5	252	84.3	354	107.9	456	127.0	576	145.6
50	1.5	152	53.3	254	84.8	356	108.3	458	127.3	580	146.2
52	3.0	154	54.0	256	85.4	358	108.8	460	127.7	584	146.7
54	4.5	156	54.8	258	85.9	360	109.2	462	128.0	588	147.3
56	5.9	158	55.5	260	86.4	362	109.6	464	128.3	592	147.9
58	7.3	160	56.2	262	86.9	364	110.0	466	128.7	596	148.4
60	8.6	162	57.0	264	87.4	366	110.4	468	129.0	600	149.0
62	10.0	164	57.7	266	87.9	368	110.8	470	129.3	604	149.5
64	11.3	166	58.4	268	88.4	370	111.2	472	129.7	608	150.1
66	12.6	168	59.0	270	88.9	372	111.6	474	130.0	612	150.6
68	13.8	170	59.8	272	89.4	374	112.0	476	130.3	616	151.2
70	15.1	172	60.5	274	89.9	376	112.4	478	130.7	620	151.7
72	16.3	174	61.1	276	90.4	378	112.6	480	131.0	624	152.3
74	17.5	176	61.8	278	90.9	380	113.1	482	131.3	628	152.8
76	18.7	178	62.5	280	91.4	382	113.5	484	131.6	632	153.4
78	19.8	180	63.1	282	91.9	384	113.9	486	132.0	636	153.9
80	21.0	182	63.8	284	92.4	386	114.3	488	132.3	640	154.5
82	22.1	184	64.5	286	92.8	388	114.7	490	132.6	644	155.0
84	23.2	186	65.1	288	93.3	390	115.0	492	132.9	648	155.5
86	24.3	188	65.8	290	93.8	392	115.5	494	133.3	652	156.1
88	25.4	190	66.4	292	94.3	394	115.8	496	133.6	656	156.6
90	26.4	192	67.0	294	94.8	396	116.2	498	133.9	660	157.1
92	27.4	194	67.7	296	95.2	398	116.6	500	134.0	664	157.7
94	28.5	196	68.3	298	95.7	400	117.0	502	134.5	668	158.2
96	29.5	198	68.9	300	96.2	402	117.3	504	134.8	672	158.7
98	30.5	200	69.5	302	96.6	404	117.7	506	135.2	676	159.2
100	31.2	202	70.1	304	97.1	406	118.1	508	135.5	680	159.8
102	32.2	204	70.7	306	97.5	408	118.5	510	135.8	684	160.3
104	33.2	206	71.4	308	98.0	410	118.8	512	136.1	688	160.8
106	34.1	208	72.0	310	98.4	412	119.2	514	136.4	692	161.3
108	35.1	210	72.6	312	98.9	414	119.6	516	136.7	696	161.8
110	35.5	212	73.2	314	99.3	416	119.9	518	137.0		
112	36.9	214	73.8	316	99.7	418	120.3	520	137.3		

Subcooling Method — For 38HDR units only, the subcooling method is used to check and adjust charge during the cooling season. Refer to Table 5 and the following procedure:

NOTE: For use with residential fan coils and the 40QA060 under ceiling unit only.

- Operate unit a minimum of 15 minutes before checking charge.
- Measure liquid line temperature near liquid line service valve, and measure the liquid pressure at the liquid line service valve. Use a digital thermometer for all temperature measurements. DO NOT use mercury or dial-type thermometers.
- Refer to Table 5. Find the temperature point at which the required subcooling temperature intersects the measured liquid line pressure.
- If the measured liquid line temperature does not agree with the required liquid line temperature, ADD refrigerant to lower the temperature, or REMOVE refrigerant to raise the temperature (allow a tolerance of $\pm 3^{\circ}$ F).

Table 5 — Subcooling Charging Table

LIQUID PRESSURE AT SERVICE VALVE (psig)	REQUIRED LIQUID LINE TEMPERATURE (F)					
	Required Subcooling Temperature (F)					
	8	10	12	14	16	18
189	58	56	54	52	50	48
195	60	58	56	54	52	50
202	62	60	58	56	54	52
208	64	62	60	58	56	54
215	66	64	62	60	58	56
222	68	66	64	62	60	58
229	70	68	66	64	62	60
236	72	70	68	66	64	62
243	74	72	70	68	66	64
251	76	74	72	70	68	66
259	78	76	74	72	70	68
266	80	78	76	74	72	70
274	82	80	78	76	74	72
283	84	82	80	78	76	74
291	86	84	82	80	78	76
299	88	86	84	82	80	78
308	90	88	86	84	82	80
317	92	90	88	86	84	82
326	94	92	90	88	86	84
335	96	94	92	90	88	86
345	98	96	94	92	90	88
354	100	98	96	94	92	90
364	102	100	98	96	94	92
374	104	102	100	98	96	94
384	106	104	102	100	98	96
395	108	106	104	102	100	98
406	110	108	106	104	102	100
416	112	110	108	106	104	102
427	114	112	110	108	106	104
439	116	114	112	110	108	106
450	118	116	114	112	110	108
462	120	118	116	114	112	110
474	122	120	118	116	114	112
486	124	122	120	118	116	114
499	126	124	122	120	118	116
511	128	126	124	122	120	118

Compressor Lockout Switch — The 38HDR units are provided with a compressor lockout protective device. If the compressor shuts down due to any safety device, a current loop monitoring the compressor current senses no current flow. The unit will lock out until the control power is interrupted to reset the lockout. Determine the reason for the safety trip. To restart, turn the thermostat to the OFF position and then set the thermostat to an operating position.

MAINTENANCE

⚠ WARNING
Before performing recommended maintenance, be sure unit main power switch is turned off. Failure to do so may result in electric shock or injury from rotating fan blade.

Lubrication

COMPRESSOR — Compressor contains factory oil charge; replace oil when lost. Use Mobile 3MA-POE oil.

Cleaning Coils — Coil should be washed out with water or blown out with compressor air. Note that the blow-thru design causes dirt and debris to build up on the inside of the coils.

Clean coil annually or as required by location and outdoor air conditions. Inspect coil monthly and clean as required. Fins are not continuous through coil sections. Dirt and debris may pass through first section, become trapped between the row of fins and restrict condenser airflow. Use a flashlight to determine if dirt or debris has collected between coil sections. Clean coil as follows:

1. Turn off unit power.
2. Using a garden hose or other suitable equipment, flush coil from the outside to remove dirt. Be sure to flush all dirt and debris from drain holes in base of unit. Fan motors are waterproof.

TROUBLESHOOTING

See Fig. 9 for troubleshooting information.

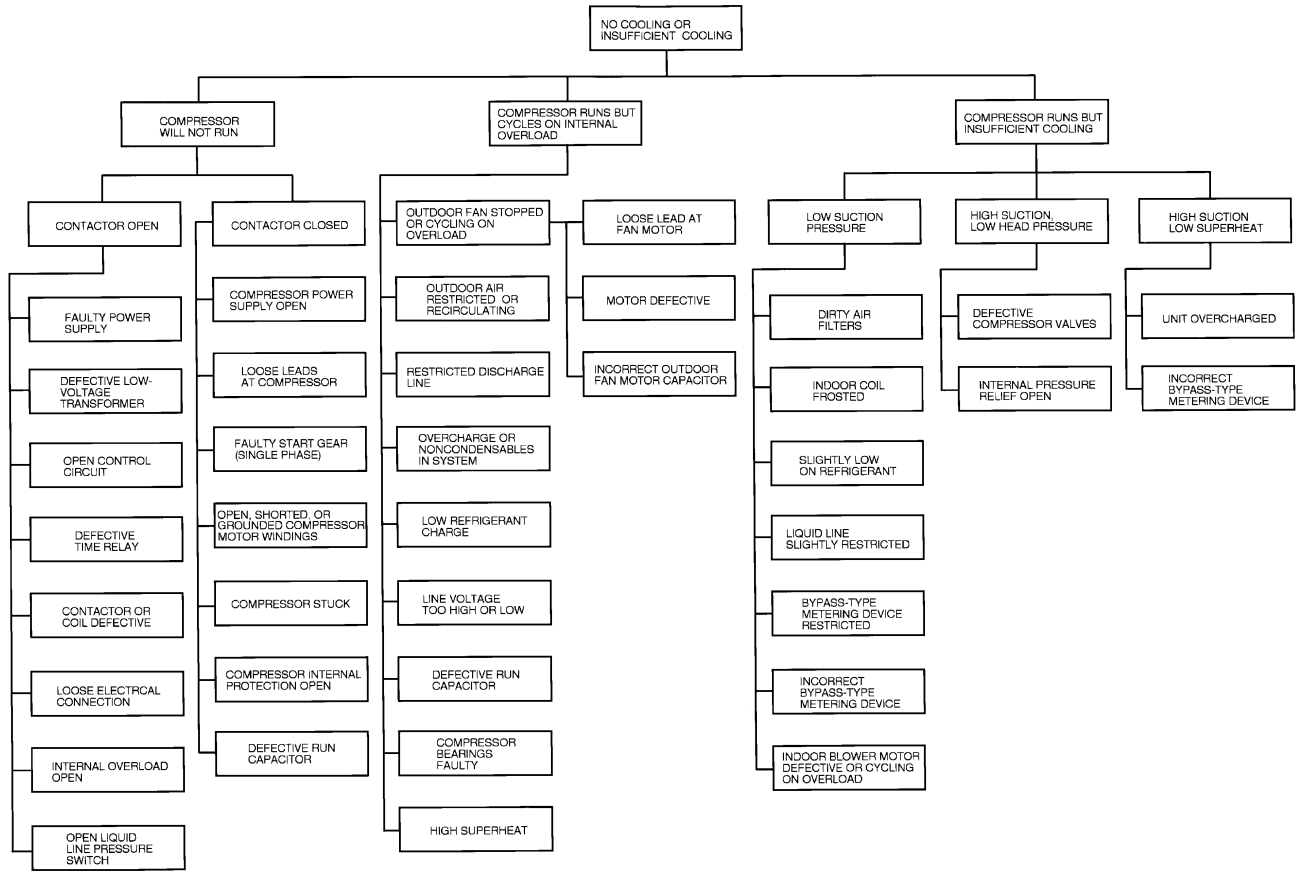

Fig. 9 — Troubleshooting the Cooling Cycle

Manufacturer reserves the right to discontinue, or change at any time, specifications or designs without notice and without incurring obligations.