

## WINESTEWARD<sup>™</sup> WINE COOLER/ EPICURE<sup>®</sup> BEVERAGE CENTER

Models: EF24LBCSS, EF24LWCZ1SS,  
EF24RBCSS, EF24RWCZ1SS



### TABLE OF CONTENTS

Important Safety Instructions .....	1-2
Getting To Know Your Appliance.....	3
Operating Your Appliance .....	4-6
Care and Cleaning .....	7-8
Before You Call for Service.....	9
Warranty and Services .....	10
Notes .....	11-12
Warranty Card .....	Back Cover



To Our Valued Customer:

Congratulations on your purchase of the very latest in Dacor® products! Our unique combination of features, style and performance make us The Life of the Kitchen™, and a great addition to your home.

In order to familiarize yourself with the controls, functions and full potential of your new Distinctive Appliance, read this use and care manual thoroughly, beginning with the **Important Safety Instructions** section.

All Dacor appliances are designed and manufactured with quality and pride, while working within the framework of our company value. Should you ever experience a problem with your product, please first check the **Before You Call for Service** section of this manual for guidance. It provides useful suggestions and remedies prior to calling for service.

Valuable customer input helps us to continuously improve our products and services, so please feel free to contact our Customer Service Team for assistance with any of your product support needs.

Dacor Customer Service Team  
600 Anton Blvd. Suite 1000  
Costa Mesa, CA 92626

Telephone: (800) 793-0093  
Fax: (626) 403-3130  
Hours of Operation: Monday through Friday  
6:00 A.M. to 5:00 P.M. Pacific Time  
Web Site: [www.Dacor.com](http://www.Dacor.com)

Thank you for choosing Dacor for your home. We are a company built by families for families and we are dedicated to serving yours. We are confident that your new Dacor product will deliver a high level of performance and enjoyment for many years to come.

Sincerely,

*The Dacor Customer Service Team*

# Important Safety Instructions

**INSTALLER:** Leave these instructions with the appliance.

**CUSTOMER:** Read this use and care manual completely before using your appliance. Save it for future reference. It contains important use and care information. Retain your sales receipt or canceled check. Proof of original purchase date is required for warranty service.

**For warranty and service information, see page 10.**

If you have any questions (other than warranty questions), call:

Dacor Customer Service  
(800) 793-0093 (U.S.A. and Canada)  
Monday — Friday 6:00 A.M. to 5:00 P.M. Pacific Time

Web site: [www.Dacor.com](http://www.Dacor.com)

Have the complete model and serial number identification of your appliance ready. These numbers are found on the product data label located inside the door on the left side. Record these numbers below for easy access.

Model number \_\_\_\_\_

Serial number \_\_\_\_\_

Date of purchase \_\_\_\_\_

Since we continually improve the quality and performance of our products, we may make changes to the appliance without updating this manual. Visit [www.Dacor.com](http://www.Dacor.com) to download the latest version of this manual.

## Important Information About Safety Instructions

The **Important Safety Instructions** and warnings in this manual are not meant to cover all possible problems and situations that can occur. Use common sense and caution when installing, maintaining or operating this or any other appliance.

Always contact the Dacor Customer Service Team about problems or situations that you do not understand.

## Safety Symbols and Labels

### **DANGER**

**DANGER** – Immediate hazards that **WILL** result in severe personal injury or death.

### **WARNING**

**WARNING** – Hazards or unsafe practices that **COULD** result in severe personal injury or death.

### **CAUTION**

**CAUTION** – Hazards or unsafe practices that **COULD** result in minor personal injury or property damage.

### **DANGER**

**IMPORTANT:** To prevent child entrapment and suffocation when discarding an old appliance:

- Take off the door(s).
- Leave the racks in place so children cannot easily climb inside.
- Cut the prongs off the power plug and discard them.
- Cut the power cable off and discard it separately from the old appliance.

**IMPORTANT:** To avoid the possibility of explosion or fire, do not store or use combustible, flammable or explosive vapors and liquids (such as gasoline) inside or in the vicinity of this or any other appliance.

**IMPORTANT:** The interior light emits class 1M laser radiation. To avoid severe eye injury or electric shock, do not remove the light cover or attempt to change the light bulb. Only a qualified service technician should replace the light.

### **WARNING**

**IMPORTANT:** This appliance is equipped with a three prong grounding electric plug for protection against possible electric shock hazards. It must be plugged into a dedicated, grounded, electrical outlet. If only a two prong electrical outlet is available, it is the responsibility of the customer to have it replaced with a dedicated, properly grounded three prong electrical outlet. **Do not under any circumstances:**

- Cut or remove the third (ground) prong from the power cord.
- Use an adapter plug.
- Use a power cord that is frayed or damaged.
- Connect the appliance to an extension cord.

**NOTE:** Use of an electrical outlet with a ground fault interrupter (GFI) is not recommended.

Power cord with three prong grounding plug

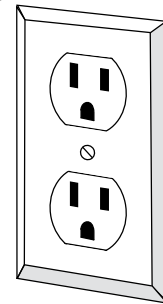
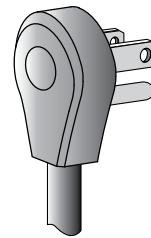

Grounded type electrical outlet

# READ AND SAVE THESE INSTRUCTIONS

# Important Safety Instructions

## General Safety Precautions

To reduce the risk of fire, electric shock, serious injury or death when installing and using your wine cooler or beverage center, follow basic safety precautions, including the following:

### **WARNING**

- If you receive a damaged product, immediately contact your dealer or builder. Do not install or use a damaged appliance.
- Make sure that this appliance has been properly installed by a qualified installer according to the accompanying installation instructions. Have the installer show you the location of the electrical outlet so that you know where and how to disconnect power.
- To prevent personal injury, property damage or damage to the unit, this appliance should only be unpacked and set up by two people according to the accompanying installation instructions.
- Keep packaging materials away from children. Plastic sheets and bags can cause suffocation.
- Connect this appliance to a 115 Vac, 15 Amp. circuit that is controlled by a circuit breaker or fuse. This appliance should have its own separate grounded circuit.
- Do not install, repair or replace any part of the appliance unless specifically recommended in the literature accompanying it. A qualified service technician should perform all other service.
- Before performing any type of service, disconnect the unit from electric power.
- Use this appliance only for its intended purpose, the storage of wine and beverage products. It is not intended for commercial use.
- Never allow anyone, including children to sit, stand or climb on any part of the appliance, including the door. Doing so may cause damage, serious injury or death.
- Do not tamper with the controls.
- If “F0” or “F1” appears on the display, a fault has occurred. Unplug the appliance and contact Dacor customer service.

### **CAUTION**

- To protect the appliance from possible damage, allow it to stand in place 1/2 to 1 hour after moving before turning the electricity on. Doing so allows the refrigerant and system lubrication to reach equilibrium.
- In the event of a power outage, minimize opening the door.
- Do not allow the ventilation grill below the door to become obstructed. Make sure there is always good ventilation in front of the appliance.
- When disconnecting the power cord, do not pull on the cable. Instead, grasp the plug and pull it out of the electrical outlet.

# Getting to Know Your Appliance

## Model Identification

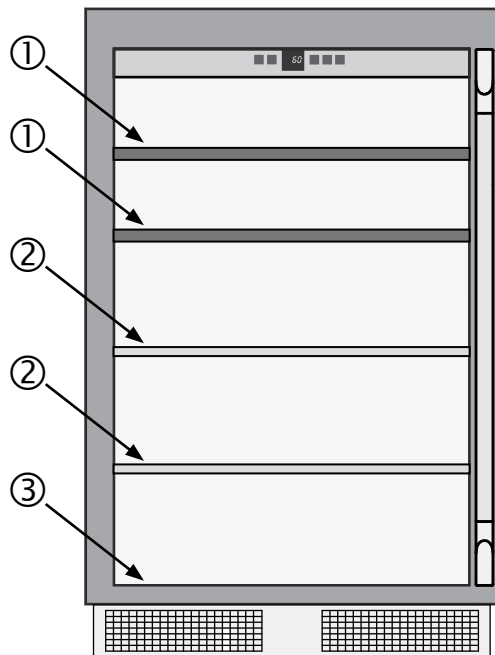

**Beverage Centers:**  
EF24LBCSS (handle on right)  
EF24RBCSS (handle on left)

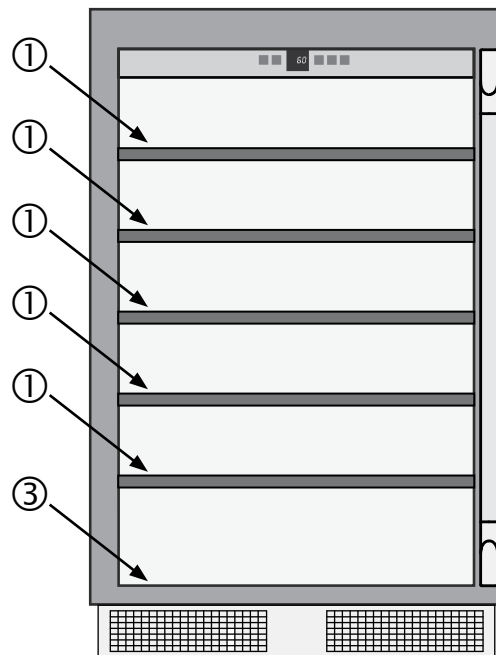

**Wine Coolers:**  
EF24LWCZ1SS (handle on right)  
EF24RWCZ1SS (handle on left)

## Features

### The right environment for your wines...

A vine is an extremely sensitive plant. Grape quality is dependent on three factors: light, air humidity and ambient temperature. This sensitivity continues even after the wine is bottled. To allow a wine's flavor to fully develop and to preserve the excellent aroma, it has to be properly stored. Your wine cooler or beverage center offers the best storage environment:

- ❖ **Wide temperature range:** The unit has a wide temperature adjustment range. It allows you to store wine at low temperature for superb aging or at a higher temperature for serving wine lightly chilled. The temperature on beverage center models can be set between 37 to 68°F (3 to 20°C) The temperature on wine cooler models can be set between 41 to 68°F (5 to 20°C).
- ❖ **Wine cellar simulation:** The fan on your wine cooler or beverage center allows you to simulate the humid conditions inside a wine cellar. High humidity prevents bottle corks from drying out.
- ❖ **High storage capacity:** High storage capacity allows you to preserve the flavor of your favorite wines. The wine cooler models can store 56 750 mL bottles of wine. The beverage center models can store 29 750 mL bottles of wine and 88 eight ounce beverage cans at the same time.

### Rack Locations (see diagrams above)

- ① Slide-out racks: Hold up to nine bottles of wine each
- ② Beverage shelves: Hold up to 44 eight ounce cans each
- ③ Bottom shelf: Holds up to 11 bottles of wine

## Additional Features

- User-friendly electronic controls
- Electronic display
- Adjustable lighting
- Door open alarm
- Child-resistant lock on the control panel
- Easy to clean
- CFC-free
- Low energy consumption
  - 1.5 Amp. @ 115 Vac, 60 Hz. for beverage center models
  - 1.0 Amp. @ 115 Vac, 60 Hz. for wine cooler models

## Temperature Requirements

Your appliance can operate within the room temperature limits listed below. These temperature limits should not be exceeded.

ROOM TEMPERATURE REQUIREMENTS  
FOR PROPER OPERATION

61°F to 90°F (16°C to 32°C)

## Safety Features

- The refrigerant system on this appliance has been tested for leaks.
- This appliance also complies with current safety regulations and EC directives 73/23/EEC and 89/336/EEC.
- In addition, this appliance complies with UL250 and is designed to cool and store wine and beverages.

All specifications subject to change without notice.

# Operating Your Appliance

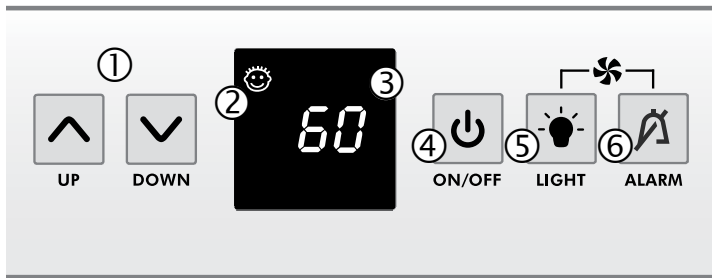

## Loading the Wine Racks

All of the wine racks on your wine cooler or beverage center slide out for easy access except for the bottom shelf.

- Each of the slide out racks can hold up to nine 750 mL Bordeaux bottles.
- The bottom shelf can hold up to 11 Bordeaux bottles.
- For maximum capacity, reverse the position of every other bottle as shown.

## Getting to Know the Control Panel

- ① Temperature setting buttons
- ② Child-resistant lock indicator
- ③ Temperature display
- ④ **ON/OFF** button
- ⑤ Interior **LIGHT** on/off button
- ⑥ **ALARM** on/off button

## Turning the Power ON and OFF

- Clean your appliance before turning it on for the first time. See the **Care and Cleaning** section.
- Connect the power cord to the electrical outlet. The unit will come on.
- The alarm will sound and the temperature display will flash because the beverage compartment is warm when you first turn it on (see the **Alarm** section for details). Push the **ALARM** button to turn the alarm off while the compartment is cooling down to operating temperature. The temperature display will continue to flash until the interior has cooled.
- To turn the unit off, push and hold the **ON/OFF** button for about three seconds. The display will turn off to indicate that the appliance is off.
- To turn it on, push the **ON/OFF** button until the display lights up.

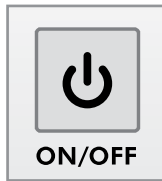

## Setting the Temperature

- Push the **UP** or **DOWN** button repeatedly to raise or lower the temperature. You can change the settings in increments of 1°F (or 1°C). The temperature setting will flash on the display while you change it.
- After five seconds the display will stop flashing and the actual temperature of the compartment will be displayed.

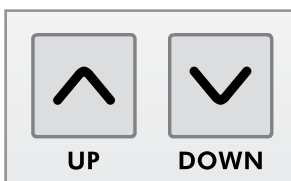

**NOTE:** Depending on the amount of temperature change, it may take a few minutes to a few hours for the compartment temperature to reach the newly adjusted temperature level.



**Bottle Placement**

## Labeling Your Wines

	Yr.: _____ Wine: _____
	Winery: _____

- The front of each slide out rack has a slot for attaching wine labels. Labeling the front of the rack allows you to find the bottle of wine you are looking for without having to pull the racks out and look at the bottle labels.
- You can obtain additional labels from your Dacor dealer or parts distributor.



**Slot for Labels**

# Operating Your Appliance

## Setting Up the Display (Set-up Mode)

In set-up mode you can turn the child resistant lock on and off (see page 6 for details), set the temperature scale to Fahrenheit or Celsius, and adjust the brightness of the display.

### Changing the temperature scale (°F or °C)

You can select the temperature scale that the unit uses to display the temperature settings:

- Push and hold the **LIGHT** button for about five seconds to enter set-up mode. The display will begin to flash.
- Push the **UP** or **DOWN** button repeatedly until the degree symbol “°” flashes on the display.



- Push the **LIGHT** button. “°F” or “°C” will flash on the display.

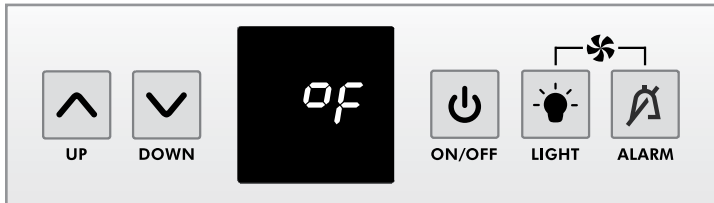

- Push the **UP** or **DOWN** button until the desired temperature scale flashes on the display. Push the **LIGHT** button to select the desired temperature scale.
- Push the **ON/OFF** button to exit set-up mode.

Within about two minutes, the appliance will change the temperature scale on the display.

### Changing the Display Brightness

- Push and hold the **LIGHT** button for about five seconds to enter set-up mode. The display will begin to flash.
- Push the **UP** or **DOWN** button repeatedly until an “h” flashes on the display. Push the **LIGHT** button. The current display brightness level, from 1 to 5 will flash on the display. **h1** is the lowest level. **h5** is the highest level.

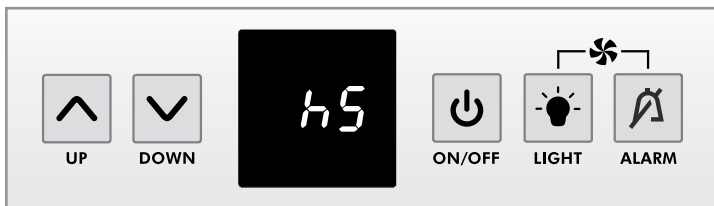

- Push the **UP** or **DOWN** button repeatedly until the desired brightness level flashes on the display. Push the **LIGHT** button to select the desired brightness level.
- Push the **ON/OFF** button to exit set-up mode.

## Turning on the Fan

When storing wine for long periods of time, turn on the fan. The fan will increase the humidity level, which prevents bottle corks from drying out. The fan will run continuously until turned off.

- To turn on the fan, push the **LIGHT** and **ALARM** buttons at the same time.

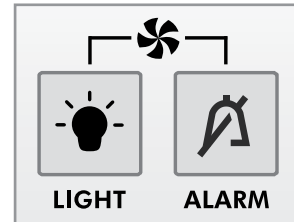

- When the fan is on, pushing the **LIGHT** and **ALARM** buttons at the same time turns it off.

## Alarm

The alarm helps to protect your wines against excessive temperature fluctuations. The alarm sounds when the door is open for longer than about 60 seconds. It also sounds when the interior gets too warm or too cold. The temperature display will also flash. It will continue to flash until the temperature problem has been fixed, even if the alarm has been muted.

- To mute the alarm, push the **ALARM** button.



## Interior Lighting

You can set the interior lighting so that it is on all the time, or so that it comes on only when the door is open.

**To make the light stay on (or turn off) when the door is closed:**

- Push the light button.



# Operating Your Appliance

## Child-Resistant Lock

The child resistant lock feature makes it more difficult for a child to tamper with the controls. The child resistant lock indicator appears on the display when the lock is on.



### To lock (or unlock) the control panel:

- Push and hold the **LIGHT** button for about five seconds to enter set-up mode. The display will begin to flash.
- Push the **UP** or **DOWN** button repeatedly until “c” flashes on the display.

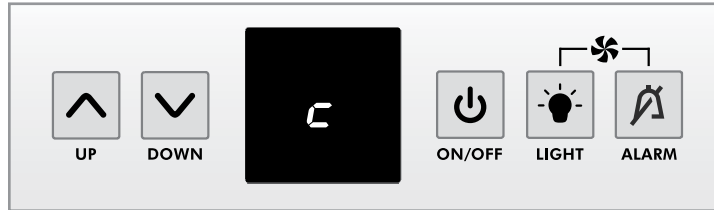

- Push the **LIGHT** button. “c0” or “c1” will flash on the display.
  - **c0** means that the lock is off.
  - **c1** means that the lock is on.

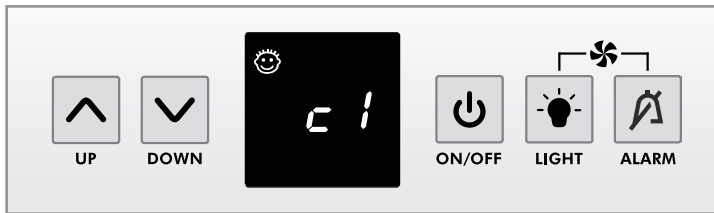

- Push the **UP** or **DOWN** button to select the desired mode. Push the **LIGHT** button to select that mode.
- Push the **ON/OFF** button to exit set-up mode.

## Door Lock (some models)

Some units come equipped with a door lock to prevent unauthorized access.

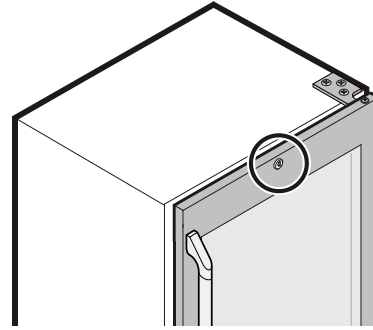

The door is unlocked when the key is in the vertical position and locked when in the horizontal position.

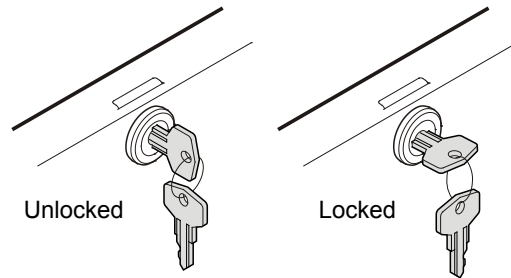

### CAUTION

During locking or unlocking of the door, hold on to the key at all times. The lock cylinder is spring loaded and will eject the key if you release your grip.

### To lock the door:

1. With the door closed, insert the key into the lock as shown below.
2. Turn the key 90° counterclockwise.

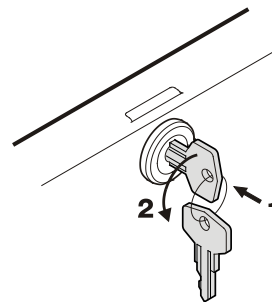

3. Remove the key.

### To unlock the door:

1. Insert the key into the lock.
2. Turn the key 90° clockwise (to the vertical position).



# Care and Cleaning

## **WARNING**

- To avoid possible injury due to electric shock, disconnect the power cord or turn off power at the circuit breaker or fuse box before cleaning the appliance.
- Clean only the parts of the appliance listed in this manual. Clean them only in the manner specified.
- Do not use a steam cleaner to clean this appliance. Steam could penetrate the electrical components and cause a short circuit.
- Do not allow water or cleaning fluids to penetrate into the electrical components or ventilation grill.

## **CAUTION**

To avoid damage to your appliance's surfaces and accessories during cleaning:

- Use only the types of cleaning solutions specified in this manual.
- Do not use abrasives such as steel wool, scouring pads, rough sponges or scrub brushes.

## Defrosting

The compartment of your appliance defrosts automatically. Water may form on the rear wall as part of the defrost process. It drains into a reservoir at the back of the appliance and is heated so that it evaporates.

## Cleaning the Surfaces

### Stainless Steel Surfaces

## **CAUTION**

Always wipe stainless steel (silver colored) surfaces with the grain.

- Clean stainless steel surfaces with a mild solution of detergent and warm water. Rinse and dry with a soft, lint-free cloth.
- You may also use Dacor Stainless Steel Cleaner (Dacor PN A302) on the stainless steel surfaces. Use it according to the directions on the package.
- Stainless steel that is exposed to chlorine gas and moisture may have some discoloration. This discoloration is normal. If your unit is used in this type of environment, clean and polish your stainless steel more often.
- If the surface discolors or rust appears, clean it quickly with a non-abrasive cloth and protect it.

### Glass Surfaces

- To remove finger prints on glass surfaces, use a mild glass cleaner with a soft damp rag.

### Other Surfaces

- Clean all other surfaces with a soft damp rag. You may soak the rag with a mild detergent solution.

## Replacing the Filter

Air quality is an important part of preserving and maturing good wine. To maintain good air quality, your Dacor wine cooler or beverage center is equipped with an activated charcoal filter. It is located on the rear wall.

Dacor recommends that you replace the filter at least once a year. Filters (Dacor PN 101844) can be obtained from your Dacor dealer, parts distributor or at [www.everythingdacor.com](http://www.everythingdacor.com).

### To remove the old filter:

1. Disconnect the power cord from the electrical outlet or turn off power at the circuit breaker or fuse box.
2. Hold the filter by the handle in the center.
3. Turn it 90° to the left or right. Pull it out.

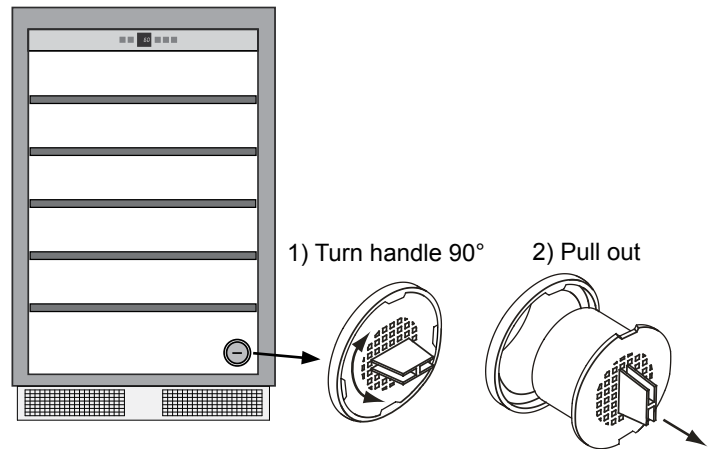

### To install the new filter:

1. Insert it with the handle in the vertical position.
2. Turn it 90° to the left or right until it clicks into place.
3. Reconnect the power.

# Care and Cleaning

## The Light

### **WARNING**

**IMPORTANT:** The interior light emits class 1M laser radiation. To avoid severe eye injury or electric shock, **do not** remove the light cover or attempt to change the light bulb. Only a qualified service technician should replace the light. The location of the light is shown below only so that the customer can determine if it is working.

The light fixture is mounted in the ceiling toward the front of the unit. If it is not working, call your dealer or Dacor Customer Service to have it replaced.

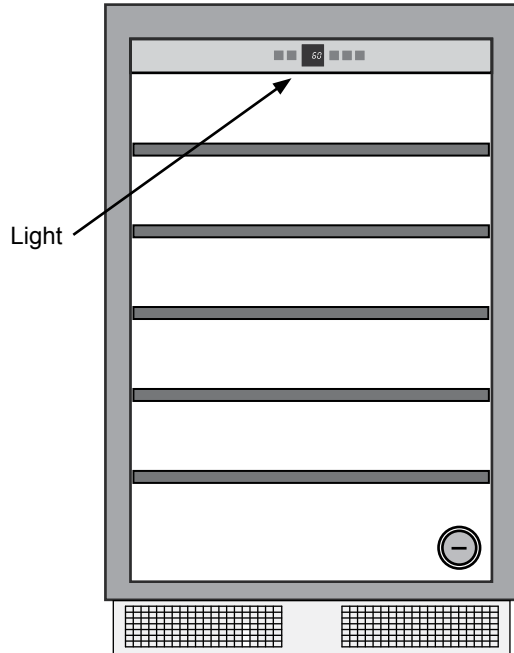

# Before You Call for Service

## Problem Solution Guide

PROBLEM	MAY BE CAUSED BY	WHAT TO DO
Nothing works. Appliance does not cool, control panel display is off and light does not work.	Appliance not connected to electrical power.	Make sure appliance is plugged in.
	Electricity to power outlet is off.	Turn power on at the circuit breaker panel or fuse box. Check for tripped circuit breaker or blown fuse.
	Appliance is turned off.	See <b>Turning the Power On and Off</b> on page 4.
	Power outage.	Contact power company.
Light does not come on.	No power.	See nothing works above.
	Light is turned off.	See <b>Interior Lighting</b> on page 5.
	Light bulb burned out.	Call for service to have it replaced. See <b>Getting Help</b> on page 10 for details.
Loud running noise.	Bottles vibrating.	Adjust bottles and racks to minimize vibration.
	Appliance not standing firmly on floor.	Check appliance leveling according to installation instructions. If problem persists, contact installer. Have installer level appliance or modify installation.
Appliance runs constantly.	Room temperature too hot.	Make sure room temperature is between limits on room temperature chart on page 3. Adjust ventilation system if necessary.
	Door has been left ajar.	Make sure door is firmly shut.
	Appliance mounted too close to heat source.	Have a technician or installer modify the appliance installation or the heat source.
	A lot of bottles added to appliance.	The appliance will run until it has had a chance to cool all the bottles.
Temperature not cold enough.	Temperature not set properly.	See <b>Setting the Temperature</b> on page 4.
	See <b>Appliance runs constantly</b> , above.	
"F0" or "F1" appears on the display.	Appliance has a fault.	Disconnect the power cord. Call for service. See <b>Getting Help</b> on page 10 for details.

# Warranty and Service

## Getting Help

Before you request service, please review the **Before You Call for Service** section on page 9. If you have performed the checks in the **Problem Solution Guide** and the problem has not been remedied, please contact us at one of the numbers below. Prior to requesting service, it is helpful to be familiar with the warranty terms and conditions listed in the **Warranty** section on this page.

**For warranty repairs, call:**

### Dacor Distinctive Service

Phone: (877) 337-3226 (U.S.A. and Canada)  
Business Hours: 6:00 A.M. - 4:00 P.M. Pacific Time

**For a list of Dacor service agents for non-warranty repairs:**

### Dacor Customer Service

Phone: (800) 793-0093 (U.S.A. and Canada)  
Business Hours: 6:00 A.M. - 5:00 P.M. Pacific Time

**Contact us through our web site at:**

[www.Dacor.com](http://www.Dacor.com)

*At Dacor, we believe that our quality of service equals that of our product. Should your experience with our service network or product be different, please contact our Customer Service Team and share your encounter with us. We will do our utmost to resolve the situation for you and deliver on our Dacor promise.*

*If you need anything clarified, just let us know.*

## Warranty

### What Is Covered

#### CERTIFICATE OF WARRANTIES DACOR WINE COOLERS AND BEVERAGE CENTERS

#### WITHIN THE FIFTY STATES OF THE U.S.A., THE DISTRICT OF COLUMBIA, AND CANADA\*:

##### FULL TWO-YEAR WARRANTY

If your DACOR product fails to function within two years of the original date of purchase, due to a defect in material or workmanship, DACOR will remedy the defect without charge to you or subsequent users. The owner must provide proof of purchase upon request, and have the appliance accessible for service.

\* Warranty is null and void if non-CSA approved product is transported from the U.S.

##### FULL FIVE-YEAR WARRANTY

For five years from the date of original purchase, your DACOR warranty covers all parts and labor to repair or replace any components that prove to be defective in materials or workmanship in the sealed system. The "sealed system" means only the compressor, condenser, evaporator, drier, and all connecting tubing.

##### LIMITED 6TH THROUGH 12TH YEAR WARRANTY

From the 6th through 12th year from the date of original purchase, your DACOR warranty covers all parts that prove to be defective in materials or workmanship in the sealed system (parts only).

#### **OUTSIDE THE FIFTY STATES OF THE U.S.A., THE DISTRICT OF COLUMBIA, AND CANADA:**

##### LIMITED TWO YEAR WARRANTY

If your DACOR product fails to function within two years of the original date of purchase, due to a defect in material or workmanship, DACOR will furnish a new part, F.O.B. factory, to replace the defective part. All delivery, installation, and labor costs are the responsibility of the purchaser. The owner must provide proof of purchase, upon request, and have the appliance accessible for service.

##### LIMITED TWELVE YEAR WARRANTY

If your DACOR product fails to function within twelve years of the original date of purchase, due to a defect in material or workmanship of any components in the sealed system, DACOR will furnish a new part, F.O.B. factory, to replace the defective part. All delivery, installation, and labor costs are the responsibility of the purchaser. The owner must provide proof of purchase, upon request, and have the appliance accessible for service. The "sealed system" means only the compressor, condenser, evaporator, drier, and all connecting tubing.

### What Is Not Covered

- Service calls to educate the customer in the proper use and care of the product.
- Failure of the product when used for commercial, business, rental, or any application other than for residential consumer use.
- Replacement of house fuses or fuse boxes, or resetting of circuit breakers.
- Damage to the product caused by accident, fire, flood, or other acts of God.
- Breakage, discoloration or damage to glass, metal surfaces, plastic components, trim, paint, or other cosmetic finish, caused by improper usage or care, abuse, or neglect.

THE REMEDIES PROVIDED FOR IN THE ABOVE EXPRESS WARRANTIES ARE THE SOLE AND EXCLUSIVE REMEDIES. THEREFORE, NO OTHER EXPRESS WARRANTIES ARE MADE, AND OUTSIDE THE FIFTY STATES OF THE UNITED STATES, THE DISTRICT OF COLUMBIA, AND CANADA, ALL IMPLIED WARRANTIES, INCLUDING BUT NOT LIMITED TO, ANY IMPLIED WARRANTY OF MERCHANTABILITY OR FITNESS FOR A PARTICULAR USE OR PURPOSE, ARE LIMITED IN DURATION TO ONE YEAR FROM THE DATE OF ORIGINAL PURCHASE. IN NO EVENT SHALL DACOR BE LIABLE FOR INCIDENTAL EXPENSE OR CONSEQUENTIAL DAMAGES. NO WARRANTIES, EXPRESS OR IMPLIED, ARE MADE TO ANY BUYER FOR RESALE.

Some states do not allow limitations on how long an implied warranty lasts, or do not allow the exclusion or limitation of consequential damages, so the above limitations or exclusions may not apply to you. This warranty gives you specific legal rights, and you may also have other rights that vary from state to state.

# Notes

# Notes

fold here

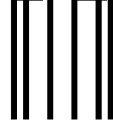

NO POSTAGE  
NECESSARY  
IF MAILED  
IN THE  
UNITED STATES

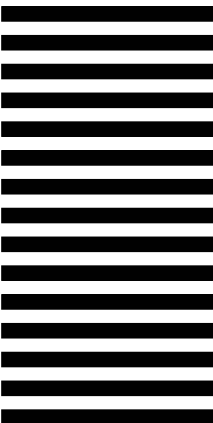

**BUSINESS REPLY MAIL**  
FIRST-CLASS MAIL PERMIT NO 1600 CITY OF INDUSTRY CA

POSTAGE WILL BE PAID BY ADDRESSEE

**DACOR  
ATTN WARRANTY PROCESSING DEPT  
PO BOX 90070  
CITY OF INDUSTRY CA 91715-9907**





Please visit [www.Dacor.com](http://www.Dacor.com) to activate your warranty online.

# WARRANTY INFORMATION



### IMPORTANT:

Your warranty will not be activated until you activate it online or return this form to Dacor. If you have purchased more than one Dacor product, please return all forms in one envelope or activate the warranty for each product online.

Please rest assured that under no conditions will Dacor sell your name or any of the information on this form for mailing list purposes. We are very grateful that you have chosen Dacor products for your home and do not consider the sale of such information to be a proper way of expressing our gratitude!

Owner's Name: \_\_\_\_\_  
Last (Please Print or Type) First Middle

Street: \_\_\_\_\_

City: \_\_\_\_\_ State: \_\_\_\_\_ Zip: \_\_\_\_\_

Purchase Date: \_\_\_\_\_ Email: \_\_\_\_\_ Telephone: \_\_\_\_\_

Dealer: \_\_\_\_\_

City: \_\_\_\_\_ State: \_\_\_\_\_ Zip: \_\_\_\_\_

Your willingness to take a few seconds to fill in the section below will be sincerely appreciated. Thank you.

1. How were you **first** exposed to Dacor products? (Please check one only.)

- A. T.V. Cooking Show
- B. Magazine
- C. Appliance Dealer Showroom
- D. Kitchen Dealer Showroom
- E. Home Show
- F. Builder
- G. Architect/Designer
- H. Another Dacor Owner
- I. Model Home
- J. Other \_\_\_\_\_

2. Where did you buy your Dacor appliances?

- A. Appliance Dealer
- B. Kitchen Dealer
- C. Builder Supplier
- D. Builder
- E. Other \_\_\_\_\_

3. For what purpose was the product purchased?

- A. Replacement **only**
- B. Part of a Remodel
- C. New Home
- D. Other \_\_\_\_\_

4. What is your household income?

- A. Under \$75,000
- B. \$75,000 – \$100,000
- C. \$100,000 – \$150,000
- D. \$150,000 – \$200,000
- E. \$200,000 – \$250,000
- F. Over \$250,000

5. What other brands of appliances do you have in your kitchen?

- A. Cooktop \_\_\_\_\_
- B. Oven \_\_\_\_\_
- C. Dishwasher \_\_\_\_\_
- D. Refrigerator \_\_\_\_\_

6. Would you buy or recommend another Dacor product?

- Yes
- No

Comments: \_\_\_\_\_

Thank you very much for your assistance. The information you have provided will be extremely valuable in helping us plan for the future and giving you the support you deserve.

