

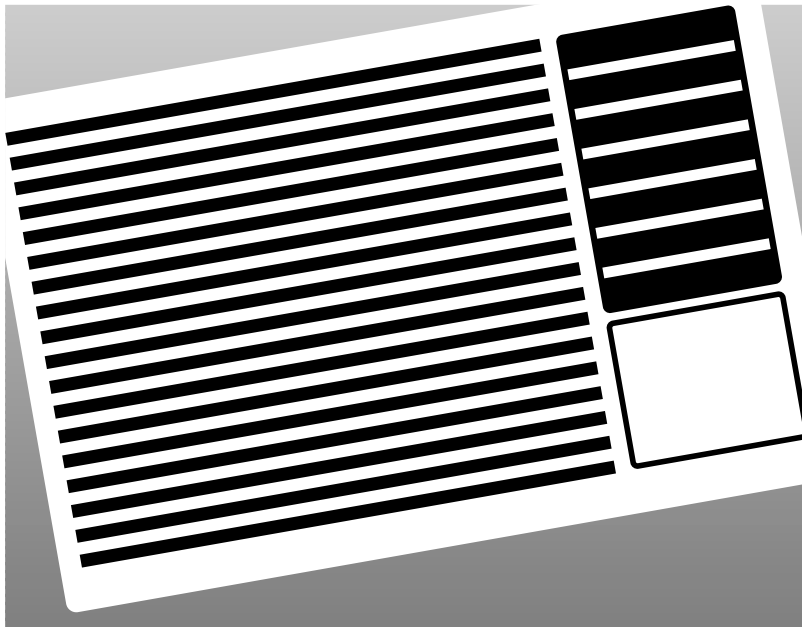

OWNER'S INSTRUCTIONS

AW2400M

WINDOW-TYPE ROOM AIR CONDITIONER (Cool)



Safety Precautions

The following safety precautions must be taken when installing and using your air conditioner.

1 The air conditioner must be plugged into its own specific power source, which must be installed in compliance with national wiring, earthing and safety regulations.

Depending on national regulations and your specific installation, you may need to install:

- ◆ A circuit breaker

For further information on electrical requirements, contact a professional electrician.

This device must be installed according to the national electrical rules.

2 Make sure that the unit is correctly ventilated at all times; do NOT place clothing or other materials over it.

3 NEVER spill liquids of any kind into the unit. Should this happen, unplug the unit and contact your installation specialist.

4 Do NOT insert anything between the air outlet blades, as it may damage the inner fan and you may be hurt. Keep children away from the unit.

5 If the supply cord is damaged, it must be replaced by the manufacturer, its service agent or similarly qualified persons in order to avoid a hazard.

6 Do NOT attempt to repair the unit yourself. If it is damaged in any way, contact:

- ◆ An authorized service center
- ◆ The dealer from whom you purchased the air conditioner.

7 Do NOT place any blocking objects in front of the unit.

8 If the remote control will not be used for a long time, remove the batteries.

9 Before throwing out the device, it is necessary to pull back the battery cells and get rid of them safely.

10 The appliance is not intended for use by young children or infirm person without supervision; young children should be supervised to ensure that they do not play with the appliance.

11 Do NOT use an extension cord with this product.

CAUTION

The manufacturer does not assume responsibility for accidents or injury caused by an incorrectly installed air conditioner. If you are unsure about installation, contact an installation specialist.

Contents

◆ PREPARING YOUR AIR CONDITIONER	
■ Safety Precautions	2
■ Description of Each Component	4
■ Getting Started	5
◆ OPERATING YOUR AIR CONDITIONER	
■ Cooling Your Room	6
■ Ventilating Your Room	7
■ Switching the Air Conditioner Off	8
■ Selecting Energy Saving Mode	8
■ Adjusting the Air Flow Direction Horizontally	9
■ Adjusting the Air Flow Direction Vertically	9
◆ RECOMMENDATIONS FOR USE	
■ Power Failure	10
■ Temperature and Humidity Ranges	10
■ Cleaning Your Air Conditioner	11
■ Solving Common Problems	12
■ Technical Specifications	13

Description of Each Component

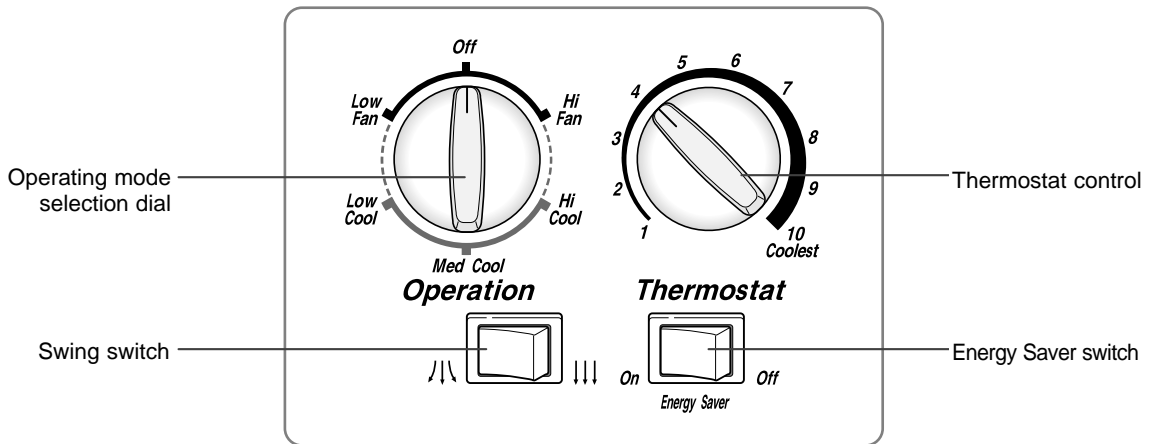
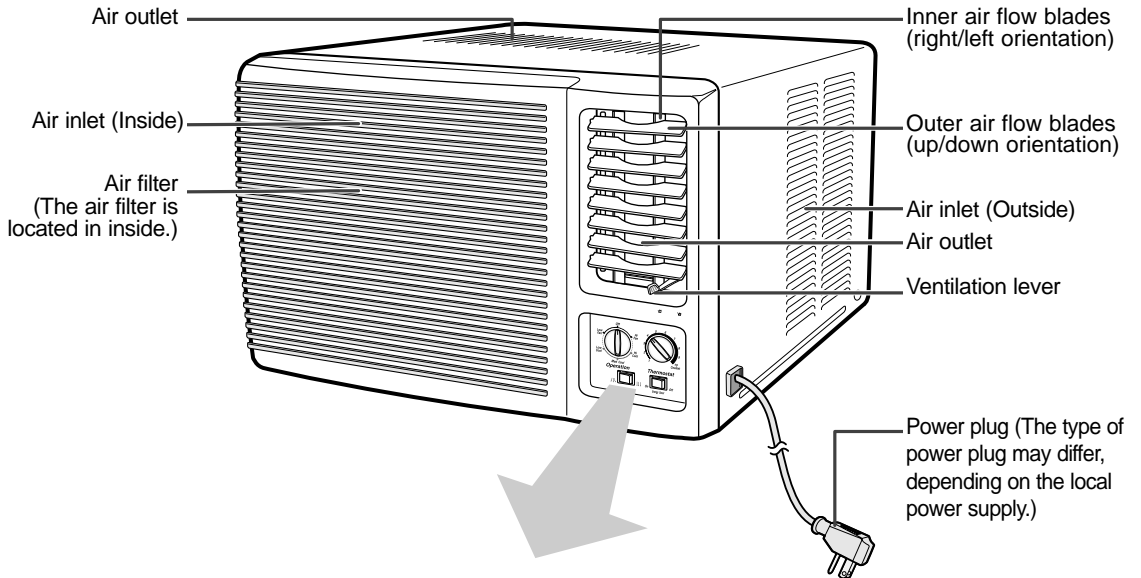

Getting Started

You have just purchased a Samsung window-type room air conditioner which should be installed following your Owner's Instructions.

Your Owner's Instructions contain much valuable information on using your air conditioner. Please take the time to read them as they will help you take full advantage of the unit's features.

The illustrations in the step-by-step procedures use four different symbols:

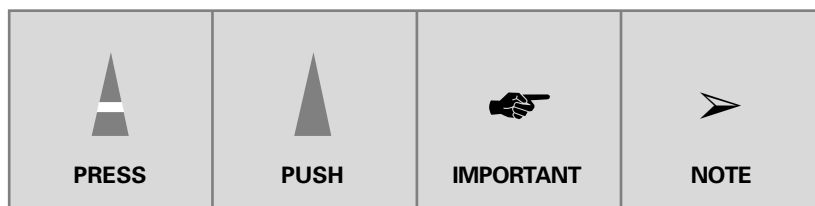

Cooling Your Room

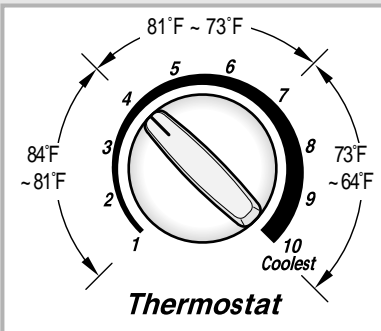
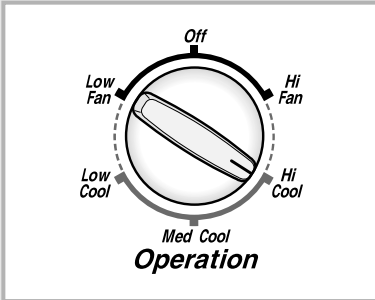

You must select the COOL mode if you wish to adjust the:

- ◆ **Cooling temperature**
- ◆ **Fan speed when Cooling**

- 1 Turn the operating mode selection dial and set it to "HI COOL", "MED COOL" or "LOW COOL".

Result: ◆ The air conditioner starts up in cool mode.

➤ ◆ You can change modes at any time.

- 2 Turn the THERMOSTAT control to the desired position.

Possible temperatures: Can be set between 64°F and 84°F.

Result: The air conditioner starts cooling if the room temperature is higher than the selected temperature.

- 3 To control the direction of the air flow, refer to page 9.

Ventilating Your Room

If the air in your room is stale, you can ventilate the room using the Fan feature.

- 1 If you wish to discharge stale air, push the ventilation lever on the front of the unit to the right and open position ().

Result: The air inside the room circulates and stale air is discharged outside.

Otherwise, push the ventilation lever to the left and closed position ().

Result: The air simply circulates inside the room.

- 2 Turn the operating mode selection dial and set it to "HI FAN" or "LOW FAN" position.

Result: ◆ The air conditioner starts up in fan mode.

- ◆ HI FAN : The fan turns rapidly.
- ◆ LOW FAN : The fan turns slowly.
- ◆ You can change modes at any time.

- 3 To control the direction of the air flow, refer to page 9.

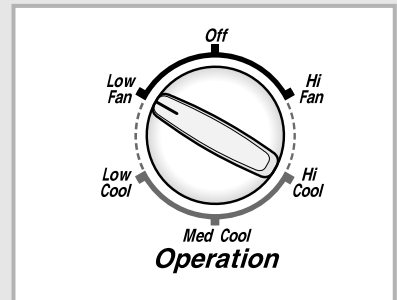
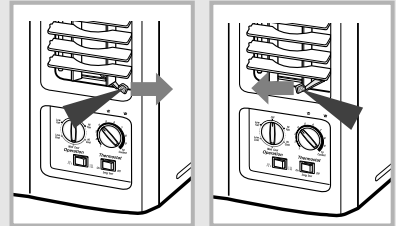

Switching the Air Conditioner Off

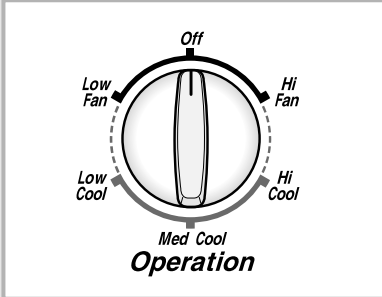

You can switch the air conditioner off whenever you want.

- 1 To switch the unit off, simply set the operating mode selection dial to the "Off" position.

Result: The air conditioner stops operating.

Selecting Energy Saving Mode

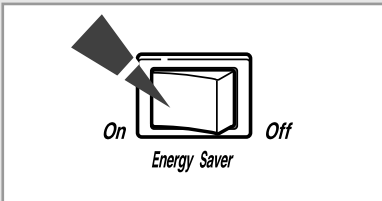

If you wish to save energy when using the air conditioner, select the energy saving mode by using the Energy Saver switch. This feature is normally used when the room is unoccupied.

- 1 To select the energy saving mode, set the Energy Saver switch to the "On" position.

Result: The fan and compressor cycle on and off simultaneously. This results in wider variations of room temperature and humidity.

- If you want to run the air conditioner in Fan mode, do not turn the Energy Saver switch on. The Fan mode will not operate when the Energy Saver switch is in the "On" position.

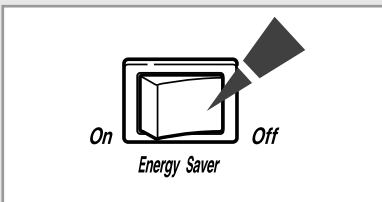

- 2 To turn off the energy saving feature, set the Energy Saver switch to the "Off" position.

Result: The fan runs at all times, while the compressor cycles on and off.

Adjusting the Air Flow Direction Horizontally

The inner air flow blades on the right side of the unit can be adjusted to direct the air flow to the left, right or straight, thus increasing the efficiency of the air conditioner.

- 1 Set the Swing switch to the $\swarrow\searrow$ position.

Result: The inner blades swing automatically left and right.

- 2 To stop the blades moving left and right, set the Swing switch to the $\downarrow\downarrow$ position.

- To stop the blades in a specific position and orient the air flow in the corresponding direction, simply set the switch to the $\downarrow\downarrow$ position when the blades are in the desired position.

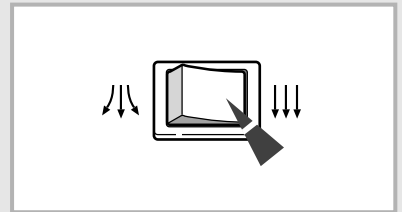
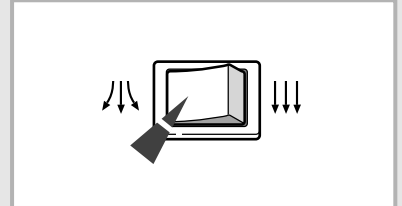

Adjusting the Air Flow Direction Vertically

The outer air flow blades can be adjusted to control the vertical air flow direction.

RECOMMENDATION	When...	Adjust the blades to face...
	Cooling	Upwards.

Adjust the air flow blades to the desired position, by pushing them upwards or downwards.

- ◆ If you orient the air flow blades downwards and the unit operates in Cool mode for long periods of time, dew may:
 - Form on the surface of the blades
 - Drip from the blades

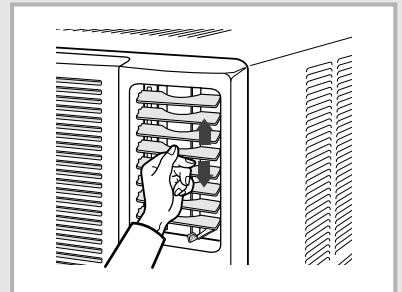

Power Failure

If a power failure occurs, the air conditioner is switched off. When the power comes back on, the air conditioner starts up again automatically.

Temperature and Humidity Ranges

The following table indicates the temperature and humidity ranges within which the air conditioner can be used.

Mode	Indoor Temperature	Outdoor Temperature	Indoor Humidity
Cooling	70°F to 90°F approx.	70°F to 110°F approx.	80% or less

If the air conditioner is used at...	Then...
Higher temperature	The automatic protection feature may be triggered and the air conditioner stopped.
Lower temperature	A water leakage or some other malfunction may happen if the heat exchanger freezes.
Higher humidity levels	Water may condense on and drip from the surface of the unit if it is used for long periods.

Cleaning Your Air Conditioner

Be sure to clean the air filter periodically to maintain the air conditioner in the best condition for a long period of time.

✎ When cleaning the air conditioner, turn it off and pull out the power plug.

- 1 Open the front grille by pulling on the tabs of the unit.
 - The removal of the front grille makes it easier to clean the air conditioner. After opening the front grille, lift it up as much as possible, then pull down to release it.
- 2 Grasp the handle on the air filter and lift it slightly and then out to the front.
- 3 Remove all dust on the air filter with a vacuum cleaner or brush.
- 4 When you have finished, insert the air filter back into its original position.
- 5 Wipe the surface of the unit with a neutral detergent and then wipe it again with dry cloth.
(Be sure not to use benzene, solvent or other chemical products.)

➤ If you...	Then...
Will not be using the air conditioner for a long period of time	<ul style="list-style-type: none">◆ Set the fan going for a few hours to dry the inside of the air conditioner thoroughly.◆ Switch the air conditioner off and unplug it from the wall socket.◆ Clean the filter and outer surfaces.
Have not used the air conditioner for a long period of time	Set the fan going for a few hours to dry the inside of the air conditioner thoroughly.

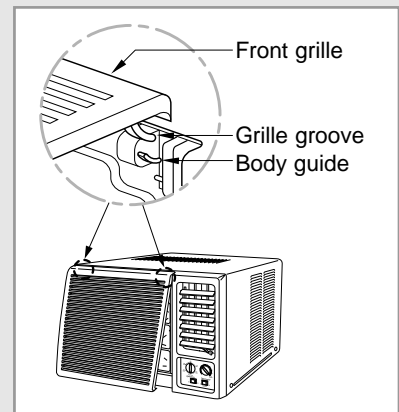
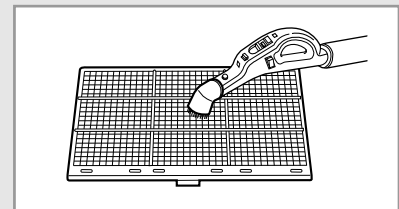
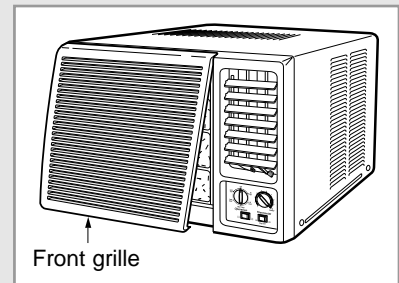

Solving Common Problems

Before contacting an authorized service center, perform the following simple checks. They may save you the time and the expense of an unnecessary call.

Problem	Explanation / Solution
The air conditioner does not operate at all.	<ul style="list-style-type: none">◆ Check for a power failure.◆ Check the voltage. (See the technical specifications)◆ Check the power plug for disconnection.◆ Check to see whether the operating mode selection dial is placed in the "Off" position. (Set it to the desired position.)◆ Check to see whether the room temperature is too low.<ul style="list-style-type: none">- Refer to page 10 for details about temperature condition.
The air comes out smoothly, but cooling is not effective.	<ul style="list-style-type: none">◆ Set the THERMOSTAT control to the desired position.<ul style="list-style-type: none">- When the number on the THERMOSTAT control is high, the room temperature may be too warm.◆ Check to see whether there is any open window or leakage of cool air to the outside.<ul style="list-style-type: none">- Close the window, and fill the gap.◆ Check to see whether there is any obstacle adversely affecting the flow of the air inside and outside the room.<ul style="list-style-type: none">- Remove the obstacle or change the position of the air conditioner.◆ Check to see whether the air filter is clogged with dust or contaminated with foreign substances.<ul style="list-style-type: none">- Clean the air filter.◆ Check to see whether there is any direct sunlight facing the air conditioner.<ul style="list-style-type: none">- Block the sunlight with a sunshade.◆ Check to see whether there is any electric device generating heat.<ul style="list-style-type: none">- Do not use the air conditioner together with any heating device.
The air flow direction does not change when you set the air flow blade swing switch to the  position.	<ul style="list-style-type: none">◆ Check that the air conditioner has been switched on; if necessary, turn the operating mode selection dial. ; refer to page 9.
Odors are permeating the room during air conditioning.	<ul style="list-style-type: none">◆ Ventilate the room.

Technical Specifications

Design and specifications are subject to change without notice.

Model	Power Supply
AW2400M	230 - 208V~, 60Hz

SAMSUNG ROOM AIR CONDITIONER

LIMITED WARRANTY TO ORIGINAL PURCHASER

This SAMSUNG brand product, as supplied and distributed by SAMSUNG ELECTRONICS AMERICA, INC. (SAMSUNG) and delivered new, in the original carton to the original consumer purchaser, is warranted by SAMSUNG against manufacturing defects in materials and workmanship for a limited warranty period of:

One (1) Year Parts and Labor, Five (5) Years Parts Warranty for Compressor

This limited warranty begins on the original date of purchase, and is valid only on products purchased and used in the United States. Warranty repairs must be performed by SAMSUNG's authorized service center. To receive warranty service, the original dated bill of sale must be presented upon request as proof of purchase to SAMSUNG or SAMSUNG's authorized service center.

SAMSUNG will repair or replace any part found to be defective at no charge, as stipulated herein, with new or reconditioned parts during the limited warranty period specified above. To request warranty service, the purchaser must contact SAMSUNG for problem determination and service procedures. SAMSUNG does not warrant uninterrupted or error-free operation of the product. All replaced parts and products become the property of SAMSUNG and must be returned to SAMSUNG. Replacement parts and products assume the remaining original warranty, or ninety(90) days, whichever is longer.

In - Home Service: During the warranty labor period, in-home service will be provided subject to availability within the contiguous United States. In-home service is not available in all areas. If during in-home service repair can not be completed, it may be necessary to remove, repair and return the product. If in-home service is unavailable, SAMSUNG may elect, at our option, to provide for transportation of our choice to and from a SAMSUNG authorized service center. Otherwise, transportation to and from the SAMSUNG authorized service center is the responsibility of the purchaser.

This limited warranty covers manufacturing defects in materials and workmanship encountered in normal, noncommercial use of this product and shall not apply to the following, including, but not limited to: delivery and installation; damage which occurs in shipment; applications and uses for which this product was not intended; failures or problems which are caused by products or equipment not supplied by SAMSUNG; accidents, misuse, abuse, neglect, misapplication, fire, water, lightning or other acts of nature; incorrect electrical line voltage, fluctuations or surges; damage caused by improper or faulty installation; product alteration or modification; improper or unauthorized repair; cosmetic damage or exterior finish; product with altered serial numbers; failure to follow operating and environmental instructions that are covered and prescribed in the instruction book; customer adjustments, routine maintenance and cleaning; consumable items such as filters; use of non-SAMSUNG or unauthorized parts, supplies, accessories or equipment which damage this product or result in service problems.

THERE ARE NO EXPRESS WARRANTIES OTHER THAN THOSE LISTED AND DESCRIBED ABOVE, AND NO WARRANTIES WHETHER EXPRESS OR IMPLIED, INCLUDING, BUT NOT LIMITED TO, ANY IMPLIED WARRANTIES OF MERCHANTABILITY OR FITNESS FOR A PARTICULAR PURPOSE, SHALL APPLY AFTER THE EXPRESS WARRANTY PERIODS STATED ABOVE, AND NO OTHER EXPRESS WARRANTY OR GUARANTY GIVEN BY ANY PERSON, FIRM OR CORPORATION WITH RESPECT TO THIS PRODUCT SHALL BE BINDING ON SAMSUNG. SAMSUNG SHALL NOT BE LIABLE FOR LOSS OF REVENUE OR PROFITS, FAILURE TO REALIZE SAVINGS OR OTHER BENEFITS, OR ANY OTHER SPECIAL, INCIDENTAL OR CONSEQUENTIAL DAMAGES CAUSED BY THE USE, MISUSE OR INABILITY TO USE THIS PRODUCT, REGARDLESS OF THE LEGAL THEORY ON WHICH THE CLAIM IS BASED, AND EVEN IF SAMSUNG HAS BEEN ADVISED OF THE POSSIBILITY OF SUCH DAMAGES. NOR SHALL RECOVERY OF ANY KIND AGAINST SAMSUNG BE GREATER IN AMOUNT THAN THE PURCHASE PRICE OF THE PRODUCT SOLD BY SAMSUNG AND CAUSING THE ALLEGED DAMAGE. WITHOUT LIMITING THE FOREGOING, PURCHASER ASSUMES ALL RISK AND LIABILITY FOR LOSS, DAMAGE OR INJURY TO PURCHASER AND PURCHASERS PROPERTY AND TO OTHERS AND THEIR PROPERTY ARISING OUT OF THE USE, MISUSE OR INABILITY TO USE THIS PRODUCT SOLD BY SAMSUNG NOT CAUSED DIRECTLY BY THE NEGLIGENCE OF SAMSUNG. THIS LIMITED WARRANTY SHALL NOT EXTEND TO ANYONE OTHER THAN THE ORIGINAL PURCHASER OF THIS PRODUCT, IS NONTRANSFERABLE AND STATES YOUR EXCLUSIVE REMEDY.

Some states do not allow limitations on how long an implied warranty lasts, or the exclusion or limitation of incidental or consequential damages, so the above limitations or exclusions may not apply to you. This warranty gives you specific legal rights, and you may also have other rights which vary from state to state.

To obtain warranty service, please contact SAMSUNG at:

SAMSUNG ELECTRONICS AMERICA, INC. - CONSUMER ELECTRONICS CUSTOMER SERVICE

400 Valley Road, Suite 201 Mount Arlington, NJ 07856

Tel: 973-601-6000, Fax: 973-601-6001

1-800-SAMSUNG (1-800-726-7864)

www.sosimple.com