

Owner's Operating Service Instruction Manual

10¢

- ASSEMBLY
- OPERATION
- REPAIR PARTS

Model Nos.
116-062A
116-072A

20" ROTARY MOWERS

IMPORTANT

It is suggested that this manual be read in its entirety before attempting to assemble or operate. Keep this manual in a safe place for future reference and for ordering replacement parts.

This unit is shipped WITHOUT GASOLINE or OIL. After assembly, see operating section of this manual for proper fuel and amount.

SAFE OPERATION PRACTICES FOR WALK-BEHIND MOWERS

TRAINING

1. Read the Operating and Service Instruction Manual carefully. Be thoroughly familiar with the controls and the proper use of the equipment.
2. Never allow children to operate a power mower.
3. Keep the area of operation clear of all persons, particularly small children and pets.

PREPARATION

1. Thoroughly inspect the area where the equipment is to be used and remove all stones, sticks, wire, bones and other foreign objects.
2. Do not operate equipment when barefoot or wearing open sandals. Always wear substantial footwear.
3. Check the fuel before starting the engine. Do not fill the gasoline tank indoors, when the engine is running, or while the engine is still hot. Wipe off any spilled gasoline before starting the engine.
4. Disengage the self-propelled mechanism or drive clutch on units so equipped before starting the engine.
5. Never attempt to make a wheel adjustment while the engine is running.
6. Mow only in daylight or in good artificial light.
7. Never operate the equipment in wet grass. Always be sure of your footing; keep a firm hold on the handle and walk, never run.

OPERATION

1. Do not change the engine governor settings or overspeed the engine.
2. Do not put hands or feet near or under rotating parts. Keep clear of the discharge opening at all times.
3. Stop the blade(s) when crossing gravel drive, walks or roads.
4. After striking a foreign object, stop the engine, remove the wire from the spark plug, thoroughly inspect the mower for any damage, and repair the damage before restarting and operating the mower.

5. If the equipment should start to vibrate abnormally, stop the engine and check immediately for the cause. Vibration is generally a warning of trouble.
6. Stop the engine whenever you leave the equipment, before cleaning the mower housing, and when making any repairs or inspections.
7. When cleaning, repairing or inspecting, make certain the blade and all moving parts have stopped. Disconnect the spark plug wire, and keep the wire away from the plug to prevent accidental starting.
8. Do not run the engine indoors.
9. Shut the engine off and wait until the blade comes to a complete stop before removing the grass catcher or unclogging chute.
10. Mow across the face of slopes, never up-and-down. Exercise extreme caution when changing direction on slopes. Do not mow excessively steep slopes.
11. Always disconnect electric mowers (line operated) before cleaning, repairing or adjusting.
12. Never operate mower without proper guards, plates or other safety protective devices in place.
13. Keep washout ports and other mower-housing service openings closed when mowing.

MAINTENANCE AND STORAGE

1. Check the blade and engine mounting bolts at frequent intervals for proper tightness.
2. Keep all nuts, bolts, and screws tight to be sure the equipment is in safe working condition.
3. Never store the equipment with gasoline in the tank inside of a building where fumes may reach an open flame or spark. Allow the engine to cool before storing in any enclosure.
4. To reduce fire hazard, keep the engine free of grass, leaves, or excessive grease.
5. Check the grass catcher bag frequently for wear or deterioration. Replace with new bag for safety protection.

HANDLE ASSEMBLY FOR MODEL 116-062A

NOTE: Follow instructions starting with Number 1 and continue through Number 5.

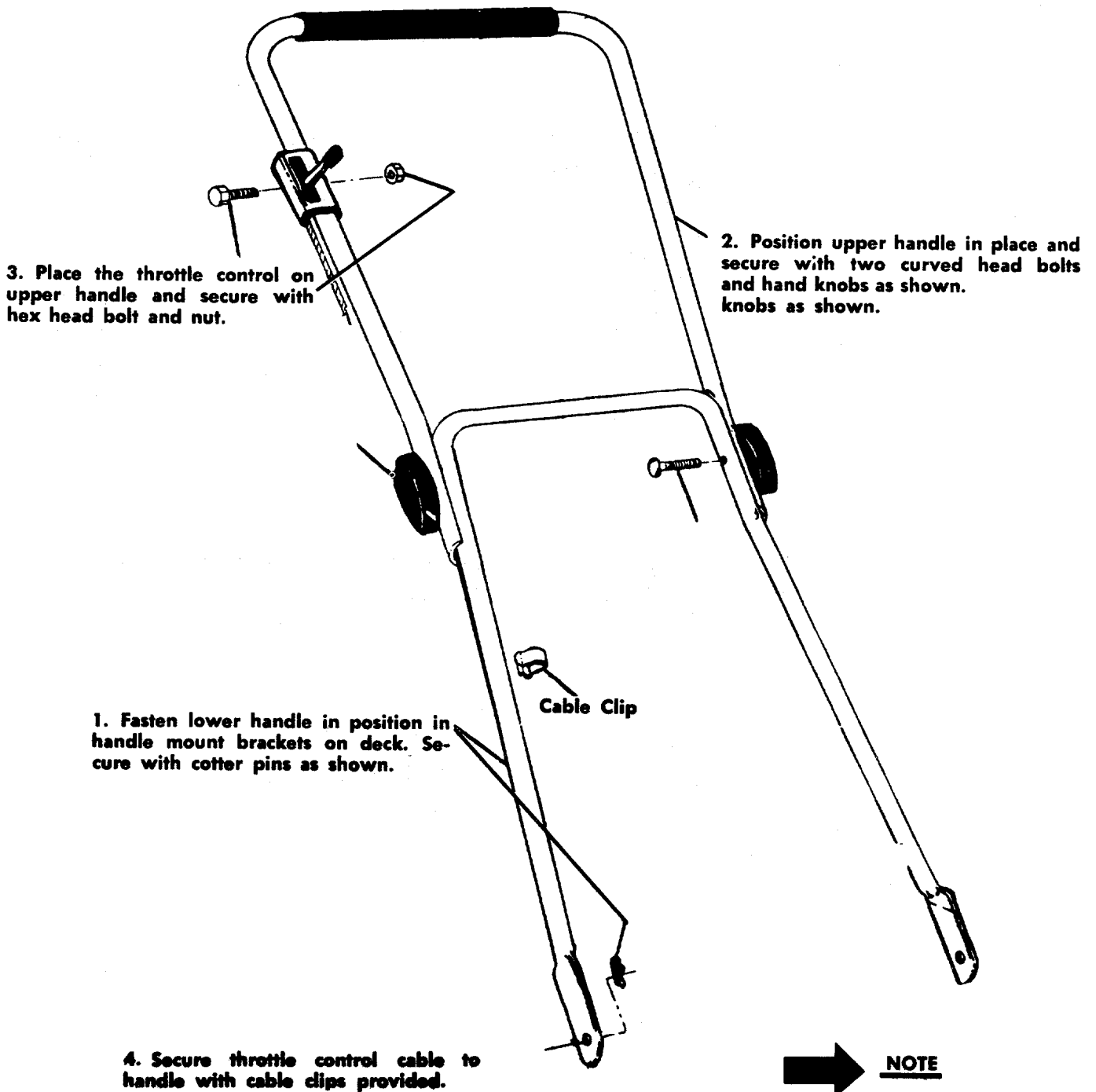

NOTE

It may be necessary to pull open the lower handle. This will insure a tight fit when assembled into handle mount brackets.

HANDLE ASSEMBLY FOR MODEL 116-072A

1. Remove the loose hardware from the assembly pack. You will need a screwdriver and a 5/16" wrench, either a socket as shown in figure 1 or an open end wrench.
2. Assemble the lower handle to the handle brackets as shown in figure 2.
3. Secure the handle with cotter hairpins on both sides. See figure 2.
4. Place the handle panel over the lower handle and fasten with the handle panel screw using a 5/16" wrench. See figure 3.
5. Place the upper handle over the lower handle and line up the holes as shown in figure 4.
6. Insert the curved head bolt from the inside and tighten the knob by hand. See figure 4.
7. Place the throttle control in the handle panel and assemble it with the two throttle screws using a screwdriver. See figure 5.
8. Use the cable clip to fasten the throttle control wire to the lower handle.
9. Check ALL nuts and bolts for correct tightness.

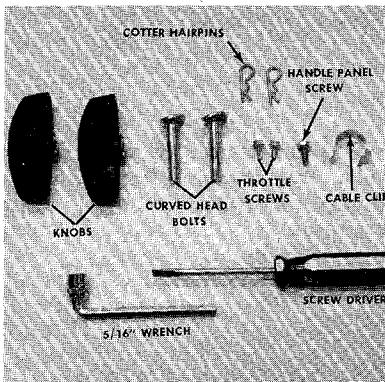

FIGURE 1.

LOOSE HARDWARE AND TOOLS

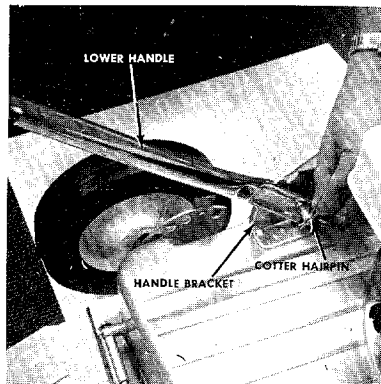

FIGURE 2.

LOWER HANDLE ASSEMBLY

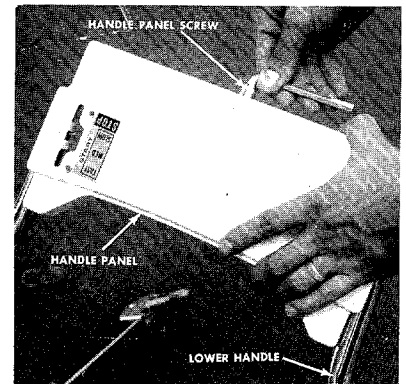

FIGURE 3.

HANDLE PANEL ASSEMBLY

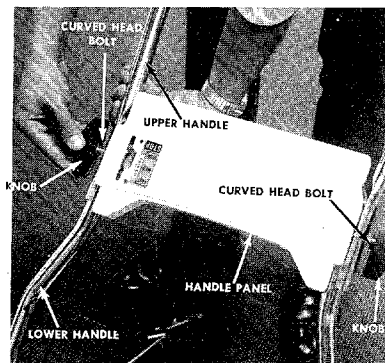

FIGURE 4.
UPPER HANDLE ASSEMBLY

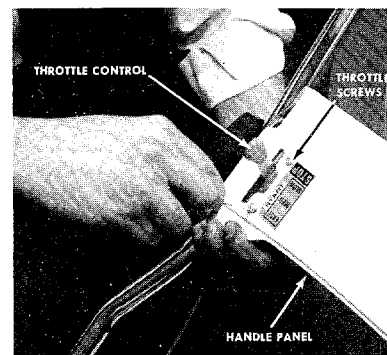

FIGURE 5.
THROTTLE CONTROL ASSEMBLY



It may be necessary to pull open the lower handle. This will insure a tight fit when assembled into handle mount brackets.



CAUTION

Please note that the chute deflector on your mower is in an upright position. It is held in that position by a shipping block. This block is used for shipping purposes only. It must be removed and discarded before your mower is put into operation.

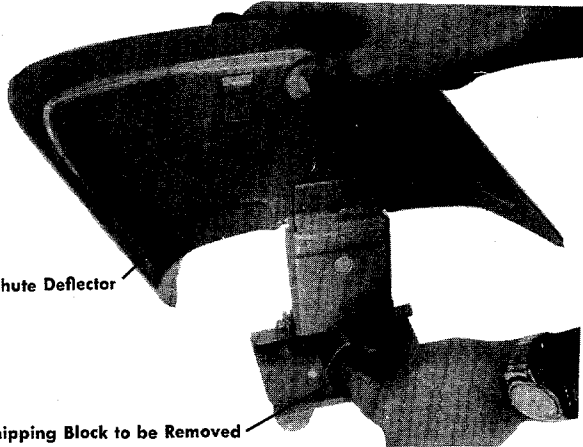

Shipping Block to be Removed
OPERATION

NOTE

For shipping purposes your mower is set with the wheels in a low cutting height position. For best results, raise the cutting position until it is determined which height is best for your lawn. See adjustments.

1. Service engine with gas and oil. See engine manual packed with lawn mower for complete instructions for the care and maintenance of engine. READ DIRECTIONS CAREFULLY.
2. When ready to start engine, place throttle control lever in "START" position and start engine in accordance with instructions in engine manual. After engine starts, move throttle control lever to desired engine speed. The engine is stopped by placing control lever in the "STOP" position.
3. Be sure that lawn is clear of stones, sticks, wire or other objects which could damage lawn mower or engine. For best results and to insure more even grass distribution, do not mow when lawn is excessively wet.

ADJUSTMENTS



CAUTION

Do not at any time make any adjustment to lawn mower without first stopping engine and disconnecting spark plug wire.

CUTTING HEIGHT — (For Model 116-062A)

Adjustment may be made by removing and moving wheel studs to desired position. Cutting heights will be raised as wheel studs are moved to a lower hole and lowered as wheel studs are moved to a higher hole in the deck. All wheel studs must be mounted in a relative position to the deck.

EASY CUTTING HEIGHT — (For Model 116-072A)

An adjusting plate and thumb lever at each wheel position provides cutting height adjustment. Each adjusting plate has five holes. Height of cut will be changed when the thumb lever is moved from one hole to another. Simply depress thumb lever towards wheel and move wheel and lever assembly to desired position. All wheels must be positioned in relative height of cut positions.

THROTTLE

If adjustment becomes necessary, the throttle control wire assembly can be reset as follows:

1. Loosen, but do not remove, screw securing throttle control wire assembly at engine.
2. Move throttle control lever on handle to "FAST" position.
3. Move lever, to which control wire is fastened at engine, to full open position and retighten screw to secure throttle control wire assembly.

LUBRICATION



IMPORTANT

Always stop engine and disconnect spark plug wire before cleaning, lubricating or doing any kind of work on lawn mower.

Wheels — Wheel bearings are of self lubricating Fortiflex. They require no lubrication. If your unit is provided with optional ball bearing wheels, lubricate at least once a season with light oil.

Protective Shield — The pivot points on the protective shield should be lubricated periodically with light oil to prevent any rust or binding up.

Chute Deflector — The torsion spring and pivot point should be lubricated periodically with light oil to prevent any rust or binding up. Deflector should work freely.

Throttle — Periodically lubricate throttle control lever and throttle wire assembly with a few drops of light oil (SAE No. 10 or 20) for ease of operation.

Engine — Follow engine manual for lubrication instructions.

Always disconnect spark plug cable during repairs, refueling or changing oil. Engine oil may be drained through oil filler opening by tilting the mower on its side. Change oil after first 5 hours of operation while engine is warm. Thereafter, change oil every 25 hours of operation while engine is warm.

NOTE: FILL AND DRAIN OIL FROM OIL FILL PLUG.

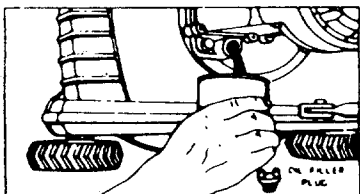

MAINTENANCE

Cutting Blade — The blade may easily be removed for grinding or replacement as follows:

1. Remove bolt and lockwasher holding blade and blade adapter to engine crankshaft.
2. Remove blade and blade adapter from engine crankshaft.
3. Remove two bolts, lockwashers and nuts holding blade to blade adapter (if necessary).

When sharpening blade, follow the original angle of grind as a guide. It is extremely important that each cutting edge receives an equal amount of grinding to prevent an unbalanced blade. An unbalanced blade will cause excessive vibration when rotating at high speeds and may cause damage to the mower.



NOTE

To insure safe operation of your unit, all nuts and bolts must be checked periodically for correct tightness.

Deck — The underside of the mower deck should be cleaned after each period of use as grass clippings, leaves, dirt and other matter will accumulate. This accumulation of grass clippings, etc., is undesirable as it will invite rust and corrosion and may cause an uneven discharge of grass clippings at the next cutting.

The deck may be cleaned by tilting the mower forward or on its side and scraping clean with a suitable tool or by washing with a stream of water from a garden hose.



CAUTION

Do not direct the stream of water at a hot engine, as damage to the engine may result.

Storage — The following steps should be taken to prepare lawn mower for storage:

1. Clean and lubricate mower thoroughly as described in the preceding instructions.
2. Refer to engine manual for correct engine storage instructions.
3. Coat mower's cutting blade with chassis grease to prevent rusting.
4. Place blocks under deck to raise tires clear of floor.
5. Store mower in a dry, clean area.

HANDLE STORAGE

This model is so equipped to provide easy fold away handle storage.

1. Loosen the two plastic knobs on each side, center of handle.
2. Pull inward on the bottom of each side of the lower handle and push forward.
3. Fold the upper handle back and down as shown.

To Take the Handle out of Storage Position.

1. Lift the upper handle up and towards the rear as shown.
2. Pull the handle back until it **Locks** into the operator's position.
3. Tighten the two plastic knobs securely.
4. Reassemble the clutch rod.

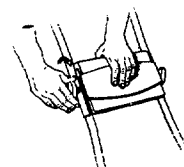
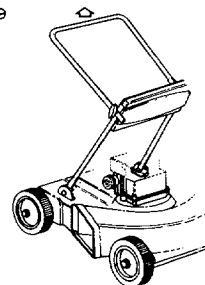
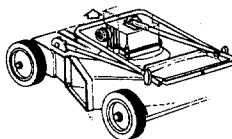

USING YOUR ROTARY MOWER

For best results, do not cut wet grass because it tends to stick to underside of the mower thus preventing proper discharge of grass clippings. If wet grass must be cut, reduce walking speed to help distribute the clippings more effectively.

New grass should be treated as wet grass, otherwise a

normal walking speed is about the right pace for efficient mowing. The best mowing pattern is one that allows the clippings to discharge towards the uncut part of the lawn. This permits recutting of the clippings to further pulverize them. When cutting high weeds, discharge towards cut portion, then recut at right angles to first direction.

Lawn should be cut in the fall as long as there is growth.



NOTE

The manufacturer DOES NOT recommend the use of any accessory on this rotary mower other than those manufactured by MTD Products Inc.

GRASS CATCHER Model No. 196-003A is available as optional equipment for the mowers shown in this manual.



WARNING

1. The mower should not be operated without the entire grass catcher or chute deflector in place.
2. The mower should not be operated without the protective shield on the rear of the deck in place.



NOTE:

Under normal usage bag material is subject to wear and should be checked periodically. Be sure any replacement bag complies with the mower manufacturer's recommendations.

For replacement bags, use only factory authorized replacement bag No. 764-0119.



IMPORTANT

After striking a foreign object, stop the engine, remove wire from spark plug. Thoroughly inspect the mower for any damage, and repair the damage before restarting and operating the mower.

116-062A
116-072A

IF YOU WRITE TO US ABOUT THIS ARTICLE
 OR IF YOU ORDER REPLACEMENT PARTS AL-
 WAYS MENTION THIS MODEL & SERIAL NO
 MODEL

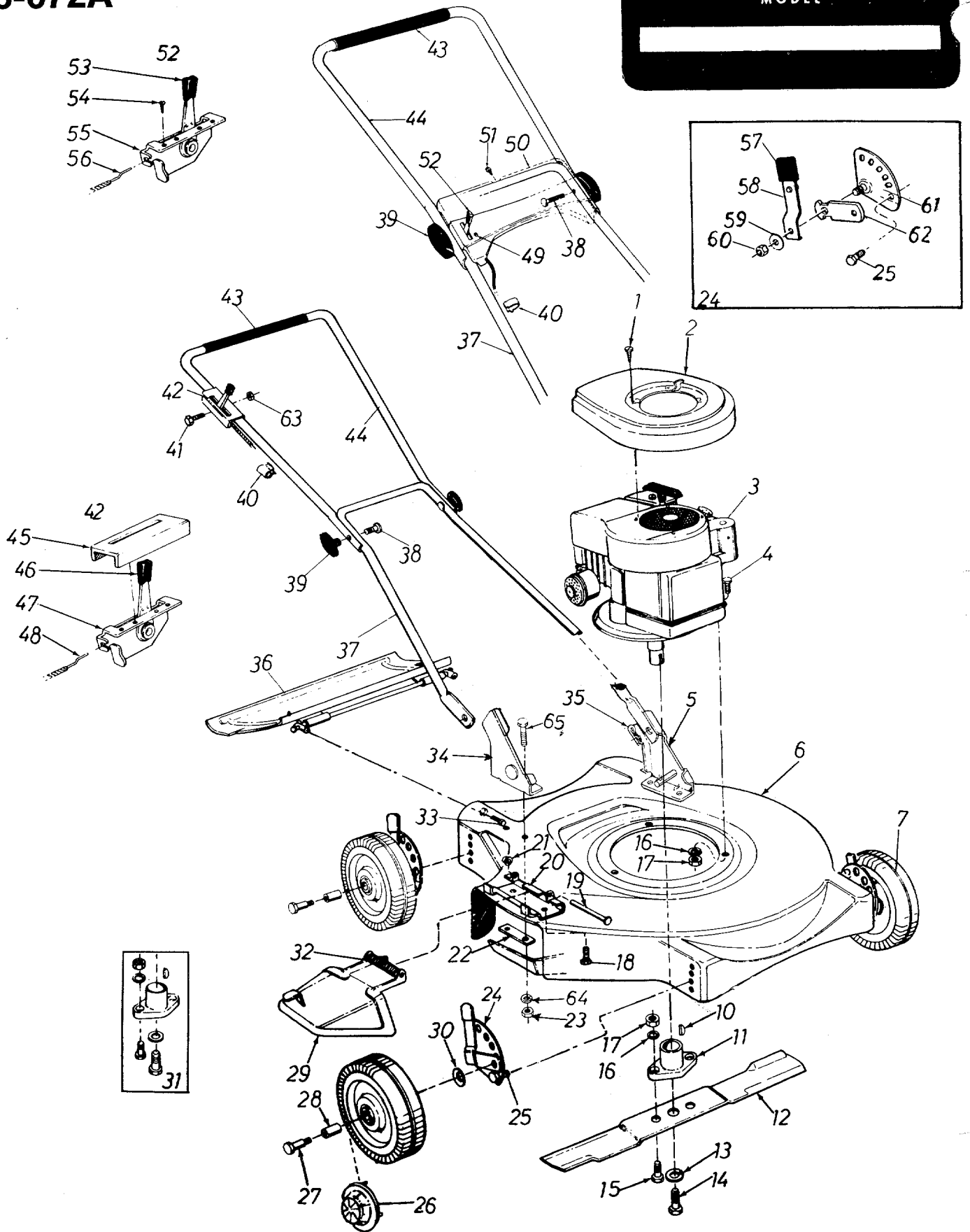

PARTS LIST FOR MODELS 116-062A AND 116-072A

REF. NO.	PART NO.	COLOR CODE	DESCRIPTION	NEW PART	REF. NO.	PART NO.	COLOR CODE	DESCRIPTION	NEW PART
1	710-0227		Hex Wash. Hd. AB Tapp Scr. #8 x .38" Lg. (116-072A)		38	710-0405		Curved Carriage Bolt 5/16-18 x 1.75" Lg.	
2	10612	—463	Shroud (116-072A)		39	09966		Knob—Handle	
3	—		Engine		40	746-0128		Cable Clip	
4	710-0158		Hex Scr. 5/16-24 x 1.25" Lg.*		41	710-0606		Hex Scr. 1/4-20 x 1.50" Lg.*	
5	12575		Handle Mount Bracket—L.H.	N	42	746-0234		Throttle Control Ass'y. Comp. (116-062A)	
6	12329	—463	20" Deck Ass'y. Complete	N	43	718-0143		Grip	
7	09392-502		Wheel Ass'y. Comp.—7 x 1.50		44	11204		Upper Handle (116-062A)	
10	714-0365		#6 Hi-Pro-Key 5/32" x 5/8" Dia.		45	10011		Upper Handle (116-072A)	
11	10769		Blade Adapter Kit		46	731-0344		Plastic Label (116-062A)	N
12	742-0123		20" Blade		47	07470		Throttle Control Knob (116-062A)	
13	736-0217		L-Wash. 3/8" Scr. Heavy Duty		48	11598		Throttle Control Ass'y. (116-062A)	
14	710-0459		Hex Scr. 3/8-24 x 1.50" Lg. H.T.		49	746-0174		Conduit and Wire (116-062A)	
15	710-0117		Hex Scr. 5/16-24 x 1.00" Lg. H.T.		50	710-0227		Hex Hd. Wash. Hd. AB-Tapp Scr. #8 x .38" (116-072A)	
16	736-0119		L-Wash. 5/16" Scr.*		51	11606	—463	Handle Panel (116-072A)	
17	712-0123		Hex Nut 5/16-24 Thd.*		52	710-0224		Hex AB Tapp. Scr. #10 x .50" Lg.	
18	710-0289		Hex Scr. 1/4-20 x .50" Lg.*		53	11610		Throttle Control Ass'y. Comp. (116-072A)	
19	711-0555		Pivot Pin		54	07470		Throttle Control—Knob (116-072A)	
20	11130	—463	Adapter Plate		55	710-0227		Hex Wash. Hd. AB-Tapp. Scr. #8 x .38" (116-072A)	
21	726-0106		Push Nut 1/4" Rod		56	11598		Throttle Control Ass'y. (116-072A)	
22	08405		Reinforcement Plate		57	746-0232		Conduit and Wire (116-072A)	
23	712-0107		Hex Center L-Nut 1/4-20 Thd.		58	07520		Knob—Height Adjuster (116-072A)	
24	10950		Height Adjuster Ass'y. Comp.—L.H. (116-072A)		59	10949		Spring Lever Ass'y. with Knob (116-072A)	
	10951		Height Adjuster Ass'y. Comp.—R.H. (116-072A)		60	736-0219		Belleville Wash. .400" I.D. x 1.13" O.D. (116-072A)	
25	710-0209		Hex Sems Scr. 3/8-16 x .62" x Lg. (116-072A)		61	712-0116		Hex Ins. L-Nut 3/8"-24 Thd. (116-072A)	
26	731-0124		Hub Cap (116-072A)		62	10934		Index Plate Ass'y.—R.H. (116-072A)	
27	738-0102		Axle Bolt (116-072A)			10935		Index Plate Ass'y.—L.H. (116-072A)	
28	738-0213		Axle Bolt (116-072A)		63	10937		Pivot Bar (116-072A)	
29	07006		Fortiflex Bearing	N	64	712-0107		Hex Center L-Nut 1/4-20 Thd. (116-062A)	
30	11681	—463	Chute Deflector Ass'y.		65	736-0329		L-Wash. 1/4" Scr.*	
31	736-0105		Belleville Wash. .400" I.D. x .88" O.D. x .060			710-0252		Hex Scr. 1/4-20 x .75" Lg.*	
32	10769		Blade Adapter Kit						
33	732-0253		Torsion Spring						
34	710-0567		Hex Scr. 1/4-28 x .62" Lg.*						
35	12576		Handle Mount Brkt.—R.H.						
36	714-0104		Internal Cotter Pin 5/16" Dia.						
37	11190	—463	Rear Protective Shield Ass'y. Complete						
	749-0104		Lower Handle (116-062A)						
	10009		Lower Handle (116-072A)						

*For faster service obtain standard nuts, bolts and washers locally. If these items cannot be obtained locally, order by part number and size as shown on parts list.

(463—Top Flite Red) When ordering parts if color or finish is important, use color code shown at left. (e.g. Top Flite Red Finish—11907 (463))

NOTE: This instruction manual covers various models and all accessories shown do not necessarily apply to your model mower.

The engine is not under warranty by the mower manufacturer. If repairs or service is needed on the engine, please contact your nearest authorized engine service outlet. Check the "Yellow Pages" of your telephone book under "Engines—Gasoline."

Find us fast in the



PARTS INFORMATION

POWER EQUIPMENT PARTS AND SERVICE

Parts and service for all MTD manufactured power equipment are available through the authorized service firms listed below. All orders should specify the model number of your unit, parts numbers, description of parts and the quantity of each part required.

ALABAMA	BIRMINGHAM	
	Auto Electric & Carburetor Co.	2625 4th Ave. S. 35233
ARKANSAS	NORTH LITTLE ROCK	
	Sutton's Lawn Mower Shop	Rt. 4, Box 368 72117
	FORT SMITH	
	Mity Mite Motors, Inc.	2515 Towson Ave. 72901
CALIFORNIA	SAN BERNARDINO	
	Lawn Mower Supply Co.	25608 E. Baseline 92410
	SAN FRANCISCO	
	J.W. Jewett Co.	981 Folsom St. 94107
	SACRAMENTO	
	Luttig & Severson	2030 28th St. 95818
COLORADO	DENVER	
	South Denver Lawn Equip.	527 West Evans 80223
CONNECTICUT	SUFFIELD	
	The Jones & Ramsey Co.	850 Thompsonville Rd. 06078
FLORIDA	JACKSONVILLE	
	Radco Distributors	2403 Market St. 32206
	CORAL GABLES	
	Moz-All of Florida, Inc.	365 Greco Ave. 33146
GEORGIA	EAST POINT	
	East Point Cycle & Key	2834 Church St. 30344
ILLINOIS	LYONS	
	Keen Edge Co.	8615 Ogden Ave. 60534
INDIANA	ELKHART	
	Parts & Sales Inc.	2101 Industrial Pkwy. ...46514
	CORYDON	
	Brown Equip. Dist., Inc.	110 Beech St.47112
IOWA	DUBUQUE	
	Power Lawn & Garden Equip.	2551 J.F. Kennedy 52001
KANSAS	WICHITA	
	Hixon, Inc.	3030 Mascot 67204
LOUISIANA	NEW ORLEANS	
	Suhren Engine Co.	8330 Earhart Blvd. 70118
MARYLAND	TAKOMA PARK	
	Center Supply Co.	6867 New Hampshire Ave. 20012
MASSACHUSETTS	SPRINGFIELD	
	Morton B. Collins Co.	300 Birnie Ave. 01107
MICHIGAN	MOUNT CLEMENS	
	Power Equipment Dist.	36463 South Gratiot... 48043
	LANSING	
	Lorenz Service Co.	2500 S. Pennsylvania.. 48900
MINNESOTA	MINNETONKA	
	Hance Distributing Inc.	11212 Wayzata Blvd. ..55343
MISSISSIPPI	BILOXI	
	Biloxi Sales & Service, Inc.	506 Caillavet St. 39533
MISSOURI	KANSAS CITY	
	Automotive Equip. Service	3117 Holmes St. 64109
	ST. LOUIS	
	Henzler, Inc.	2015 Lemay Ferry Rd. 63125
NEBRASKA	OMAHA	
	R.P.W., Inc.	7402 "L" St. 68127

BRIGGS & STRATTON, TECUMSEH AND PEERLESS PARTS AND SERVICE

Briggs & Stratton, Tecumseh and Peerless parts and service should be handled by your nearest authorized engine service firm. Check the yellow pages of your telephone directory under the listing *Engines Gasoline*, Briggs & Stratton or Tecumseh Lauson

NEW YORK	CARTHAGE	
	Gamble Dist., Inc.	West End Ave. 13619
	SYRACUSE	
	Kimber's, Inc.	115 N. Geddes St. 13204
	ROCHESTER	
	Henry W. O'Neil & Associates	410 N. Goodman St. ... 14609
NORTH CAROLINA	GREENSBORO	
	Dixie Sales Company	327 Battleground Ave.. 27402
	GOLDSBORO	
	Smith Hardware Co.	515 N. George St. 27530
OHIO	WADSWORTH	
	National Central	687 Seville Rd. 44281
	CLEVELAND	
	Bleckrie, Inc.	7900 Lorain Ave. 44102
	CARROL	
	Stebe's Mid-State Mower Supply	Box 366 43112
	WILLARD	
	Sunshine Wholesale Tire Outlet	Route 224 44890
	MANSFIELD	
	McClure Lawn & Garden Supply	1114 Lexington Ave. . 44903
OKLAHOMA	MUSKOGEE	
	Victory Motors, Inc.	605 S. Cherokee 74401
	ADA	
	Ada Auto Supply	301 E. 12th St. 74820
OREGON	PORTLAND	
	Kenton Supply Co.	8216 N. Denver Ave. . 97217
PENNSYLVANIA	LANCASTER	
	Raub Supply Co.	James & Mulberry Sts...17604
	PITTSBURGH	
	Bluemont Co.	11125 Frankstown Rd.. 15231
TENNESSEE	KNOXVILLE	
	Master Repair Service	2423 Broadway, N.E. ...37917
	MEMPHIS	
	Memphis Cycle & Supply Co.	421 Monroe Ave. 38103
	American Sales & Service, Inc.	1922 Lynnbrook 38117
TEXAS	DALLAS	
	Marr Brothers, Inc.	423 E. Jefferson 75203
	HOUSTON	
	Bullard Supply Co.	2409 Commerce St. 77003
	SAN ANTONIO	
	Catto & Putty, Inc.	P.O. Box 240878206
	FORT WORTH	
	Woodson Sales Corp.	1702 N. Sylvania 76111
UTAH	SALT LAKE CITY	
	A-1 Engine & Mower Co.	437 E. 9th St.84111
VERMONT	BURLINGTON	
	Vermont Appliance Co.	44 Lakeside Ave.05401
VIRGINIA	RICHMOND	
	RBI Corp.	963 Myers St. 23260
WASHINGTON	SEATTLE	
	Bailey's Rebuild, Inc.	1325 E. Madison St. ...98102
WEST VIRGINIA	CHARLESTON	
	Young's, Inc.	233 Virginia St., E. ... 25301
WISCONSIN	APPLETON	
	Automotive Supply Co.	123 S. Linwood Ave. ...54911

WARRANTY PARTS AND SERVICE POLICY

The purpose of warranty is to protect the customer from defects in workmanship and materials, defects which are NOT detected at the time of manufacture, It does not provide for the unlimited and unrestricted replacement of parts. Use and maintenance are the responsibility of the customer. The manufacturer cannot assume responsibility for conditions over which it has no control. Simply put, if it's the manufacturer's fault, it's the manufacturer's responsibility; if it's the customer's fault, it's the customer's responsibility.

CLAIMS AGAINST THE MANUFACTURER'S WARRANTY INCLUDES

1. Replacement of Missing Parts on new equipment.
2. Replacement of Defective Parts within the warranty period.
3. Repair of Defects within the warranty period.

All claims MUST be substantiated with the following information:

1. Model Number of unit involved.
2. Date unit was purchased or first put into service.
3. Date of failure.
4. Nature of failure.