

Owner's Operating Service Instruction Manual

10¢

Model No.
114-100A

- ASSEMBLY
- OPERATION
- REPAIR PARTS

18" ROTARY MOWER

WARRANTY

For one year from date of purchase, MTD Products Inc will replace for the original purchaser, free of charge, F.O.B. factory or authorized service firm, any part or parts found to be defective in material or workmanship. All transportation charges on parts submitted for replacement under this warranty must be paid by the purchaser. This warranty does not include replacement of parts which become inoperative through misuse, excessive use, accident, neglect, improper maintenance or alterations by unauthorized persons. This warranty does not include the engine, motor, battery, battery charger or any component parts thereof. For service on these units, refer to the applicable manufacturer's warranty.

The above warranty will apply only to the original owner and will be effective only if the warranty card has been properly processed. It will not apply where the unit has been used commercially.

Warranty service is available through your local authorized service dealer or distributor. **UNDER NO CIRCUMSTANCES WILL THE RETURN OF A COMPLETE UNIT BE ACCEPTED BY THE FACTORY UNLESS PRIOR WRITTEN PERMISSION HAS BEEN EXTENDED.**

I M P O R T A N T

SAFE OPERATION PRACTICES FOR WALK-BEHIND MOWERS

TRAINING

1. Read the Operating and Service Instruction Manual carefully. Be thoroughly familiar with the controls and the proper use of the equipment.
2. Never allow children to operate a power mower.
3. Keep the area of operation clear of all persons, particularly small children and pets.

PREPARATION

1. Thoroughly inspect the area where the equipment is to be used and remove all stones, sticks, wire, bones and other foreign objects.
2. Do not operate equipment when barefoot or wearing open sandals. Always wear substantial footwear.
3. Check the fuel before starting the engine. Do not fill the gasoline tank indoors, when the engine is running, or while the engine is still hot. Wipe off any spilled gasoline before starting the engine.
4. Disengage the self-propelled mechanism or drive clutch on units so equipped before starting the engine (motor).
5. Never attempt to make a wheel adjustment while the engine (motor) is running.
6. Mow only in daylight or in good artificial light.
7. Never operate the equipment in wet grass. Always be sure of your footing; keep a firm hold on the handle and walk, never run.

OPERATION

1. Do not change the engine governor settings or overspeed the engine.
2. Do not put hands or feet near or under rotating parts. Keep clear of the discharge opening at all times.
3. Stop the blade(s) when crossing gravel drive, walks or roads.
4. After striking a foreign object, stop the engine (motor), remove the wire from spark plug, thoroughly inspect the mower for any damage, and repair the damage before restarting and operating the mower.

5. If the equipment should start to vibrate abnormally, stop the engine (motor) and check immediately for the cause. Vibration is generally a warning of trouble.
6. Stop the engine (motor) whenever you leave the equipment, before cleaning the mower housing, and when making any repairs or inspections.
7. When cleaning, repairing or inspecting, make certain the blade and all moving parts have stopped. Disconnect the spark plug wire, and keep the wire away from the plug to prevent accidental starting.
8. Do not run the engine indoors.
9. Shut the engine (motor) off and wait until the blade comes to a complete stop before removing the grass catcher or unclogging chute.
10. Mow across the face of slopes, never up-and-down. Exercise extreme caution when changing direction on slopes. Do not mow excessively steep slopes.
11. Always disconnect electric mowers (line operated) before cleaning, repairing or adjusting.
12. Never operate mower without proper guards, plates or other safety protective devices in place.
13. Keep washout ports and other mower-housing service openings closed when mowing.

MAINTENANCE AND STORAGE

1. Check the blade and engine mounting bolts at frequent intervals for proper tightness.
2. Keep all nuts, bolts, and screws tight to be sure the equipment is in safe working condition.
3. Never store the equipment with gasoline in the tank inside of a building where fumes may reach an open flame or spark. Allow the engine to cool before storing in any enclosure.
4. To reduce fire hazard, keep the engine free of grass, leaves, or excessive grease.
5. Check the grass catcher bag frequently for wear or deterioration. Replace with new bag for safety protection.

CAUTION

Please note that the chute deflector on your mower is in an upright position. It is held in that position by a shipping block. This block is used for shipping purposes only. It must be removed and discarded before your mower is put into operation.

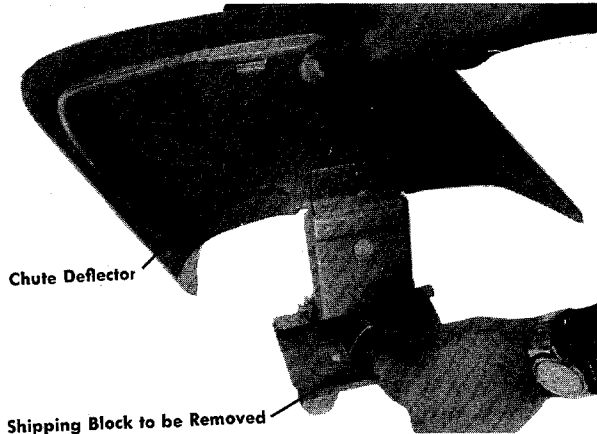

HANDLE ASSEMBLY

Your new mower is shipped completely assembled with the exception of the handle and throttle control assembly.

1. Remove lawn mower and all parts from carton. Make certain that all loose parts and literature are removed from carton before carton is discarded.
2. Extend throttle control assembly, which is attached to engine, to rear of mower and place on floor.
CAUTION: Do not bend or kink control wire.
3. Assemble upper handle to lower handle using four each screws and locknuts provided in parts bag.
4. Assemble complete handle assembly to mower. Holes at bottom of lower handle are to be fitted over studs located in handle mounting brackets.
5. Position throttle control assembly on right hand side of upper handle so that holes in control assembly and handle are in line. Secure in place with screw and locknut found in parts bag. Secure throttle wire to lower right handle tube with clips in parts bag.
6. Place the plastic control cover over the throttle control and secure with two self-tapping screws.
7. Check all nuts and bolts for correct tightness.

NOTE

It may be necessary to bend the ends of the lower handle inward slightly to assure a snug fit against the deck mounting area.

ASSEMBLY FOR OPTIONAL HANDLE

1. Remove the loose hardware from the assembly pack. You will need a screwdriver and a 5/16" wrench, either a socket as shown in figure 2 or an open end wrench.
2. Assemble the lower handle to the handle brackets as shown in figure 3.
3. Secure the handle with cotter hairpins on both sides. See figure 3.
4. Place the handle panel over the lower handle and fasten with the handle panel screw using a 5/16" wrench. See figure 4.
5. Place the upper handle over the lower handle and line up the holes as shown in figure 5.
6. Insert the curved head bolt from the inside and tighten the knob by hand. See figure 5.
7. Place the throttle control in the handle panel and assemble it with the two throttle screws using a screwdriver. See figure 6.
8. Use the cable clip to fasten the throttle control wire to the lower handle.

NOTE

It may be necessary to spread the ends of the lower handle outward slightly to assure a snug fit against the bracket mounting area.

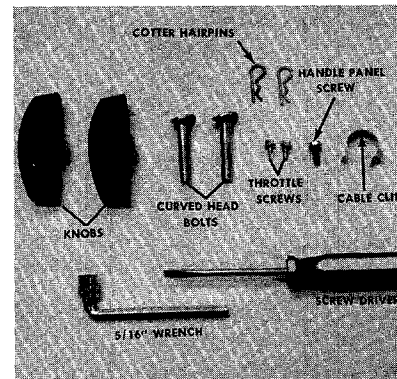

FIGURE 2. LOOSE HARDWARE AND TOOLS

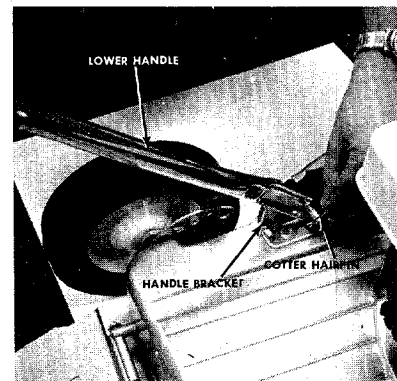

FIGURE 3. LOWER HANDLE ASSEMBLY

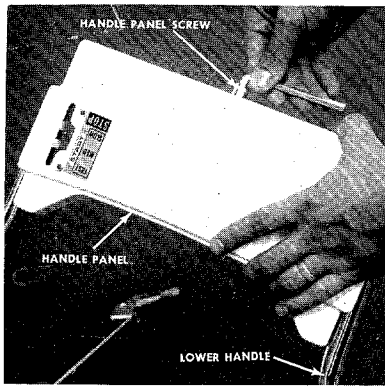

FIGURE 4. HANDLE PANEL ASSEMBLY

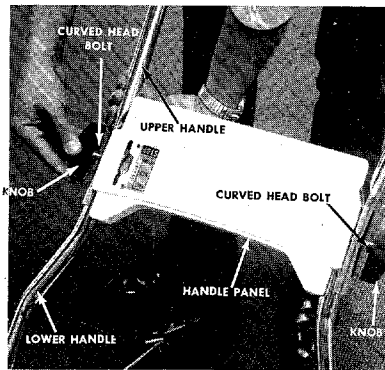

FIGURE 5. UPPER HANDLE ASSEMBLY

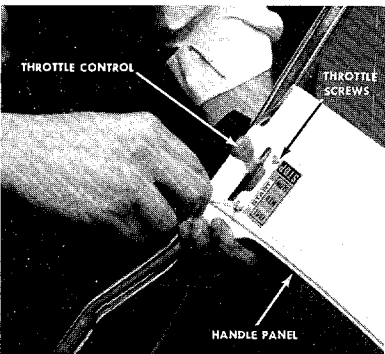

FIGURE 6. THROTTLE CONTROL ASSEMBLY

OPERATION

NOTE

For shipping purposes your mower is set with the wheels in a low cutting height position. For best results, raise the cutting position until it is determined which height is best for your lawn. See adjustments.

1. Service engine with gas and oil. See engine manual packed with lawn mower for complete instructions for the care and maintenance of engine. READ DIRECTIONS CAREFULLY.

2. When ready to start engine, place throttle control lever in "START" position and start engine in accordance with instructions in engine manual. After engine starts, move throttle control lever to desired engine speed. The engine is stopped by placing control lever in the "STOP" position.
3. Be sure that lawn is clear of stones, sticks, wire or other objects which could damage lawn mower or engine. For best results and to insure more even grass distribution, do not mow when lawn is excessively wet.
4. Check all nuts and bolts for correct tightness.

ADJUSTMENTS

CAUTION

Do not at any time make any adjustment to lawn mower without first stopping engine and disconnecting spark plug wire.

OPTIONAL CUTTING HEIGHT

An adjusting plate and thumb lever at each wheel position provides cutting height adjustment. Each adjusting plate has five holes. Height of cut will be changed when the thumb lever is moved from one hole to another. Simply depress thumb lever towards wheel and move wheel and lever assembly to desired position. All wheels must be positioned in relative height of cut positions.

STANDARD CUTTING HEIGHT

Adjustment may be made by removing and moving wheel studs to desired position. Cutting heights will be raised as wheel studs are moved to a lower hole and lowered as wheel studs are moved to a higher hole in the deck. All wheel studs must be mounted in a relative position to the deck.

THROTTLE

If adjustment becomes necessary, the throttle control wire assembly can be reset as follows:

1. Loosen, but do not remove, screw securing throttle control wire assembly at engine.
2. Move throttle control lever on handle to "FAST" position.
3. Move lever, to which control wire is fastened at engine, to full open position and retighten screw to secure throttle control wire assembly.

LUBRICATION

IMPORTANT: Always stop engine and disconnect spark plug wire before cleaning, lubricating or doing any kind of work on lawn mower.

Protective Shield — The pivot points on the protective shield should be lubricated periodically with oil to prevent any rust or binding up.

Chute Deflector — The torsion spring and pivot point should be lubricated periodically with oil to prevent any rust or binding up. Deflector must work freely.

Wheels—Wheel bearings are of self-lubricating Fortiflex. They require no lubrication. If your unit is provided with optional ball bearing wheels, lubricate at least once a season with light oil.

Throttle — Periodically lubricate throttle control lever and throttle wire assembly with a few drops of light oil (SAE No. 10 or 20) for ease of operation.

Engine — Follow engine manual for lubrication instructions.

NOTE: FILL AND DRAIN OIL FROM OIL FILL PLUG.

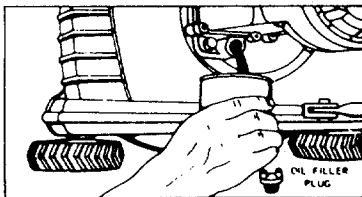

Always disconnect spark plug cable during repairs, refueling or changing oil. Engine oil may be drained through oil filler opening by tilting the mower on its side. Change oil after first 5 hours of operation while engine is warm. Thereafter, change oil every 25 hours of operation while engine is warm.

MAINTENANCE

Cutting Blade — The blade may easily be removed for grinding or replacement as follows:

1. Remove bolt and lockwasher holding blade and blade adapter to engine crankshaft.
2. Remove blade and blade adapter from engine crankshaft.
3. Remove two bolts, lockwashers and nuts holding blade to blade adapter (if necessary).

When sharpening blade, follow the original angle of grind as a guide. It is extremely important that each cutting edge receives an equal amount of grinding to prevent an unbalanced blade. An unbalanced blade will cause excessive vibration when rotating at high speeds and may cause damage to the mower. Upon reassembly, make certain all parts are assembled properly and tightened securely.

NOTE

To insure safe operation of your unit, ALL nuts and bolts must be checked periodically for correct tightness.

Deck — The underside of the mower deck should be cleaned after each period of use as grass clippings, leaves, dirt and other matter will accumulate. This accumulation of grass clippings, etc., is undesirable as it will invite corrosion and may cause an uneven discharge of grass clippings at the next cutting.

The deck may be cleaned by tilting the mower forward or on its side and scraping clean with a suitable tool or by washing with a stream of water from a garden hose.

CAUTION

Do not direct the stream of water at a hot engine, as damage to the engine may result.

Storage — The following steps should be taken to prepare lawn mower for storage:

1. Clean and lubricate mower thoroughly as described in the preceding instructions.
2. Refer to engine manual for correct engine storage instructions.
3. Coat mower's cutting blade with chassis grease to prevent rusting.
4. Place blocks under deck to raise tires clear of floor.
5. Store mower in a dry, clean area.

USING YOUR MOWER

For best results, do not cut wet grass because it tends to stick to underside of the mower thus preventing proper discharge of grass clippings. If wet grass must be cut, reduce walking speed to help distribute the clippings more effectively.

New grass should be treated as wet grass, otherwise a normal walking speed is about the right pace for efficient mowing. The best mowing pattern is one that allows the clippings to discharge towards the uncut part of the lawn. This permits recutting of the clippings to further pulverize them. When cutting high weeds, discharge towards cut portion, then recut at right angles to first direction.

Lawn should be cut in the fall as long as there is growth.

NOTE

The manufacturer DOES NOT recommend the use of any accessory on this rotary mower other than those manufactured by MTD Products Inc.

GRASS CATCHER Model No. 194-003A is available as optional equipment for the mowers shown in this manual.

WARNING:

1. The mower should not be operated without the entire grass catcher or chute deflector in place.
2. The mower should not be operated without the protective shield on the rear of the deck in place.

NOTE:

Under normal usage bag material is subject to wear and should be checked periodically. Be sure any replacement bag complies with the mower manufacturer's recommendations.

For replacement bags, use only factory authorized replacement bag No. 764-119.

★ IMPORTANT

After striking a foreign object, stop the engine (motor), remove wire from spark plug. Thoroughly inspect the mower for any damage, and repair the damage before restarting and operating the mower.

114-100A

IF YOU WRITE TO US ABOUT THIS ARTICLE
OR IF YOU ORDER REPLACEMENT PARTS AL-
WAYS MENTION THIS MODEL & SERIAL NO
MODEL

OPTIONAL HANDLE

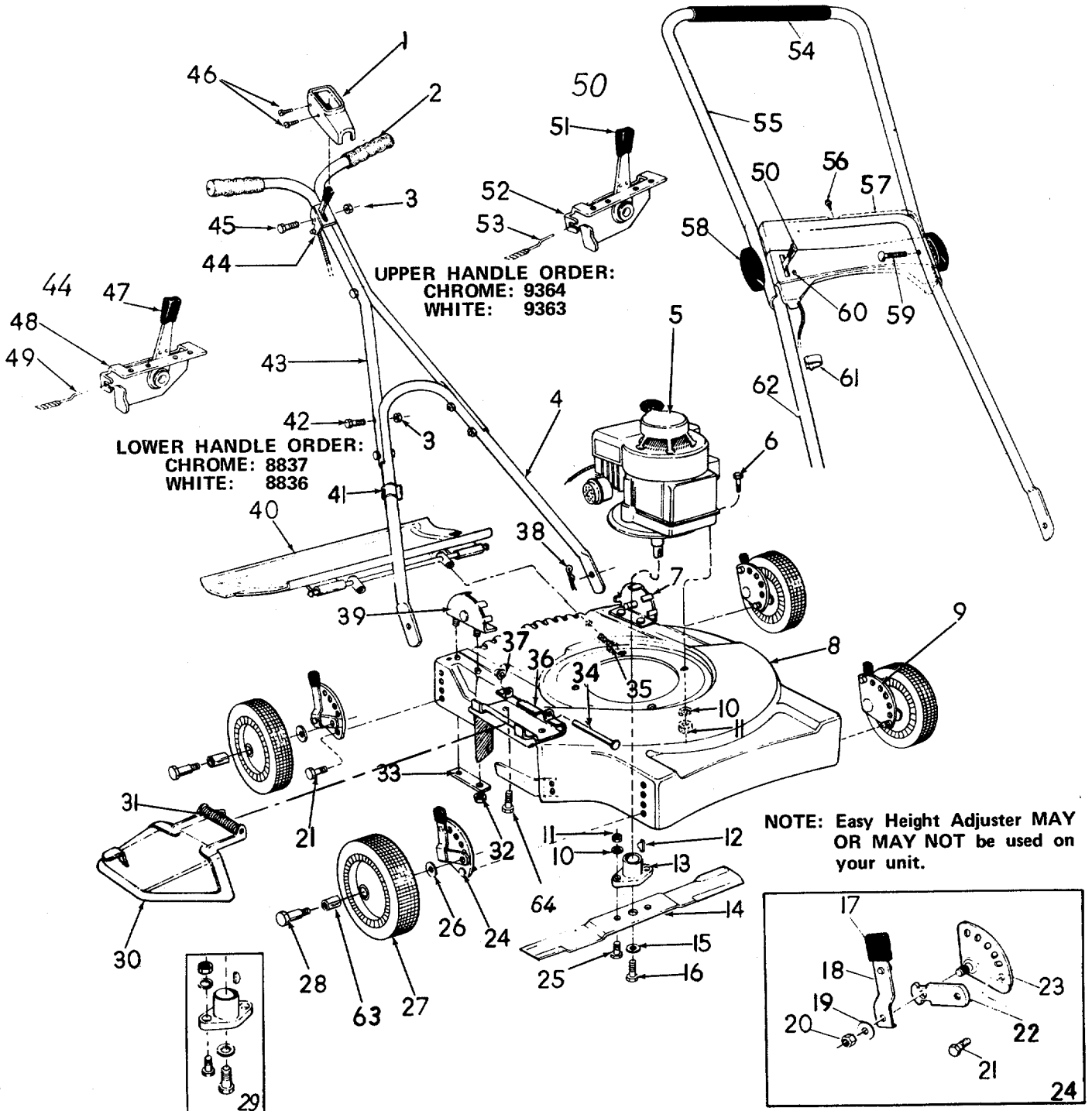

PARTS LIST FOR MOWER MODEL 114-100A

REF. NO.	PART NO.	COLOR CODE	DESCRIPTION	NEW PART	REF. NO.	PART NO.	COLOR CODE	DESCRIPTION	NEW PART
1	11608		Throttle Control—Cover		35	710-567		Hex Scr. 1/4-28 x .62" Lg.	
2	7071		Grips		36	11130—458		Adapter Plate	
3	712-107		Hex Center Locknut 1/4-20 Thd.*		37	726-106		Push-on Flange Palnut	
4	8837		Lower Handle		38	714-104		Internal Cotter Pin 5/16 Dia.	
5	—		Engine		39	8388		Handle Bracket Ass'y.—R.H.	
6	710-158		Hex Scr. 5/16-24 x 1.25" Lg.*		40	11190—458		Rear Protective Shield Ass'y.—Comp.	
7	8389		Handle Bracket Assembly—L.H.		41	746-145		Cable Clip 3/4" Tubing	
8	11404—458		Deck Assembly		42	710-606		Hex Scr. 1/4-20 x 1.50" Lg.*	
9	10950		Adj. Wheel Ass'y.—L.H. Comp.†		43	9364		Upper Handle	
10	736-119		Spring Lockwasher 5/16" Scr.*		44	11597		Throttle Control Complete	
11	712-123		Hex Nut 5/16-24 Thd.*		45	710-606		Hex Scr. 1/4-20 x 1.50" Lg.*	
12	714-365		#6 Hi-Pro-Key 5/32 x 5/8 Dia.		46	710-224		Hex "AB"—Tapp Scr. No. 10 x .50" Lg.	
13	10769		Blade Adapter Kit		47	7470		Throttle Control—Knob—Red	
14	742-121		Blade—18 inch		48	11598		Throttle Control Ass'y.	
15	736-217		Spring Lockwasher 3/8 Scr.—H.D.		49	746-229		Conduit and Wire	
16	710-459		Hex Scr. 3/8-24 x 1.50" Lg. H.T.		50	11610		Throttle Control Comp. (Optional Handle)**	
17	7520		Knob†		51	7470		Throttle Control—Knob—Red**	
18	10949		Spring Lever Ass'y. with Knob†		52	11600		Throttle Control—Brkt. Ass'y.*	
19	736-219		Belleville Washer .400 I.D. x 1.13 O.D.†		53	746-232		Conduit and Wire**	
20	712-116		Elastic Stopnut†		54	718-143		Grip**	
21	710-209		Sems Hex Hd. Cap Scr. 3/8-16 x 5/8"†		55	10011		Upper Handle**	
22	10937		Pivot Bar†		56	710-473		Truss Hd. Mach. Scr. No. 10-24 x .50" Lg.**	
23	10934		Index Plate Ass'y.—R.H.†		57	11606		Handle Panel**	
	10935		Index Plate Ass'y.—L.H.†		58	9966		Hand Knob**	
24	10951		Adj. Wheel Ass'y.—R.H. Comp.†		59	710-405		Curved Head Bolt**	
25	710-117		Hex Scr. 5/16-24 x 1" Lg.—H.T.		60	710-407		Slotted Hex Hd. Self Extr. Scr. No. 8-32 x .50" Lg.**	
26	736-105		Belleville Washer .400" I.D. x .88" O.D. x .060		61	746-128		Cable Clip (Folding Handle)**	
27	9392-502		Wheel Assembly—Complete		62	10970		Lower Handle**	
28	738-213		Axle Bolt		63	7006		Fortiflex Bearing	
	738-102		Axle Bolt (with easy Height Adj.)†		64	710-289		Hex Scr. 1/4-20 x .50"	
29	10769		Blade Adapter Kit			11681—458		Chute Deflector Ass'y.—Comp. (Includes Ref. Nos. 30, 31, 34, 36 and 37)	
30	11148—458		Chute Deflector Ass'y.						
31	732-253		Torsion Spring						
32	712-107		Hex Center Locknut—1/4-20 Thd.*						
33	8405		Reinforcement Plate						
34	711-555		Pivot Pin						

*For faster service, obtain standard nuts, bolts and washers locally. If these items cannot be obtained locally, order by part number and size as shown on the parts list.

**Part of Throttle Control Complete and Optional Handle.

†Optional Easy Height Adjuster Parts.

458 Arctic Blue

When ordering parts, if color or finish is important, use the appropriate color code shown above (e.g. Arctic Blue Finish, 11404 (458)).

NOTE: The engine is not under warranty by the mower manufacturer... If repairs or service is needed on the engine, please contact your nearest authorized engine service outlet.

Check the "Yellow Pages" of your telephone book under "Engines - Gasoline."

Find us fast in the



PARTS INFORMATION

DEFECTIVE OR MISSING PARTS must be reported to the factory immediately. Such claims must include your model number and date of purchase.

POWER EQUIPMENT PARTS AND SERVICE

Parts and service for all MTD manufactured power equipment are available through the authorized service firms listed below. All orders should specify the model number of your unit, parts numbers, description of parts and the quantity of each part required.

A 1 Engine & Mower Co.
327 East 9th Street
Salt Lake City, Utah 84102

American Electric Ignition Co.
124 N. W. 8th Street
Oklahoma City, Oklahoma 73102

Auto Electric & Carburetor Co.
2525 4th Avenue, S.
P. O. Box 1948
Birmingham, Alabama 35233

Automotive Equipment Service Co.
3117 Holmes Street
Kansas City, Missouri 64109

Bailey's Rebuild Inc.
1325 E. Madison Street
Seattle Washington 98102

Bleckie, Inc.
7900 Lorain Avenue
Cleveland, Ohio 44102

Brown Equipment Distributor Inc.
110 Beech Street
Corydon, Indiana 47112

Bullard Supply
2409 Commerce Street
Houston, Texas 77003

Carl A. Anderson Co.
623 S. 16th Street
Omaha, Nebraska 68102

Catto & Putty, Inc.
P. O. Box 2408
510 Soledad Street
San Antonio, Texas 78205

Center Supply Company
6867 New Hampshire Avenue
Takoma Park, Maryland 20012

Dixie Sales Company
P. O. Box 1408
327 Battleground Avenue
Greensboro, North Carolina 27402

East Point Cycle & Key Shop
1617 Whiteway
East Point, Georgia 30044

Gamble Distributors
West End Avenue
Carthage, New York 13619

Garden Equipment Co., Inc.
6600 Cherry Avenue
Long Beach, California 90805

Gardenville Supply, Inc.
Pipersville, Pennsylvania 18947

Henry W. O'Neil & Assoc., Inc.
410 North Goodman Street
Rochester, New York 14609

Henzler, Inc.
2015 Lemay Ferry Road
St. Louis, Missouri 63125

Kenton Supply
8216 North Denver Avenue
Portland, Oregon 97217

Kimber's Inc.
115 W. Geddes St.
Syracuse, New York 13204

The Lawnmower Shop
1340 El Camino Real
San Carlos, California 94070

Marr Brothers
423 E. Jefferson
Dallas, Texas 75203

Mathews Auto Electric Co.
420 East 2nd Street
Tulsa Oklahoma 74120

McClure Lawn & Garden Supply
1114 Lexington Avenue
Mansfield, Ohio 44907

Memphis Cycle & Supply Co.
421 Monroe Avenue
Memphis Tennessee 38103

Morton B. Collins Co.
300 Birnie Avenue
Springfield, Massachusetts 01107

Moz-All of Florida, Inc.
365 Greco Avenue
Coral Gables, Florida 33146

National Central, Div. of
Joe Sterling, Inc.
Drawer "D" 687 Seville Rd.
Wadsworth, Ohio 44281

Parts & Sales Inc.
2101 Industrial Pkwy.
Elkhart, Indiana 46514

Power Equipment Distributor
36463 So. Gratiot Avenue
Mt. Clemens, Michigan 48043

Power Lawn & Garden Equip. Co.
2551-2571 J. F. Kennedy Road
Dubuque, Iowa 52001

Radco Distributors
2403 Market Street
P. O. Box 3216
Jacksonville, Florida 32206

Raub Supply Company
James & Mulberry Sts.
Lancaster, Pennsylvania 17604

Richmond Battery & Ignition
P. O. Box 25369 - 957 Myers St.
Richmond, Virginia 23260

Smith Hardware Company
515 N. George Street
Goldsboro, North Carolina 27530

South Denver Lawn Equip. Co.
527 West Evans
Denver, Colorado 80223

Suhren Engine
8330 Earhart Blvd.
New Orleans, Louisiana 70118

Sutton's Lawn Mower Shop
Route 4, Box 343
North Little Rock, Arkansas 72117

Warner Equipment
7520 Lyndale Avenue, So.
Minneapolis, Minnesota 55423

Woodson Sales & Service
1702 North Sylvania
Ft. Worth, Texas 76111

WARRANTY PARTS AND SERVICE POLICY

The purpose of warranty is to protect the customer from defects in workmanship and materials, defects which are NOT detected at the time of manufacture. It does not provide for the unlimited and unrestricted replacement of parts. Use and maintenance are the responsibility of the customer. The manufacturer cannot assume responsibility for conditions over which it has no control. Simply put, if it's the manufacturer's fault, it's the manufacturer's responsibility; if it's the customer's fault, it's the customer's responsibility.

CLAIMS AGAINST THE MANUFACTURER'S WARRANTY INCLUDES

1. Replacement of Missing Parts on new equipment.
2. Replacement of Defective Parts within the warranty period.
3. Repair of Defects within the warranty period.

All claims MUST be substantiated with the following information:

1. Model Number of unit involved.
2. Date unit was purchased or first put into service.
3. Date of failure.
4. Nature of failure.