

Patent 6253416

# BILLY GOAT POWER RAKE AND OVERSEEDER

PR550, PR550H, PR550T, PR500HT, OS551, OS551H

## Owner's Manual

<p>A complete verticising reel for your PR. 20" wide reel for use in grasses that require vertical cutting, and for assisting in lawn overseeding projects.</p>	<p>A full set of blades for replacement. Includes new lockwashers for replacement installation.</p>	<p>The new light weight Plastic Overseeding Kit is constructed of durable High Density Polypropylene with two lift handles on each side to assist in lifting the entire unit and easily converts a PR Series Power Rake into an overseeder with 4 bolts and minimal tools.</p> <p>Overseeder Conversion Kit (350328) includes Slicing Reel (350343). Part No. (350325) comes with the Overseeder Box only.</p>	<p>A complete set of our high quality flail blades for your PR. Includes new lock clips for replacement installation.</p>	<p>A full set of shafts for replacement. Includes new lock clips for replacement installation.</p>
---	---	--	---	--



## ABOUT THIS MANUAL

**THANK YOU** for purchasing a BILLY GOAT<sup>®</sup> *Power Rake/Overseeder*. Your new machine has been carefully designed and manufactured to provide years of reliable and productive service. This manual provides complete operating and maintenance instructions that will help to maintain your machine in top running order. Read this manual carefully before assembling, operating, or servicing your equipment.

## CONTENTS

SERIAL PLATE DATA AND SPECIFICATIONS _____	3
GENERAL SAFETY _____	4-5
SOUND AND VIBRATION _____	6
INSTRUCTION LABELS _____	7
PACKING CHECKLIST & ASSEMBLY _____	8
OPERATION _____	9-12
MAINTENANCE _____	13
TROUBLESHOOTING AND WARRANTY PROCEDURE _____	14
ILLUSTRATED PARTS LIST _____	15-18
PARTS LIST _____	19
MAINTENANCE RECORD _____	20



**SERIAL PLATE DATA**

Record the model number, serial number, date of purchase, and where purchased.

Purchase Date: \_\_\_\_\_

Purchased From: \_\_\_\_\_

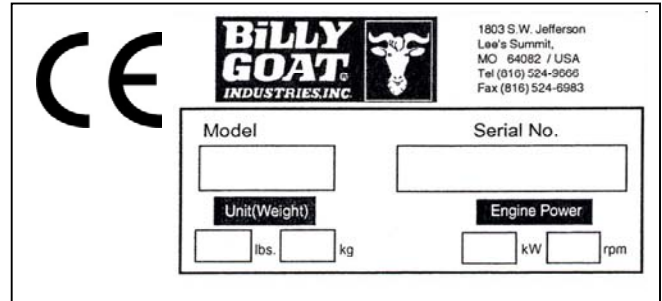

**Specifications**

	<b>PR550</b>	<b>PR550H</b>	<b>OS551</b>	<b>OS551H</b>	<b>PR550T</b>	<b>PR550HT</b>
Engine: HP	5.5 (4.1 kW)	5.5 (4.1 kW)	5.5 (4.1 kW)	5.5 (4.1 kW)	5.5 (4.1 kW)	5.5 (4.1 kW)
Engine: Model	1104020191	GX160T1QX2	1104020191	GX160T1QX2	1104020191	GX160T1QX2
Engine: Type	B&S OHV	HONDA OHV	B&S OHV	HONDA OHV	B&S OHV	HONDA OHV
Engine: Fuel Capacity	3.0 qt. (2.84 L)	3.88 qt. (3.6 L)	3.0 qt. (2.84 L)	3.88 qt. (3.6 L)	3.0 qt. (2.84 L)	3.88 qt. (3.6 L)
Engine: Oil Capacity	0.66 qt. (0.62 L)	0.69 qt. (0.65 L)	0.66 qt. (0.62 L)	0.69 qt. (0.65 L)	0.66 qt. (0.62 L)	0.69 qt. (0.65 L)
Total Unit Weight:	149# (67.7 kg)	147# (66.8 kg)	162# (73.6 kg)	160# (72.7 kg)	139# (63.2 kg)	137# (62.3 kg)
Engine weight:	36# (16.3 kg)	34# (15.4 kg)	36# (16.3 kg)	34# (15.4 kg)	36# (16.3 kg)	34# (15.4 kg)
Max. operating slope	15°	20°	15°	15°	20°	20°
Sound test in accordance with 2000/14/EC	101 dB(a)	101 dB(a)	101 dB(a)	101 dB(a)	101 dB(a)	101 dB(a)
Sound at operators ear	82 dB(a)	82 dB(a)	82 dB(a)	82 dB(a)	82 dB(a)	82 dB(a)
Vibration at operator position	0.82g (8.04 m/s <sup>2</sup> )	0.82g (8.04 m/s <sup>2</sup> )	3.2g	3.2g	3.2g	3.2g



## GENERAL SAFETY INSTRUCTIONS and SYMBOLS

The safety symbols shown below are used throughout this manual. You should become familiar with them before assembling, operating, or servicing this equipment.



**WARNING:** This symbol indicates important information that will prevent injury to yourself or others.



This symbol indicates ear protection is recommended when operating this equipment.



This symbol indicates eye protection is recommended when operating this equipment.



This symbol indicates gloves should be worn when servicing this equipment.



This symbol indicates that this manual and the engine manufacturer's manual should be read carefully before assembling, operation, or servicing this equipment.



**CAUTION:** This symbol indicates important information that will prevent damage to your BILLY GOAT<sup>®</sup> Power Rake/Overseeder.



This symbol indicates the engine oil level should be checked before operating this equipment.

Read and make sure you thoroughly understand the following safety precautions before assembling, operating or servicing this equipment:



**READ** this manual and the engine manufacturer's manual carefully before assembling, operating, or servicing this equipment.



**EAR PROTECTION** is recommended when operating this equipment.



**EYE PROTECTION** is recommended when operating this equipment.



**BREATHING PROTECTION** is recommended when operating this equipment.























**WARNING:** **EXHAUST** from this product contains chemicals known to the State of California to cause cancer, birth defects or other reproductive harm.

**DO NOT** operate this equipment on any unimproved forested, brushy, or grass covered land unless a spark arrester is installed on the muffler as required by Section 4442 of the California Public Resources Code. The arrester must be maintained in good working order. Other states may have similar laws. Federal laws apply on federal lands.

**DO NOT** run engine in an enclosed area. Exhaust gases contain carbon monoxide, an odorless and possibly fatal poison.



**WARNING:**

-  **DO NOT** run this equipment indoors or in any poorly ventilated area. Refueling outdoors is recommended.
  -  **DO NOT** refuel this equipment while the engine is running. Allow engine to cool for at least two minutes before refueling.
  -  **DO NOT** store gasoline near an open flame.
  -  **DO NOT** remove gas cap while engine is running.
  -  **DO NOT** start or operate engine if strong odor of gasoline is present.
  -  **DO NOT** start or operate engine if gasoline is spilled. Move equipment away from spill until gasoline has completely evaporated.
  -  **DO NOT** smoke while filling the fuel tank.
  -  **DO NOT** check for spark with spark plug or spark plug wire removed. Use an approved spark tester.
  -  **DO NOT** operate engine without a muffler. Inspect muffler periodically and replace if necessary. If equipped with muffler deflector, inspect deflector periodically and replace if necessary.
  -  **DO NOT** operate engine with grass, leaves or other combustible material near the muffler.
  -  **DO NOT** touch muffler, cylinder, or cooling fins when hot. Contact with hot surfaces may cause severe burns.
  -  **DO NOT** leave equipment unattended while in operation.
  -  **DO NOT** park equipment on a steep grade or slope.
  -  **DO NOT** operate equipment with bystanders in or near the work area.
  -  **DO NOT** allow children to operate this equipment.
  -  **DO NOT** operate equipment with guards removed.
  -  **DO NOT** operate equipment near hot or burning debris or any toxic or explosive materials.
  -  **DO NOT** operate equipment on slopes greater than specified in Specifications section of this manual.
  -  **DO NOT** start engine without height adjust lever in up position and clutch bail disengaged.
  -  **DO NOT** place hands or feet underneath unit, or near any moving parts.
- ALWAYS** remove spark plug wire when servicing equipment to prevent accidental starting.
- ALWAYS** check fuel lines and fittings frequently for cracks or leaks. Replace if necessary.
- ALWAYS** keep hands and feet away from moving or rotating parts.
- ALWAYS** store fuel in approved safety containers.



**WARNING: Important**

Remove all rocks, wire, string, etc. that can present a hazard during work prior to starting.



**DO** identify and mark all fixed objects to be avoided during work such as sprinkler heads, water valves, buried cables, or clothes line anchors, etc.



## SOUND



**L<sub>WA</sub>**  
**101 dB**

SOUND LEVEL 82 dB(a) at Operators Position

Sound tests were conducted in accordance with 2000/14/EC, and were performed on 2-13-2002 under the conditions listed below.

 Sound power level listed is the highest value for any model covered in this manual. Please refer to serial plate on the unit for the sound power level for your model.

General Conditions:	Sunny
Temperature:	48°F (8.9°C)
Wind Speed:	2 mph (3.2 kmh)
Wind Direction:	South East
Humidity:	29%
Barometric Pressure:	30.34Hg (770 mm Hg)

## VIBRATION DATA

VIBRATION LEVEL .82g (8.04m/s<sup>2</sup>)

Vibration levels at the operator's handles were measured in the vertical, lateral and longitudinal directions using calibrated vibration test equipment. Tests were performed on 5-25-2006 under the conditions listed below.

General Conditions:	Sunny
Temperature:	72.32°F (22.4°C)
Wind Speed:	3.8 mph (6.12kph)
Wind Direction:	East
Humidity:	62.2%
Barometric Pressure:	29.9Hg (101.3kpa)

## INTENDED USE

**INTENDED USE:** This machine is designed for removing thatch from your lawn, renovation of existing lawns, and to assist in overseeding operations. The machine should not be used for any other purpose than that stated above.

Do not operate if excessive vibration occurs. If excessive vibration occurs, shut engine off immediately and check for damaged or worn reel, loose pulley bolts or set screws, loose engine or lodged foreign objects. (See trouble shooting section on page 14).



## INSTRUCTION LABELS

The labels shown below were installed on your BILLY GOAT® Power Rake/Overseeder. If any labels are damaged or missing, replace them before operating this equipment. Item numbers from the Illustrated Parts List and part numbers are provided for convenience in ordering replacement labels. The correct position for each label may be determined by referring to the Figure and Item numbers shown.



**LABEL DANGER KEEP HANDS AND FEET AWAY**  
ITEM #51 P/N 400424



**LABEL CLUTCH ITEM #49**  
P/N 830503



**DANGER FLYING DEBRIS**  
ITEM # 48 P/N 810736



**LABEL CAUTION GUARDS**  
ITEM #52 P/N 900327

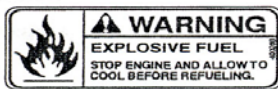

**LABEL EXPLOSIVE FUEL**  
ITEM # 50 P/N 400268

**LABEL INSTRUCTION HEIGHT ADJ.**  
ITEM #35 P/N 350176

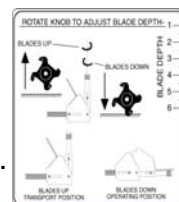

**LABEL INSTRUCTIONS SEEDER BOX**  
ITEM #45 P/N 350288

LAWN PREPARATION:				SEED APPLICATION CHART:																																																																																	
MOW LAWN TO LOWEST SETTING ON YOUR MOWER. DO NOT WATER PRIOR TO SEEDING. POWER RAKE TO DETATCH LAWN AND REMOVE THATCH. FERTILIZE LAWN WITH BROADCAST SPREADER.				THESE SETTINGS ARE APPROXIMATE GUIDELINES. SEEDING RATES ARE SPEED DEPENDENT. FASTER TRAVEL DELIVERS LESS SEED.																																																																																	
SEEDING RECOMMENDATIONS:				REFERENCE CHART:																																																																																	
FOR BEST RESULTS OVERSEED IN TWO PHASES OF ONE-HALF APPLICATION RATE AT RIGHT ANGLES OR IN A CROSS-CROSS PATTERN. WATER HEAVILY IMMEDIATELY THEN LIGHTLY FOR 10 - 14 DAYS KEEPING SOIL MOIST. AFTER GERMINATION, WATER LESS OFTEN TO PROMOTE GROWTH.				<table border="1"> <thead> <tr> <th>SEED TYPE</th> <th>RATE LBS/FT<sup>2</sup></th> <th>STOP SETTING</th> <th>SEED TYPE</th> <th>RATE LBS/FT<sup>2</sup></th> <th>STOP SETTING</th> </tr> </thead> <tbody> <tr> <td>RYEGRASS</td> <td>1/2</td> <td>1</td> <td>BENTGRASS</td> <td>1/2</td> <td>1</td> </tr> <tr> <td>3/4</td> <td>3</td> <td>2</td> <td>1/4 BENTGRASS</td> <td>1/2</td> <td>2</td> </tr> <tr> <td>1 1/2</td> <td>3</td> <td>3</td> <td>SHRUB &amp; DOGWOOD</td> <td>1/2</td> <td>3</td> </tr> <tr> <td>2 1/2</td> <td>4</td> <td>4</td> <td></td> <td></td> <td></td> </tr> <tr> <td>BLUEGRASS</td> <td>1/2</td> <td>3</td> <td>CENTPEPPERGRASS</td> <td>1/2</td> <td>1</td> </tr> <tr> <td>1</td> <td>4</td> <td>4</td> <td>SCORPION</td> <td>1 1/2</td> <td>2</td> </tr> <tr> <td>1 1/2</td> <td>3</td> <td>5</td> <td>SCRUB</td> <td>1 1/2</td> <td>3</td> </tr> <tr> <td>2 1/2</td> <td>4</td> <td>6</td> <td></td> <td></td> <td></td> </tr> <tr> <td></td> <td></td> <td></td> <td>SET ADJUSTING</td> <td>1/4</td> <td>2</td> </tr> <tr> <td></td> <td></td> <td></td> <td>GRASS</td> <td>1 1/2</td> <td>4</td> </tr> <tr> <td></td> <td></td> <td></td> <td></td> <td></td> <td></td> </tr> <tr> <td></td> <td></td> <td></td> <td></td> <td>1 1/2</td> <td>6</td> </tr> </tbody> </table>				SEED TYPE	RATE LBS/FT <sup>2</sup>	STOP SETTING	SEED TYPE	RATE LBS/FT <sup>2</sup>	STOP SETTING	RYEGRASS	1/2	1	BENTGRASS	1/2	1	3/4	3	2	1/4 BENTGRASS	1/2	2	1 1/2	3	3	SHRUB & DOGWOOD	1/2	3	2 1/2	4	4				BLUEGRASS	1/2	3	CENTPEPPERGRASS	1/2	1	1	4	4	SCORPION	1 1/2	2	1 1/2	3	5	SCRUB	1 1/2	3	2 1/2	4	6							SET ADJUSTING	1/4	2				GRASS	1 1/2	4											1 1/2	6
SEED TYPE	RATE LBS/FT <sup>2</sup>	STOP SETTING	SEED TYPE	RATE LBS/FT <sup>2</sup>	STOP SETTING																																																																																
RYEGRASS	1/2	1	BENTGRASS	1/2	1																																																																																
3/4	3	2	1/4 BENTGRASS	1/2	2																																																																																
1 1/2	3	3	SHRUB & DOGWOOD	1/2	3																																																																																
2 1/2	4	4																																																																																			
BLUEGRASS	1/2	3	CENTPEPPERGRASS	1/2	1																																																																																
1	4	4	SCORPION	1 1/2	2																																																																																
1 1/2	3	5	SCRUB	1 1/2	3																																																																																
2 1/2	4	6																																																																																			
			SET ADJUSTING	1/4	2																																																																																
			GRASS	1 1/2	4																																																																																
				1 1/2	6																																																																																

**CAUTION**

**READ OWNERS MANUAL BEFORE OPERATING**

**USE PERSONAL PROTECTION EQUIPMENT**

**PROTECT BYSTANDERS FLYING DEBRIS**

**BEFORE STARTING, MAKE SURE:**

- HEIGHT ADJUST LEVER IS UP POSITION.
- ALL GUARDS ARE ATTACHED.
- FOR PREVENTATIVE MAINTENANCE:
- CHECK ENGINE OIL ONLY.
- PURIFY AND CLEAN ENGINE AIR FILTER.
- ONLY REPLACE AS NEEDED.
- CONTROL LEVER MUST BE IN OIL CHANGE POSITION.
- REMOVE EXCESSIVE OIL AND OIL RESIDUE WITH WIPERS AND CLEANED PARTS.
- NEVER OPERATE EQUIPMENT WITHOUT PROPER MAINTENANCE.
- RECOMBIBUT SPARK PLUGS MUST BE REPLACED EVERY FOUR (4) HOURS REQUIRED TO SERVICE THE MACHINE.

## ENGINE LABELS

### BRIGGS & STRATTON

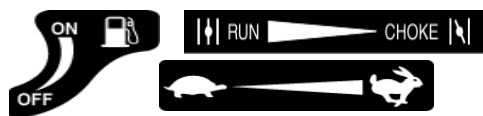

**WARNING**

- Read and follow Operating Instructions before running engine.
- Gasoline is flammable. Allow engine to cool at least 2 minutes before fueling.
- Engines emit carbon monoxide. DO NOT run in enclosed area.

### HONDA

IMPORTANT ENGINE INFORMATION-HONDA MOTOR CO. LTD  
 ENGINE FAMILY:TH163U1G1RA DISPLACEMENT : 163cm<sup>3</sup>  
 (LINE)IP SPECIFICATION: REFER TO OWNER'S MANUAL FOR  
 DRAINAGE SPECIFICATIONS AND MAINTENANCE PRECAUTIONS. FUEL  
 DRAINAGE SPECIFICATIONS ARE SUBJECT TO CHANGE WITHOUT NOTICE.

**OIL ALERT**

**WHEN OIL LEVEL LOW, ENGINE STOPS IMMEDIATELY.**

**READ OWNER'S MANUALS BEFORE OPERATION.**  
**LIRE LE MANUEL D'UTILISATEUR AVANT USAGE.**  
**VOR INBETRIEBNAHME UNBEDINGT BEDIENUNGSANLEITUNG DURCHLESEN.**  
**NO UTILIZAR SIN ANTES NO HABER LEIDO EL MANUAL.**

## ENGINE CONTROLS

Honda

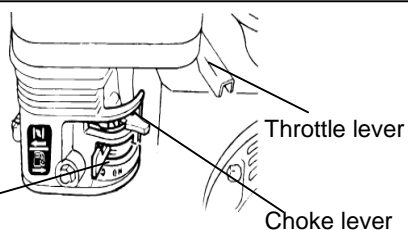

Fuel valve

Choke lever

Briggs & Stratton

Set lever to choke when starting cold

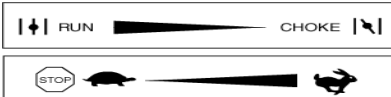

Set lever to desired engine speed.  
 Move lever completely to the left to



stop engine

## PACKING CHECKLIST

Your Billy Goat Power Rake is shipped from the factory in one carton, completely assembled.



**READ** all safety instructions before assembling unit.

**TAKE CAUTION** when removing the unit from the box the Handle Assembly is attached to the unit by cables.



**PUT OIL IN ENGINE BEFORE STARTING**

## PARTS BAG & LITERATURE ASSY

Warranty card P/N- 400972, Owner's Manual P/N-350324, Declaration of Conformity P/N-350139.

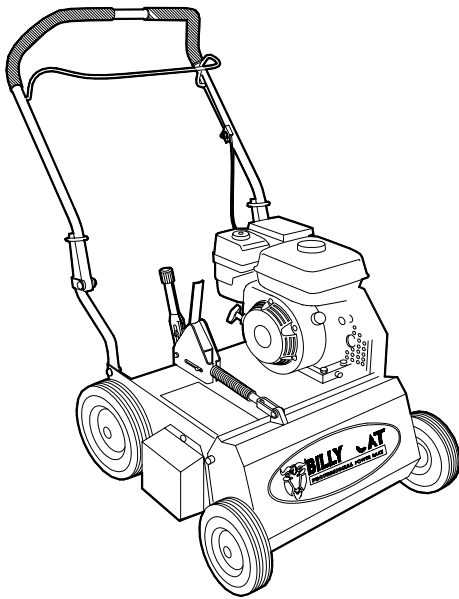

- Briggs & Stratton  
5.5 Intek OHV
- Honda 5.5 OHV
- Literature Assy  
P/N-430334

## ASSEMBLY

1. **UNFOLD** the upper handle (item 26) and slide handle lock loops (item 28) into place to secure the upper handle to the lower.
2. **CHECK** engine oil level and fill to proper level with engine manufacturers recommended grade of oil. Move height adjust lever to down position, to level engine during checking. See engine manufacturers instruction manual.
3. **CONNECT** spark plug wire.





## OPERATION

Like all mechanical tools, reasonable care must be used when operating machine.

**Inspect machine work area and machine before operating. Make sure that all operators of this equipment are trained in general machine use and safety.**

**PUT OIL IN ENGINE BEFORE STARTING**

### STARTING

**ENGINE:** See engine manufacturer's instructions for type and amount of oil and gasoline used. Engine must be level when checking and filling oil and gasoline.

**FUEL VALVE:** Move fuel valve to "ON" position (when provided on engine).

**STOP SWITCH:** Located on the engine. "ON" position.

**CHOKE:** Operated with choke lever on side of engine.

**THROTTLE:** Controlled by throttle lever on the motor.

See Troubleshooting on page 14.

### FOLDING HANDLE

This unit is equipped with a folding upper handle for easier storage and transportation. The handle can be folded by sliding the handle lock loops (item 28) up. This releases the upper handle, allowing it to be folded over the unit.

### HANDLING & TRANSPORTING:

This unit requires two people to lift it. With the handle in the folded position, lift holding the lower handle and belt/shaft guard one on each side of the machine. Secure the machine in place during transport. See page 3 for weight specifications

Never lift the machine while the engine is running.

### ADJUSTING BLADE DEPTH

The depth of the blades can be raised or lowered by rotating the knob on the top of the adjustment lever. The blades are lowered by rotating the knob clockwise, and raised by rotating the knob counter-clockwise. The relative depth of the blades can be gauged by using the depth scale located on the right front corner of the engine base. With new blades installed the depth can be estimated as follows: 2.5 on the scale is even with the ground, 3 is equal to 0.25" deep, and 3.5 is equal to 0.5" deep

### BLADE POSITION & DEPTH CONTROL LEVER

The blades can be raised or lowered into the ground by height adjustment lever on the engine base. The height adjuster lock lever must be pushed back against the adjustment lever in order to lower the blades into the ground. The resulting blade depth can be adjusted higher or lower.

See ADJUSTING BLADE DEPTH.

### SPRING TINE CONVERSION

If are converting your Power rake to a spring tine reel, you will need to replace the spacer on the control lever to accommodate for the tine. First remove the clip (item 18), then unscrew the yoke (item 17), remove the washer (items 69) and insert the spacer (item 75) in front of the spring. Reassemble in reverse order.

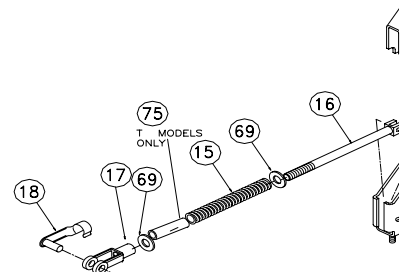
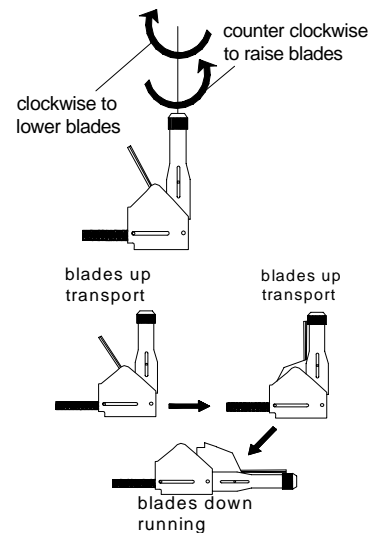



## RAKING/SLICING TIPS

Before beginning, it is best to evaluate the condition of the lawn by cutting one or more core samples from area to be treated. A core can be cut using a piece of pvc, or metal pipe. Hammer the pipe into the ground, remove it, push the core out of the pipe and inspect it to determine the depth of thatch in your yard.

**THATCH:** Thatch is a dense layer of dead grass, clippings, and roots that builds up over time at the base of the lawn preventing air, water, and fertilizer from reaching the soil. This can cause shallow root development and make a lawn more susceptible to drought and disease. Thatch also provides an ideal environment for insects to hide and multiply. Periodic removal of thatch will keep your lawn in good health.



**HEAVY THATCH:** Lawns with an excessive amount of thatch will require multiple treatments for effective removal. Trying to remove excessive thatch (greater than 3/4"[19 mm] deep) in one treatment will damage or destroy the living part of the lawn. It is best to remove heavy thatch in seasonal treatments (i.e. spring, and fall).

**SLOPES:** Rake slopes across not up and down. This is much easier and safer for the operator and is better for the lawn. Raking across will help to reduce runoff during watering and allow the sloped ground to hold more seed, fertilizer, and water. The units maximum operating slope is 35% or 19°.

**DEPTH:** The wide range of depth adjustment on your unit is provided to allow for blade wear. Setting the reel deeper will not produce better, or quicker results. The flail reel is intended to be set so it just touches the surface on flat ground. The slicing reel should be set even with the ground for verti-slicing work, and set to a maximum 1/2" depth for overseeding jobs. Setting the reel deeper than this will only result in premature wear on the unit (i.e. failed belt). If you desire to work the ground deeper than the above guidelines allow, it should be done gradually in multiple passes..

**SLICING / OVERSEEDING:** Mow the lawn to shorter than the normal cut height before starting (i.e. approximately 2" tall for fescue grass). For the best result, Slice/Overseed in criss-cross pattern (See Fig. 1 and See Fig 2).

## RAKING OPERATION-FLAIL REEL

**NOTE:** Must have the flail reel assembly (350112) for this operation.

**MOW:** Mow the lawn to it's normal cut height.

**DRY:** Be sure grass is dry. Wet conditions can cause increased damage to healthy grass.

**SET DEPTH:** With engine off, set the raking depth so that the blades just touch on a flat surface (i.e. driveway, or sidewalk).

**START ENGINE:** See page 9 for further instruction.

**ENGAGE BLADES:** Pull back on the bail on the operators handle. *When engaging the blades in heavy load conditions (i.e. heavy thatch, or very uneven turf), push down on the operators handle lifting the front wheels slightly. Engage the blades. Slowly lower the unit into the turf.*

**RAKE:** Rake a small test area and examine the results. Thatch should be removed and deposited on top of the healthy grass. If excessive damage occurs to healthy grass, adjust the blade depth to decrease damage. Continue raking the yard, working in one direction (i.e. north-south, or east-west). *If a large drop in engine RPM occurs, or the unit pulls you forward and bounces during operation the blade depth is set too low.*

**REMOVE THATCH:** After raking, a layer of thatch will be deposited over the top of the lawn. This thatch must be removed prior to any fertilizing, seeding, or watering of the lawn. We suggest the use of a lawn vacuum or wheeled blower for collection and removal of the thatch.



## RAKING OPERATION-SPRING REEL

**NOTE:** Must have the spring tine reel assembly (350354) for this operation.

**MOW:** Mow the lawn to it's normal cut height. Tall grass will not leave a manicured look when the dethatching job is complete.

**DRY:** Be sure grass is relatively dry. Wet conditions can cause increased damage to healthy grass.

**SET DEPTH:** With engine off, set the raking depth so that the spring tines are just above touching the flat surface (i.e. driveway, or sidewalk) the units height is being adjusted on. *Allowing the spring tines to have substantial contact with the ground will cause premature wear and failure of the spring tines.*

**START ENGINE:** See page 9 for further instruction.

**ENGAGE TINES:** Pull back on the bail on the operators handle. *When engaging the spring tines in heavy load conditions (i.e. heavy thatch, or very uneven turf), push down on the operators handle lifting the front wheels slightly. Engage the spring tines. Slowly lower the unit into the turf.*

**RAKE:** Rake a small test area and examine the results. Thatch should be removed and deposited on top of the healthy grass. If excessive damage occurs to healthy grass, adjust the spring tine depth to decrease damage. Continue raking the yard, working in one direction (i.e. north-south, or east-west).

*If a large drop in engine RPM occurs, or the unit pulls you forward and bounces during operation the spring tine depth is set too low.*

**REMOVE THATCH:** After raking, a layer of thatch will be deposited over the top of the lawn. This thatch must be removed prior to any fertilizing, seeding, or watering of the lawn. We suggest the use of a lawn vacuum or wheeled blower for collection and removal of the thatch.

## VERTI-CUTTING OPERATION

**NOTE:** Must have the slicing reel assembly (350113) for this operation.

**MOW:** Mow the lawn to shorter than the normal cut height (approximately 2" tall)

**DRY:** Be sure grass is dry. Wet conditions can cause increased damage to healthy grass.

**SET DEPTH:** With engine off, set the raking depth so that the blades just touch on a flat surface (i.e. driveway, or sidewalk).

**START ENGINE:** See Page 9.

**ENGAGE BLADES:** Pull back on the bail on the operators handle. *When engaging the blades in heavy load conditions (i.e. heavy thatch, or very uneven turf), push down on the operators handle lifting the front wheels slightly. Engage the blades. Slowly lower the unit into the turf.*

**SLICE:** Verti-cut a small test area and examine the results. Some thatch and cut stems should be removed and deposited on top of the healthy grass. Grass runners should be cut and ready for removal. If excessive damage occurs to healthy grass, adjust the blade depth to decrease damage. Continue raking the yard, working in one direction (i.e. north-south, or east-west).

*If a large drop in engine RPM occurs, or the unit pulls you forward and bounces during operation the blade depth is set too low.*

**REMOVE THATCH/STEMS:** After verti-cutting, a layer of thatch and cut stems will be deposited over the top of the lawn. We suggest the use of a lawn vacuum or wheeled blower for collection and removal of the thatch/stems.

## OVERSEEDING OPERATION

**NOTE:** Must have the slicing reel assembly (350113) for this operation.

**MOW:** Mow the lawn to shorter than the normal cut height (approximately 2" tall)

**DRY:** Be sure grass is dry. Wet conditions can cause increased damage to healthy grass.

**SEED:** Spread grass seed according to the seed suppliers directions (e.g. 10 lbs. per 1000 ft<sup>2</sup> [4.5 kg. per 93 m<sup>2</sup> ])

**SET DEPTH:** With engine off, set the raking depth so that the blades reach 1/4"-1/2" (6-12 mm) below a flat surface (i.e. driveway, or sidewalk).

**START ENGINE:** See Page 9.

**ENGAGE CLUTCH:** Pull back on the bail on the operators handle. *When engaging the clutch in heavy load conditions (i.e. heavy thatch, or very uneven turf), push down on the operators handle lifting the front wheels slightly. Engage the clutch. Slowly lower the unit into the turf.*

**SLICE:** Run machine over the area that has been seeded to incorporate the seed into the soil. If excessive damage occurs to healthy grass, adjust the blade depth to decrease damage. Continue raking the yard, working in one direction (i.e. north-south, or east-west). *If a large drop in engine RPM occurs, or the unit pulls you forward and bounces during operation the blade depth is set too low.*

**WATER/FERTILIZE:** After the seed has been worked into the soil, water and fertilize according to the seed suppliers directions.

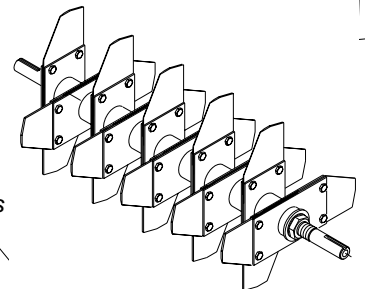
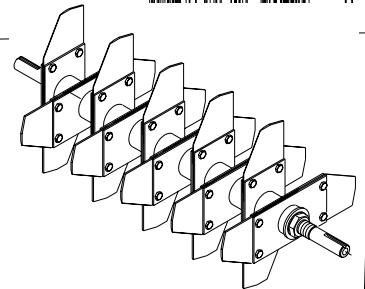



### ADJUSTING SEED RATE

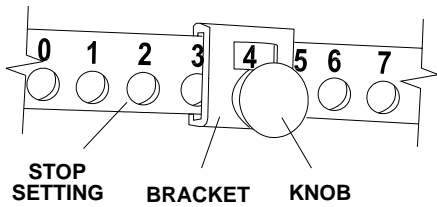

- PULL BACK ON THE KNOB THEN SLIDE THE BRACKET TO DESIRED STOP SETTING.
- STOP SETTING IS ON 4
- IF SLICING WITHOUT DROPPING SEEDS FOR LONG PERIOD THEN SET THE STOP SETTING TO ZERO.

### LAWN PREPARATION

- MOW LAWN TO LOWEST SETTING ON YOUR MOWER.
- DO NOT WATER PRIOR TO SEEDING.
- POWER RAKE TO DETHATCH LAWN AND REMOVE THATCH.
- FERTILIZE LAWN WITH BROADCAST SPREADER.

### LAWN PREPARATION

- FOR BEST RESULTS OVERSEED IN TWO PASSES OF ONE-HALF APPLICATION RATE EACH, AT RIGHT ANGLES OR IN A CRISS-CROSS PATTERN.
- WATER HEAVILY IMMEDIATELY THEN LIGHTLY FOR 10 - 14 DAYS, KEEPING SOIL MOIST.
- AFTER GERMINATION, WATER LESS OFTEN TO PROMOTE ROOT GROWTH.

### DROPPING SEEDS

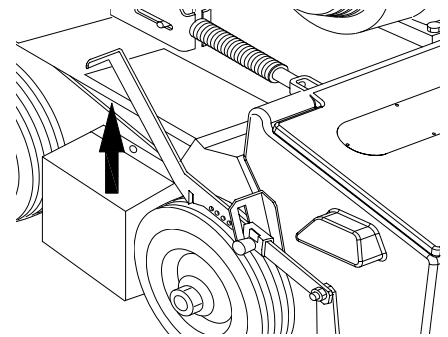

- AFTER ADJUSTING THE STOP SETTING, LIFT UP ON THE BAR TO OPEN THE DROP SEEDER DOOR.

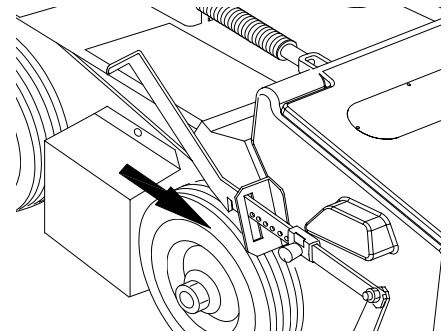

- TO STOP DROPPING SEEDS, PUSH FORWARD ON THE HANDLE TO CLOSE THE DROP SEEDER DOOR.
- IF SLICING WITHOUT DROPPING SEEDS FOR LONG PERIOD OF TIME THEN SET THE STOP SETTING TO ZERO.

## SEED APPLICATION CHART:

THESE SETTINGS ARE APPROXIMATE GUIDELINES. SEEDING RATES ARE SPEED DEPENDENT. FASTER TRAVEL DELIVERS LESS SEED.

SEED TYPE	RATE LBS 1,000 FT <sup>2</sup>	STOP SETTING
RYEGRASS	1/2	1
	3/4	2
	1 1/2	3
	2 1/3	4
BLUEGRASS	3/4	3
	1	4
	1 1/2	5
FESCUE	2 1/2	6
	3/4	5
	1 1/4	6
	2	7
	3 1/2	8

SEED TYPE	RATE LBS 1,000 FT <sup>2</sup>	STOP SETTING
BENTGRASS	2/3	1
	1 1/3	2
BERMUDAGRASS (HULLED & ZOYSIA)	3/4	1
	1 2/3	2
CENTIPEDEGRASS (COATED)	2/3	1
	1 1/4	2
	2 1/2	3
ST. AUGUSTINE GRASS	3/4	3
	1	4
	1 1/3	5
	1 1/2	6

BILLY GOAT SEEDER SETTING	SCOTTS SEEDER SETTING (ALL DROP SEEDER MODELS)
5	6 1/3
6	8
7	10
8	15 1/2
9	17



## MAINTENANCE

### PERIODIC MAINTENANCE

Periodic maintenance should be performed at the following intervals:

Maintenance Operation	Every Use (daily)	Every 25 Hours
Inspect for loose, worn or damaged parts.		●
Check engine oil	●	
Inspect belt		●
Engine (See Engine Manual)		
Grease reel bearings		●
Inspect and clean engine air filter	●	
Oil height adjustment linkage		●

### FLAIL BLADE WEAR

1. Wait for engine to cool and disconnect spark plug.
2. Close fuel valve on engine (if available).
3. Lean unit back onto lower handles and secure in place.
4. Inspect blades for wear, and immediately replace any bent or cracked blades. Measure the overall length of the blade. (See fig. 1)
5. If blades measure less than 3.25"(83 mm) in overall length they must be replaced. NOTE: We recommend replacing all the flails at once.

### SLICING BLADE WEAR

1. Wait for engine to cool and disconnect spark plug.
2. Close fuel valve on engine (if available).
3. Lean unit back onto lower handles and secure in place.
4. Inspect blades for wear, and immediately replace any bent or cracked blades. Measure the overall length of the blade from the center of the attachment bolt to the tip of the worn blade.
5. If blades measure less than 3"(76 mm) in length they must be replaced. NOTE: We recommend replacing all the blades at once.

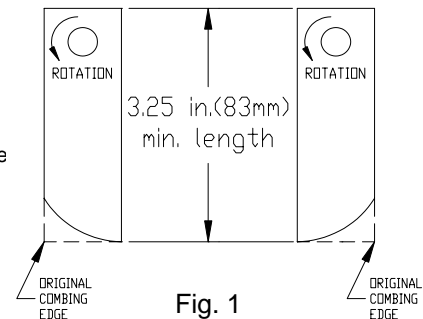

Fig. 1

### ROTATING FLAIL REEL END TO END

To maximize flail blade life and performance the reel can be rotated end to end periodically to provide a fresh lead cutting edge. Takes approx. 20 min. and requires 1/2" and 9/16" socket wrenches with extension bar.

1. Wait for engine to cool and disconnect spark plug.
2. Close fuel valve on engine (if available).
3. Lean unit back onto lower handles and secure in place.
4. Remove (7) lock nuts (item 62 & 40) holding the belt and shaft guards (item 21 & 22) in place. It is necessary to lower the height adjust lever to reach the locknuts on the guards. Remove the guards.
5. Remove the drive belt (item 9) by "walking" it out of the groove on the reel pulley (item 2).
6. Remove the (4) lock nuts (item 60) and washers (item 68) holding the bearings (item 23) to the frame of the unit.
7. The reel is now free from the machine. Slide the reel down and out of the machine.
8. Remove the capscrew (item 71), lockwasher (item 57), reel pulley (item 2), key (item 42), and reel spacer (item 10) from the end of the reel.
9. Rotate the reel end to end, and re-install these items on the opposite end of the reel.
10. Re-install the reel in reverse order of removal. Re-install the guards in reverse order of removal.

### DRIVE BELT REPLACEMENT

**NOTE:** Takes approx. 10 min. and requires 1/2" socket wrench with extension.

1. Wait for engine to cool and disconnect spark plug.
2. Remove (4) lock nuts (item 62) holding the belt guard (item 21) in place. It is necessary to lower the height adjust lever to reach the locknuts on the guard. Remove the guard.
3. Remove the belt (item 9) by rotating the reel pulley (item 2) and walking it out of the groove. Discard old belt
4. Install new belt using same procedure to walk the belt into the groove.
5. With new belt installed pull bail rod back to engaged position and measure extension of idler spring. Spring should stretch 3/4" - 1" (19 25 mm) with bail engaged. Adjust clutch cable as necessary to achieve this extension.
6. Re-install the belt guard.





**STORAGE**

⚠ Never store engine indoors or in enclosed poorly ventilated areas with fuel in tank, where fuel fumes may reach an open flame, spark or pilot light, as on a furnace, water heater, clothes dryer or other gas appliance.

**If engine is to be unused for 30 days or more, prepare as follows:**

⚠ Remove all gasoline from carburetor and fuel tank to prevent gum deposits from forming on these parts and causing possible malfunction of engine. Drain fuel outdoors, into an approved container, away from open flame. Be sure engine is cool. Do not smoke. Run engine until fuel tank is empty and engine runs out of gasoline.

**Troubleshooting**

Problem	Possible Cause	Solution
Abnormal vibration.	· Damaged or missing blades. Loose handle bolts. Loose engine bolts	· Stop work immediately. Replace any damaged or missing blades. Tighten all loose nuts and bolts.
Engine stalls or labors when raking	· Blades set too deep into ground.	· Raise blades so that they just touch the ground on a level surface
Engine will not start.	· Stop switch off (Honda only). Throttle in off position · Out of gasoline or bad, old gasoline.  · Spark Plug wire disconnected. · Gas valve off. · Dirty air cleaner.	· Check choke position.  · Check gasoline.  · Connect spark plug wire. · Turn on gas valve. · Clean or replace air cleaner. Contact a qualified service person.
Engine is locked, will not pull over.	· Debris locked against reel, or drive pulleys. Engine problem.	· Pull spark plug wire and remove debris. Contact an engine servicing dealer for engine problems.

When servicing engine refer to specific manufacturers engine owner's manual. Engine warranty is covered by the specific engine manufacturer. If your engine requires warranty or other repair work contact your local servicing engine dealer. When contacting a dealer for service it is a good idea to have your engine model number available for reference (See table page 3). If you cannot locate a servicing dealer in your area you can contact the manufacturers national service organization.

To reach:

**American Honda:** 800-426-7701

**WARRANTY CLAIM PROCEDURE**

Should a BILLY GOAT<sup>®</sup> machine fail due to a defect in material and/or workmanship, the owner should make a warranty claim as follows:

- The machine must be taken to the dealer from whom it was purchased or to an authorized Servicing BILLY GOAT Dealer.
- The owner must present the remaining half of the Warranty Registration Card, or, if this is not available, the invoice or receipt.
- The Warranty Claim will be completed by the authorized BILLY GOAT Dealer and submitted to their respective BILLY GOAT Distributor for their territory Attention: Service Manager. Any parts replaced under warranty must be tagged and retained for 90 days. The model number and serial number of the unit must be stated in the Warranty Claim.
- The distributor service manager will sign off on the claim and submit it to BILLY GOAT for consideration.
- The Technical Service Department at BILLY GOAT will study the claim and may request parts to be returned for examination. BILLY GOAT will notify their conclusions to the distributor service manager from whom the claim was received.
- The decision by the Technical Service Department at BILLY GOAT to approve or reject a Warranty Claim is final and binding.

For online product registration go to [www.billygoat.com](http://www.billygoat.com)



# POWER RAKE SEEDER BOX KIT

PARTS LIST			
ITEM NO.	PART NO.	DESCRIPTION	QTY
1	350366	BOX AND LID ASSEMBLY	1
2	350306	BRACKET ADJ DROP SEEDER	1
3	350276	BAR DOOR LINKGAGE	1
4	350320	SHAFT PLASTIC DROOP SEEDER	1
5	350271	PLATE DOOR DROP SEEDER	1
6	350272	PLATE DOOR DROP SEEDER END	1
7	350273	PLATE DOOR DROP SEEDER ARM	1
9	350370	PULLEY 3V GROOVE 0.625" BORE	1
10	8171003	WASHER 5/16 FLAT CUT	1
11	900321	BEARING CLIP 1.375 OD	4
12			
13	400217	SPRING TENSION	2
14	8024040	BOLT CARRAIGE 5/16 - 18 X 1	2
15	8024021	BOLT CARRIAGE 1/4-20 X 3/4"	1
16	8123087	SCREW SELF TAP #10-24 X 3/8" HMS ZP	4
17	8160001	NUT LOCK 1/4	2
18	350332	BRACKET SLOT PLASTIC SEEDER BOX	1
19	8160002	NUT LOCK 5/16	1
21	350369	PULLEY 3V GROOVE 1.530" BORE	1
22	8172013	WASHER FLAT 5/8 SAE ZP	2
24	350372	BELT O-RING 5/16 X 15 9/16"	1
25	8197031	PIN COTTER 1/8" X 1"	1
26	9195106	ROLL PIN 1/8 - 1 1/4	1
28	8172007	WASHER 1/4 SAE	1
29	8154007	NUT HEX 10-24	2
30	8059136	SCREWCAP #10-24 X 3/4	2
32	350288	LABEL INSTRUCTION SEEDER P	1
33	890456	LABEL HOSE PLUG KD/SV	1
32	350313	LABEL PRODUCT DECAL O	1

PARTS BAG SEEDER BOX KIT 350326			
15	8024021	BOLT CARRIAGE 1/4-20 X 3/4"	1
17	8160001	NUT LOCK 1/4	2
19	8160002	NUT LOCK 5/16	1
20	8177011	WASHER 1/4 SAE	4
23	8041026	SCREW SELF TAP #10-24 X 3/8" HMS ZP	4
27	8172020	WASHER 1/4 SAE	4
28	8172007	WASHER 1/4 SAE	2
31	8171006	WASHER 1/4 SAE	3
32	8161044	WASHER THIN HGT	1
-	350326	SEEDER BOX (INCLUDES TEMPLATE)	1



**PARTS DRAWING**

**FLAIL REEL KIT 350112**

**FLAIL SHAFT KIT 350185**

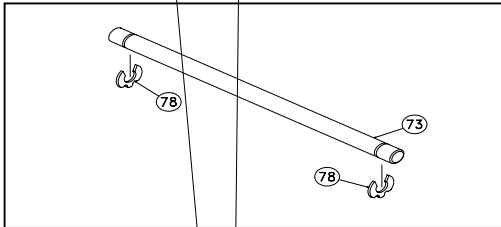

**FLAIL BLADE KIT 350186**

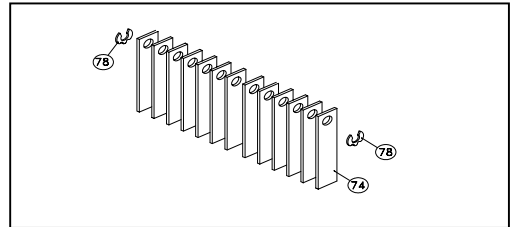

**SPACER BUMPER KIT 350258**

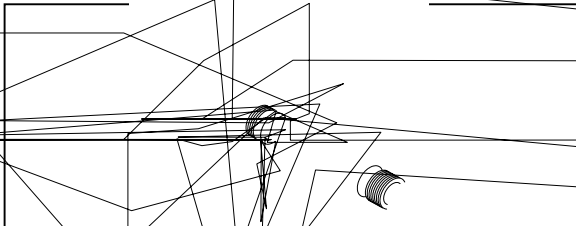

**SLICING BLADE KIT 350187**

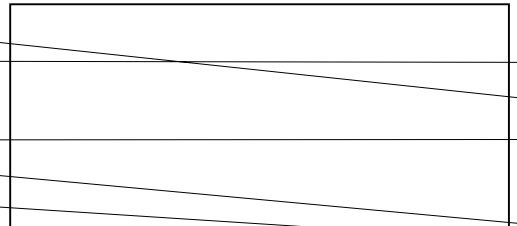





**PARTS DRAWING**

**SLICING REEL ASSY 350113**

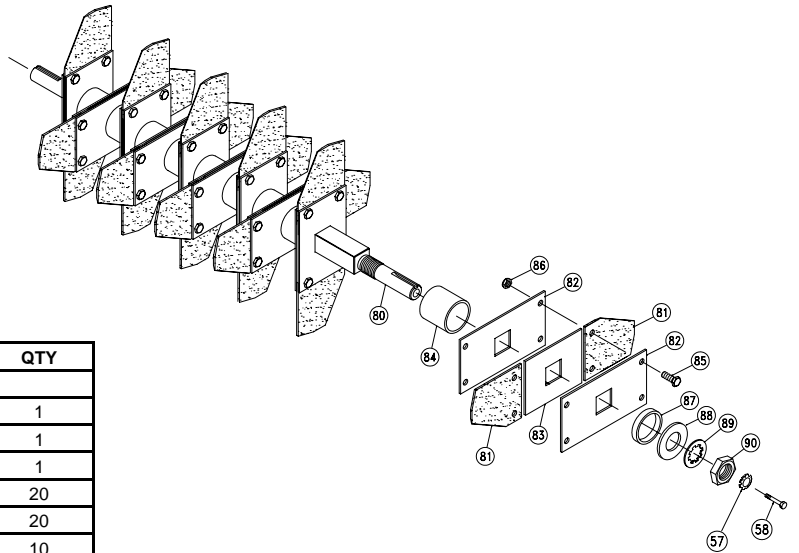

item no.	PARTS LIST	PR500 Part No.	QTY
57	LOCK WASHER 5/16 TWISTED TOOTH	800177	1
71	SCREWCAP 5/16 - 24 x 1" HCS GR. 5	400164	1
80	SHAFT SLICING WA	350142	1
81	BLADE SLICING REEL	350147	20
82	PLATE BLADE MTG.	350148	20
83	SPACER BLADE MTG.	350149	10
84	SPACER BLADE ASSY	350150	9
85	SCREWCAP 1/4-20 x 3/4, HCS ZP	8041004	40
86	NUT LOCK 1/4-20	8142004	40
87	COLLAR SPACER	350152	1
88	WASHER 0.937 x 1.750 x 0.119	350153	1
89	WASHER LOCK 7/8 INT. TOOTH	350154	1
90	NUT JAM 7/8-14	350155	1

**SPRING TINE REEL ASSY - 350355-S**

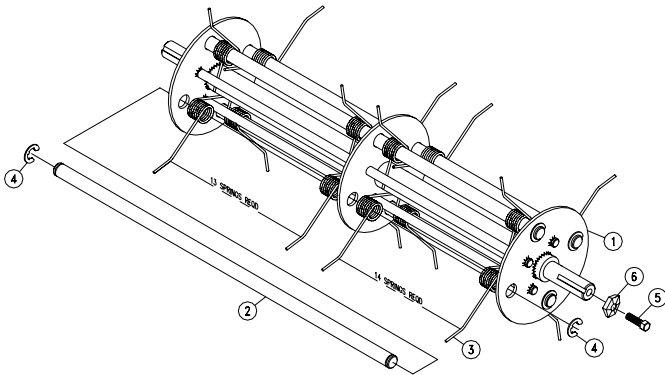

item no.	PARTS LIST	Part No.	QTY
1	SHAFT WA SPRING TINE REEL	350353	1
2	SHAFT SPRING TINE REEL	350351	4
3	SPRING TINE	350352	108
4	RING RETAINING 1/2"	350146	8
5	SCREWCAP 5/16"-24x1" GR. 5 ZP	400164	1
6	WASHER LOCK TWISTED TOOTH HEAVY	430298	1

**SPRING REPLACEMENT KIT - 350356-S**

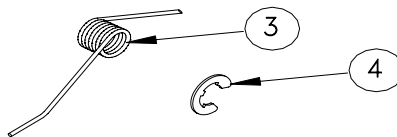

item no.	PARTS LIST	Part No.	QTY
3	SPRING TINE	350352	108
4	RING RETAINING 1/2"	350146	8



**PARTS DRAWING**

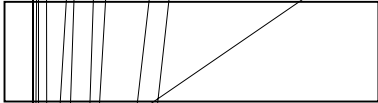

○ (21) SEE PAGE 15

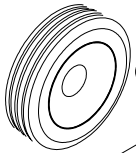

(35)

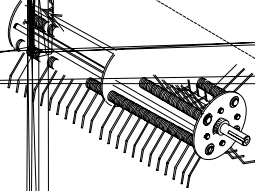



## PARTS LIST

item no.	PARTS LIST	PR550 Part No.	QTY	PR550H Part No.	QTY	OS551 Part No.	QTY	OS551H Part No.	QTY	PR550T Part No.	QTY	PR550HT Part No.	QTY
1	Pulley 3" OD	350101-01	1	350101	1	350101-01	1	350101	1	350101-01	1	350101	1
1A	Spacer Crank PR Honda	-	-	350339	1	-	-	350339	1	-	-	350339	1
2	Pulley 6.5" OD X 3/4"	350102	1	350102	1	350102	1	350102	1	350102	1	350102	1
3	Wheel 8" Front PR	350103	2	350103	2	350103	2	350103	2	350236	2	350236	2
4	Wheel 10" Front PR	350104	2	350104	2	350104	2	350104	2	350362	2	350362	2
5	Height Adjust Assy	350107	1	350107	1	350107	1	350107	1	350107	1	350107	1
6	Reel Flail / Slicing / Spring Assy	350112	1	350112	1	350113	1	350113	1	350354	1	350354	1
7	Pulley Idler 2.75"	350114	1	350114	1	350114	1	350114	1	350114	1	350114	1
8	Arm Idler WA	350115	1	350115	1	350115	1	350115	1	350115	1	350115	1
9	Belt 5L X 36	350116	1	350116	1	350116	1	350116	1	350116	1	350116	1
10	Spacer Reel Pulley	350118	1	350118	1	350118	1	350118	1	350118	1	350118	1
11	Bracket Mount Clutch Cable	350119	1	350119	1	350119	1	350119	1	350119	1	350119	1
12	Chassis WA W/ Label	350194	1	350194	1	350194	1	350194	1	350194	1	350194	1
13	Frame Front WA	350121	1	350121	1	350121	1	350121	1	350121	1	350121	1
14	Bushing 0.375 OD X 0.256 ID X 0.88	350309	1	350309	1	350309	1	350309	1	350309	1	350309	1
15	Spring Height Adjust PR500	350125	1	350125	1	350125	1	350125	1	350125	1	350125	1
16	Link Height Adjust PR500	350126	1	350126	1	350126	1	350126	1	350126	1	350126	1
17	Yoke 1/2 - 20	350127	1	350127	1	350127	1	350127	1	350127	1	350127	1
18	Pin Yoke 1/2"	350128	1	350128	1	350128	1	350128	1	350128	1	350128	1
19	Bracket Mount Hgt. Adj. WA	350182	1	350182	1	350182	1	350182	1	350182	1	350182	1
20	Spacer Spanner Wheel PR500	350130	4	350130	4	350130	4	350130	4	350130	4	350130	4
21	Guard Belt WA W/ Label	350195	1	350195	1	350195	1	350195	1	350195	1	350195	1
22	Guard Shaft WA W/ Label	350196	1	350196	1	350196	1	350196	1	350196	1	350196	1
23	Bearing 3/4" Cast Pillow Block	350133	2	350133	2	350133	2	350133	2	350133	2	350133	2
24	Handle Lower LH WA	350134	1	350134	1	350134	1	350134	1	350134	1	350134	1
25	Handle Lower RH WA	350135	1	350135	1	350135	1	350135	1	350135	1	350135	1
26	Handle Upper PR500	350375	1	350375	1	350375	1	350375	1	350375	1	350375	1
27	Bail Clutch WA	350374	1	350374	1	350374	1	350374	1	350374	1	350374	1
28	Loop Folding Handle	350138	2	350138	2	350138	2	350138	2	350138	2	350138	2
29	Deflector Rubber	350167	1	350167	1	350167	1	350167	1	350167	1	350167	1
30	Shield Bearing	350168	2	350168	2	350168	2	350168	2	350168	2	350168	2
31	Bar Clamp Deflector	350171	1	350171	1	350171	1	350171	1	350171	1	350171	1
32	Bracket Height Adjust Lock WA	350173	1	350173	1	350173	1	350173	1	350173	1	350173	1
33	Guard Pulley Back	350184	1	350174	1	350184	1	350174	1	350184	1	350174	1
34	Lever Height Control	350175	1	350175	1	350175	1	350175	1	350175	1	350175	1
35	Label Instr. Hgt. Adj.	350176	1	350176	1	350176	1	350176	1	350176	1	350176	1
36	Bolt Shoulder 1/4" x 1 3/4"	350178	1	350178	1	350178	1	350178	1	350178	1	350178	1
37	Bolt Shoulder 5/16" x 1 3/4"	350179	1	350179	1	350179	1	350179	1	350179	1	350179	1
38	Cable Clutch Reel PR500	350181	1	350181	1	350181	1	350181	1	350181	1	350181	1
39	Spring Extension	400217	1	400217	1	400217	1	400217	1	400217	1	400217	1
40	BOLT SHOULDER 1/2" X 1"	500114	1	500114	1	500114	1	500114	1	500114	1	500114	1
41	ENGINE HONDA 5.5 H.P. GX160	-	-	600115	1	-	-	600115	1	-	-	600115	1
	ENGINE INTEK 5.5HP OHV B&S	350197	1	-	-	350197	1	-	-	350197	1	-	-
42	KEY 3/16" X 1"	9201078	1	9201078	2	9201078	1	9201078	2	9201078	1	9201078	2
42A	KEY 1/4" x 1"	9201113	1	-	-	9201113	1	-	-	9201113	1	-	-
43	GRIP 1" x 13"	400570	2	400570	2	400570	2	400570	2	400570	2	400570	2
44	GRIP LEVER 1/8 x 1 x 5"	500181	1	500181	1	500181	1	500181	1	500181	1	500181	1
45	LABEL INSTRUCTION SEEDER BOX	-	-	-	-	350288	1	350288	1	-	-	-	-
46	WASHER 5/16 FC	8171003	2	8171003	2	8171003	8	8171003	6	8171003	8	8171003	5
47	FINGER BELT WIRE	350301	1	350301	1	350301	1	350301	1	350301	1	350301	1
48	LABEL DANGER THROWN OBJECT	810736	1	810736	1	810736	1	810736	1	810736	1	810736	1
49	LABEL CLUTCH VQ	830503	1	830503	1	830503	1	830503	1	830503	1	830503	1
50	LABEL HOT ENGINE	400268	1	400268	1	400268	1	400268	1	400268	1	400268	1
51	LABEL WARNING	400424	2	400424	2	400424	2	400424	2	400424	2	400424	2
52	LABEL DANGER GUARD	900327	1	900327	1	900327	1	900327	1	900327	1	900327	1
53	PLUG CAP 1" RD	890132	2	890132	2	890132	2	890132	2	890132	2	890132	2
54	BOLT CARRAIGE 3/8-16 x 1 3/4	8024061	4	8024061	4	8024061	4	8024061	4	8024061	4	8024061	4
55	BOLT CARRAIGE 5/16-18 x 1 3/4	8024043	2	8024043	2	8024043	2	8024043	2	8024043	2	8024043	2
56	BOLT CARRAIGE 5/16-18 x 3/4	8024039	4	8024039	4	8024039	5	8024039	5	8024039	5	8024039	5
57	LOCK WASHER TW. TOOTH	400502	1	400502	1	800177	1	800177	1	800177	1	800177	1
58	NUT LOCK #10-24	8164005	1	8164005	1	8164005	1	8164005	1	8164005	1	8164005	1
59	NUT LOCK 1/4-20	8160001	2	8160001	2	8160001	5	8160001	5	8160001	5	8160001	5
60	NUT LOCK 3/8-16	8160003	9	8160003	9	8160003	9	8160003	9	8160003	9	8160003	9
61	NUT LOCK 3/8-16 THIN	8161042	3	8161042	3	8161042	3	8161042	3	8161042	3	8161042	3
62	NUT LOCK 5/16-18	8160002	18	8160002	18	8160002	19	8160002	19	8160002	19	8160002	19
63	SCREW CAP 1/4-20 x 1 1/2	8041008	1	8041008	1	8041008	1	8041008	1	8041008	1	8041008	1
64	SCREW CAP 3/8 - 16 x 1 1/2	8041052	1	8041052	1	8041052	1	8041052	1	8041052	1	8041052	1
65	SCREW CAP 5/16-24 x 3/4" GR. 5	8042026	3	8042026	4	8042026	3	8042026	4	8042026	3	8042026	4
65A	Washer 3/4 SAE	-	-	8172015	1	-	-	8172015	1	-	-	8172015	1
65B	Washer 5/16 Twist Tooth	-	-	430298	1	-	-	430298	1	-	-	430298	1
66	SCREW CAP 5/16 - 18 x 1 1/2	8041030	4	8041030	4	8041030	4	8041030	4	8041030	4	8041030	4
67	SCREW CAP 5/16-24 X 1	400164	1	400164	1	400164	1	400164	1	400164	1	400164	1
68	WASHER 3/8 FLAT CUT	8171004	8	8171004	8	8171004	8	8171004	8	8171004	8	8171004	8

