



BY APPOINTMENT TO  
H.M. THE QUEEN  
MANUFACTURERS OF  
AGRICULTURAL MACHINERY  
HAYTERS P.L.C.

# HAYTER

## HUNTER 54

PROFESSIONAL

PUSH & AUTODRIVE MODELS

## ROTARY LAWNMOWER

FROM MACHINE NUMBER 335 001001















FROM MACHINE NUMBER 336 001001









### OPERATING INSTRUCTIONS ILLUSTRATED PARTS LIST

**HAYTERS P.L.C. BISHOP'S STORTFORD • HERTS CM23 4BU • ENGLAND**

## SAFETY PRECAUTIONS (As recommended in B.S.5107 : 1974)

-  Know your controls. Read the owner's manual carefully. Learn how to stop the engine quickly in any emergency.
-  Make sure the lawn is clear of sticks, stones, bones, wire and debris. They could be thrown by the blade.
-  Stop the engine and disconnect spark plug wire before checking or working on the mower.
-  Damaged cutterbars and loose fixing bolts are major hazards. Before using, always visually inspect the cutting mechanism to ensure that it is in good condition. A damaged cutterbar should be replaced immediately, using only Hayter replacement cutterbars. Cutterbars can be re-sharpened, ensure that both cutting edges are evenly sharpened to maintain the balance.
-  Always be sure the mower is in safe operating condition. Check all nuts, bolts and screws often. Use only replacement parts made and guaranteed by HAYTERS P.L.C.
-  Add fuel BEFORE starting the engine. Avoid spilling petrol and do not fill the tank while the engine is running or while you are smoking.
-  Do not mow whilst people, especially children, or pets are in the mowing area.
-  Never use the mower unless the guards provided by the Manufacturers are in position.
-  Do not mow barefoot or in open sandals.
-  Do not operate the engine in a confined space where exhaust fumes (carbon monoxide) can collect.
-  Start the engine carefully with feet well away from the blades.
-  Stop the engine whenever you leave the mower.
-  Do not allow children or people unfamiliar with these instructions to use the mower.
-  On slopes or wet grass, be extra careful of your footing.
-  Never cut grass by pulling the mower towards you.

-  Do not overspeed the engine or alter governor settings. Excessive speed is dangerous and shortens mower life.
-  Warning: Blades continue to rotate after machine is switched off.
-  When using the machine without the grassbox, do not lift the deflector plate whilst the machine is in operation.
-  Never insert hand into grass discharge chute whilst the engine is running.
-  Stop the engine before pushing the mower across gravel drives, walks or roads.
-  Never pick up or carry a mower when it is operating.

The Hayter Hunter is perfectly safe if used correctly. Failure to observe these simple precautions may result in serious injury.

## INTRODUCTION

The Hayter Hunter 54 is robustly constructed and designed to give an efficient economical performance, combined with ease of operation. The correct operation and attention to routine maintenance as recommended will ensure long and efficient service from the machine. It is important that the machine is not abused or neglected.

The machine is carefully checked at our Works prior to despatch and every effort is made by Hayters to see that the machine arrives in perfect condition. Your Dealer will ensure this on delivery. It is recommended that you permit the dealer to go through the operating instructions with you.

Due to the possible settling in of new components, it is essential that after a short period of use all securing nuts and bolts be checked and tightened if necessary.

## GUARANTEE

The machine is guaranteed against faulty workmanship and materials for a period of 12 months from the date of purchase. In the case of components not manufactured by Hayters PLC, no guarantee is given but the purchaser shall be entitled to the benefit of any guarantee given by the manufacturers of such components. Any claim under guarantee should be referred to the Agent through whom the machine was originally supplied, quoting the machine serial number.

The guarantee becomes void if any parts not made or supplied by Hayters are fitted to the machine. In the case of machines being used for hiring out purposes no guarantee of any kind is given or is to be implied.

## ASSEMBLY INSTRUCTIONS

Secure the upper handlebar onto the 2 lower handlebars by insertion of round head bolts and tightening of nuts.

## OPERATING INSTRUCTIONS

See the engine manufacturers' handbook and carefully carry out the recommendations for starting the engine, ensuring that engine sump is filled to the correct level with one of the recommended grades of lubricating oils. It is most important that oil other than those grades recommended should not be used in this engine.

## MANUAL INSTRUCTIONS

Set throttle to choke position then briskly pull starting cord. After ignition set throttle at fast speed.

The engine is governed to run at the maximum speed of 3,200 rpm and this speed is obtained by setting the throttle control lever in the 'FAST' position. Should any adjustments

be made to the engine it is essential that the maximum governed speed of 3,200 rpm is strictly adhered to.

## CLUTCH LEVER (336 ONLY)

The clutch incorporates a 'fail-safe' device, i.e. the machine will only move forward whilst the clutch lever, which is situated on the handlebar is manually sustained. Release of the lever will cause the machine to stop.

## CUTTING HEIGHT ADJUSTMENT

The cutting height range is from ¾" - 3" (19-75mm). To increase the height of cut, move the height adjuster lever towards the front of machine.

## HINTS ON OPERATION



This symbol warns of potentially hazardous situations which could occur if great care is not taken when using or maintaining your machine.

The Hayter Hunter 54 is a push or self propelled machine primarily designed for lawn mowing that will also deal efficiently with runaway growth on lawns and other areas. The machine is ideal for Autumn leaf collection.

The machine is capable of giving long and efficient service, observance of the following 'Hints on Operation' will ensure this.

**Lawns:** Fit grassbag, raise cutting height to maximum (3") and cut area. This will help to predetermine the height setting for the next cut and also eliminate the possibility of 'scalping' occurring on any high spots in the lawn.

**Borders:** The inset wheels permit mowing over lawn edges. Edge grasses should be cut with edging cutters first, the cuttings will then be collected as the lawn is mown.

**Walls, Fences and other Obstructions:** The machine can be safely used to cut close up to obstructions.

**Runaway Growth on Lawns:** Set cutting height to maximum, remove grassbag and cut area. The cuttings can then be collected by fitting grassbag and working over area a second time; if cuttings are wet, leave to dry and collect later.

**Hidden Obstructions:** When mowing overgrown areas, if practicable survey the area first, removing any large items of debris. Should an obstruction be encountered whilst mowing, the attention of the user will immediately be drawn by the friction noise which is set up; draw the machine backwards without raising the front. Stop the engine and remove the spark lead, examine the cutting mechanism. If



undamaged remove the obstruction or proceed to work round it. Should however, the cutterbar be broken or badly damaged it should be replaced immediately.

**Blockage in the Discharge Chute Aperture:** Observance of the preceding 'Hints' should eliminate the possibility of a blockage occurring in the Discharge Chute Aperture, for it is usually caused by attempting to remove too much grass initially with a low cutting height setting, especially, when conditions are wet, or from allowing the grassbag to become overfilled. Remember that, whatever the conditions, it is better to cut higher and more frequently than to try to cut low at the first cutting. It is most important that the engine is stopped and the spark plug lead removed before attempting to clear a blockage or examine the cutting mechanism.



**Under Deck Cleanliness:** The underside of the mainframe casing is designed to permit the cutting mechanism to work efficiently and safely and also to provide the correct volume of air to pass through the casing to carry the cuttings through the rear aperture and into the grassbag or, alternatively, deflected downwards and on to the ground. After a period of use, and more especially when conditions are wet, grass cuttings can accumulate on the underside of the casing and if allowed to remain will eventually build up and greatly impair the efficiency of the machine. Regular cleaning of the underside of the casing by hosing or scraping off the debris will prevent this. Before attempting to clean the underside of the casing, stop the engine and remove the spark plug, the machine may then be turned on its side with the silencer uppermost.



**Grassbag:** The grassbag requires minimal attention; ensure that the interior of the grassbag is kept clean.

## MAINTENANCE

### Lubrication:

**Height Adjustment Linkage Points:** Apply a small amount of oil to the linkage and pivot points occasionally.

**Throttle Control Cable:** Apply a light application of oil to the inner cable occasionally.

**Deflector Plate:** Apply a light application of oil to the deflector plate hinge points occasionally.

**Wheels:** Remove hub cap, fill with light grease and replace, thus forcing grease into bearings. On rear wheels (Autodrive only) clean and lightly grease gears.

**Clutch Cable:** (336 only) Apply a small quantity of light oil by means of an oilcan to the inner cable at the point where the cable connects with the clutch cable bracket on upper handlebars. Oil penetration down the cable will be facilitated if the clutch lever is worked backwards and forwards as the oil is applied.

**Clutch Adjustment:** (336 only) the clutch is a cable operated plate clutch. To adjust, slacken off two locknuts at top of cable. Screw in or out threaded sleeve to leave 1/16" - 1/8" (1.5mm - 3.0mm) of free play to the inner cable. Retighten locknuts.

**Engine:** See engine manufacturers' handbook and carefully carry out the recommended instructions, paying particular attention to the lubricating instructions. Cover up the machine when not in use.

The use of an upper cylinder lubricant is recommended where the machine is infrequently used and also towards the end of the season before Winter storage. When storing the machine, disconnect the spark plug lead, remove the spark plug. Insert a small quantity of oil into the cylinder and turn the engine, by means of the recoil start, a few times to distribute the oil. Replace spark plug ensuring that the piston is at the top of its compression stroke and that both the inlet and exhaust valves are closed.

**Cutterbar:** The Hayter cutterbar is friction driven by the disched bottom plate when in use. In the event of the cutterbar striking an obstruction the cutterbar is free to move relative to the bottom plate to a new position at which it will continue to cut. Regular inspection of the cutting mechanism is recommended to ensure that the cutterbar is in good condition. Should the cutterbar be damaged to the extent that it is likely to become out of balance it should be replaced immediately, ensuring that the new cutterbar is fitted exactly as shown in Figs. 1 & 3 and that the retaining setscrews, item nos. 19 & 31 are tightened securely, a torque setting of 40 ft/lb is recommended. The cutterbar may be resharpened, ensuring that both cutting edges are evenly sharpened to maintain the balance.



It is important, when examining, cleaning or making any adjustment to the cutting mechanism that the engine be stopped and the plug lead disconnected.

Fig. 1 335 MAINFRAME ASSEMBLY

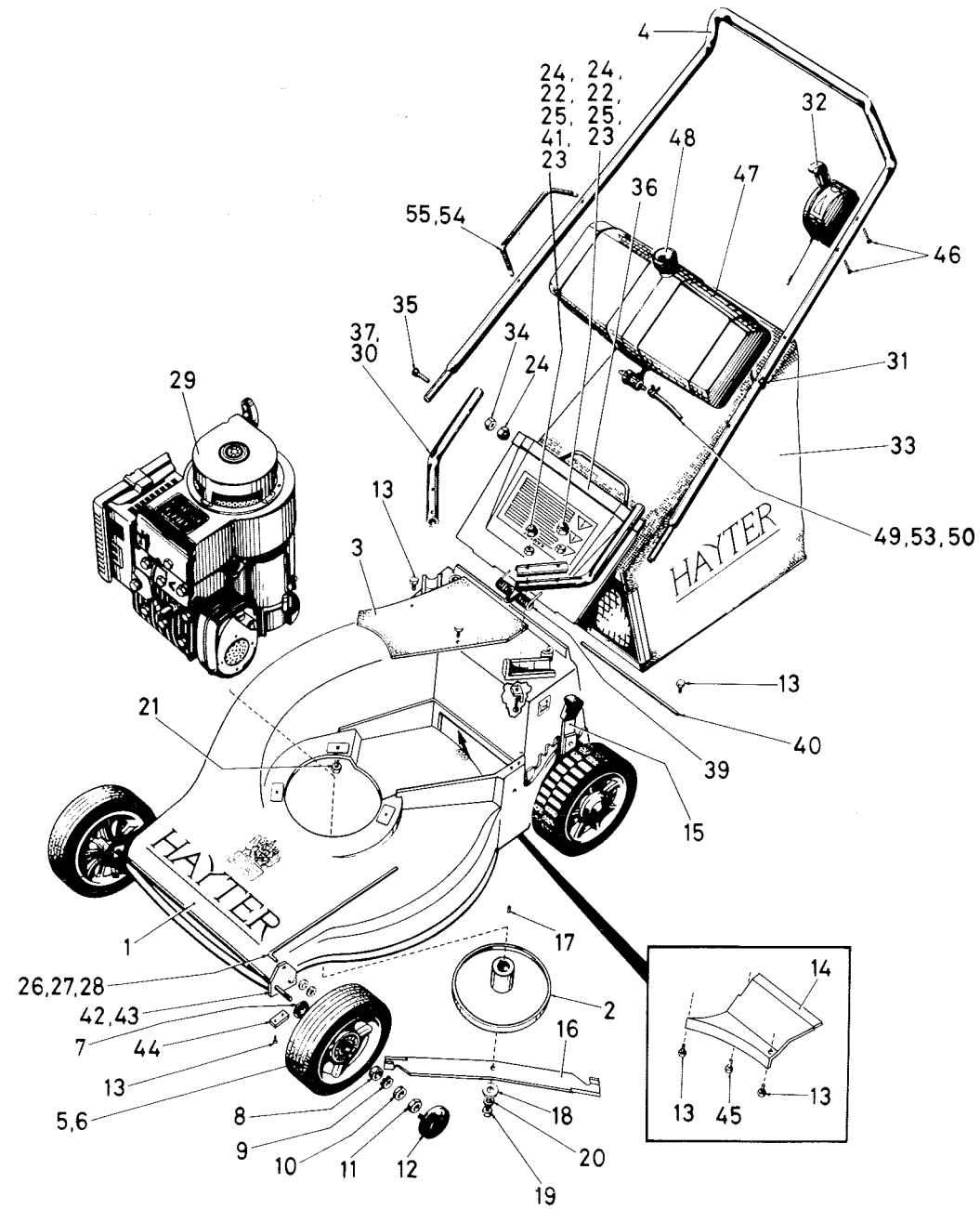

**SPARE PARTS LIST**

(Subject to revision without notice)

**FROM MACHINE NUMBER 335 001001**

All spares must be ordered through an authorised Hayter Agent.

When ordering spares please quote the SERIAL NUMBER of your machine and the PART NUMBER, not the ITEM NUMBER, of the required part.

Item No.	Part No.	No. Off	Description	Item No.	Part No.	No. Off	Description
1	330010	1	Mainframe.	29	335011	1	Engine-Briggs & Stratton 5 H.P. I/C.
2	330015	1	Friction Disc Assembly.				
3	330027	1	Transmission Cover.	30	330031	1	Lower Handlebar N/S.
4	325025	1	Upper Handlebar.	31	3966	2	Cable Tie.
5	320050	2	Front-Wheel Complete.	32	335012	1	Throttle Control & Cable.
6	320051	2	Front Wheel	33	330040	1	Grassbag Assy
7	320053	2	Dust Cover.	34	09443	2	M8 Nut.
8	320055	4	Bearing Cup.	35	322011	2	M8 × 30 Bolt.
9	320056	4	Ball Race.	36	330018	1	Grass Deflector.
10	320054	4	Bearing Cone.	37	330030	1	Lower Handlebar O/S.
11	09450	2	M10 × Selflock Nut.	38			
12	320052	2	Hub Cap.	39	320016	1	Deflector Spring.
13	09365	10	M6 × 16 Hex. Washer HD. Taptite Screw.	40	330019	1	Hinge Rod.
14	330012	1	Throwplate.	41	330025	1	Bracket.
15	330050	1	Height Adjuster Lever.	42	335015	1	Front Axle Assy.
16	330032	1	Cutterbar.	43	219036	2	Front Axle Bearing.
17	4522	1	Key - Plain Parallel	44	219037	2	Retaining Plate.
18	4014	1	Distance Piece.	45	09575	1	M6 × 20 Hex. Washer HD. Taptite Screw.
19	09116	1	3/8" UNF. × 1 1/4" Hex. HD. Screw.	46	09600	2	Pan. HD. Screw.
20	09273	1	3/8" Spring Washer S/C.	47	320025	1	Fuel Tank.
21	09349	3	3/8" UNC × 1 1/4" Taptite Screw.	48	320026	1	Tank Cap.
22	09441	4	M8 Selflock Nut 'T'-Type.	49	320027	1	Tap.
23	09379	4	M8 × 40 Carriage Bolt.	50	322015	1	Fuel Pipe.
24	234051	6	M8 Nut Cap.	51			
25	320043	2	Lower Handlebar Clamp.	52			
26	330043	1	Connecting Rod.	53	322018	2	Clip.
27	09479	1	10mm Plain Washer.	54	320023	2	Spring for Tank.
28	320062	2	10mm Spring Retainer.	55	320024	2	Spring Sleeve.

Fig. 2. 335 REAR AXLE ASSEMBLY

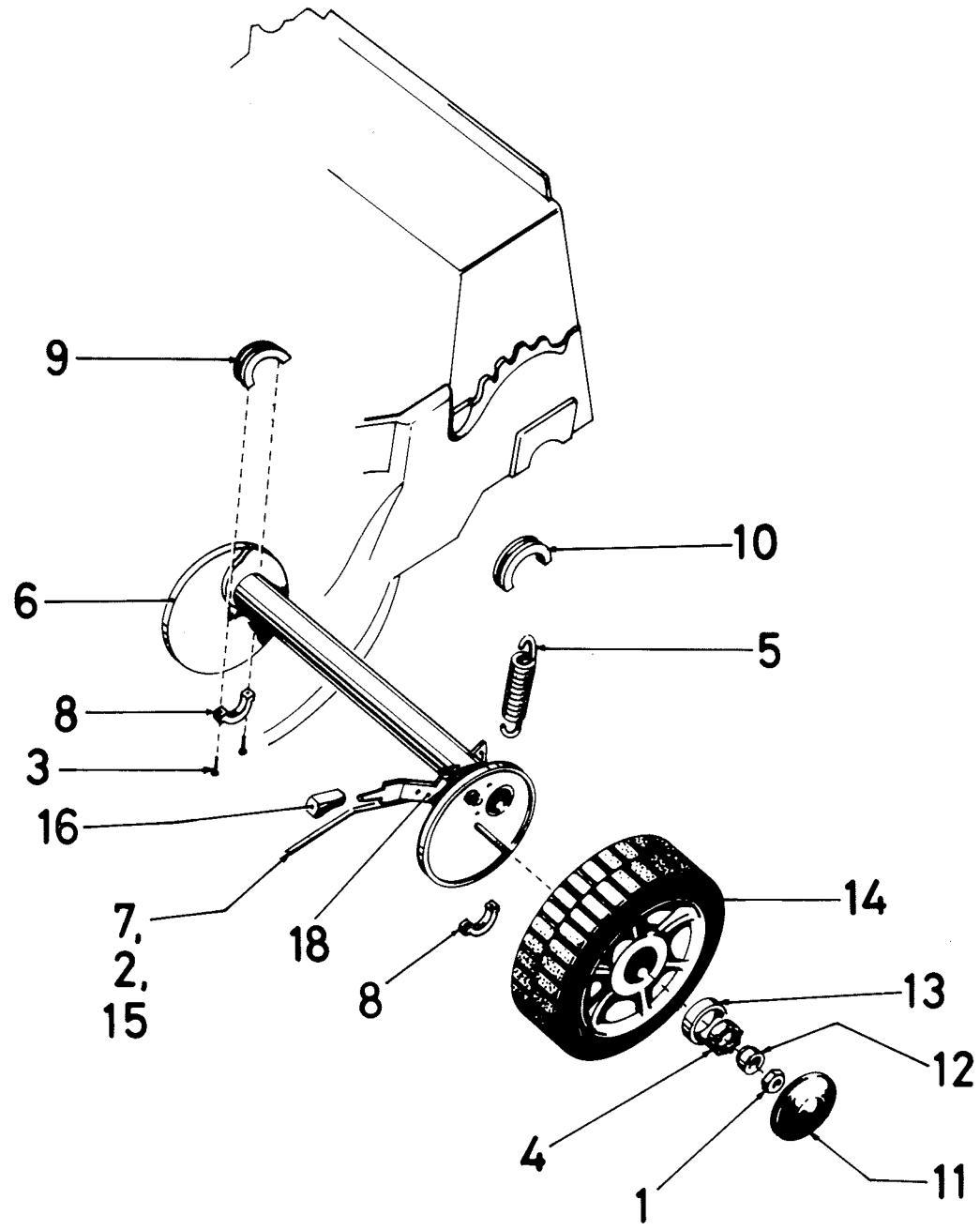

**SPARE PARTS LIST**

(Subject to revision without notice)

**FROM MACHINE NUMBER 335 001001**

All spares must be ordered through an authorised Hayter Agent.

When ordering spares please quote the SERIAL NUMBER of your machine and the PART NUMBER, not the ITEM NUMBER, of the required part.

Item No.	Part No.	No. Off	Description
1	<b>09450</b>	2	M10 Selflock Nut.
2	<b>09479</b>	1	M 10 Plain Washer.
3	<b>09575</b>	4	M6 × 20 Hex. Washer HD. Taptite Screw.
4	<b>320056</b>	4	Ball Race.
5	<b>300070</b>	1	Spring.
6	<b>330020</b>	1	Rear Axle Assembly. Less Lever, Rivets & Handle.
7	<b>330043</b>	1	Connecting Rod.
8	<b>320044</b>	2	Rear Axle Retainer.
9	<b>320045</b>	1	Bearing Half (R/H).
10	<b>320046</b>	1	Bearing Half (L/H).
11	<b>320052</b>	2	Hub Cap.
12	<b>320054</b>	4	Bearing Cone.
13	<b>320055</b>	4	Bearing Cup.
14	<b>320061</b>	2	Rear Wheel Only
15	<b>320062</b>	1	Spring Retainer.
16	<b>330053</b>	1	Lever Knob.
17			
18	<b>330026</b>	1	Rear Axle C/W Height Adjuster Lever.





**SPARE PARTS LIST**

(Subject to revision without notice)

**FROM MACHINE NUMBER 336 001001**

All spares must be ordered through an authorised Hayter Agent.

When ordering spares please quote the SERIAL NUMBER of your machine and the PART NUMBER, not the ITEM NUMBER, of the required part.

Item No.	Part No.	No. Off	Description	Item No.	Part No.	No. Off	Description
1	<b>330010</b>	1	Mainframe.	39	<b>09479</b>	2	10mm Plain Washer.
2	<b>321011</b>	1	Clutch Cable Assy.	40	<b>320062</b>	2	10mm Spring Retainer.
3	<b>321012</b>	1	9mm × 12mm Bush.	41	<b>335011</b>	1	Engine-Briggs & Stratton 5 H.P. I/C.
4	<b>321013</b>	1	Clevis Pin.	42	<b>330031</b>	1	Lower Handlebar N/S.
5	<b>321014</b>	1	Cable Guide.	43	<b>3966</b>	2	Cable Tie.
6	<b>321015</b>	1	Jockey Arm Assy.	44	<b>335012</b>	1	Throttle Control & Cable.
7	<b>321020</b>	1	Jockey Pulley.	45	<b>226034</b>	2	5/16" Bush (Nylon).
8	<b>321021</b>	2	Spacer.	46	<b>330040</b>	1	Grassbag Assy.
9	<b>331015</b>	1	Friction Disc Assy.	47	<b>09443</b>	2	M8 Plain Nut.
10	<b>321033</b>	1	Cable Retaining Plate.	48	<b>322011</b>	2	M8 × 30 Round HD. Bolt.
11	<b>336006</b>	1	Spacer.	49	<b>330018</b>	1	Grass Deflector.
12	<b>330027</b>	1	Transmission Cover.	50	<b>330030</b>	1	Lower Handlebar O/S.
13	<b>321037</b>	1	Tension Spring.	51			
14	<b>326015</b>	1	Upper Handlebar.	52	<b>320016</b>	1	Grass Deflector Spring.
15	<b>321042</b>	1	Spring Retainer.	53	<b>330019</b>	1	Hinge Rod.
16	<b>331019</b>	1	V-Belt.	54	<b>330025</b>	1	Bracket.
17	<b>320050</b>	2	Wheel-Complete Front.	55	<b>335015</b>	1	Front Axle Assy.
18	<b>320051</b>	2	Wheel-Front.	56	<b>219036</b>	2	Front Axle Bearing.
19	<b>320053</b>	2	Dust Cover.	57	<b>219037</b>	2	Retaining Plate.
20	<b>320055</b>	4	Bearing Cup.	58	<b>6277</b>	1	Bearing.
21	<b>320056</b>	4	Ball Race.	59	<b>09263</b>	1	1/4" Plain Washer.
22	<b>320054</b>	4	Bearing Cone.	60	<b>320011</b>	1	Engine Spacer.
23	<b>09450</b>	2	M10 Selflock Nut.	61	<b>09546</b>	1	M6 × 12 Hex. Washer HD. Taptite Screw.
24	<b>320052</b>	2	Hub Cap.	62	<b>219090</b>	1	Clutch Lever.
25	<b>09365</b>	13	M6 × 16 Hex. Washer HD. Taptite Screw.	63	<b>09600</b>	2	Pan HD. Screw.
26	<b>330011</b>	1	Throwplate.	64	<b>09575</b>	1	M6 × 20 Hex. Washer HD. Taptite Screw.
27	<b>330050</b>	1	Height Adjuster Lever.	65	<b>09592</b>	1	M6 × 25 Hex. Washer HD. Taptite Screw.
28	<b>330032</b>	1	Cutterbar.				
29	<b>4522</b>	1	Key-Plain Parallel.	66			
30	<b>4014</b>	1	Distance Piece.	67			
31	<b>09121</b>	1	3/8" UNF. × 2" Hex. HD. Bolt.	68	<b>320026</b>	1	Cap.
32	<b>09273</b>	1	3/8" Spring Washer S/C.	69	<b>322018</b>	2	Fuel Pipe Clip.
33	<b>09591</b>	3	3/8" UNC × 2" Hex. Washer HD. Duo Taptite Screw.	70	<b>320023</b>	2	Spring for Tank.
34	<b>09441</b>	4	M8 Selflock Nut 'T'-Type.	71	<b>320024</b>	2	Spring Sleeve.
35	<b>09379</b>	4	M8 × 40 Carriage Bolt.	72	<b>320027</b>	1	Tap.
36	<b>234051</b>	6	M8 Nut Cap.	73	<b>322015</b>	1	Fuel Pipe.
37	<b>320043</b>	2	Lower Handlebar Clamp.	74	<b>320025</b>	1	Fuel Tank.
38	<b>330043</b>	1	Connecting Rod.				

Fig. 4. 336 REAR AXLE ASSEMBLY

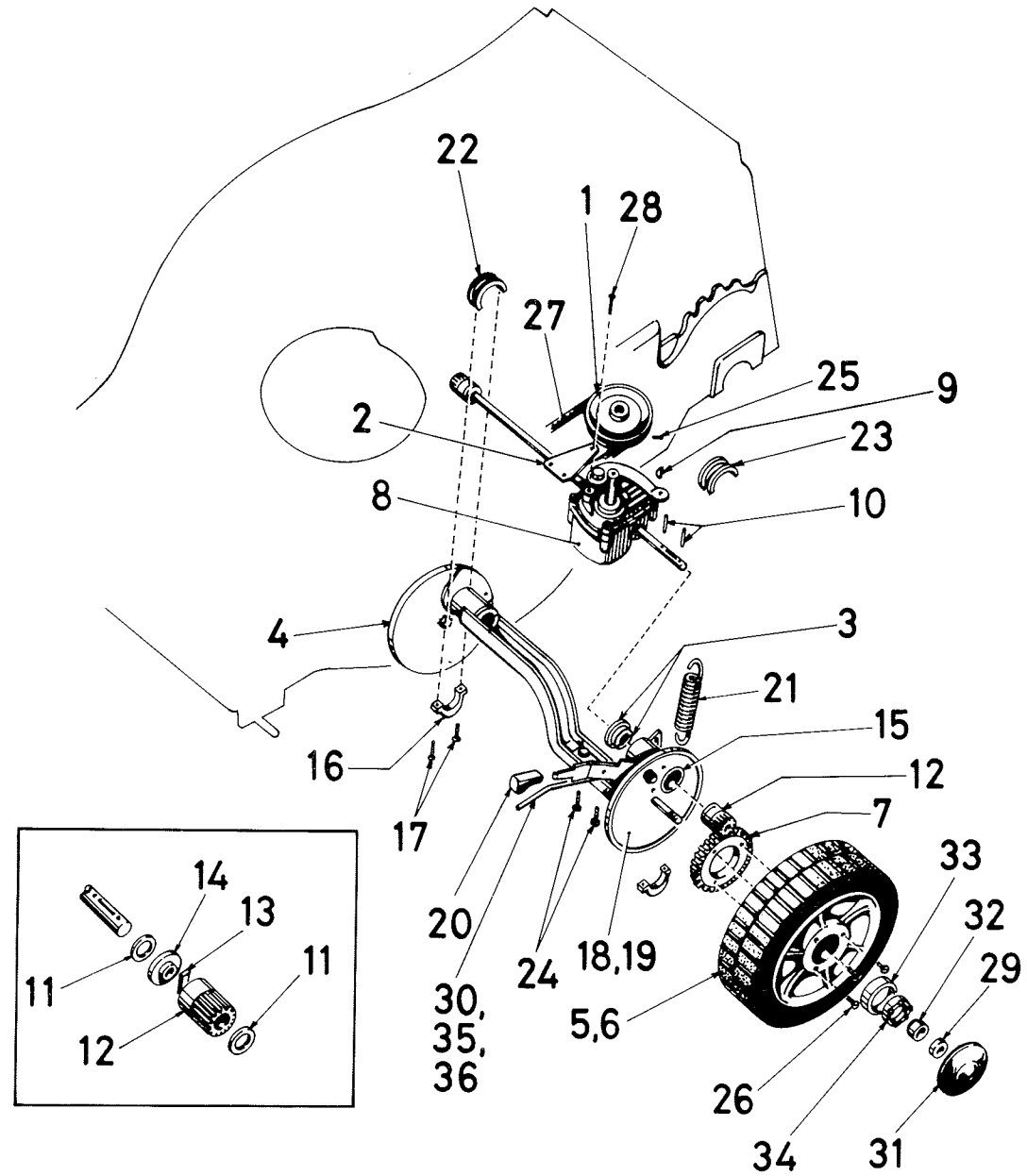

**SPARE PARTS LIST**

(Subject to revision without notice)

**FROM MACHINE NUMBER 336 001001**

All spares must be ordered through an authorised Hayter Agent.

When ordering spares please quote the SERIAL NUMBER of your machine and the PART NUMBER, not the ITEM NUMBER, of the required part.

Item No.	Part No.	No. Off	Description	Item No.	Part No.	No. Off	Description
1	<b>321026</b>	1	Pulley.	19	<b>331025</b>	1	Rear Axle N/S.
2	<b>321030</b>	1	Torque Arm.	20	<b>330053</b>	1	Spring Lever Cover.
3	<b>321035</b>	4	Half Seal.	21	<b>300070</b>	1	Compensator Spring.
4	<b>331020</b>	1	Rear Axle Assy. (Long)	22	<b>320045</b>	1	Bearing Half O/S.
5				23	<b>320046</b>	1	Bearing Half N/S.
6	<b>321046</b>	2	Rear Wheel Only	24	<b>3466</b>	2	M8 × 16 Hex. HD. Screw.
7	<b>321047</b>	2	Gear.	25	<b>09594</b>	1	M6 × 6 Socket Set Screw.
8	<b>331030</b>	1	Gearbox.	26	<b>09593</b>	6	M6 × 35 C/SK. HD. Screw.
9	<b>321051</b>	1	Woodruff Key.	27	<b>331019</b>	1	V-Belt.
10	<b>321052</b>	2	Roll Pin.	28	<b>09595</b>	1	M5 × 12 Hex. Washer HD. Taptite Screw.
11	<b>321053</b>	4	Thrust Washer.				
12	<b>321054</b>	2	Gear.	29	<b>09450</b>	2	M10 Selflock Nut.
13	<b>321055</b>	2	Pawl.	30	<b>330043</b>	1	Connecting Rod.
14	<b>321056</b>	2	Spacer (Nylon)	31	<b>320052</b>	2	Hub Cap.
15	<b>321057</b>	2	Bearing.	32	<b>320054</b>	2	Bearing Cone.
16	<b>320044</b>	2	Rear Axle Retainer.	33	<b>320055</b>	2	Bearing Cup.
17	<b>09575</b>	4	M6 × 20 Hex. Washer HD. Taptite Screw.	34	<b>320056</b>	2	Ball Race.
18	<b>331028</b>	1	Rear Axle N/S. C/W Height Adj. Lever & Cover.	35	<b>09479</b>	1	10mm Plain Washer.
				36	<b>320062</b>	1	Spring Retainer.

### WARNING NOTICE

(Issued in accordance with Asbestos Products (Safety) Regulations 1986)  
Certain components on this Mower, such as brake and clutch linings and some gaskets and joints, may contain a small quantity of asbestos.

When repairing and replacing these items care should be taken to:-

- 1) Carry out the repairs in a well ventilated area.
- 2) Remove dust by dampening down using a recommended liquid or water.
- 3) Dampen dust and place it in a properly closed receptacle.
- 4) Dispose of the receptacle safely.

If you are uncertain seek advice from your dealer.

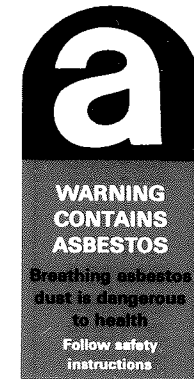

**PART NUMBER 335002**  
**January 1988**