

Electrolux

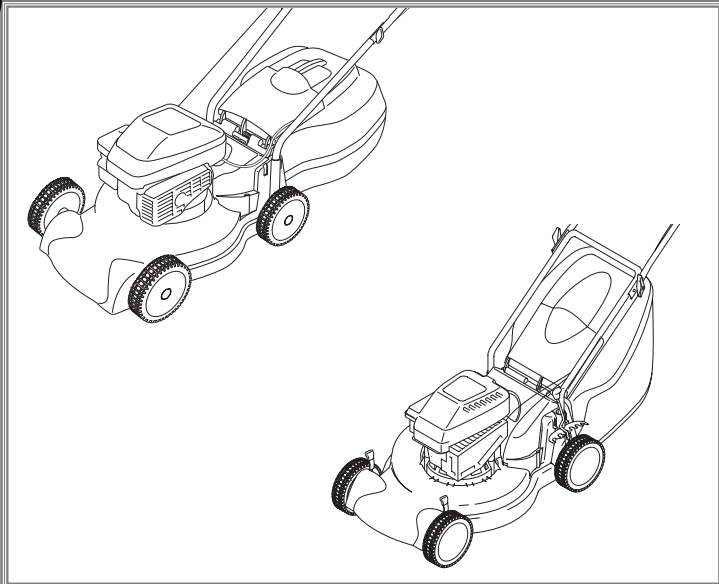

PETROL WHEELED ROTARY LAWNMOWER

SICHELMÄHER MIT BENZINMOTOR

TONDEUSE THERMIQUE

CORTACÉSPED ROTATIVO DE GASOLINA A RUEDAS

TOSAERBA A SCOPPIO CON RUOTE

BENZINE WIELMAAIER

HJULGÅENDE, BENSINDREVET ROTORGRESSKLIPPER

BENSIINIKÄYTTÖINEN RUOHONLEIKKURI

GRÄSKLIPPARE MED HJUL OCH BENSINMOTOR

BENZINDREVET ROTORPLÆNEKLIPPER PÅ HJUL



Please Note :- This manual covers various products. Please read the user instructions carefully to fully identify, assemble and use the features that apply to your petrol wheeled rotary lawnmower

Hinweis: Dieses Handbuch ist für verschiedene Produkte bestimmt. Diese Betriebsanleitung muß sorgfältig durchgelesen und die einzelnen Bestandteile, die auf Ihren Rasenmäher zutreffen, identifiziert, zusammengesetzt und verwendet werden.

Note: Ce manuel couvre plusieurs appareils. Veuillez lire attentivement les instructions pour identifier, assembler et utiliser les pièces de votre tondeuse thermique

Nota:- Este manual cubre varios productos. Lea cuidadosamente las instrucciones del usuario para identificar totalmente, ensamblar y utilizar las características aplicables a su cortacésped rotativo de gasolina a ruedas.

Si prega di voler notare che questo manuale si occupa di vari prodotti. Si prega di voler leggere con attenzione le istruzioni d'uso per identificare, montare e usare a fondo le caratteristiche corrispondenti al vostro tosaerba a scoppio rotativo con ruote.

Let op: In deze handleiding worden verschillende producten beschreven. U dient de handleiding dan ook in zijn geheel grondig door te lezen voor identificatie, montage en het juiste gebruik van de voorzieningen die van toepassing zijn op uw Benzine Wielmaaier.

OBS! Denne håndboken omhandler ulike typer gressklippere. Les bruksanvisningen nøye, slik at du kan identifisere, montere og bruke den klipperen du har kjøpt.

Huom: Tämä käyttöohje kattaa useita tuotteita. Lue ohje huolella, jotta varmasti tunnistat oman koneesi, osat koota sen ja voit hyvin käyttää leikkurisi ominaisuuksia hyödyesesi.

OBS: Denna handbok behandlar olika produkter. Läs bruksanvisningen omsorgsfullt så att du har fullt klart för dig vilken maskin det gäller, hur du sätter samman den och hur du använder de olika funktionerna på din gräsklippare med hjul och bensinmotor.

Bemærk: Denne manual gælder for flere forskellige produkter. Læs brugsvejledningen nøje for at identificere, samle og anvende de enheder, som er relevante for Deres benzindrevne rotorplæneklipper.

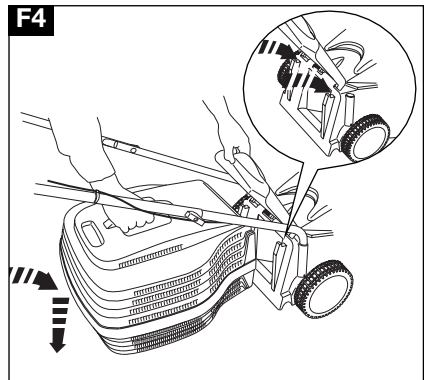
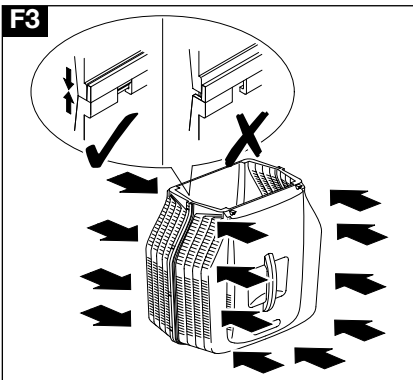
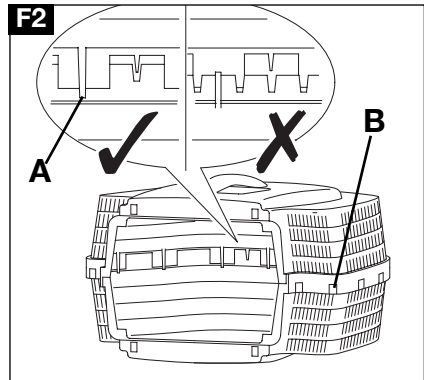
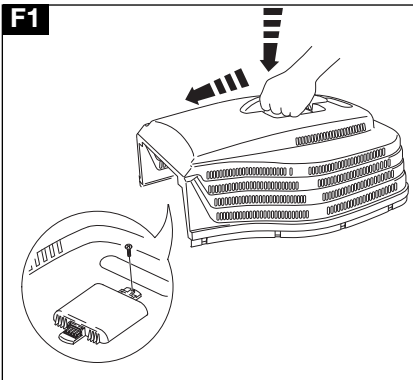
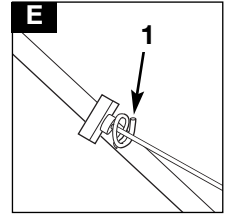
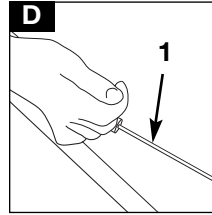
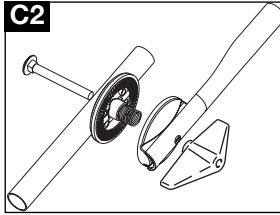
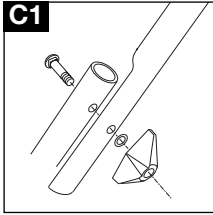
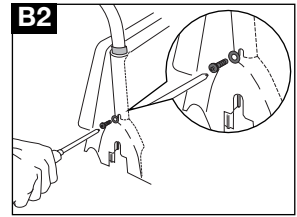
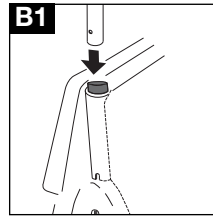
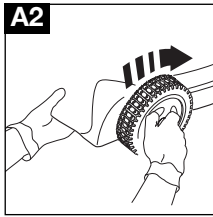
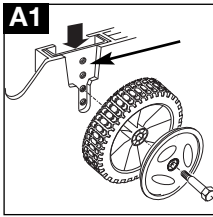

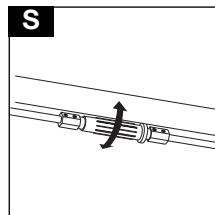
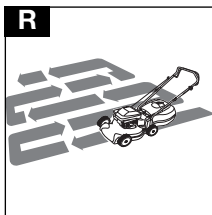
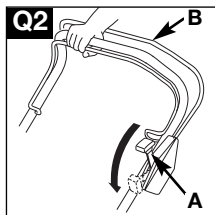
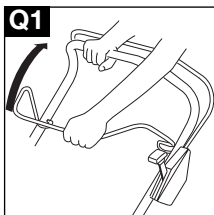
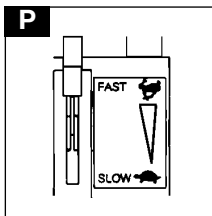
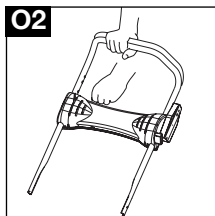
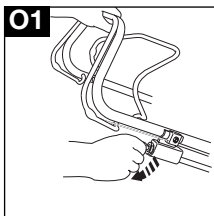
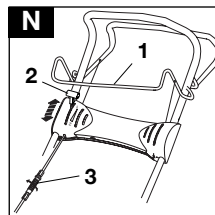
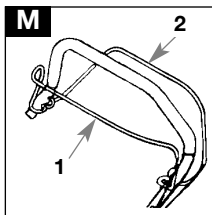
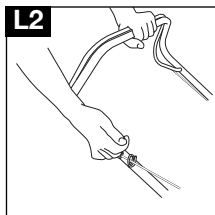
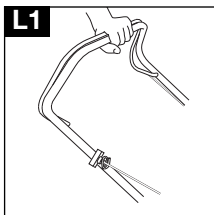
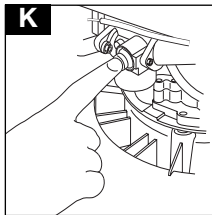
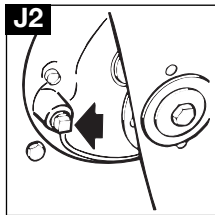
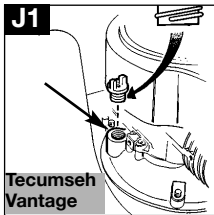
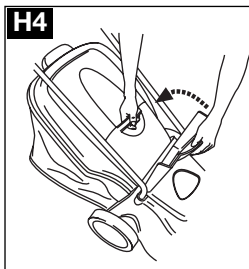
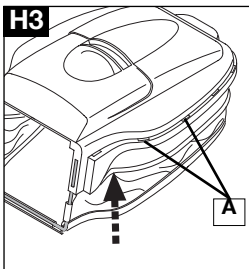
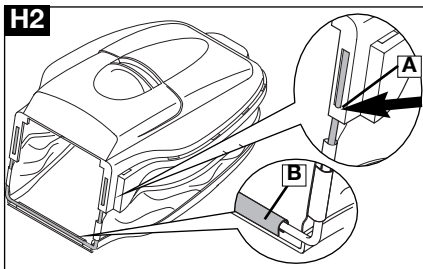
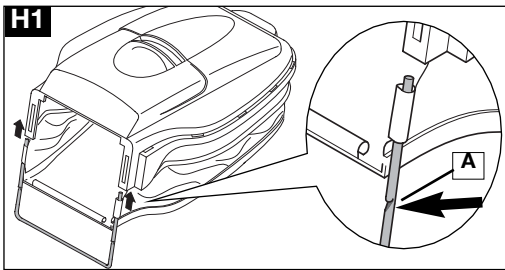
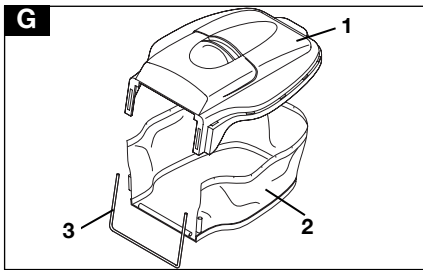

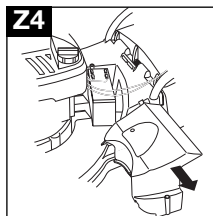
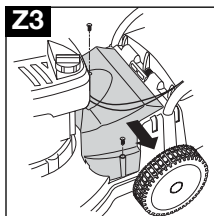
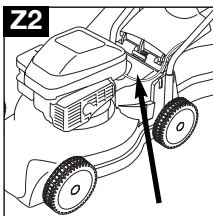
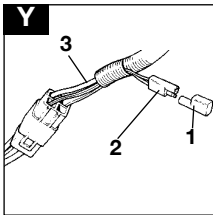
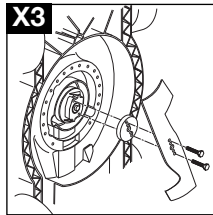
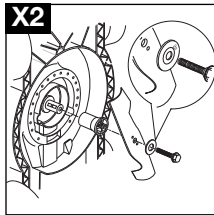
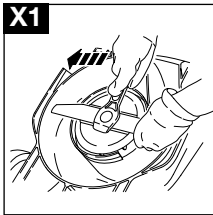
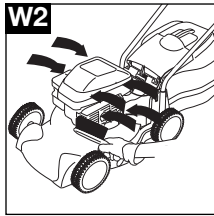
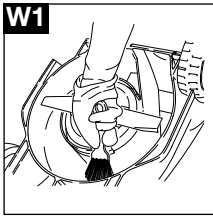
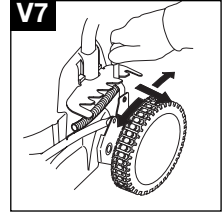
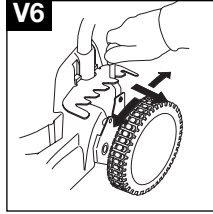
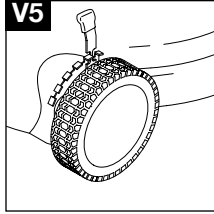
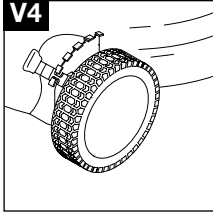
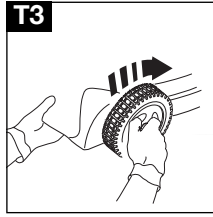
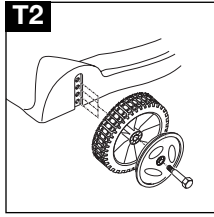
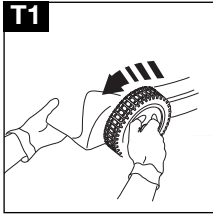

SAFETY PRECAUTIONS



If not used properly this lawnmower can be dangerous! This lawnmower can cause serious injury to the operator and others, the warnings and safety instructions must be followed to ensure reasonable safety and efficiency in using this lawnmower. The operator is responsible for following the warning and safety instructions in this manual and on the lawnmower. Never use the mower unless the grassbox or guards provided by the manufacturer are in the correct position.

Explanation of Symbols on the Petrol Wheeled Rotary Lawnmower



Warning



Read the user instructions carefully to make sure you understand all the controls and what they do.



Always keep the lawnmower on the ground when mowing. Tilting or lifting the lawnmower may cause stones to be thrown out.

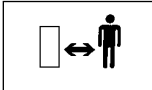

Keep bystanders away. Do not mow whilst people especially children or pets are in the mowing area.



Beware of severing toes or hands. Do not put hands or feet near a rotating blade.



Disconnect the spark plug before attempting any maintenance, cleaning or adjustment, or if you are going to leave the lawnmower unattended for any period.



Blade continues to rotate after the machine is switched off. Wait until all machine components have completely stopped before touching them.

General

1. Never allow children or people unfamiliar with these instructions to use the mower. Local regulations may restrict the age of the operator.
2. Only use the lawnmower in the manner and for the functions described in these instructions.
3. Never operate the lawnmower when you are tired, ill or under the influence of alcohol, drugs or medicine.
4. The operator or user is responsible for accidents or hazards occurring to other people or their property.

Fuel Safety

WARNING - Petrol is highly flammable

- Wear protective clothing when handling any fuels and lubricants.
- Avoid contact with skin. If affected, wash liberally with soap and water.
- Remove petrol and engine oil before transporting the product.
- Store fuel in a cool place in a container specifically designed for the purpose. In general plastic containers are unsuitable

- refuel outdoors only and do not smoke while refuelling
- add fuel **BEFORE** starting the engine. Never remove the cap of the fuel tank or add fuel while the engine is running or when the engine is hot
- if petrol is spilled, do not attempt to start the engine but move the machine away from the area of spillage and avoid creating any source of ignition until petrol vapours have dissipated
- replace all fuel tanks and container caps securely
- move the product away from the fuelling area before starting
- Fuel should be stored in a cool place away from naked flames

Preparation

1. Do not mow barefoot or in open sandals. Always wear suitable clothing, gloves, and stout shoes.
2. The use of ear protection is recommended.
3. Make sure the lawn is clear of sticks, stones, bones, wire and debris; they could be thrown by the blade.
4. Before using the machine and after any impact, check for signs of wear or damage and repair as necessary.
5. Replace worn or damaged blades together with their fixings in sets to preserve balance.
6. Have faulty silencers replaced.

Use

1. Do not operate the engine in a confined space where exhaust fumes (carbon monoxide) can collect.
2. Use the lawnmower only in daylight or good artificial light.
3. Avoid operating your lawnmower in wet grass, where feasible.
4. Take care in wet grass, you may lose your footing.
5. On slopes, be extra careful of your footing and wear non-slip footwear.
6. Mow across the face of slopes, never up and down.
7. Exercise extreme caution when changing direction on slopes.
8. Mowing on banks and slopes can be dangerous. Do not mow on **banks** or **steep** slopes.
9. Do not walk backwards when mowing, you could trip. Walk, never run.
10. Never cut grass by pulling the mower towards you.
11. Release the Operator Presence control (**OPC**) to stop the engine before pushing the mower across surfaces other than grass and when transporting the lawnmower to and from the area to be mowed.
12. Never operate the lawnmower with damaged guards or without guards in place.

SAFETY PRECAUTIONS

13. Do not overspeed the engine or alter governor settings. Excessive speed is dangerous and shortens lawnmower life.
 14. Disengage all blade and drive clutches before starting. (page 6)
 15. Keep hands and feet away from the cutting means at all times and especially when switching on the motor.
 16. Do not tilt lawnmower when starting the engine
 17. Do not put hands near the grass discharge chute whilst engine is running.
 18. Never pick up or carry a lawnmower while the engine is running
 19. Spark plug wire may be hot - handle with care.
 20. Do not attempt any maintenance on your lawnmower when the engine is hot.
 21. Release the Operator Presence Control, to stop the engine, and wait until the blade has stopped:-
 - before leaving the mower unattended for any period;
 22. Release the Operator Presence Control, to stop the engine, wait until the blade has stopped, disconnect the spark plug lead and wait until the engine has cooled:-
 - before refuelling
 - before clearing a blockage;
 - before checking, cleaning or working on the appliance;
 - if you hit an object. Do not use your lawnmower until you are sure that the entire lawnmower is in a safe operating condition.;
 - if the lawnmower starts to vibrate abnormally. Check immediately. Excessive vibration can cause injury.
23. Reduce the throttle setting during engine shut down and, if the engine is provided with a shut-off valve, turn the fuel off at the conclusion of mowing.

Maintenance and storage

1. Keep all nuts, bolts and screws tight to be sure the lawnmower is in safe working condition.
2. Check the grassbox/grassbag frequently for wear or deterioration.
3. Replace worn or damaged parts for safety.
4. Only use the replacement blade, blade bolt, spacer and impeller specified for this product.
5. Never store the lawnmower with fuel in the tank inside a building where fumes can reach an open flame or spark.
6. Allow the engine to cool before storing in any enclosure.
7. To reduce fire hazard, keep the engine, silencer, battery compartment and fuel storage area free of grass, leaves or excessive grease.
8. If the fuel tank has to be drained, this should be done outdoors.
9. Be careful during adjustment of the machine to prevent entrapment of the fingers between the blade and fixed parts of the machine.

ASSEMBLY INSTRUCTIONS

WHEEL ASSEMBLY (WHERE NECESSARY)

1. Select one of the holes in the mounting plate and note its position, as all four wheels will need to be adjusted to the same position (A1).
2. Locate the fixing bolt through hole in hub cap, wheel and selected hole in mounting plate.
3. Turn the wheel hub in a clockwise direction until the wheel assembly is securely located to the deck (A2).

HANDLES

Lower Handles

1. If your product has Cutting Height with levers (see Adjustment, page 5), ensure the lever is at the Highest Cut Height before following steps 2 & 3.
2. Insert each side of the lower handle into deck as shown in Fig B1.
3. Push each side of the handle firmly down until it is located securely into the deck (B2).
4. Insert screw through the washer and into holes using a pozidrive screwdriver and tighten fully into deck as shown in Fig B2.

Upper Handles

1. Fit the upper handle to the lower handle with the bolts, washers and handle knobs. (C1)
2. Fit the cables to the handles with the cable ties provided, making sure the cables are not trapped between the upper and lower handles.

Handle Adjusters fitted to product

1. Adjust handle assembly to the most comfortable operating position and tighten handle adjuster knob (C2) on both sides of the product.

ASSEMBLY INSTRUCTIONS

RECOIL STARTER

- **You must release the brake by pulling the OPC lever to the handle before pulling out the cord.**

1. Disconnect the spark plug lead.
2. Pull the OPC lever to release the brake on the engine.

3. Extend the pull cord fully (**D1**).
4. Locate the cord in the pull cord guide positioned on handle (**E1**).

GRASSBOX ASSEMBLY - PLASTIC BOX

Please Note Ensure no gap remains between the safety flap and the grassbox/bag

Where grass collection is not required you can use the lawnmower without the grassbox/bag. Ensure the safety flap is fully closed

1. Insert the grassbox handle into the top of one of the grassbox halves. Press firmly down and forward until the handle clicks into position (**F1**)
2. Turn the grassbox half over and insert screw into hole (as illustrated in fig **F1**) and tighten fully.
3. Position the two grassbox halves together and press each location point (**F2-A**) into position **without** fully connecting the clips. When the location points are matched correctly firmly press the grassbox together until all clips are securely connected. (**F2-B**)
4. To attach the grassbox to your lawnmower, lift the safety flap (**F3**) and make sure the discharge chute is clean and free from debris.
5. Locate fully assembled grassbox onto 2 location points at the rear of the deck **F4**.
6. Locate safety flap onto the top of the grassbox. Ensure the grassbox is securely located.
 - Removal is the reverse procedure.

GRASSBOX ASSEMBLY - FABRIC BAG

G1 - Top

G2 - Fabric Bag

G3 - 'U' Frame

1. Insert 'U' frame through side sleeves of fabric bag and then into the hard top, ensuring the small metal pip (**H1-A**) is securely located (**H2-A**).
2. Attach lower sleeve of fabric bag to 'U' frame (**H2-B**).
3. Starting at front end of the top (**H3**), insert the fabric bag rim into the inside edge of the top until it clicks into each of the location points (**H3-A**). Keep inserting the rim around the top until the fabric bag is secure.
4. Locate fully assembled grassbox onto 2 location points at the rear of the deck.
5. Locate safety flap onto the top of the grassbox (**H4**). Ensure the grassbox is securely located.
 - Removal is the reverse procedure

ENGINE NOTES

Oil

1. To fill with oil:-
 - a) Remove oil filler cap.
 - b) Fill to the FULL mark on the dipstick.
2. Use a good quality SAE 30 four stroke oil.
3. Check oil level periodically and after every five hours of operation.
4. Add oil as necessary to keep the level to the FULL mark on the dipstick.
5. Change the oil after the first **five hours** operation and thereafter every 25 working hours.
6. Always change the oil while the engine is warm - but not hot - never attempt any maintenance on a hot engine.

Petrol

1. Use fresh regular grade lead free petrol.
2. **NEVER use leaded petrol.**

Using leaded petrol will make the exhaust smoke and cause irreparable damage to engines fitted with a catalytic converter.
3. Do not fill the fuel tank when the engine is hot.
4. Do not fill the fuel tank while smoking.
5. Do not fill the fuel tank while the engine is running.
6. To avoid introducing dirt into the fuel system, wipe all grass and dirt from the petrol filler cap before unscrewing it.

7. It is recommended that you fill the tank through a funnel with a filter.
8. Wipe away spillages before starting.

Tecumseh Vantage Only

To fill with oil

- **Oil Capacity: 1 pint (0.6 litre)**
 - a. Unscrew the oil filler plug.
 - b. Remember to pour the oil slowly.
 - c. Fill to the overflow point in the oil fill hole (**J1**).
 - d. Install oil fill plug. Tighten securely.
- Change oil after the first **2 hours** of operation and then after every 25 working hours.

To drain oil.

- Disconnect spark plug and allow engine exhaust to cool.
- Turn machine on its side with the exhaust uppermost.
- Remove drain plug (**J2**).
- Place suitable container under product.
- Turn machine back on its wheels and the oil will drain into the container.

STARTING - PRIMING

Please Note:- When starting the engine for the first time, fill with oil and petrol as described above in the **Oil and Petrol** section.

Priming is usually unnecessary when restarting a warm engine. However, cool weather may require priming to be repeated.

Briggs and Stratton Engines

1. Advance throttle to FAST or RUN as illustrated in **Throttle Control** section.
2. Push primer bulb (**K**) firmly five times
3. Following instructions in the **Use - starting and stopping** section.
4. If engine fails to start after three pulls of the pull cord, push primer bulb three times and repeat step 3.

Tecumseh Engines

1. Move throttle control to FAST or RUN position
2. Push primer three times. Wait about two seconds between each push. In cold weather (55°F/13°C or below) push primer five times.

3. Following instructions in the **Use - starting and stopping** section.

- **DO NOT USE PRIMER TO RESTART WARM ENGINE.**

Starting engine thereafter

1. Move throttle control (if fitted) to RUN or FAST position and push primer bulb firmly three times before starting engine. (if engine stopped because it ran out of fuel, refuel engine - push primer bulb three times.

USE

STARTING AND STOPPING

PUSH

Please Note : Your upper handles may look different from those shown but the procedure remains the same

1. Connect the spark plug lead.
2. If fitted move the throttle control to the FAST  position.
3. Pull the OPC to the handle (**L1**), this releases the brake.

4. Pull the recoil starter fully towards you until you feel the full resistance, return the handle slowly then pull the handle firmly towards you to its full extent (**L2**).
5. After the engine has started, allow to run for 30 seconds before commencing to use.

To stop your lawnmower - release the OPC lever

POWERDRIVE

1. Follow the above procedure for **Push** lawnmowers
2. Forward drive is engaged and disengaged with the Powerdrive lever at the top of the handle (**M1**).

3. Releasing the Powerdrive Lever stops the forward drive automatically.

To stop your lawnmower - release the Powerdrive lever, then the OPC lever (**M2**)

DUAL SPEED

Before starting the engine for the first time, ensure free movement of the rear wheels by moving the machine backwards and forwards without operating the powerdrive lever (**N1**). Whilst moving backwards and forwards operate the gear change lever (**N2**) from low to high

speed, if the rear wheels lock, the cable will require adjusting. Adjusting is achieved by turning the adjuster (**N3**) left or right until the machine can be pulled backwards without the wheels locking.

KEY START

Key Start Only - During mowing, your engine will recharge the battery

Please note:- Your lawnmower can be started manually by following steps 1-5 in the PUSH section



The Powerdrive may be engaged by following steps 2-3 in the Powerdrive section.

1. Follow steps 1-3 for the Push lawnmower.
2. Turn the key and hold until the engine starts (**O1** and **O2**). The key will return to the original position when released.

3. If the engine fails to start when you turn the key your battery may need charging.

To stop your lawnmower - release the powerdrive lever, then the OPC lever.

THROTTLE CONTROL - IF FITTED (P)

1.  represents the FAST (run) position.
2.  represents the SLOW (idle) position.

USE

STARTING AND STOPPING

BLADE, BRAKE, CLUTCH (BBC)

If you have a BBC model you will be able to keep the engine running while the brake is on.

Forward drive is engaged and disengaged with the Power Drive lever at the top of the handle **(Q2-B)**.

1. Connect the spark plug lead.
 2. If fitted move the throttle control to the FAST position.
 3. Pull the recoil starter fully towards you until you feel the full resistance, return the handle slowly then pull the handle firmly towards you to its full extent.
 4. After the engine has started, allow to run for 30 seconds before commencing to use.
 5. Pull the BBC arm to the handle **(Q1)**.
 6. While holding the BBC arm, push forward BBC control lever until a click is heard **(Q2-A)**.
 7. Release the BBC control lever which will return to its original position.
 8. Releasing the BBC arm will stop the blade from rotating.
- Please note:**
Leaving the engine running without the blade rotating for an extended length of time could lead to the engine overheating.
- To stop the lawnmower** - release the powerdrive lever then the BBC arm. Move throttle control to stop position.

How to Mow

Please Note:-

Do not overload your Lawnmower

When mowing in long thick grass a first cut with the cutting height adjusted to its highest setting, see **Cutting Height**, will help reduce motor overload and will help prevent damage to your lawnmower.

1. Start mowing from the outside edge of the lawn, mowing in strips in alternate directions **(R)**.
2. Mow twice a week in the growing season, your lawn will suffer if more than one third of its length is cut at one time and this may also result in poor collection.

POWERDRIVE CABLE

Ensure the Powerdrive cable is not twisted and runs freely down the handles.

1. If the drive does not engage when the powerdrive lever is pulled towards the handle screw adjuster anti-clockwise **(S)**.
2. Screw adjuster in opposite direction if the powerdrive does not disengage with the powerdrive lever free **(S)**.

ADJUSTMENT

CUTTING HEIGHT (WITHOUT LEVERS)

If your lawnmower has wheel hubs as illustrated in **T1**, the height of cut is adjusted by following steps **T1- T3**.

1. Remove the wheel by turning the wheel hub in an anticlockwise direction **(T1)** and relocate in new hole **(T2)** turning the wheel hub in a clockwise direction to tighten **(T3)**. Repeat for other wheels adjusting to the same position.

CUTTING HEIGHT (WITH LEVERS)

Please Note : Your petrol wheeled rotary may be fitted with a mixture of cutting heights.

Levers Fitted, Lowest Cut Height - **(V1)**

Levers Fitted, Highest Cut Height - **(V2)**

Levers Fitted, Semi Central - **(V3)**

Levers Fitted, Central - **(V4)**

1. If you have Height of Cut levers **(Figs. V)**, the height of cut is altered by pulling the adjustment lever away from the location slots and moving to the selected position.
2. If your petrol wheeled rotary is fitted with more than one lever then these must be adjusted to the same position **(Figs V)**.

MAINTENANCE

CLEANING

IMPORTANT

Never use water for cleaning your lawnmower. Do not clean with chemical, including petrol, or solvents - some can destroy critical plastic parts.

1. Remove grass from under the deck with a brush **(W1)**.
 2. Using a soft brush - remove grass clippings from all air intakes, the discharge chute and the grass box **(W2)**.
 3. Wipe over the surface of your lawnmower with a dry cloth.
- **Disconnect spark plug and allow engine exhaust to cool.**
 - **Turn machine on its side with the exhaust uppermost.**

CUTTING SYSTEM

Always handle the blade with care - sharp edges could cause injury. USE GLOVES
Renew your metal blade after 50 hours mowing or 2 years whichever is the sooner - regardless of condition.
If the blade is cracked or damaged replace it with a new one.

Please note

If you have a machine fitted with BBC then you must remove both blade bolts **(X3)**

Removing the Blade

- **Disconnect spark plug and allow engine exhaust to cool.**
 - **Turn machine on its side with the exhaust uppermost.**
1. Use spanner to loosen blade bolt by turning anti-clockwise **(X1)**.
 2. Remove the blade bolt, blade and washer **(X2)**
 3. Inspect for damage and clean as necessary.

Fitting the Blade

1. Fit the blade to the machine with the sharp edges pointing away from the machine.
2. Re-fit the blade bolt through the washer ensuring that the side stamped with '0' on the washer is facing away from the blade **(X2)**.
3. Hold firmly and tighten blade bolt firmly with a spanner. Do not over tighten.

BATTERY SAFETY (KEY START MODELS ONLY)

Safety Procedures when Charging the Battery

1. Check the charger cable regularly for damage or deterioration due to age.
2. Do not use the lawnmower if the charging cable is not in good condition.
3. Do not attempt to charge other products with the charger from this unit.
4. Do not attempt to use this battery with any other charger.
5. Charging should only be carried out in a safe location where neither battery nor cord cable can be trodden on or tripped over.
6. Location should be well-ventilated.
7. During charging, the battery charger becomes warm. This is normal and means the charger is operating properly.
8. Do not cover the battery charger with anything during charging.
9. Ensure that neither the charger nor the battery are exposed to moisture.
10. Avoid extreme temperatures.
11. The charger will not operate below freezing point nor above 40°C.
12. Do not short circuit the battery terminals.

General Guidance on Rechargeable Battery

1. Charging time is 24 hours.
2. Under normal usage the battery will be charged during the running of the engine.
3. To keep in prime condition the battery should be charged at least once every six months.
4. Exceeding the charging period may shorten the battery life.
5. Protect electric cable. Never carry the battery charger by the electric cable only.
6. If after an extended usage period the battery quickly runs down after a full 24 hour charging period, a replacement battery is probably needed.
7. Do not attempt to open the main body casing.
8. Clean only with a dry soft cloth.
9. Never use a damp cloth or flammable liquids such as petrol, white spirits, thinners etc.
10. Dispose of old batteries safely.

MAINTENANCE

CHARGING THE BATTERY (KEY START MODELS ONLY)

IMPORTANT:-Replacement batteries will need to be charged before use.

Ensure that neither the charger nor the battery are exposed to moisture

The battery pack can be replaced by unclipping the battery from its housing and disconnecting the battery pack from the battery leads.

How to Charge the Battery

1. Stop your lawnmower.
2. Disconnect the spark plug.
3. Remove the cap from the charging point at the bottom of the wiring loom.
Y1 - Cap, Y2 - Charging Point, Y3 - Wiring Loom.
4. Plug charger lead into connection on battery loom
5. Plug the battery charger into a domestic electric socket.
6. Charging will then commence.
7. Charge for 24 hours.

8. After charging, disconnect the charger from the socket and charging point.
9. Replace the cap on the charging point.
10. The unit is now ready for use.

Battery Replacement

1. The battery is located underneath a cover behind the engine **(Z1)**.
2. Stop the lawnmower and disconnect the spark plug.
3. Remove the screws from the cover **(Z2)**.
4. Remove cover **(Z3)** to gain access to the battery.

CARING

At the End of the Mowing Season

1. Replace blade, bolts, nuts or screws, if necessary.
2. Clean your lawnmower thoroughly. Do not clean with chemicals, including petrol or solvents - some can destroy critical plastic parts.
3. Ask your local Service Centre to clean the air filter thoroughly and carry out any service or repairs required.
4. Drain engine of oil and petrol.

Storing your Lawnmower

1. Do not store your lawnmower immediately after use.
2. Wait until the engine has cooled to avoid a potential fire hazard.
3. Clean your lawnmower
4. Store in a cool, dry place where your lawnmower is protected from damage.

Engine Maintenance Schedule

Follow the hourly or calendar intervals, whichever occur first. More frequent service is required when operating in adverse conditions

First 5 hours - Change oil.

Every 5 hours or daily - Check oil level. Clean finger guard. Clean around silencer.

Every 25 hours or every season - Change oil if operating under heavy load or high ambient temperature. Service air cleaner.

Every 50 hours or every season - Change oil. Inspect spark arrester, if equipped.

Every 100 hours or every season - Clean cooling system*. Replace spark plug.

* Clean more often under dusty conditions, or when airborne debris is present or after prolonged operation cutting tall, dry grass.

FAULT FINDING

Engine Will Not Start

1. **Ensure OPC Lever is in the start position.**
2. Check that the control lever is in the Fast (run) position
3. Check that there is sufficient fuel in the tank and the cap air vent is clear.
4. Remove and dry the spark plug.
5. Petrol may be stale, replace. Once petrol has been replaced it may take a little time for fresh petrol to filter through.
6. Check that the blade bolt is tight. A loose bolt could cause difficult starting.
7. **If the engine will still not start, immediately disconnect the spark plug lead.**
CONSULT YOUR LOCAL APPROVED SERVICE CENTRE.

Engine Will Not Turn Over (Electrostart only)

1. **Ensure OPC Lever is in the start position.**
2. Battery flat - start your lawnmower manually.
3. **If the engine will still not turn over, immediately disconnect the spark plug lead.**
CONSULT YOUR LOCAL APPROVED SERVICE CENTRE.

Lack of Engine Power and/or Overheating

1. Check that the control lever is in the Fast (run) position.

2. Disconnect the spark plug lead and allow the engine to cool down.
3. Clean grass clippings and debris from around the engine and air inlets and the underside of the deck including the chute and the fan.
4. Clean the engine air filter (Ask your local Approved Service Centre to clean the engine air filter thoroughly).
5. Petrol may be stale, replace. Once petrol has been replaced it may take a little time for fresh petrol to filter through.
6. **If the engine still lacks power and/or is overheating, immediately disconnect the spark plug lead.**
CONSULT YOUR LOCAL APPROVED SERVICE CENTRE.

Excessive Vibration

1. Disconnect the spark plug lead.
2. Check that the blade is correctly fitted see page 6.
3. If the blade is damaged or worn replace it with a new one.
4. **If vibration persists, immediately disconnect the spark plug lead.**
CONSULT YOUR LOCAL APPROVED SERVICE CENTRE.

MAINTENANCE

ENGINE SERVICING & GUARANTEE

The engine fitted to your lawnmower is guaranteed by the Engine Manufacturer. To obtain further information contact your dealer as detailed below Briggs and Stratton

A list of authorised Briggs and Stratton Service Dealers is given on the back of this book.

SERVICE RECOMMENDATIONS

1. We strongly recommend that your product is serviced at least every twelve months, more often in a professional application.
2. Always use genuine Spare Parts.
3. Prepacked spares are available from most authorised stockists.
4. Your product is identified by a silver and black product rating label
5. If you have a problem with your machine contact your local Approved Service Centre ensuring you have full details of your product as described on the product rating label.

GUARANTEE AND GUARANTEE POLICY

If any part is found to be defective due to faulty manufacture within two years of original purchase, Electrolux Outdoor Products, through its Authorised Service Repairers will effect the repair or replacement to the customer free of charge providing:

- (a) The fault is reported directly to the Authorised Repairer.
 - (b) Proof of purchase is provided.
 - (c) The fault is not caused by misuse, neglect or faulty adjustment by the user.
 - (d) The failure has not occurred through fair wear and tear.
 - (e) The machine has not been serviced or repaired, taken apart or tampered with by any person not authorised by Electrolux Outdoor Products.
 - (f) The machine has not been used for hire.
 - (g) The machine is owned by the original purchaser.
 - (h) The machine has not been used outside of the country for which it was specified.
 - (i) The machine has not been used commercially.
- * This guarantee is additional to, and in no way diminishes the customers statutory rights.

Failures due to the following are not covered, therefore it is important that you read the instructions contained in

ENVIRONMENTAL INFORMATION

Electrolux Outdoor Products are manufactured under an Environmental Management System (ISO 14001) using, where practical, components manufactured in the most environmentally responsible manner, according to company procedures, and with the potential for recycling at the end of the products' life.

- Packaging is recyclable and plastic components have been labelled (where practical) for categorised recycling.
- Awareness of the environment must be considered when disposing of 'end-of-life' product.
- If necessary, contact your local authority for disposal information.

BATTERY DISPOSAL

- The battery should be taken to an Approved Service Centre or your local Recycling Station.
- **Do NOT dispose of used battery with household waste**
- **Lead/Acid batteries can be harmful and should be disposed of through the recognised recycling facility in accordance with European Regulation**

Tecumseh

A list of authorised Tecumseh Service Dealers is given on the back of this book.

6. Should it be necessary for work to be carried out by your Service Centre, it is important to take your complete petrol wheeled rotary lawnmower.

To obtain service on your product simply telephone or visit your local Service Centre. Should you require service under the terms of our guarantee the Service Centre will require proof of purchase.

All of the centres stock genuine Spare Parts.

NOTE: Our Service Repairers act on their own behalf and are not empowered to commit or legally bind Electrolux Outdoor Products in any manner whatsoever.

this Operator's Manual and understand how to operate and maintain your machine:

Failures not covered by guarantee

- * Replacing worn or damaged blades
 - * Failures as a result of not reporting an initial fault.
 - * Failures as a result of sudden impact.
 - * Failures as a result of not using the product in accordance with the instructions and recommendations contained in this Operator's Manual.
 - * Machines used for hire are not covered by this guarantee.
 - * The following items listed are considered as wearing parts and their life is dependent on regular maintenance and are, therefore not normally subject to a valid warranty claim: Blades, drive belts.
- * **Caution!**

Electrolux Outdoor Products does not accept liability under the warranty for defects caused in whole or part, directly or indirectly by the fitting of replacement parts or additional parts that are not either manufactured or approved by Electrolux Outdoor Products, or by the machine having been modified in any way.

- **Do NOT dispose of battery to water.**
- **Do NOT incinerate**

DISPOSAL OF FUELS AND LUBRICATING OILS

- Wear protective clothing when handling any fuels and lubricants.
- Avoid contact with skin.
- Remove petrol and engine oil before transporting the product.
- Contact your local authority for information of your nearest Recycling/Disposal Station.
- **Do NOT dispose of used fuels/oils with household waste**
- **Waste fuels/oils are harmful, but can be recycled and should be disposed of through the recognised facilities.**
- **Do NOT dispose of used fuels/oils to water.**
- **Do NOT incinerate**

BELGIQUE/BELGIË	Flymo Belgique/België Tel: 02 363 0311, Fax: 02 363 0391
ČESKÁ REPUBLIKA	Electrolux, spol. s.r.o., oz Electrolux Outdoor Products, Dobronická 635, 148 25 Praha 4 Tel: 02/6111 2408-9, Info-linka: 0800/110 220 Internet: www.partner-flymo.cz E-mail: info@husqvarna.cz
DANMARK	Electrolux Outdoor Products, Flymo/Partner A/S, Lundtoftegårdsvej 93A, DK 2800 Kgs.Lyngby Tel: 45 877577, www.flymo-partner.dk
DEUTSCHLAND	Flymo Deutschland Tel: 097 21 7640, Fax:097 21 764202
ESTONIA	Electrolux Estonia Ltd (Electrolux Eesti AS) Tel: (372) 6650010
FRANCE	Flymo France SNC Tel 01 46 67 8141, Fax 01 43 34 2491
FINLAND SUOMI	Flymo Finland Suomi Tel: 00 39611, Fax: 00 39 612632
ITALIA	McCulloch Italiana s.r.l. - Via Como 72, 23868 Valmadrera (LECCO) - ITALIA Tel: 800 017829, Fax: 0341 581671
IRELAND	Flymo Ireland Tel: 01 4565222, Fax: 01 4568551
MAGYARORSZÁG	Electrolux Lehel Kft Tel: 00 36 1 251 41 47
NORGE	Flymo/Partner, div. av Electrolux Motor a.s. Tel: 69 10 47 90
NEDERLAND	Flymo Nederland Tel: 0172-468322, Fax: 0172-468219
ÖSTERREICH	HUSQVARNA Zentralwerkstätte, Industriezeile 36, 4020 LINZ, Tel: 0732 770101-60, Fax: 0732 795922
POLSKA	Electrolux Poland Sp. z.o.o. Husqvarna, 01-612 Warszawa Myslowicka 10/2 Tel:- (22) 8332949
SLOVENIJA	SKANTEH d.o.o. Tel:- (061) 133 70 68, Fax:-(061) 133 70 68
SLOVENSKA	Electrolux Slovakia s.r.o., Borova Sihat 211, 033 01 Lipt. Hradok Tel: 044 522 14 19, Fax: 044 522 14 18, www.flymo-partner.sk
SCHWEIZ/SUISSE/SUIZZERA	Flymo Schweiz/Suisse/Suizzera Tel 062 889 93 50 / 889 94 25, Fax 062 889 93 60 / 889 94 35
SVERIGE	Electrolux Outdoor Products, Sverige Tel: 036 – 14 67 00, Fax: 036 – 14 60 70
UNITED KINGDOM	Electrolux Outdoor Products United Kingdom Tel: 01325 300303, Fax: 01325 310339

Tecumseh**Briggs & Stratton**

UK - United Kingdom
 Tecumseh UK Ltd
 152 Commercial Road
 Staines
 Middlesex
 TX18 2QP
 England
 Tel: (44) 1784 460684
 Fax: (44) 1784 453563

D - Germany
 Tecumseh Deutschland GmbH
 Virmondstr. 137
 47887 Willich-Neersen
 Germany
 Tel: (49) 21 56 9588 0
 Fax: (49) 21 56 9588 18

F - France
 Tecumseh Service France
 Parc des Bellevues,
 Immeuble "Le Minnesota"
 Allée Rosa Luxembourg
 B.P. 242 - ERAGNY SUR OISE
 95615 CERGY-POTHOISE CEDEX
 France
 Tel: (33) 1 343 04484
 Fax: (33) 1 346 44415

E - Spain
 Tecna S.A. de Motores y Repuestos
 C/Ciclón, 20
 P. Ind. San Jose de Valderas II
 28918 Leganés (Madrid)
 Tel: (34) 91 611 0461
 Fax: (34) 91 611 2953

I - Italy
 Tecumseh Europa S.p.A.
 Via Delle Cacce 99
 10135 Torino
 Italy
 Tel: (39) 011 391 8411
 Fax: (39) 011 391 0031

NL - Netherlands
 OSMA
 Utrechtseweg 117
 6871 DR Renkum
 Netherlands
 Tel: (31) 31 731 9008
 Fax: (31) 31 731 8762

N - Norway
 Bergsto Motor A/S
 Kongsgård
 4602 Kristiansand S
 Norway
 Tel: (47) 380 96028
 Fax: (47) 380 95031

SF - Finland
 Oy Inter-Motor Ab
 Laivanrakentajantie 2
 00981 Helsinki
 Finland
 Tel: (358) 9 341 2570
 Fax: (358) 9 341 2580

S - Sweden
 Swed Motor AB
 Rårvägen 6
 137-21 Västerhaninge
 Sweden
 Tel: (46) 8 500 12140
 Fax: (46) 8 500 26800

DK - Denmark
 Elano-Odense A/S
 Holkebjergvej 67
 DK-5250 Odense SV
 Denmark
 Tel: (45) 66 175253
 Fax: (45) 66 170153

UK - United Kingdom
 Briggs & Stratton U.K. Limited
 Unit 10 Ashton Gate
 Ashton Road, Harrold Hill
 Romford, Essex, RM3 8UF
 England
 Tel: (44) 1708 335640, 335620,
 335600
 Fax: (44) 1708 335641, 335621,
 335601

D - Germany
 Briggs & Stratton Germany GmbH
 Schwetznier Str. 19
 D-68519 Viernheim
 Tel: (49) 6204 60010
 Fax: (49) 6204 600180/600181

F - France
 Briggs & Stratton France, S.A.R.L.
 B.P. 8
 78184 St. Quentin en Yvelines Cedex
 43, avenue des trois Peuples
 78180 Montigny-le-Bretonneux
 Tel: (33) 1 3012 5700
 Fax: (33) 1 3012 5729

E - Spain
 Industrias Fita, S.A.
 Apartado 177
 Passeje del Cementiri s/n
 E-17600 Figueras
 Tel: (34) 972 500504
 Fax: (34) 972 509372

I - Italy
 RAMA MOTORI S.p.A.
 Via Agnoletti (Zona Annonaria), 8
 I-42100 Reggio Emilia
 Tel: (39) 522 930 711
 Fax: (39) 522 930 730

NL - Netherlands
 Motor Snelco, B.V.
 Bedrijfsweg 130
 NL-8304 AA Emmeloord
 Tel: (31) 527 615151
 Fax: (31) 527 699121

N - Norway
 Safe Motor A/S
 Olaf Schous Vei 6
 P.O. Box 6569 Rodelokka
 N-0501, Oslo
 Tel: (47) 23 23 48 20
 Fax: (47) 22 385832

SF - Finland
 Oy. Promotor AB
 Sahaajankatu 41
 SF-00880 Helsinki
 P.O. Box 32
 SF 00880 Helsinki
 Tel: (358) 9 755 4633
 Fax: (358) 9 755 4025

S - Sweden
 Briggs & Stratton Sweden AB
 Ellipsvägen 11-13
 S-141 70 Huddinge
 P.O. Box 151
 S-127 23 Skaerholmen
 Tel: (46) 8 449 5630
 Fax: (46) 8 449 5631

DK - Denmark
 Ketner Teknik/Axel Ketner
 Broddy A/S
 Vibeholms Allé 15
 Postbox 43
 Broddy
 Tel: (45) 43 27 11 66
 Fax: (45) 43 96 10 14

Electrolux Outdoor Products
 Aycliffe Industrial Park
 NEWTON AYCLIFFE
 Co.Durham DL5 6UP
 ENGLAND

Telephone - (00) 44 1325 300303 Fax - (00) 44 1325 310339

UK Telephone - 01325 300303 Fax - 01325 310339

Our policy of continuous improvement means that the specification of products may be altered from time to time without prior notice. Electrolux Outdoor Products manufactures products for a number of well known brands under various registered patents, designs and trademarks in several countries.

© Electrolux Outdoor Products Ltd. Registered Office, Electrolux Works, Oakley Road, Luton LU4 9QQ
 Registered number 974979 England



The Electrolux Group. The world's No. 1 choice.

The Electrolux Group is the world's largest producer of powered appliances for kitchen, cleaning and outdoor use. More than 55 million Electrolux Group products (such as refrigerators, cookers, washing machines, vacuum cleaners, chain saws and lawn mowers) are sold each year to a value of approx. USD 14 billion in more than 150 countries around the world.



5119285-02(02/02)