

Cub Cadet[®]

OPERATOR'S MANUAL

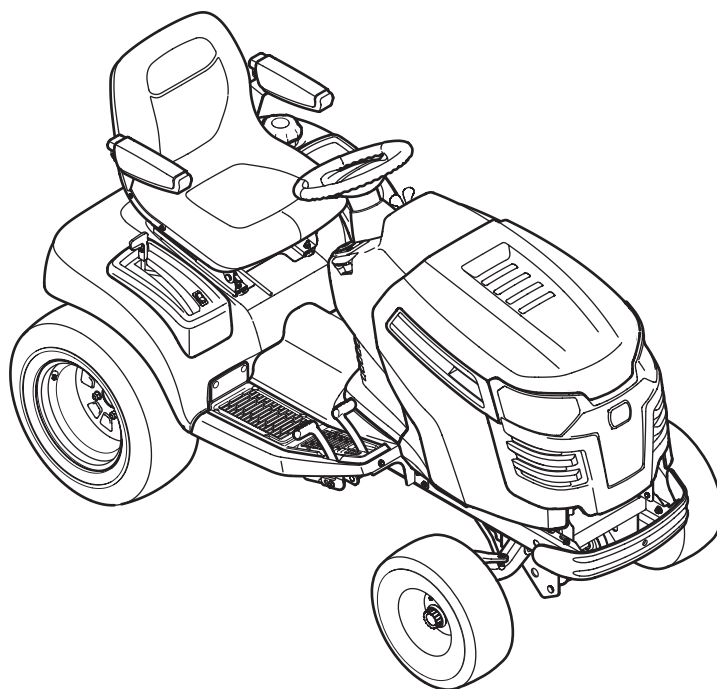

GT 2000, GTX 2000 & GTX 2100

⚠ WARNING

**READ AND FOLLOW ALL SAFETY RULES AND INSTRUCTIONS IN THIS MANUAL
BEFORE ATTEMPTING TO OPERATE THIS MACHINE.
FAILURE TO COMPLY WITH THESE INSTRUCTIONS MAY RESULT IN PERSONAL INJURY.**

CUB CADET LLC, P.O. BOX 361131 CLEVELAND, OHIO 44136-0019

Thank You

Thank you for purchasing a Cub Cadet Garden Tractor. It was carefully engineered to provide excellent performance when properly operated and maintained.

Please read this entire manual prior to operating the equipment. It instructs you how to safely and easily set up, operate and maintain your machine. Please be sure that you, and any other persons who will operate the machine, carefully follow the recommended safety practices at all times. Failure to do so could result in personal injury or property damage.

All information in this manual is relative to the most recent product information available at the time of printing. Review this manual frequently to familiarize yourself with the machine, its features and operation. Please be aware that this Operator's Manual may cover a range of product specifications for various models. Characteristics and features discussed and/or illustrated in this manual may not be applicable to all models. We reserve the right to change product specifications, designs and equipment without notice and without incurring obligation.

If applicable, the power testing information used to establish the power rating of the engine equipped on this machine can be found at www.opei.org or the engine manufacturer's web site.

If you have any problems or questions concerning the machine, phone your local authorized MTD service dealer or contact us directly. MTD's Customer Support telephone numbers, website address and mailing address can be found on this page. We want to ensure your complete satisfaction at all times.

Throughout this manual, all references to *right* and *left* side of the machine are observed from the operating position

The engine manufacturer is responsible for all engine-related issues with regards to performance, power-rating, specifications, warranty and service. Please refer to the engine manufacturer's Owner's/Operator's Manual, packed separately with your machine, for more information.

Table of Contents

| | | | |
|---|-----------|--|-----------|
| Safe Operation Practices | 3 | Service | 24 |
| Assembly & Set-Up | 9 | Troubleshooting | 26 |
| Controls & Features..... | 11 | Replacement Parts | 27 |
| Operation..... | 14 | Attachments & Accessories | 28 |
| Maintenance & Adjustment | 18 | Warranties | 30 |

Record Product Information

Before setting up and operating your new equipment, please locate the model plate on the equipment and record the information in the provided area to the right. You can locate the model plate by looking beneath the seat. This information will be necessary, should you seek technical support via our web site, Customer Support Department, or with a local authorized service dealer.

MODEL NUMBER

| | | | | | | | | | | |
|--|--|--|--|--|--|--|--|--|--|--|
| | | | | | | | | | | |
|--|--|--|--|--|--|--|--|--|--|--|

SERIAL NUMBER

| | | | | | | | | | | |
|--|--|--|--|--|--|--|--|--|--|--|
| | | | | | | | | | | |
|--|--|--|--|--|--|--|--|--|--|--|

Product Registration and Customer Support

Please register your product on our website, www.cubcadet.com.

If you have difficulty assembling this product or have any questions regarding the controls, operation, or maintenance of this machine, you can seek help from the experts. Choose from the options below:

- ◇ Visit us on the web at www.cubcadet.com



See How-to Maintenance and Parts Installation Videos at www.cubcadet.com/tutorials

- ◇ Call a Customer Support Representative at (800) 965-4CUB
- ◇ Locate your nearest Cub Cadet Dealer at (877) 282-8684
- ◇ Write to Cub Cadet LLC • P.O. Box 361131 • Cleveland, OH • 44136-0019



WARNING! This symbol points out important safety instructions which, if not followed, could endanger the personal safety and/or property of yourself and others. Read and follow all instructions in this manual before attempting to operate this machine. Failure to comply with these instructions may result in personal injury.

When you see this symbol. **HEED ITS WARNING!**

CALIFORNIA PROPOSITION 65



WARNING! Engine Exhaust, some of its constituents, and certain vehicle components contain or emit chemicals known to State of California to cause cancer and birth defects or other reproductive harm.



WARNING! Battery posts, terminals, and related accessories contain lead and lead compounds, chemicals known to the State of California to cause cancer and reproductive harm. *Wash hands after handling*



DANGER! This machine was built to be operated according to the safe operation practices in this manual. As with any type of power equipment, carelessness or error on the part of the operator can result in serious injury. This machine is capable of amputating hands and feet and throwing objects. Failure to observe the following safety instructions could result in serious injury or death.

General Operation

1. Read, understand, and follow all instructions on the machine and in the manual(s) before attempting to assemble and operate. Keep this manual in a safe place for future and regular reference and for ordering replacement parts.
2. Be familiar with all controls and their proper operation. Know how to stop the machine and disengage them quickly.
3. Never allow children under 14 years of age to operate this machine. Children 14 and over should read and understand the instructions and safe operation practices in this manual and on the machine and should be trained and supervised by an adult.
4. Never allow adults to operate this machine without proper instruction.
5. To help avoid blade contact or a thrown object injury, keep bystanders, helpers, children and pets at least 75 feet from the machine while it is in operation. Stop machine if anyone enters the area.
6. Thoroughly inspect the area where the equipment is to be used. Remove all stones, sticks, wire, bones, toys, and other foreign objects which could be picked up and thrown by the blade(s). Thrown objects can cause serious personal injury.
7. Plan your mowing pattern to avoid discharge of material toward roads, sidewalks, bystanders and the like. Also, avoid discharging material against a wall or obstruction which may cause discharged material to ricochet back toward the operator.
8. Always wear safety glasses or safety goggles during operation and while performing an adjustment or repair to protect your eyes. Thrown objects which ricochet can cause serious injury to the eyes.
9. Wear sturdy, rough-soled work shoes and close-fitting slacks and shirts. Loose fitting clothes and jewelry can be caught in movable parts. Never operate this machine in bare feet or sandals.
10. Be aware of the mower and attachment discharge direction and do not point it at anyone. Do not operate the mower without the discharge cover or entire grass catcher in its proper place.
11. Do not put hands or feet near rotating parts or under the cutting deck. Contact with the blade(s) can amputate hands and feet.

12. A missing or damaged discharge cover can cause blade contact or thrown object injuries.
13. Stop the blade(s) when crossing gravel drives, walks, or roads and while not cutting grass.
14. Watch for traffic when operating near or crossing roadways. This machine is not intended for use on any public roadway.
15. Do not operate the machine while under the influence of alcohol or drugs.
16. Mow only in daylight or good artificial light.
17. Never carry passengers.
18. Disengage blade(s) before shifting into reverse. Back up slowly. Always look down and behind before and while backing to avoid a back-over accident.
19. Slow down before turning. Operate the machine smoothly. Avoid erratic operation and excessive speed.
20. Disengage blade(s), set parking brake, stop engine and wait until the blade(s) come to a complete stop before removing grass catcher, emptying grass, unclogging chute, removing any grass or debris, or making any adjustments.
21. Never leave a running machine unattended. Always turn off blade(s), place transmission in neutral, set parking brake, stop engine and remove key before dismounting.
22. Use extra care when loading or unloading the machine into a trailer or truck. This machine should not be driven up or down ramp(s), because the machine could tip over, causing serious personal injury. The machine must be pushed manually on ramp(s) to load or unload properly.
23. Muffler and engine become hot and can cause a burn. Do not touch.
24. Check overhead clearances carefully before driving under low hanging tree branches, wires, door openings etc., where the operator may be struck or pulled from the machine, which could result in serious injury.
25. Disengage all attachment clutches, depress the brake pedal completely and shift into neutral before attempting to start engine.
26. Your machine is designed to cut normal residential grass of a height no more than 10". Do not attempt to mow through unusually tall, dry grass (e.g., pasture) or piles of dry leaves. Dry grass or leaves may contact the engine exhaust and/or build up on the mower deck presenting a potential fire hazard.
27. Use only accessories and attachments approved for this machine by the machine manufacturer. Read, understand and follow all instructions provided with the approved accessory or attachment.
28. Data indicates that operators, age 60 years and above, are involved in a large percentage of riding mower-related injuries. These operators should evaluate their ability to operate the riding mower safely enough to protect themselves and others from serious injury.
29. If situations occur which are not covered in this manual, use care and good judgment. Contact your customer service representative for assistance.

Slope Operation

Slopes are a major factor related to loss of control and tip-over accidents which can result in severe injury or death. All slopes require extra caution. If you cannot back up the slope or if you feel uneasy on it, do not mow it.

For your safety, use the slope gauge included as part of this manual to measure slopes before operating this machine on a sloped or hilly area. If the slope is greater than 15 degrees as shown on the slope gauge, do not operate this machine on that area or serious injury could result.

Do:

1. Mow up and down slopes, not across. Exercise extreme caution when changing direction on slopes.
2. Watch for holes, ruts, bumps, rocks, or other hidden objects. Uneven terrain could overturn the machine. Tall grass can hide obstacles.
3. Use slow speed. Choose a low enough speed setting so that you will not have to stop or shift while on the slope. Tires may lose traction on slopes even though the brakes are functioning properly. Always keep machine in gear when going down slopes to take advantage of engine braking action.
4. Follow the manufacturer's recommendations for wheel weights or counterweights to improve stability.
5. Use extra care with grass catchers or other attachments. These can change the stability of the machine.
6. Keep all movement on the slopes slow and gradual. Do not make sudden changes in speed or direction. Rapid engagement or braking could cause the front of the machine to lift and rapidly flip over backwards which could cause serious injury.
7. Avoid starting or stopping on a slope. If tires lose traction, disengage the blade(s) and proceed slowly straight down the slope.

Do Not:

1. Do not turn on slopes unless necessary; then, turn slowly and gradually downhill, if possible.
2. Do not mow near drop-offs, ditches or embankments. The mower could suddenly turn over if a wheel is over the edge of a cliff, ditch, or if an edge caves in.
3. Do not try to stabilize the machine by putting your foot on the ground.
4. Do not use a grass catcher on steep slopes.
5. Do not mow on wet grass. Reduced traction could cause sliding.
6. Do not shift to neutral and coast downhill. Over-speeding may cause the operator to lose control of the machine resulting in serious injury or death.
7. Do not tow heavy pull behind attachments (e.g. loaded dump cart, lawn roller, etc.) on slopes greater than 5 degrees. When going down hill, the extra weight tends to push the tractor and may cause you to lose control (e.g. tractor may speed up, braking and steering ability are reduced, attachment may jack-knife and cause tractor to overturn).

Children

1. Tragic accidents can occur if the operator is not alert to the presence of children. Children are often attracted to the machine and the mowing activity. They do not understand the dangers. Never assume that children will remain where you last saw them.
 - a. Keep children out of the mowing area and in watchful care of a responsible adult other than the operator.
 - b. Be alert and turn machine off if a child enters the area.
 - c. Before and while backing, look behind and down for small children.
 - d. Never carry children, even with the blade(s) shut off. They may fall off and be seriously injured or interfere with safe machine operation.
 - e. Use extreme care when approaching blind corners, doorways, shrubs, trees or other objects that may block your vision of a child who may run into the path of the machine.
 - f. To avoid back-over accidents, always disengage the cutting blade(s) before shifting into Reverse. If equipped, the "Reverse Caution Mode" should not be used when children or others are around.
 - g. Keep children away from hot or running engines. They can suffer burns from a hot muffler.
 - h. Remove key when machine is unattended to prevent unauthorized operation.
2. Never allow children under 14 years of age to operate this machine. Children 14 and over should read and understand the instructions and safe operation practices in this manual and on the machine and should be trained and supervised by an adult.

Towing

1. Tow only with a machine that has a hitch designed for towing. Do not attach towed equipment except at the hitch point.
2. Follow the manufacturer's recommendation for weight limits for towed equipment and towing on slopes.
3. Never allow children or others in or on towed equipment.
4. On slopes, the weight of the towed equipment may cause loss of traction and loss of control.
5. Always use extra caution when towing with a machine capable of making tight turns (e.g. "zero-turn" ride-on mower). Make wide turns to avoid jack-knifing.
6. Travel slowly and allow extra distance to stop.
7. Do not shift to neutral and coast downhill.

Service

Safe Handling of Gasoline:

1. To avoid personal injury or property damage use extreme care in handling gasoline. **Gasoline is extremely flammable and the vapors are explosive.** Serious personal injury can occur when gasoline is spilled on yourself or your clothes which can ignite. Wash your skin and change clothes immediately.
 - a. Use only an approved gasoline container.
 - b. Never fill containers inside a vehicle or on a truck or trailer bed with a plastic liner. Always place containers on the ground away from your vehicle before filling.
 - c. When practical, remove gas-powered equipment from the truck or trailer and refuel it on the ground. If this is not possible, then refuel such equipment on a trailer with a portable container, rather than from a gasoline dispenser nozzle.
 - d. Keep the nozzle in contact with the rim of the fuel tank or container opening at all times until fueling is complete. Do not use a nozzle lock-open device.
 - e. Extinguish all cigarettes, cigars, pipes and other sources of ignition.
 - f. Never fuel machine indoors.
 - g. Never remove gas cap or add fuel while the engine is hot or running. Allow engine to cool at least two minutes before refueling.
 - h. Never over fill fuel tank. Fill tank to no more than the bottom of filler neck to allow space for fuel expansion.
 - i. Replace gasoline cap and tighten securely.
 - j. If gasoline is spilled, wipe it off the engine and equipment. Move machine to another area. Wait 5 minutes before starting the engine.
 - k. To reduce fire hazards, keep machine free of grass, leaves, or other debris build-up. Clean up oil or fuel spillage and remove any fuel soaked debris.
 - l. Never store the machine or fuel container inside where there is an open flame, spark or pilot light as on a water heater, space heater, furnace, clothes dryer or other gas appliances.
 - m. Allow a machine to cool at least five minutes before storing.

General Service

1. Never run an engine indoors or in a poorly ventilated area. Engine exhaust contains carbon monoxide, an odorless, and deadly gas.
2. Before cleaning, repairing, or inspecting, make certain the blade(s) and all moving parts have stopped. Disconnect the spark plug wire and ground against the engine to prevent unintended starting.

3. Periodically check to make sure the blades come to complete stop within approximately (5) five seconds after operating the blade disengagement control. If the blades do not stop within the this time frame, your machine should be serviced professionally by an authorized Cub Cadet Service Dealer.
4. Check brake operation frequently as it is subjected to wear during normal operation. Adjust and service as required.
5. Check the blade(s) and engine mounting bolts at frequent intervals for proper tightness. Also, visually inspect blade(s) for damage (e.g., excessive wear, bent, cracked). Replace the blade(s) with the original equipment manufacturer's (O.E.M.) blade(s) only, listed in this manual. "Use of parts which do not meet the original equipment specifications may lead to improper performance and compromise safety!"
6. Mower blades are sharp. Wrap the blade or wear gloves, and use extra caution when servicing them.
7. Keep all nuts, bolts, and screws tight to be sure the equipment is in safe working condition.
8. Never tamper with the safety interlock system or other safety devices. Check their proper operation regularly.
9. After striking a foreign object, stop the engine, disconnect the spark plug wire(s) and ground against the engine. Thoroughly inspect the machine for any damage. Repair the damage before starting and operating.
10. Never attempt to make adjustments or repairs to the machine while the engine is running.
11. Grass catcher components and the discharge cover are subject to wear and damage which could expose moving parts or allow objects to be thrown. For safety protection, frequently check components and replace immediately with original equipment manufacturer's (O.E.M.) parts only, listed in this manual. "Use of parts which do not meet the original equipment specifications may lead to improper performance and compromise safety!"
12. Do not change the engine governor settings or over-speed the engine. The governor controls the maximum safe operating speed of the engine.
13. Maintain or replace safety and instruction labels, as necessary.
14. Observe proper disposal laws and regulations for gas, oil, etc. to protect the environment.
15. According to the Consumer Products Safety Commission (CPSC) and the U.S. Environmental Protection Agency (EPA), this product has an *Average Useful Life* of seven (7) years, or 390 hours of operation. At the end of the *Average Useful Life* have the machine inspected annually by an authorized service dealer to ensure that all mechanical and safety systems are working properly and not worn excessively. Failure to do so can result in accidents, injuries or death.

Do not modify engine

To avoid serious injury or death, do not modify engine in any way. Tampering with the governor setting can lead to a runaway engine and cause it to operate at unsafe speeds. Never tamper with factory setting of engine governor.

Notice Regarding Emissions

Engines which are certified to comply with California and federal EPA emission regulations for SORE (Small Off Road Equipment) are certified to operate on regular unleaded gasoline, and may include the following emission control systems: Engine Modification (EM), Oxidizing Catalyst (OC), Secondary Air Injection (SAI) and Three Way Catalyst (TWC) if so equipped.

When required, models are equipped with low permeation fuel lines and fuel tanks for evaporative emission control. California models may also include a carbon canister. Please contact Customer Support for information regarding the evaporative emission control configuration for your model.

Spark Arrestor



WARNING! This machine is equipped with an internal combustion engine and should not be used on or near any unimproved forest-covered, brushcovered or grass-covered land unless the engine's exhaust system is equipped with a spark arrestor meeting applicable local or state laws (if any).

If a spark arrestor is used, it should be maintained in effective working order by the operator. In the State of California the above is required by law (Section 4442 of the California Public Resources Code). Other states may have similar laws. Federal laws apply on federal lands.

A spark arrestor for the muffler is available through your nearest engine authorized service dealer or contact the service department, P.O. Box 361131 Cleveland, Ohio 44136-0019.











WARNING! Your Responsibility—Restrict the use of this power machine to persons who read, understand and follow the warnings and instructions in this manual and on the machine.

SAVE THESE INSTRUCTIONS!

Safety Symbols

This page depicts and describes safety symbols that may appear on this product. Read, understand, and follow all instructions on the machine before attempting to assemble and operate.

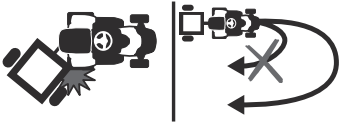
| Symbol | Description |
|---|--|
|  | READ THE OPERATOR'S MANUAL(S) Read, understand, and follow all instructions in the manual(s) before attempting to assemble and operate |
|  | DANGER— ROTATING BLADES Never carry passengers. Never carry children, even with the blades off. |
|  | DANGER— ROTATING BLADES Always look down and behind before and while backing to avoid a back-over accident. |
|  | WARNING— ROTATING BLADES Do not put hands or feet near rotating parts or under the cutting deck. Contact with the blade(s) can amputate hands and feet. |
|  | WARNING—THROWN OBJECTS This machine may pick up and throw and objects which can cause serious personal injury. |
|  | WARNING—THROWN OBJECTS This machine may pick up and throw and objects which can cause serious personal injury. |
|  | BYSTANDERS Keep bystanders, helpers, children and pets at least 75 feet from the machine while it is in operation. |
|  | WARNING— SLOPE OPERATION Do not operate this machine on a slope greater than 15 degrees. |
|  | WARNING— HOT SURFACE Engine parts, especially the muffler, become extremely hot during operation. Allow engine and muffler to cool before touching. |
|  | DANGER — ROTATING BLADES To reduce the risk of injury, keep hands and feet away. Do not operate unless discharge cover or grass catcher is in its proper place. If damaged, replace immediately. |
|  | WARNING— TOWING Avoid jack-knifing when towing, go slow and make wide turns. |

Slope Gauge

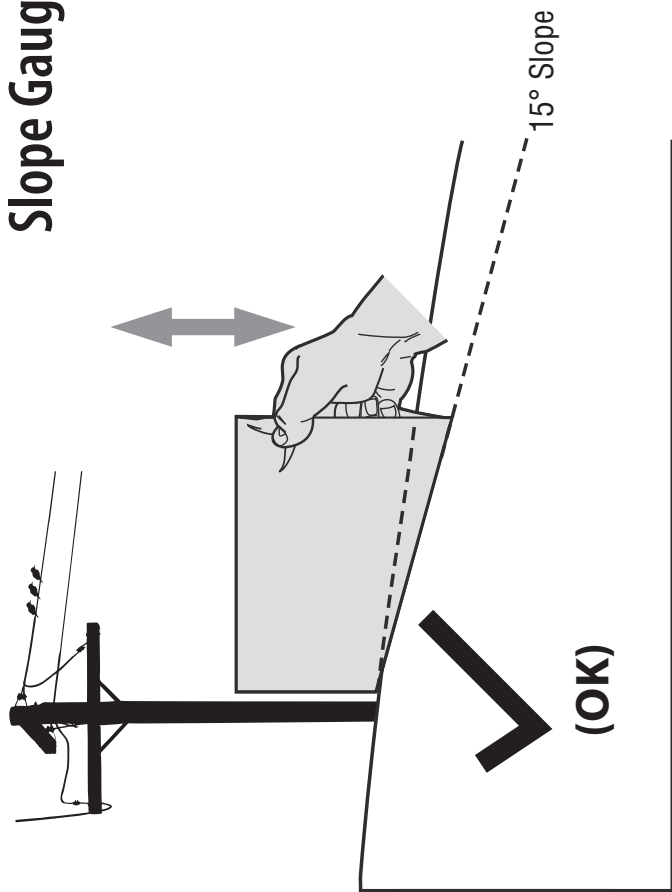

Figure 1

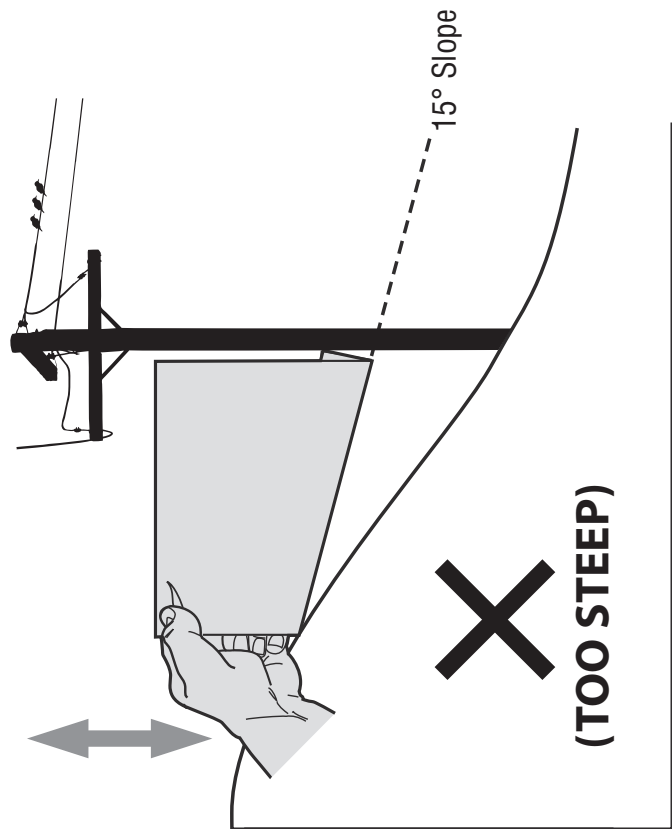

Figure 2

15° dashed line

USE THIS SLOPE GAUGE TO DETERMINE IF A SLOPE IS TOO STEEP FOR SAFE OPERATION!

To check the slope, proceed as follows:

1. Remove this page and fold along the dashed line.
2. Locate a vertical object on or behind the slope (e.g. a pole, building, fence, tree, etc.)
3. Align either side of the slope gauge with the object (See Figure 1 and Figure 2).
4. Adjust gauge up or down until the left corner touches the slope (See Figure 1 and Figure 2).
5. If there is a gap below the gauge, the slope is too steep for safe operation (See Figure 2 above).



WARNING! Slopes are a major factor related to tip-over and roll-over accidents which can result in severe injury or death. Do not operate machine on slopes in excess of 15 degrees. All slopes require extra caution. If you cannot back up the slope or if you feel uneasy on it, do not mow it. Always mow up and down slopes, never across the face of slopes.

Contents of Crate

- One Garden Tractor
- One Operator's Manual
- One Engine Operator's Manual

NOTE: This Operator's Manual covers several models. Tractor features may vary by model. Not all features in this manual are applicable to all tractor models and the tractor depicted may differ from yours.

Tractor Set-Up

Moving The Tractor Manually

Your tractor's transmission is equipped with a hydrostatic relief valve for occasions when it is necessary to move the tractor manually. Opening this valve permits the fluid in the transmission to bypass its normal route, allowing the rear tires to "freewheel." To open the hydrostatic relief valve, proceed as follows:

1. Locate the hydrostatic bypass rod in the rear of the tractor. See Figure 3-1.

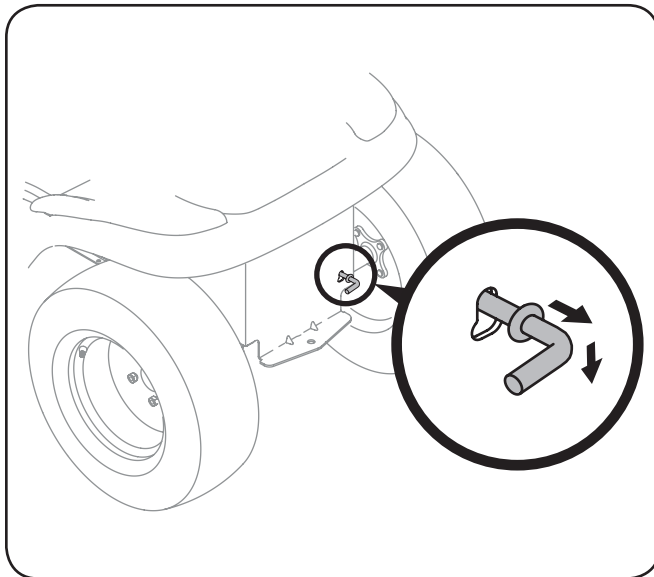

Figure 3-1

2. Pull the hydrostatic bypass rod down, outward and then up to lock it in place.

NOTE: If the tractor will not move or does not move freely when pushing check if the bypass lever is fully open.

NOTE: The transmission will NOT engage when the hydrostatic bypass rod is pulled out. Return the rod to its normal position prior to operating the tractor. If the tractor will not move when pushing on the forward/reverse pedals, or moves slowly, check to see if the bypass valve is on.



CAUTION: Never attempt to move the tractor manually without first opening the hydrostatic relief valve. Doing so will result in serious damage to the tractor's transmission.

Connecting the Battery Cables



CALIFORNIA PROPOSITION 65 WARNING!

Battery posts, terminals, and related accessories contain lead and lead compounds, chemicals known to the State of California to cause cancer and reproductive harm. Wash hands after handling.



CAUTION: When attaching battery cables, always connect the POSITIVE (red) wire to its terminal first, followed by the NEGATIVE (black) wire.

For shipping reasons, both battery cables on your equipment may have been left disconnected from the terminals at the factory. To connect the battery cables, proceed as follows:

NOTE: The positive battery terminal is marked Positive (+). The negative battery terminal is marked Negative (-).

1. Remove the plastic cover, if present, from the positive (+) battery terminal and attach the red cable to the positive (+) battery terminal with the bolt and hex nut. See Figure 3-2.

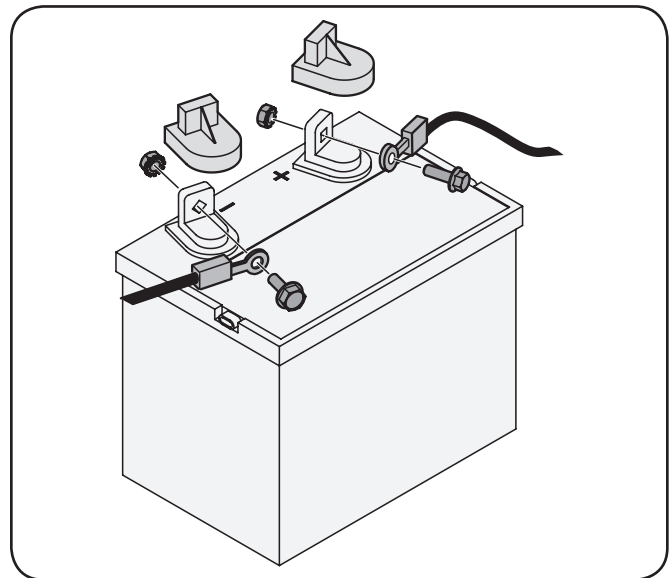

Figure 3-2

2. Remove the plastic cover, if present, from the negative (-) battery terminal and attach the black cable to the negative (-) battery terminal with the bolt and hex nut. See Figure 3-2.
3. Position the red rubber boot over the positive (+) battery terminal to help protect it from corrosion.

NOTE: If the battery is put into service after the date shown on top or side of battery, charge the battery as instructed in the Maintenance section your Operator's Manual prior to operating the tractor.

Checking Tire Pressure



WARNING! Maximum tire pressure under any circumstances is 10 psi on rear tires and 12 psi on front tires. Equal tire pressure should be maintained at all times.

The tires on your tractor may be over-inflated for shipping purposes. Reduce the tire pressure before operating the tractor. Recommended operating tire pressure is approximately 10 p.s.i. for the rear tires & 12 psi for the front tires. Check sidewall of tire for maximum psi.

Adjusting the Seat

To adjust the position of the seat, push the seat adjustment lever to the left. Slide the seat forward or rearward to the desired position; then release the adjustment lever. Make sure seat is locked into position before operating the tractor. See Figure 3-3.

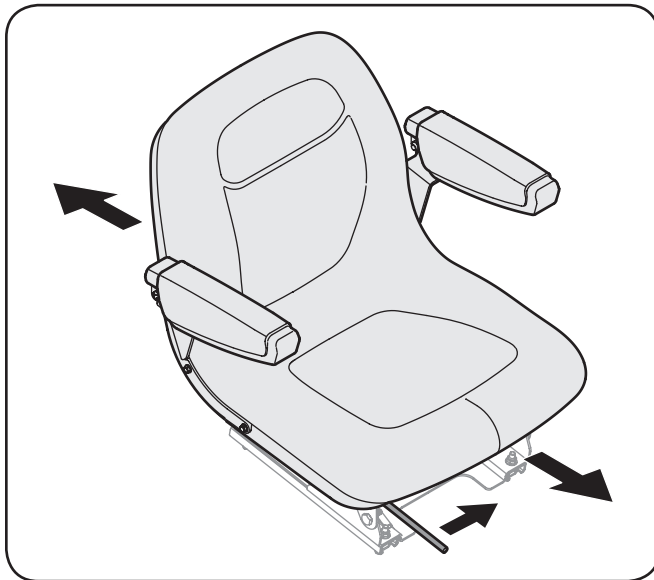

Figure 3-3

Gas and Oil

The fuel tank is located at the rear of the tractor and holds 4-½ gallons of gas. Remove the fuel cap by turning it counter-clockwise. Use only clean, fresh (no more than 30 days old), unleaded gasoline. Fill the tank no higher the bottom of the fill neck to allow space for fuel expansion.



WARNING! Use extreme care when handling gasoline. Gasoline is extremely flammable and the vapors are explosive. Never fuel the machine indoors or while the engine is hot or running. Extinguish cigarettes, cigars, pipes and other sources of ignition.

NOTE: Your tractor is shipped with oil in the engine. However, you **MUST** check the oil level before operating.



CAUTION: Always check the engine oil level before each use as instructed in the Kohler Owner's Manual. Add oil as necessary. Failure to do so may result in serious damage to your engine

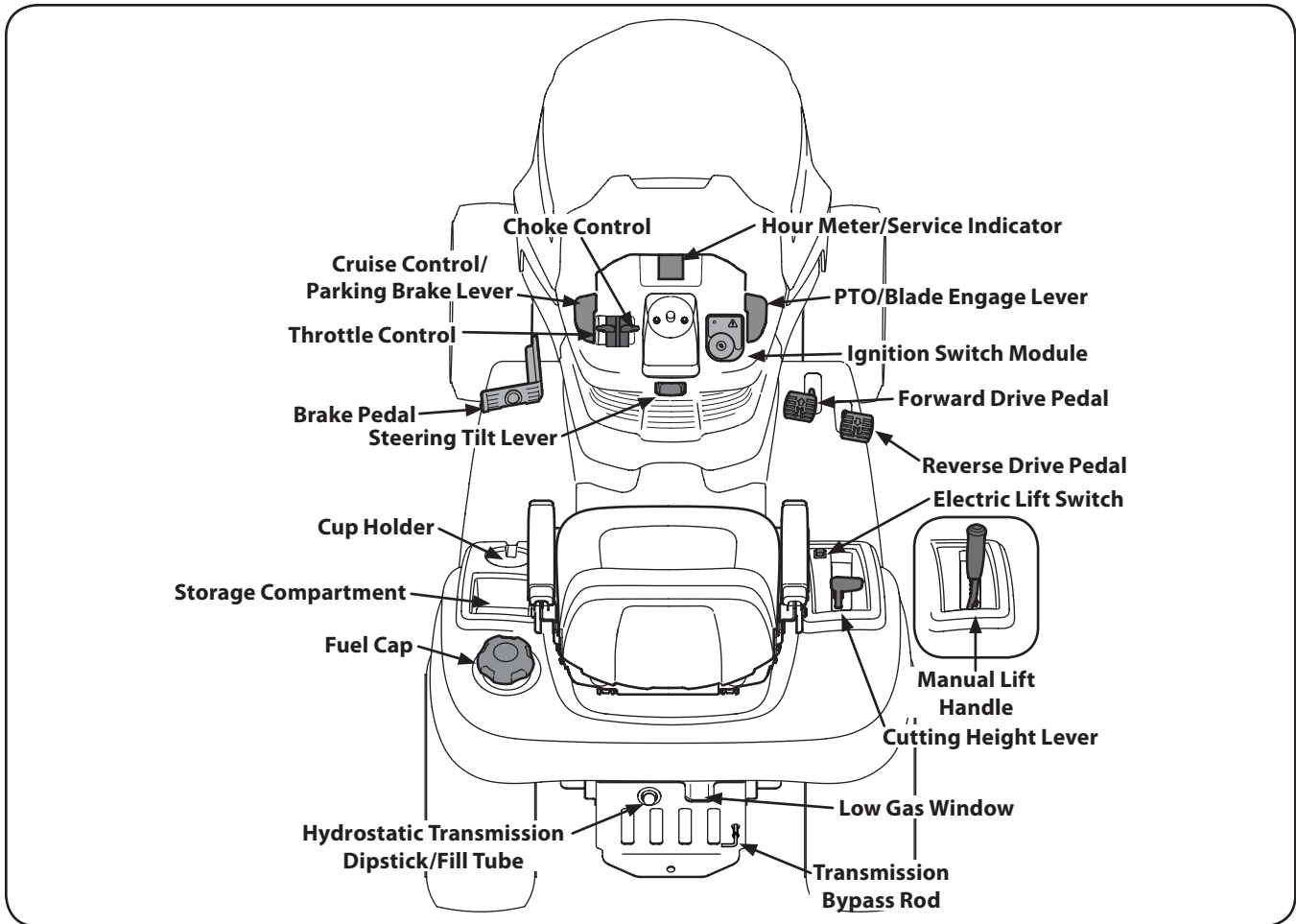

Garden Tractor controls and features are illustrated in Fig 4-1 and described on the following pages.

NOTE: This Operator's Manual covers several models. Tractor features may vary by model. Not all features in this manual are applicable to all tractor models and the tractor depicted may differ from yours.





WARNING! Read and follow all safety rules and instructions in this manual, including the entire Operation section, before attempting to operate this machine. Failure to comply with all safety rules and instructions may result in personal injury.

Choke Control

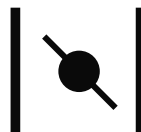
The choke control can be found on the left side of the dash panel and is activated by sliding the lever forward. Activating the choke control closes the choke plate on the carburetor and aids in starting the engine. Refer to Starting The Engine in the Operation section of this manual for detailed starting instructions.



Throttle Control Lever

The throttle control lever is located on the left side of the tractor's dash panel and slides between the FAST  and SLOW  positions. This lever controls the speed of the engine. When set in a given position, the throttle will maintain a uniform engine speed.

NOTE: When operating the tractor be certain that the throttle lever is always in the FAST  position. Operating with the throttle at less than full throttle may lead to shortened battery life and poor cut quality.

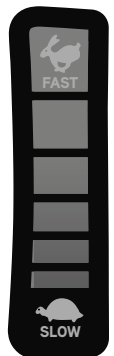

Brake Pedal

The brake pedal is located on the left front side of the tractor. The brake pedal can be used for sudden stops or setting the parking brake.

NOTE: The brake pedal must be fully depressed to activate the safety interlock switch when starting the tractor.



Manual Lift Lever (If so equipped)



The lift lever is located in the right fender and is used to raise and lower the deck. Pull the handle to the left out of the index notch and push downward to lower the deck, or pull upward to raise the deck. When the desired height is attained, move the lift handle to the right until fully in the index notch.

Electric Lift Switch (If so equipped)



The electric lift switch located in the right fender and is used to raise and lower the deck. To lower the deck press down on the front of the switch and to raise the deck push down on the rear of the switch.

Cutting Height Lever (If so equipped)



The cutting height lever is used to set the distance the deck can be lowered. The cutting height lever can be set to six different positions by moving the lever up or down to the desired setting.

Ignition Switch Module



WARNING! Never leave a running machine unattended. Always disengage

PTO, set parking brake, stop engine and remove key to prevent unintended starting.

To start the engine, insert the key into the ignition switch and turn clockwise to the START position. Release the key into the NORMAL MOWING MODE position once the engine has fired.

To stop the engine, turn the ignition key counterclockwise to the STOP position.



CAUTION: Prior to operating the tractor, refer to both Safety Interlock Switches and Starting The Engine in the Operation section of this manual for detailed instructions regarding the Ignition Switch Module and operating the tractor in REVERSE

CAUTION MODE

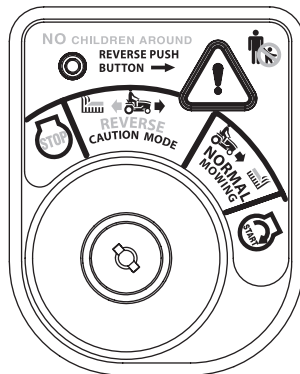

Forward Drive Pedal

The forward drive pedal is located on the right side of the tractor, along the running board. Press the drive pedal forward to cause the tractor to travel forward. Ground speed is also controlled with the drive pedal. The further forward the pedal is pivoted, the faster the tractor will travel. The pedal will return to its original position when it's not pressed.



Reverse Pedal

The reverse drive pedal is located on the right side of the tractor along the running board. Ground speed is also controlled with the reverse pedal. The further downward the pedal is pivoted, the faster the tractor will travel. The pedal will return to its original position when it's not pressed.

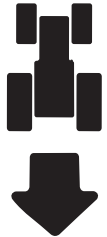

PTO/Blade Engage Lever

Activating the PTO engages power to the cutting deck or other (separately available) attachments. Lift up on the PTO/Blade Engage lever to activate it. Push down on the PTO/ Blade Engage lever to disengage the power to the cutting deck or other (separately available) attachments.



NOTE: The PTO/Blade Engage lever must be in the disengaged (OFF) position when starting the engine.



Parking Brake/Cruise Control Lever

The parking brake/cruise control lever is located on the left of the tractor's dash panel. It is used to engage the parking brake when the tractor is at rest. Engaging the lever while the tractor is in motion allows the tractor to remain at a constant ground speed without applying pressure to the forward drive pedal. Refer to the Operation section of this manual for detailed instructions regarding the parking brake as well as the cruise control feature.

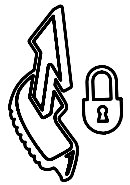

NOTE: Cruise control can NOT be engaged at the tractor's fastest ground speed. If the operator should attempt to do so, the tractor will automatically decelerate to the fastest optimal mowing ground speed



NOTE: The parking brake must be set if the operator leaves the seat with the engine running or the engine will automatically shut off.



WARNING! Never leave a running machine unattended. Always disengage PTO, set parking brake, stop engine and remove key to prevent unintended starting.

Low Gas Window

The low gas window is located at the rear of the tractor. If the gas level is visible in this window, the tank should be re-filled.



FILL TANK IF GAS LEVEL IS SHOWN IN WINDOW



Transmission Bypass Rod

The transmission bypass rod is located at the rear of the tractor on the lower right section of the frame.

When engaged, the rod opens a bypass within the hydrostatic transmissions, which allows the tractor to be pushed short distances by hand. Refer to the Assembly & Set-Up section for instructions on using the bypass feature.

NOTE: If the tractor will not move or does not move freely when pushing check if the bypass lever is fully open.

NOTE: The transmission will NOT engage when the hydrostatic bypass rod is pulled out. Return the rod to its normal position prior to operating the tractor. If the tractor will not move when pushing on the forward/reverse pedals, or moves slowly, check to see if the bypass valve is on.



CAUTION: Never tow your tractor. Towing the tractor with the rear wheels on the ground may cause severe damage to the transmissions.

Hydrostatic Transmission Oil Plug/Dipstick

The hydrostatic transmission oil plug/dipstick is located on the back of the tractor frame and is used to check the level of the hydrostatic transmission oil. The oil fill port is where hydrostatic transmission oil can be added.

Systems Indicator Monitor/Hour Meter

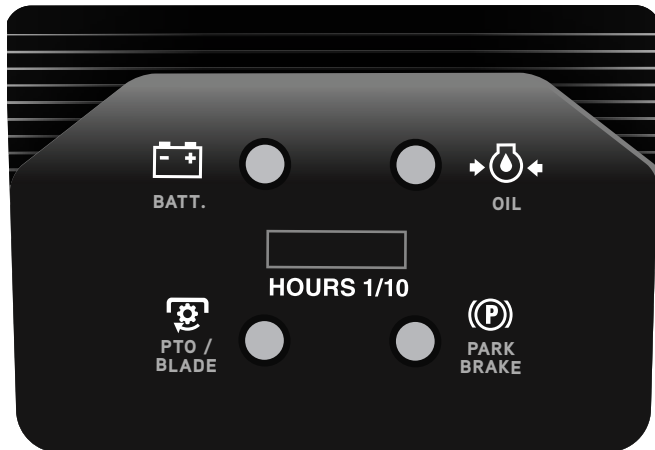

LCD

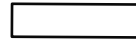

HOURS 1/10

When the ignition key is rotated out of the STOP position but not into the START position, the systems indicator monitor displays the battery's output, in volts, on its LCD for approximately five seconds, after which it displays an hour glass and the hours of tractor operation. Once the tractor is started, the monitor continually displays an hour glass and the hours of tractor operation on its LCD.

NOTE: Hours of tractor operation are recorded any time the ignition key is rotated out of the STOP position, regardless of whether the engine is started.

The Indicator Monitor will also remind the operator of maintenance intervals for changing the engine oil. The LCD will alternately flash the recorded hours, "CHG" and "OIL" for five minutes, after every 50 hours of recorded operation elapse. The maintenance interval lasts for two hours (from 50-52, 100-102, 150-152, etc.). The LCD will also flash as described above for five minutes every time the tractor's engine has been started during this maintenance interval. Before the interval expires, change the engine oil as instructed in the Engine Operator's Manual.

Brake



PARK BRAKE

If the Brake light illuminates when attempting to start the tractor's engine, depress the brake pedal.

PTO (Blade Engage)



PTO / BLADE

If the PTO light illuminates when attempting to start the tractor's engine, move PTO lever into the disengaged (OFF) position.

Oil



OIL

It is normal for the Oil light to illuminate while the engine is cranking during start-up, but if it illuminates during operation, while the engine is running, stop the tractor immediately and check the engine oil level as instructed in this Owner's Manual.

Battery



BATT.

It is normal for the Battery light to illuminate while the engine is cranking during start-up, but if it illuminates during operation, while the engine is running, the battery is in need of a charge or the engine's charging system is not generating sufficient amperage. Charge the battery as instructed in the Service section of this manual or have the charging system checked by your Cub Cadet dealer.



WARNING! Avoid serious injury or death. Go up and down slopes, not across. Avoid sudden turns. Do not operate unit where it could slip or tip. If machine stops going uphill, stop PTO and back down the hill safely. Keep safety devices (guards, shields and switches) in place and working. Remove objects that could be thrown by the blades. Know location and function of all controls. Be sure the blades and the engine are stopped before placing hands or feet near blades. Before leaving operator's position, disengage PTO, engage brake lock, shut off and remove key.

Safety Interlock Switches

This tractor is equipped with a safety interlock system for the protection of the operator. If the interlock system should ever malfunction, do not operate tractor. Contact your Cub Cadet dealer.

- The safety interlock system prevents the engine from cranking or starting unless the parking brake is engaged, and the PTO (Blade Engage) knob is in the disengaged (OFF) position.
- The engine will automatically shut off if the operator leaves the seat before engaging the parking brake.
- The electric PTO (Blade Engage) clutch will automatically shut off if the operator leaves the tractor's seat with the PTO (Blade Engage) knob in the engaged (ON) position, regardless of whether the parking brake is engaged.
- With the ignition key in the NORMAL MOWING position, the electric PTO (Blade Engage) clutch will automatically shut off if the PTO (Blade Engage) knob is moved into the engaged (ON) position with the drive pedal in position for Reverse travel.





WARNING! Do not operate the tractor if the interlock system is malfunctioning. This system was designed for your safety and protection.

Starting the Engine



WARNING! Do not operate the tractor if the interlock system is malfunctioning. This system was designed for your safety and protection.



NOTE: Refer to the Assembly & Set-up section of this manual for Gasoline and Oil fill-up instructions.

1. Insert the tractor key into the ignition switch module.
2. Place the PTO/Blade Engage  lever to OFF position.
3. Engage the tractor's parking brake .
4. Push the choke control upward into the choke on  position.

NOTE: If the engine is warmed up, it may not be necessary to place the choke control in the choke position.

5. Move the throttle control lever to midway between the FAST  and SLOW  positions.

NOTE: When operating the tractor be certain that the throttle lever is always in the FAST  (rabbit) position. Operating with the throttle at less than full throttle may lead to shortened battery life.

6. Turn the ignition key clockwise to the START  position. After the engine starts, release the key. It will return to the NORMAL MOWING  position.



CAUTION: Do NOT hold the key in the START  position for longer than ten seconds at a time. Doing so may cause damage to your engine's electric starter.



6. After the engine starts, deactivate the choke control.

NOTE: Do NOT leave the choke control on while operating the tractor. Doing so will result in a "rich" fuel mixture and cause the engine to run poorly.

Stopping the Engine



WARNING! If you strike a foreign object, stop the engine and disconnect the spark plug wire(s). Thoroughly inspect the machine for any damage. Repair the damage before restarting and operating.

1. If the blades are engaged, place the PTO/Blade Engage lever  in the OFF position.
2. Place the throttle control near the SLOW  position.
3. Turn the ignition key counterclockwise to the STOP  position.
4. Remove the key from the ignition switch to prevent unintended starting.

Reverse Caution Mode

The REVERSE CAUTION MODE  position of the key switch module allows the tractor to be operated in reverse with the blades (PTO) engaged.



NOTE: Mowing in reverse is not recommended.



WARNING! Use extreme caution while operating the tractor in the REVERSE CAUTION MODE . Always look down and behind before and while backing. Do not operate the tractor when children or others are around. Stop the tractor immediately if someone enters the area.

To use the REVERSE CAUTION MODE :

NOTE: The operator **MUST** be seated in the tractor seat.

1. Start the engine as previously instructed on the previous page.
2. Turn the key from the NORMAL MOWING  (Green) position to the REVERSE CAUTION MODE  (Yellow) position of the key switch module. See Figure 5-1.

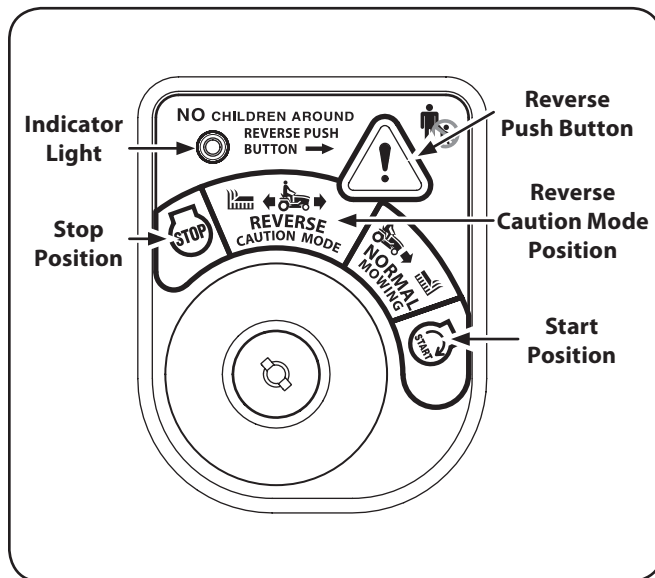





Figure 5-1

3. Press the REVERSE PUSH BUTTON  at the top, right corner of the key switch module. The red indicator light at the top, left corner of the key switch module will be ON while activated. See Figure 5-1.
4. Once activated (indicator light ON), the tractor can be driven in reverse with the cutting blades (PTO) engaged.
5. Always look down and behind before and while backing to make sure no children are around. After resuming forward motion, return key to the NORMAL MOWING  position.





The REVERSE CAUTION MODE  will remain activated until:

- a. The key is placed in either the NORMAL MOWING  position or STOP  position or
- b. The operator leaves the seat.

Driving The Tractor



WARNING! Avoid sudden starts, excessive speed and sudden stops.

1. Lightly press the brake pedal  to release the parking brake . Move the throttle lever into the FAST  position.
2. To travel FORWARD, slowly press the forward drive pedal  forward until the desired speed is achieved. See Figure 5-2.

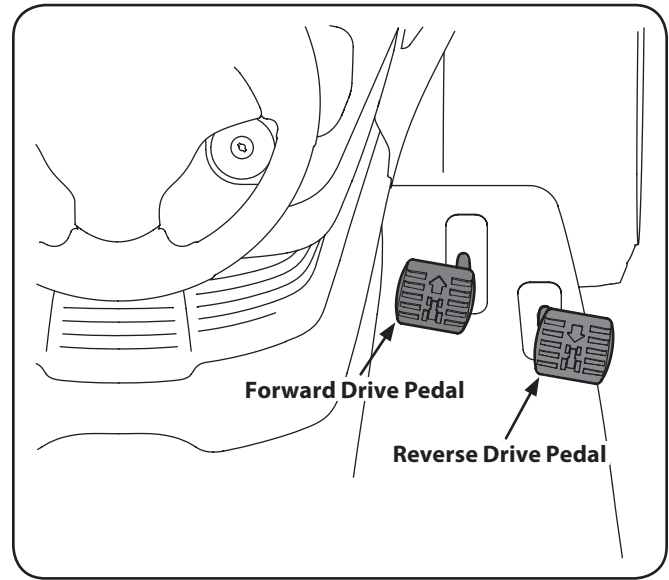



Figure 5-2

3. To travel in REVERSE, check that the area behind is clear then slowly depress the reverse drive pedal  until the desired speed is achieved. See Figure 5-2.



CAUTION: Do NOT attempt to change the direction of travel when the tractor is in motion. Always bring the tractor to a complete stop before changing from forward to reverse or vice versa.



WARNING! Do not leave the seat of the tractor without first placing the PTO/Blade Engage lever in the OFF position and engaging the parking brake. If leaving the tractor unattended, also turn the engine off and remove the ignition key.

Driving On Slopes

Refer to the SLOPE GAUGE on page 8 to help determine slopes where you may operate the tractor safely.



WARNING! Do not mow on inclines with a slope in excess of 15 degrees (a rise of approximately 2-1/2 feet every 10 feet). The tractor could overturn and cause serious injury.

- Mow up and down slopes, NEVER across.
- Exercise extreme caution when changing direction on slopes.
- Watch for holes, ruts, bumps, rocks, or other hidden objects. Uneven terrain could overturn the machine. Tall grass can hide obstacles.
- Avoid turns when driving on a slope. If a turn must be made, turn down the slope. Turning up a slope greatly increases the chance of a roll over.
- Avoid stopping when driving up a slope. If it is necessary to stop while driving up a slope, start up smoothly and carefully to reduce the possibility of flipping the tractor over backward.

Engaging the Parking Brake

NOTE: The parking brake must be set if the operator leaves the seat with the engine running or the engine will automatically shut off.

To set the parking brake:

1. Press the brake pedal (○) completely down with your left foot and hold it in that position.
2. Lift the parking brake/cruise control lever (P) upward and hold it in that position.
3. Remove your foot from the brake pedal (○).
4. Release pressure from the parking brake/cruise control lever (P).

After completing step 3, the brake pedal should remain in the down position. If it doesn't, the parking brake is *not* engaged. Repeat steps 1-4 to engage the parking brake.

To disengage the parking brake, lightly press the brake pedal .



WARNING! Never leave a running machine unattended. Always disengage PTO, set parking brake, stop engine and remove key to prevent unintended starting

Setting The Cruise Control



WARNING! Never engage the cruise control lever while traveling in reverse.

To set the cruise control:

1. Slowly press the forward drive pedal (↑) with your right foot until the desired speed is achieved.
2. Lift the parking brake/cruise control lever (P) upward and hold it in that position.
3. Remove your foot from the forward drive pedal (↑).
4. Release pressure from the parking brake/cruise control lever (P).

After completing step 3, the forward drive pedal should remain in the down position and the tractor will maintain the same forward speed. If it doesn't, the cruise control is *not* engaged. Repeat steps 1-4 to engage the cruise control.

To disengage the cruise control, lightly press the forward drive pedal (↑) or the brake pedal (○).

NOTE: Cruise control can not be set at the tractor's fastest ground speed. If the operator should attempt to do so, the tractor will automatically decelerate to the fastest optimal mowing ground speed.

To change the direction of travel from forward to reverse when cruise control is engaged, press the brake pedal to disengage the cruise control and bring the tractor to a complete stop. Then slowly press the reverse drive pedal with the ball of your foot to travel in reverse.

Using the Lift Lever

Manual Lift Lever (If so equipped)

To raise or lower the cutting deck, move the lift lever to the left, then place it in the notch best suited for your application.

Electric Lift Switch (If so equipped)

When operating the tractor's electric lift switch, always complete the following steps.



1. Press down on the rear of the lift switch to raise the deck *all the way* into its highest position.
2. Position the cutting height lever in the desired setting.
3. Press down on the front of the lift switch to lower the deck into the position set in the previous step.

NOTE: The deck will automatically stop lowering when it reaches the point determined by the position of the cutting height lever.





CAUTION: Failure to follow these instructions when operating the tractor's electric lift switch *will* result in premature wear of the tractor's electric lift system.

Operating the Headlights

The lamps are ON whenever the ignition key is rotated out of the STOP  position. The lamps turn OFF when the ignition key is moved to the STOP  position.

Engaging the PTO

Engaging the PTO transfers power to the cutting deck or other (separately available) attachments. To engage the PTO:

1. Move the throttle control lever to the FAST  position.
2. Pull the PTO/Blade Engage lever  upward into the ON position. See Figure 5-3.

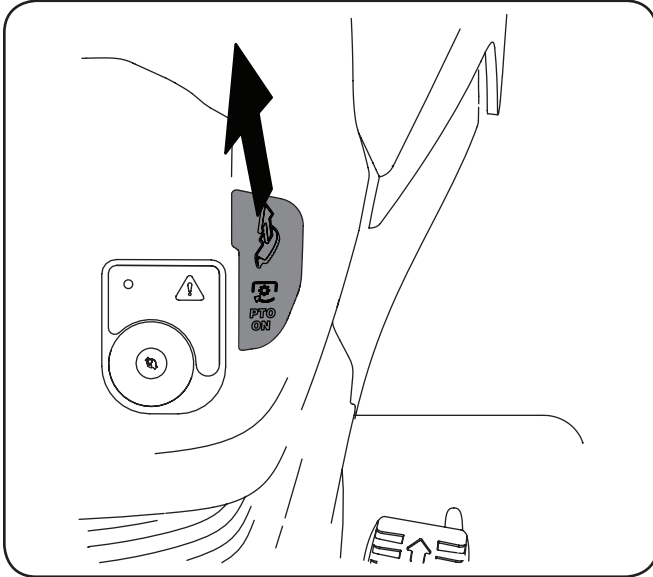



Figure 5-3

NOTE: When operating the tractor be certain that the throttle lever is always in the FAST  (rabbit) position. Operating with the throttle at less than full throttle may lead to premature battery wear and a poor quality cut.

Maintenance Schedule

| | Before Each use | Every 10 Hours | Every 25 Hours | Every 200 Hours | Prior to Storing |
|------------------------------------|-----------------|----------------|----------------|-----------------|------------------|
| Check/Clean Engine Intake Screen | ✓ | | | | ✓ |
| Clean Hood/Dash Louvers | | ✓ | | | ✓ |
| Check Engine Oil Level | ✓ | | | | |
| Check Transmission Oil | ✓ | | | | |
| Change Transmission Oil & Filter * | | | | ✓ | |
| Clean Battery Terminals | | ✓ | | | ✓ |
| Lube Front Axles and Rims | | | ✓ | | ✓ |
| Lube Pedal Pivot Points | | | ✓ | | ✓ |

* — For break-in operation, change after the first 50 hours of use and then every 200 hours thereafter.

NOTE: This Operator's Manual covers several models. Tractor features may vary by model. Not all features in this manual are applicable to all tractor models and the tractor depicted may differ from yours.



WARNING! Before performing any maintenance or repairs, disengage PTO, set parking brake, stop engine and remove key to prevent unintended starting.

Battery



CALIFORNIA PROPOSITION 65 WARNING! Battery posts, terminals, and related accessories contain lead and lead compounds, chemicals known to the State of California to cause cancer and reproductive harm. Wash hands after handling.

The battery is sealed and is maintenance-free. Acid levels cannot be checked and fluid can not be added.

- Always keep the battery cables and terminals clean and free of corrosive build-up.
- After cleaning the battery and terminals, apply a light coat of petroleum jelly or grease to both terminals.



CAUTION: If removing the battery for cleaning, disconnect the NEGATIVE (Black) wire from its terminal first, followed by the POSITIVE (Red) wire. When re-installing the battery, always connect the POSITIVE (Red) wire its terminal first, followed by the NEGATIVE (Black) wire. Be certain that the wires are connected to the correct terminals; reversing them could result in serious damage to your engine's alternating system.

Engine

Refer to the Kohler Owner's Manual for all engine maintenance procedures and instructions.

Changing the Engine Oil



WARNING! If the engine has been recently run, the engine, muffler and surrounding metal surfaces will be hot and can cause burns to the skin. Exercise caution to avoid burns.

To complete an oil change, proceed as follows:

1. Run the engine for a short time to warm the engine oil. The oil will flow more freely and carry away more impurities. Use care to avoid burns from hot oil.
2. Locate the oil drain hose on the left side of the engine.
3. Remove the hose from the retaining loop-clip. Route the free end of the oil drain hose toward an appropriate oil collection container with at least a 2.5 quart capacity, to collect the used oil. Remove the oil fill cap/dipstick from the oil fill tube.

- While holding the free end of the oil drain hose over the oil collection container, unscrew the square head hose plug from the end of the hose. See Figure 6-1. Drain the engine oil into the collection container.

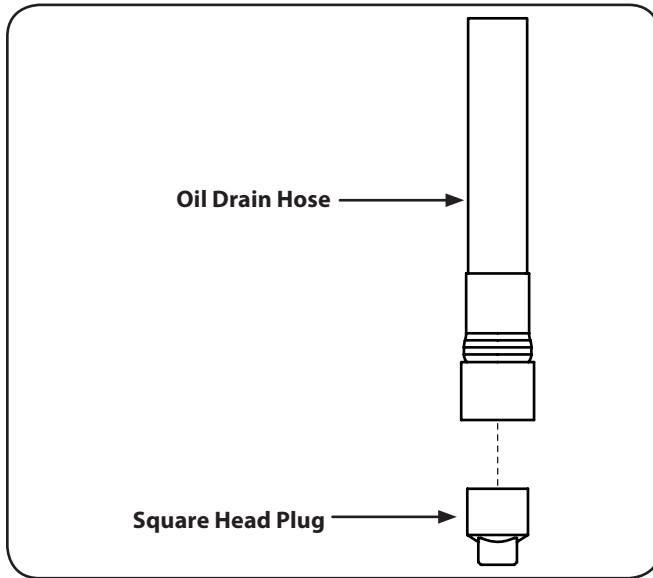

Figure 6-1

- After draining the oil, wipe any residual oil from the oil drain hose. Thread the square head plug into the drain hose fitting and fully tighten the plug.
- Replace the oil filter, and refill the engine with new oil as instructed in the Kohler Owner's Manual.
- Re-insert hose through the retaining loop-clamp.

To refill the oil, re-install the square head plug at the end of the hose and refer to the Engine Operator's Manual for refilling instructions, oil type and amount.

NOTE: Maintenance, repair, or replacement of the emission control devices and systems which are being done at owner's expense may be performed by any engine repair establishment or individual.

Warranty repairs must be performed by a Cub Cadet Dealer.

Hydrostatic Transmission Oil

Checking the Hydrostatic Transmission Oil

The dipstick to check the hydrostatic transmission oil level is located on the back of the mower on the upper section of the frame. Refer to the Controls & Features section of this manual.

- Remove the dipstick and check the level. See Figure 6-2.

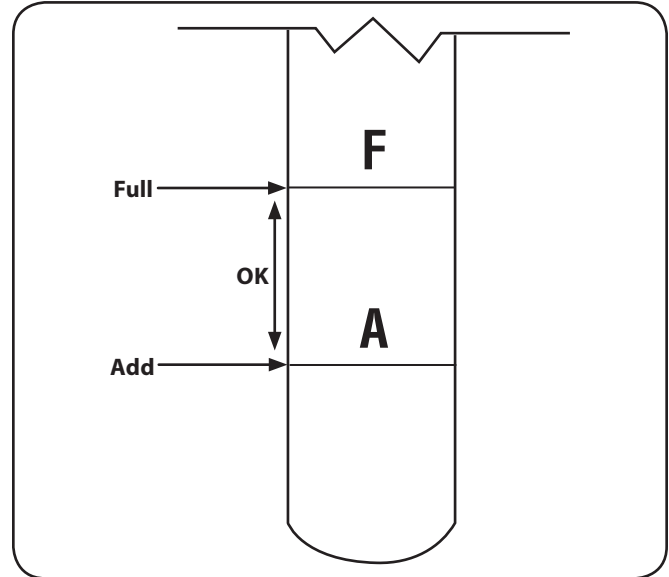

Figure 6-2

- If the level is above the "ADD" level and in the "OK" range, it is not necessary to add any transmission oil. If the level is at or below the "ADD" level add transmission oil into the oil fill port until the level is in the "OK" range. For best results, fill to the "FULL" mark on the dipstick as opposed to adding a specific volume of oil. Do NOT overfill.

NOTE: The approved fluid is *Cub Cadet Drive System Fluid Plus*. (1 quart — Part No. 737-3120/1 gallon — 737-3121).

- Reinstall the transmission oil fill plug/dipstick securely into the oil fill port.
- Start the engine and allow it to run for a few minutes. Shut the engine off, then check for leaks and re-check the oil level in the transmission case.

Changing the Hydrostatic Transmission Oil



CAUTION: Never overfill the transmission case. Damage or leakage may result if the oil level in the transmission case is below the "ADD" mark or over the "FULL" mark of the dipstick.

- Place the tractor on a level surface and engage the brake pedal lock. Stop the tractor engine and remove the ignition key.
- Clean the area around the transmission drain plug to prevent debris from entering the transmission case.

- Remove the drain plug and allow the transmission oil to drain into a clean container having a capacity of more than six quarts. Reinstall the drain plug. See Figure 6-3.

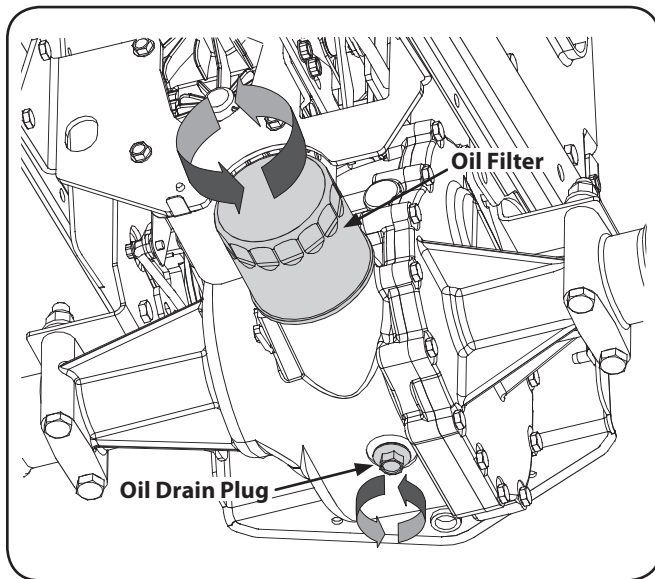

Figure 6-3

- Clean around the base of the transmission oil filter and remove the filter by turning it counterclockwise. Refer to Figure 6-3.
- Apply a light coating of clean transmission oil to the gasket of the new filter. Install the filter by turning it clockwise, by hand. When the gasket contacts the filter base on the transmission housing, tighten the filter an additional ½-turn.
- Clean the area around the transmission oil fill plug/dipstick to prevent debris from entering the transmission case.
- Remove the oil fill plug/dipstick from the oil fill port and SLOWLY pour oil into the oil fill port. Fill the transmission case until the oil level reaches the "FULL" mark on the dipstick. Refer to Figure 6-2.

NOTE: The transmission has a capacity of approximately 5-½ quarts.

- Reinstall the oil fill plug/dipstick securely into the oil fill port.
- Start the engine and allow it to run for a few minutes. Shut the engine off, then check for leaks and re-check the oil level in the transmission case.



CAUTION: The transmission oil fill plug/dipstick must be installed securely into the fill port at all times when the engine is operating.

Hydrostatic Neutral Adjustment

If the tractor creeps forward or rearward when neither the forward nor reverse pedal is depressed, contact your local Cub Cadet dealer to have the hydrostatic control rods properly adjusted.

Cleaning the Tractor

Any fuel or oil spilled on the machine should be wiped off promptly. Do NOT allow debris to accumulate around the cooling fins of the engine, the transmission's cooling fan or on any other part of the machine.

Cleaning the Engine Intake Screen

The engine intake screen area is located on the lower half of the dash. It is important to keep this area free of debris. Clean this area prior to each use. See Figure 6-4.

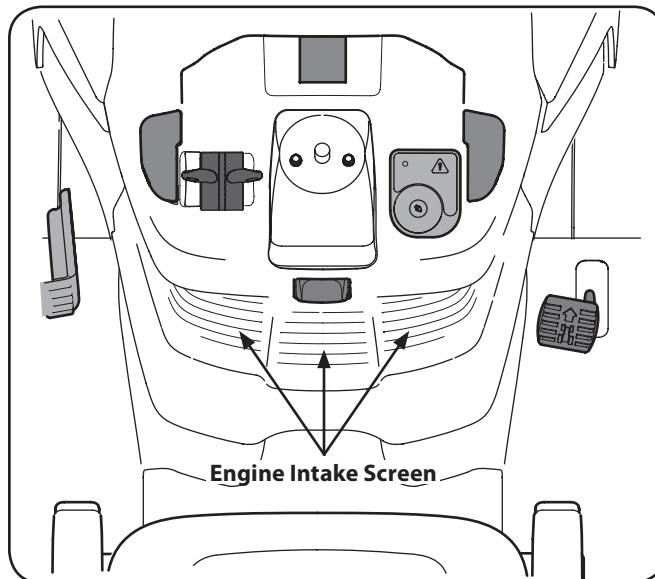

Figure 6-4

Lubrication



WARNING! Before lubricating, repairing, or inspecting, always disengage PTO, set parking brake, stop engine and remove key to prevent unintended starting.

Steering Housing & Steering Shaft

The steering housing and steering shaft should be lubricated after every 25 hour of operation. To access the lube fittings, proceed as follows:

1. Raise the tractor's hood.
2. Locate the grease fitting for the steering housing and steering shaft under the battery. See Figure 6-5.

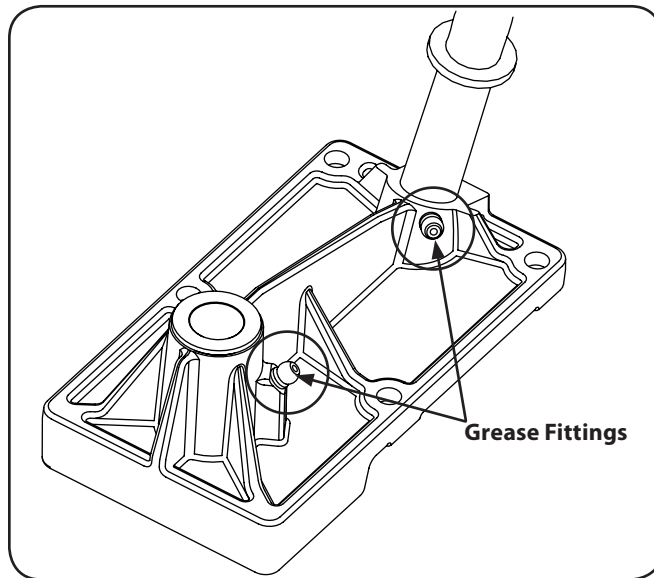

Figure 6-5

3. Using a pressure lubricating gun, apply 251H EP grease, or an equivalent No. 2 multipurpose lithium grease, through the grease fittings.
4. Close the tractor hood

Deck Wheels

Each of the tractor deck's gauge wheels is equipped with a grease fitting. Lubricate with a No. 2 multi-purpose grease applied with a grease gun after every 25 hours of tractor operation.

Pivot Points & Linkage

Lubricate all the pivot points on the drive system, parking brake and lift linkage at least once a season with light oil.

Adjustments



WARNING! Shut the engine off, remove the ignition key and engage the parking brake before making adjustments. Protect your hands by using heavy gloves when handling the blades.

NOTE: Check the tractor's tire pressure before performing any deck leveling adjustments. Refer to Tires on page 10 for information regarding tire pressure.

Seat Adjustment

Refer to the Assembly & Set-Up section of this manual for seat adjustment instructions.



WARNING! Before operating the tractor, make sure the seat is engaged in the seat-stop. Engage the parking brake. Stand behind the machine and pull back on seat until it clicks into place.

Parking Brake Adjustment

If the tractor does not come to a complete stop when the brake pedal is completely depressed, or if the tractor's rear wheels can roll with the parking brake applied (and the hydrostatic relief valve open), the brake is in need of adjustment. See your Cub Cadet dealer to have the brake adjusted.

Wheel Alignment

The front wheels should toe-in approximately $\frac{1}{8}$ to $\frac{1}{4}$ " , as measured across dimensions A and B. See Figure 6-6.

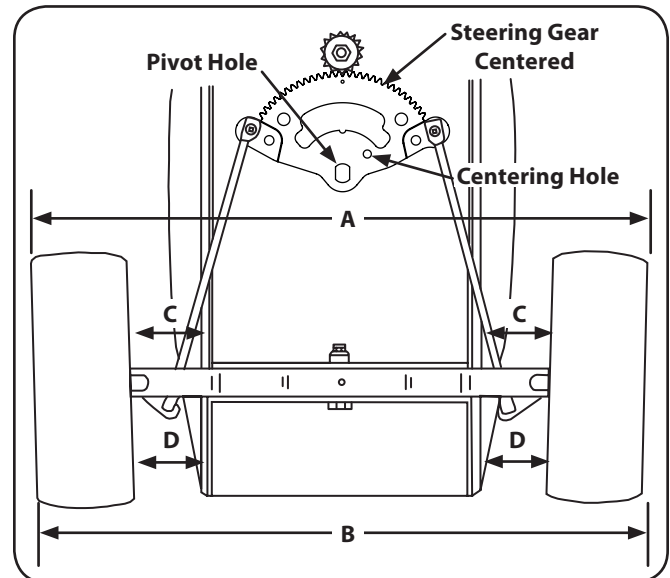

Figure 6-6

Steering/Toe-in Adjustment

To adjust front wheel toe-in, proceed as follows:

1. Check the steering gear to ensure it is in the centered position. The hole in the steering segment gear will align with the hole in the steering housing (See Figure 6-6).
NOTE: A $\frac{5}{16}$ " pin can be used in the alignment holes to assure the steering segment is centered.
2. Mark the front horizontal diameter of both front wheels at the same spot on each wheel-preferably the inner bead flange of the wheel rims. Mark the rear horizontal diameter of both front wheels in the same manner.
3. Measure the distance between the bottom edges of the tractor frame channels and the marks on the front of each wheel (See measurement D in Figure 6-6). These two measurements should be equal.
4. Measure the distance between the frame and the marks on the rear of each front wheel (See measurement C in Figure 6-6). Measurement D should be approximately $\frac{1}{16}$ - to $\frac{1}{8}$ -inch less than measurement C on each side of the tractor.

- Loosen the jam nuts from the ball joints. See Figure 6-7.

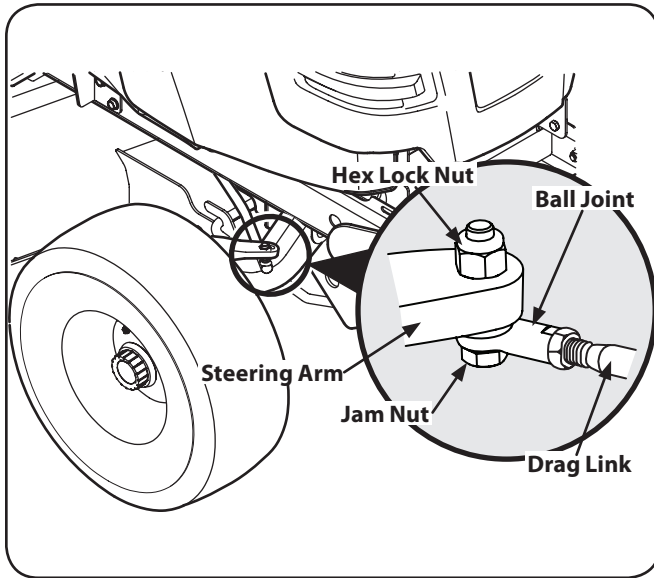

Figure 6-7

- Disconnect the front ball joints from the steering arms by removing the hex lock nuts. Refer to Figure 6-7. Manually move each wheel to achieve the required toe-in and equal D measurements.
- Making sure not to move the steering gear or either wheel, turn the ball joint in or out on each drag link as necessary to align with the hole in each steering arm.
- Reinstall the ball joints in the steering arms and secure with the hex lock nuts. Tighten the jam nuts against the ball joints.

Pivot Bar Adjustment



CAUTION: The tractor should be checked every 50 hours of operation for play between the frame channel and the pivot bar.

Check and adjust the pivot axle as follows:

- Raise the front of the tractor and set it on jack stands, so the front wheels are suspended above the ground.



WARNING! When jacking up the front end of the tractor, always chock the rear wheels to prevent the tractor from rolling, tipping or sliding off the jack stands.

- Move the ends of the pivot bar up and down to check for binding. If binding is present, loosen the lock nuts until binding is eliminated. See Figure 6-8.

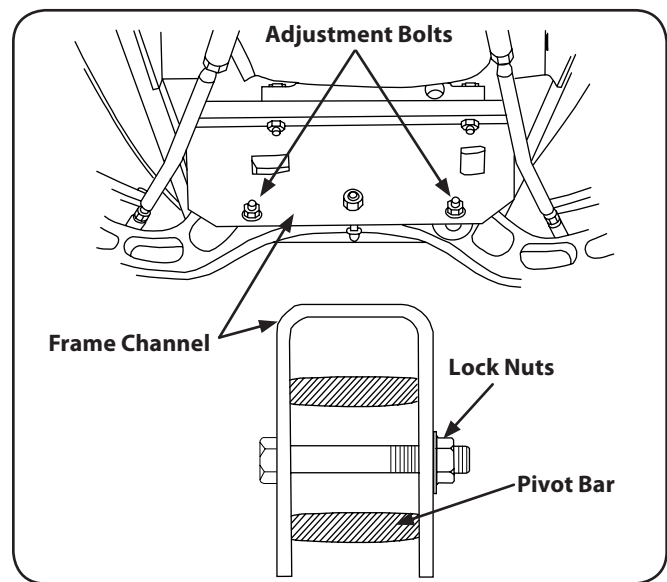

Figure 6-8

- Grasping the ends of the pivot bar, attempt to move each end of the axle forward and rearward to check for side play between the pivot bar and frame channel. If play is present, gradually tighten the lock nuts until play is minimized.
- Repeat steps 2 and 3 until minimum play without binding is achieved.
- Raise the front of the tractor, remove jack stands, and lower the tractor to the ground. Remove the blocks from the rear wheels.

Lift Handle Adjustment (If so equipped)

The effort required to operate the implement lift handle can be varied by loosening or tightening the lift assist spring adjusting bolt on the left side of the tractor. See Figure 6-9.

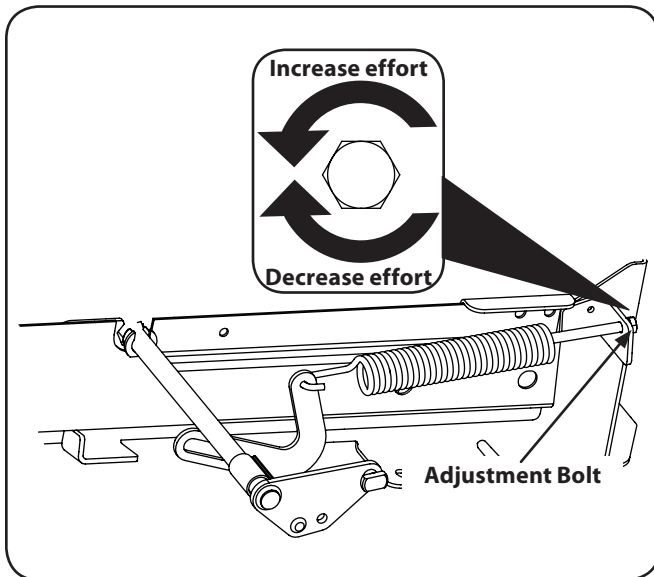

Figure 6-9

NOTE: The deck and/or attachment should be installed before making adjustments to this spring.

Place the deck/attachment into the lowest position for making adjustments. This ensures that the spring is extended the furthest.

The bolt can be accessed from the rear of the tractor, inside the left rear wheel. Turning adjusting bolt clockwise will decrease the manual effort required for lifting attachments; turning counterclockwise will increase the effort needed to lift the attachment.

NOTE: Overtightening of the spring could cause the deck to float and/or fail out of the notches. There should always be a downward/forward bias on the lever for proper operation.

Battery

Common Causes For Battery Failure

1. Overcharging
2. Undercharging
3. Loose and/or corroded connections
4. Excessive loads
5. Freezing of electrolyte

* These causes do not constitute warranty in the event of a battery failure.

Battery Removal or Installation



WARNING! Battery posts, terminals and related accessories contain lead and lead compounds. Wash Hands after handling.

When removing the battery, disconnect the battery cables in the following order to avoid arcing and the resulting sparks:

Battery Removal

1. Disconnect the Negative cable.
2. Disconnect the Positive cable.

When installing the battery, connect the battery cables in the following order:

Battery Installation

1. Connect the Positive cable.
2. Connect the Negative cable.

To replace the battery, proceed as follows:

1. Remove the negative cable from the negative terminal of the battery, then remove positive cable from the positive terminal.
2. Remove the hex screw securing the LH side of the hold down rod to the battery tray. See Figure 7-1.

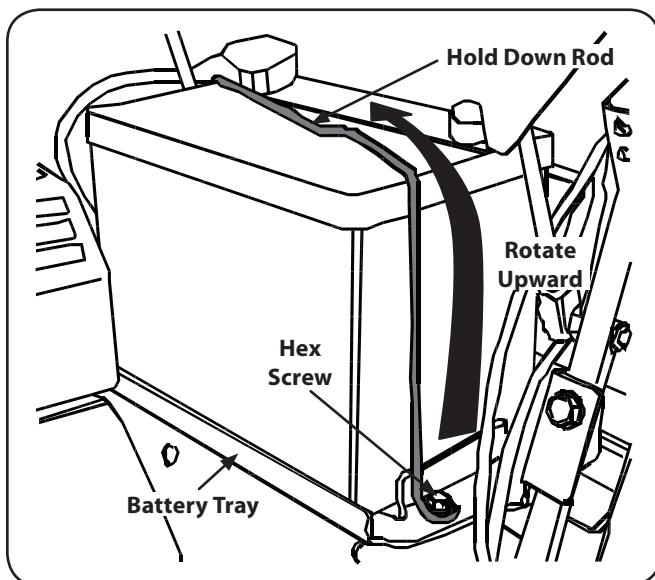

Figure 7-1

3. Note which battery tray hole the RH side of the hold-down rod is hooked into.
4. Rotate the hold-down rod upward, over and around the battery to unhook from the battery tray.
5. Lift the battery out off the battery tray and remove from the tractor.
6. Position the new battery and lower into the battery tray.
7. Hook the hold-down rod into the previously noted battery tray hole, then rotate the rod around and over the battery.
8. Align the LH side of the hold-down rod with the hole in the battery tray and secure with hex screw remove earlier.
9. Connect the positive cable to the positive terminal of the battery, then connect the negative cable to the negative terminal.

Charging The Battery

Test and, if necessary, recharge the battery after the tractor has been stored for a period of time.

- A voltmeter or load tester should read 12.6 volts (DC) or higher across the battery terminals. See Figure 7-2.

| Voltmeter Reading | State of Charge | Charging Time |
|-------------------|-----------------|---------------|
| 12.7 | 100% | Full Charge |
| 12.4 | 75% | 90 Min. |
| 12.2 | 50% | 180 Min. |
| 12.0 | 25% | 280 Min. |

Figure 7-2

- Charge the battery with a 12-volt battery charger at a MAXIMUM rate of 10 amps.

Headlights

Refer to Replacement Parts section when replacement of head lamp bulbs is necessary.

Replace headlight bulbs as follows:

1. Fully raise the hood of the tractor.
2. Unplug the wire harness leads from the headlight socket terminals. Note which wire connects to each terminal before disconnecting.
3. Rotate the socket assembly approximately $\frac{1}{4}$ turn to align the socket tab with the reflector housing notch; then withdraw the bulb and socket assembly from the reflector housing. See Figure 7-3.

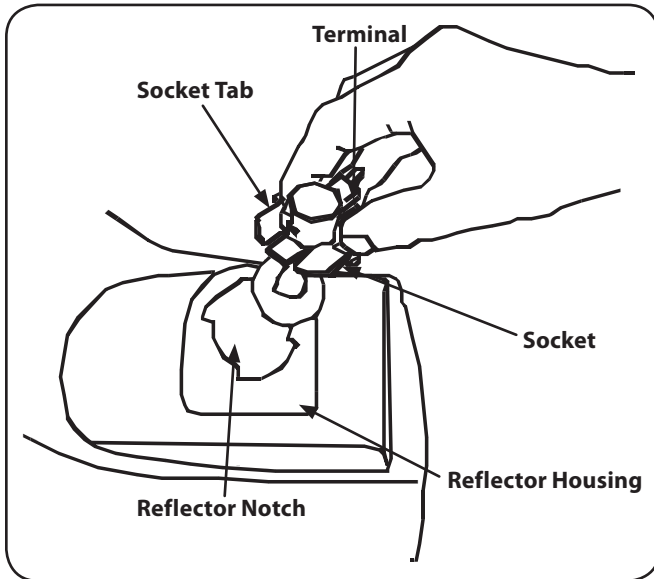

Figure 7-3





4. Push the bulb inward and turn counterclockwise to remove from the socket.
5. Align a locking post of the bulb base with the notch in the socket, then push the bulb inward and turn clockwise to lock. See Figure 7-3.
6. Align the socket tab with the notch of the reflector housing; then push the socket inward and turn as necessary to lock the socket in the housing:
7. Connect the wire harness leads to the appropriate socket terminals.

Fuses

Always use the same capacity fuse for replacement. If the electrical system does not function, check the fuses.

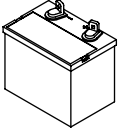
To replace a fuse, pull the old fuse from the fuse holder and install the new fuse.

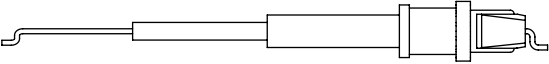
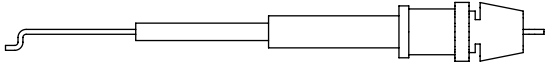
| Problem | Cause | Remedy |
|--|---|--|
| Excessive vibration | <ol style="list-style-type: none"> 1. Cutting blade loose or unbalanced. 2. Damaged or bent cutting blade. | <ol style="list-style-type: none"> 1. Tighten blade and spindle. 2. Replace blade. |
| Mower will not mulch grass (If equipped) | <ol style="list-style-type: none"> 1. Engine speed too low. 2. Wet grass. 3. Excessively high grass. 4. Dull blade. | <ol style="list-style-type: none"> 1. Place throttle in FAST (rabbit) position. 2. Do not mulch when grass is wet. 3. Mow once at a high cutting height, then mow again at desired height or make a narrower cutting swath. 4. Sharpen or replace blade. |
| Uneven cut | <ol style="list-style-type: none"> 1. Deck not leveled properly. 2. Dull blade. 3. Uneven tire pressure. | <ol style="list-style-type: none"> 1. Perform side-to-side deck adjustment. 2. Sharpen or replace blade. 3. Check tire pressure in all four tires. |

| Component | Part Number and Description |
|---|--|
|  | 925-1707D Battery |
|  | 951-12725 Fuel Cap |
|  | 946-04759A Choke Control Cable |
|  | 946-04771A Throttle Control Cable |
|  | 925-2054A Ignition Key |
|  | 925-0963 12V Bulb |

Phone (800) 965-4CUB to order replacement parts or a complete Parts Manual (have your full model number and serial number ready). Parts Manual downloads are also available free of charge at www.cubcadet.com.

GTX2100

The following attachments and accessories are compatible for Cub Cadet GTX2100. See your Cub Cadet dealer or the retailer from which you purchased your tractor for information regarding price and availability.

| Model Number | Description |
|--------------|--------------------------|
| 19A40012100 | 42" Staggered Deck |
| 19A40015100 | 48" Fabricated Deck |
| 19A40013100 | 50" Stamped Deck |
| 19A40016100 | 54" Fabricated Deck |
| 19A40014100 | 54" Stamped Deck |
| 19A40022100 | 46" Snow Blade |
| 19A40019100 | 44" Snow Thrower |
| 19A40022100 | 46" Snow Thrower |
| 19A40021100 | 42" Mulch Kit |
| 19A70016100 | 48" Fabricated Mulch Kit |
| 190-193-000 | 50" Mulch Kit |
| 19A70023100 | 54" Fabricated Mulch Kit |
| 590-507-100 | 54" Stamped Mulch Kit |
| 19A40003100 | Twin Bagger |
| 19A40004100 | Triple Bagger |
| 190-307-100 | Weight Kits |
| 490-241-0026 | Tire Chains |
| 490-850-0008 | Oil Siphon |
| 490-850-0005 | Blade Removal Tool |

GT2000 & GTX2000

The following attachments and accessories are compatible for Cub Cadet GT2000. See your Cub Cadet dealer or the retailer from which you purchased your tractor for information regarding price and availability.

| Model Number | Description |
|--------------|--------------------------|
| 19A40012100 | 42" Staggered Deck |
| 19A40013100 | 50" Stamped Deck |
| 19A40014100 | 54" Stamped Deck |
| 19A40022100 | 46" Snow Blade |
| 19A40019100 | 44" Snow Thrower |
| 19A40022100 | 46" Snow Thrower |
| 19A40021100 | 42" Mulch Kit |
| 19A70016100 | 48" Fabricated Mulch Kit |
| 190-193-000 | 50" Mulch Kit |
| 19A70023100 | 54" Fabricated Mulch Kit |
| 590-507-100 | 54" Stamped Mulch Kit |
| 19A40003100 | Twin Bagger |
| 19A40004100 | Triple Bagger |
| 190-307-100 | Weight Kits |
| 490-241-0026 | Tire Chains |
| 490-850-0008 | Oil Siphon |
| 490-850-0005 | Blade Removal Tool |

FEDERAL and/or CALIFORNIA EMISSION CONTROL WARRANTY STATEMENT
YOUR WARRANTY RIGHTS AND OBLIGATIONS

MTD Consumer Group Inc, the United States Environmental Protection Agency (EPA), and, for those products certified for sale in the state of California, the California Air Resources Board (CARB) are pleased to explain the emission (evaporative and/or exhaust) control system (ECS) warranty on your outdoor 2006 and later small off-road spark-ignited engine and equipment (outdoor equipment engine) In California, new outdoor equipment engines must be designed, built and equipped to meet the State's stringent anti-smog standards (in other states, 1997 and later model year equipment must be designed, built, and equipped to meet the U.S. EPA small off-road, spark ignition engine regulations. MTD Consumer Group Inc must warrant the ECS on your outdoor equipment engine for the period of time listed below provided there has been no abuse, neglect or improper maintenance of outdoor equipment engine.

Your ECS may include parts such as the carburetor, fuel-injection system, the ignition system, catalytic converter, fuel tanks, fuel lines, fuel caps, valves, canisters, filters, vapor hoses, clamps, connectors, and other associated emission-related components.

Where a warrantable condition exists, MTD Consumer Group Inc will repair your outdoor equipment engine at no cost to you including diagnosis, parts and labor.

MANUFACTURER'S WARRANTY COVERAGE:

This emission control system is warranted for two years. If any emission-related part on your outdoor equipment engine is defective, the part will be repaired or replaced by MTD CONSUMER GROUP INC.

OWNER'S WARRANTY RESPONSIBILITIES:

As the outdoor equipment engine owner, you are responsible for performance of the required maintenance listed in your owner's manual. MTD Consumer Group Inc recommends that you retain all receipts covering maintenance on your outdoor equipment engine, but MTD Consumer Group Inc cannot deny warranty solely for the lack of receipts.

As the outdoor equipment engine owner, you should however be aware that MTD Consumer Group Inc may deny you warranty coverage if your outdoor equipment engine or a part has failed due to abuse, neglect, or improper maintenance or unapproved modifications.

You are responsible for presenting your outdoor equipment engine to MTD Consumer Group Inc's distribution center or service center as soon as the problem exists. The warranty repairs should be completed in a reasonable amount of time, not to exceed 30 days. If you have a question regarding your warranty coverage, you should contact the MTD Consumer Group Inc Service Department at 1-800-800-7310 or via email at <http://support.mtdproducts.com>

GENERAL EMISSIONS WARRANTY COVERAGE:

MTD Consumer Group Inc warrants to the ultimate purchaser and each subsequent purchaser that the outdoor equipment engine is: Designed, built and equipped so as to conform with all applicable regulations; and free from defects in materials and workmanship that cause the failure of a warranted part to be identical in all material respects to that part as described in MTD Consumer Group Inc's application for certification.

The warranty period begins on the date the outdoor equipment engine is delivered to an ultimate purchaser or first placed into service. The warranty period is two years.

Subject to certain conditions and exclusions as stated below, the warranty on emission-related parts is as follows:

1. Any warranted part that is not scheduled for replacement as required maintenance in the written instructions supplied, is warranted for the warranty period stated above. If the part fails during the period of warranty coverage, the part will be repaired or replaced by MTD Consumer Group Inc according to subsection (4) below. Any such part repaired or replaced under warranty will be warranted for the remainder of the period.
 2. Any warranted part that is scheduled only for regular inspection in the written instructions supplied is warranted for the warranty period stated above. Any such part repaired or replaced under warranty will be warranted for the remaining warranty period.
 3. Any warranted part that is scheduled for replacement as required maintenance in the written instructions supplied is warranted for the period of time before the first scheduled replacement date for that part. If the part fails before the first scheduled replacement, the part will be repaired or replaced by MTD Consumer Group Inc according to subsection (4) below. Any such part repaired or replaced under warranty will be warranted for the remainder of the period prior to the first scheduled replacement point for the part.
 4. Repair or replacement of any warranted part under the warranty provisions herein must be performed at a warranty station at no charge to the owner.
 5. Notwithstanding the provisions herein, warranty services or repairs will be provided at all of our distribution centers that are franchised to service the subject engines or equipment.
 6. The outdoor equipment engine owner will not be charged for diagnostic labor that is directly associated with diagnosis of a defective, emission-related warranted part, provided that such diagnostic work is performed at a warranty station.
 7. MTD Consumer Group Inc is liable for damages to other engine or equipment components proximately caused by a failure under warranty of any warranted part.
 8. Throughout the off-road engine and equipment warranty period stated above, MTD Consumer Group Inc will maintain a supply of warranted parts sufficient to meet the expected demand for such parts.
 9. Any replacement part may be used in the performance of any warranty maintenance or repairs and must be provided without charge to the owner. Such use will not reduce the warranty obligations of MTD Consumer Group Inc.
-

-
10. Add-on or modified parts that are not exempted by the Air Resources Board may not be used. The use of any non-exempted add-on or modified parts by the ultimate purchaser will be grounds for disallowing a warranty claims. MTD Consumer Group Inc will not be liable to warrant failures of warranted parts caused by the use of a non-exempted add-on or modified part.

WARRANTED PARTS:

The repair or replacement of any warranted part otherwise eligible for warranty coverage may be excluded from such warranty coverage if MTD Consumer Group Inc demonstrates that the outdoor equipment engine has been abused, neglected, or improperly maintained, and that such abuse, neglect, or improper maintenance was the direct cause of the need for repair or replacement of the part. That notwithstanding, any adjustment of a component that has a factory installed, and properly operating, adjustment limiting device is still eligible for warranty coverage. Further, the coverage under this warranty extends only to parts that were present on the off-road engine and equipment purchased.

The following emission warranty parts are covered (if applicable):

1. Fuel Metering System
 - Cold start enrichment system (soft choke)
 - Carburetor and internal parts (or fuel injection system)
 - Fuel pump
 - Fuel tank
2. Air Induction System
 - Air cleaner
 - Intake manifold
3. Ignition System
 - Spark plug(s)
 - Magneto ignition system
4. Exhaust System
 - Catalytic converter
 - SAI (Reed valve)
5. Miscellaneous Items Used in Above System
 - Vacuum, temperature, position, time sensitive valves and switches
 - Connectors and assemblies
6. Evaporative Control
 - Fuel hose
 - Fuel hose clamps
 - Tethered fuel cap
 - Carbon canister
 - Vapor lines

CUB CADET LLC

MANUFACTURER'S LIMITED WARRANTY FOR

SERIES 2000 TRACTORS

IMPORTANT: To obtain warranty coverage owner must present an original proof of purchase and applicable maintenance records to the servicing dealer. Please see the operator's manual for information on required maintenance and service intervals.

The limited warranty set forth below is given by Cub Cadet LLC with respect to new merchandise purchased or leased and used in the United States and/or its territories and possessions, and by MTD Products Limited with respect to new merchandise purchased or leased and used in Canada and/or its territories and possessions (either entity respectively, "Cub Cadet").

Cub Cadet warrants this product (excluding its *Normal Wear Parts, Batteries, Frame, Front Axle* and Drive Shaft and *Attachments* as described below) against defects in material and workmanship for a period of four (4) years or three hundred (300) operation hours, whichever comes first, commencing on the date of original retail purchase or lease and will, at its option, repair or replace, free of charge, any part found to be defective in materials or workmanship.

Normal Wear Parts are warranted to be free from defects in material and workmanship for a period of thirty (30) days from the date of original purchase or lease. Normal wear parts include, but are not limited to items such as: belts, blades, blade adapters, grass bags, rider deck wheels, seats, and tires.

Batteries have a one-year prorated limited warranty against defects in material and workmanship, with 100% replacement during the first three months. After three months, the battery replacement credit is based on the months remaining in the twelve (12) month period dating back to the original date of original sale or lease. Any replacement battery will be warranted only for the remainder of the original warranty period.

Frame, Front Axle and Drive Shaft — Cub Cadet warrants the frame, front cast iron pivot axle and drive shaft against defects in material and workmanship for a period of five (5) years or 500 hours, whichever occurs first, commencing on the date of original purchase or lease.

Attachments — Cub Cadet warrants attachments for this product against defects in material and workmanship for a period of two (2) years, commencing on the date of the attachment's original purchase or lease. Attachments include, but are not limited to items such as: grass collectors and mulch kits.

This limited warranty shall only apply if this product has been operated and maintained in accordance with the Operator's Manual furnished with the product, and has not been subject to misuse, abuse, neglect, accident, improper maintenance, alteration, vandalism, theft, fire, water, or damage because of other peril or natural disaster. Damage resulting from the installation or use of any part, accessory or attachment not approved by Cub Cadet for use with the product(s) covered by this manual will void your warranty as to any resulting damage. In addition, Cub Cadet may deny warranty coverage if the hour meter, or any part thereof, is altered, modified, disconnected or otherwise tampered with.

HOW TO OBTAIN SERVICE: Warranty service is available, WITH PROOF OF PURCHASE AND APPLICABLE MAINTENANCE RECORDS, through your local authorized service dealer. To locate the dealer in your area:

In the U.S.A.

Check your Yellow Pages, or contact Cub Cadet LLC at P.O. Box 361131, Cleveland, Ohio 44136-0019, call 1-877-282-8684 or log on to our website at www.cubcadet.com.

In Canada

Contact MTD Products Limited, Kitchener, ON N2G 4J1, call 1-800-668-1238 or log on to our website at www.mtdcanada.com.

Without limiting the foregoing, this limited warranty does **not** provide coverage in the following cases:

- a. Routine maintenance items such as lubricants, filters, blade sharpening, tune-ups, brake adjustments, clutch adjustments, deck adjustments, and normal deterioration of the exterior finish due to use or exposure.
- b. Service completed by someone other than an authorized service dealer.
- c. Cub Cadet does not extend any warranty for products sold or exported outside of the United States and/or Canada, and their respective possessions and territories, except those sold through Cub Cadet's authorized channels of export distribution.
- d. Replacement parts and/or accessories that are not genuine Cub Cadet parts.
- e. Transportation charges and service calls.

There are no implied warranties, including without limitation any implied warranty of merchantability or fitness for a particular purpose. No warranties shall apply after the applicable period of express written warranty above. No other express warranties beyond those mentioned above, given by any person or entity, including a dealer or retailer, with respect to any product, shall bind Cub Cadet. The exclusive remedy is repair or replacement of the product as set forth above. The terms of this warranty provide the sole and exclusive remedy arising from the sale and/or lease of the products covered hereby. Cub Cadet shall not be liable for any incidental or consequential loss or damage including, without limitation, expenses incurred for substitute or replacement lawn care services or for rental expenses to temporarily replace a warranted product.

Some jurisdictions do not allow the exclusion or limitation of incidental or consequential damages, or limitations on how long an implied warranty lasts, so the above exclusions or limitations may not apply to you.

In no event shall recovery of any kind be greater than the amount of the purchase price of the product sold. **Alteration of safety features of the product shall void this warranty.** You assume the risk and liability for loss, damage, or injury to you and your property and/or to others and their property arising out of the misuse or inability to use the product.

This limited warranty shall not extend to anyone other than the original purchaser or to the person for whom it was purchased as a gift.

HOW LOCAL LAWS RELATE TO THIS WARRANTY: This limited warranty gives you specific legal rights, and you may also have other rights that vary in different jurisdictions.

Cub Cadet LLC, P.O. BOX 361131 CLEVELAND, OHIO 44136-0019, Phone: 1-877-282-8684
MTD Products Limited, Kitchener, ON N2G 4J1, Phone: 1-800-668-1238