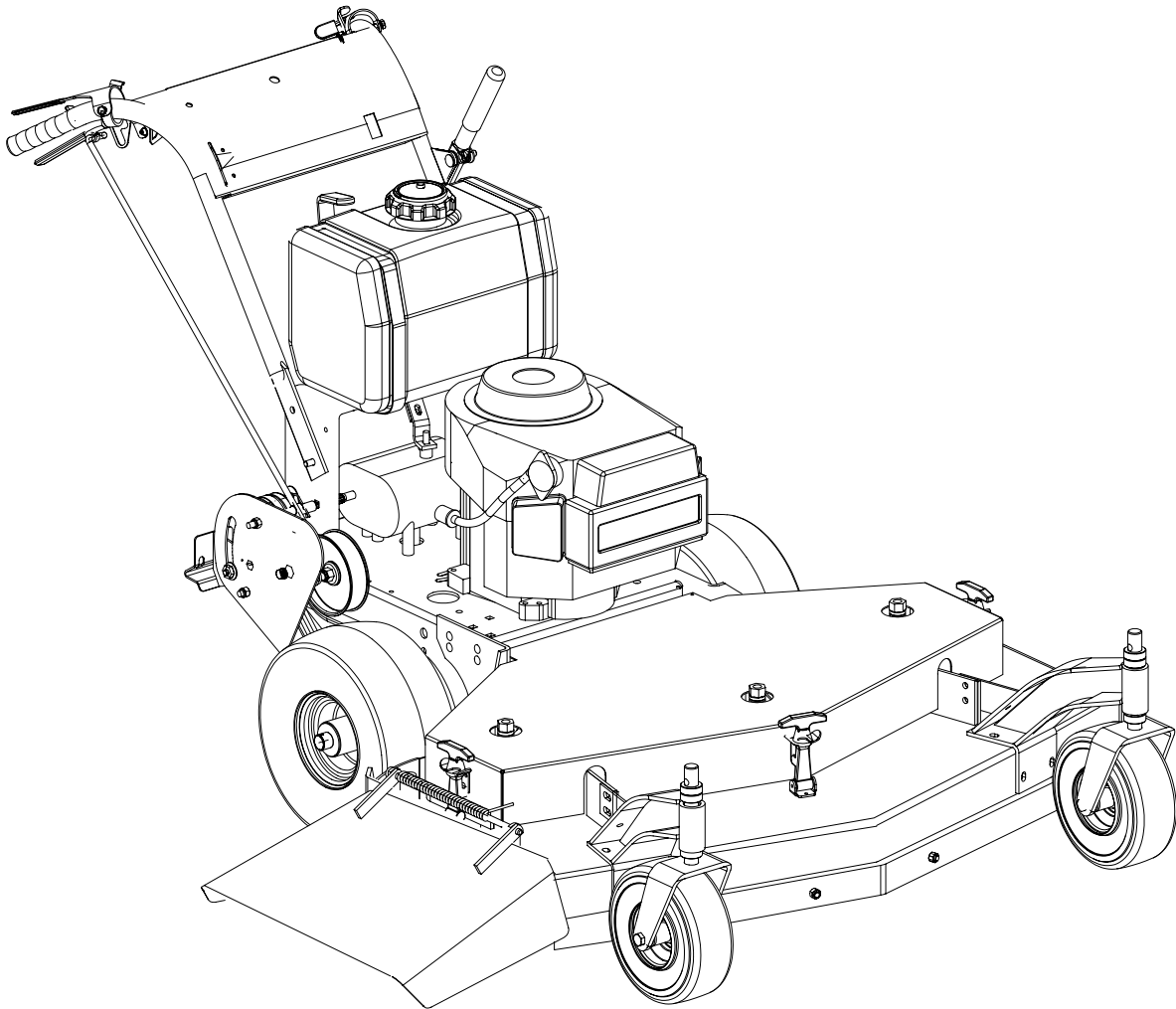




**G1332, G1336, G1548**  
**Walk-Behind Commercial**  
**Rotary Mowers**  
*Professional Turf Equipment*



**OPERATOR'S AND SERVICE MANUAL**

---

# INDEX

---

Foreword.....	3
Safety Precautions.....	4
A. General .....	4
B. Related to Fuel .....	4
C. When Mowing.....	4
Safety Decals .....	5-6
Specifications .....	7
Operating Instructions.....	7-9
A. Controls.....	7
1.Ignition Switch.....	7
2.Fuel Shutoff Valve .....	7
3.Engine Throttle .....	7
4.Recoil Starter .....	7
5.Transmission Shift Lever.....	7
6.Blade Clutch.....	8
7.Steering/Brake Lever .....	8
8.Neutral Latch Levers.....	8
9.Operator Presence Levers.....	8
B.Initial Adjustments.....	8
C.Break-In and Operation.....	8-9
Cutting Height Adjustment Table.....	10
Maintenance .....	10-14
A.General Maintenance .....	10
B.Daily Maintenance After Mowing.....	10
C.Maintenance Every 40 Hours.....	10
D.Lubrication Chart.....	11
E.Engine Maintenance .....	11
F.Mower Maintenance .....	11
1.To Change a Blade.....	11
2.To Sharpen a Blade.....	11
3.To Change the Blade Drive Belts .....	11
4.To Change the Transmission Drive Belt.....	12
5.To Change Either Traction Drive Belt.....	12
6.To Change a Spindle Assembly.....	13
7.To Adjust the Lite Touch (Manually).....	13
Suggested Replacement Parts - Mower.....	14
Suggested Replacement Parts - Engine .....	14
Warranty.....	BC

# FOREWORD

---

The Cub Cadet Commercial, Walk-Behind, Rotary Mowers have been developed for use by professional landscapers, commercial lawn service companies, professional turf managers and golf course superintendents. The machines incorporate many safety features that should be studied by all operators and maintenance personnel before use. The list of safety precautions should receive particular attention. This manual presents the operating and maintenance instructions necessary to keep your Cub Cadet Commercial mower at peak efficiency. If properly operated and maintained, your Cub Cadet Commercial mower will give dependable and trouble-free service.

Although hazard control and accident prevention partially are dependent upon the design and configuration of the equipment, these factors are also dependent upon the awareness, concern, prudence, and proper training of the personnel involved in the operation, transport, maintenance and storage of the equipment.



**CAUTION:** THE Cub Cadet Commercial, Walk-Behind, Rotary Mowers should only be operated and maintained by thoroughly trained individuals. The machines could cause serious injury to anyone who misuses them or does not understand their operation. All operators and maintenance personnel are urged to read this entire manual for their personal safety.



**WARNING:** The Engine Exhaust from this product contains chemicals known to the State of California to cause cancer, birth defects or other reproductive harm.

**NOTE:** The engine manufacturer is responsible for all engine-related issues with regards to performance, power-rating, specifications, warranty and service. Please refer to the engine manufacturer's owner's/operator's manual, packed separately with your unit, for more information.

This product may be covered by one or more of the following patents:  
D415,503; 5,928,097; 6,012,274; 5,355,665; 6,226,966; 6,266,949

# SAFETY PRECAUTIONS

---

## A. General:

1. Read this Operator's Manual completely before starting the mower. Study the controls and learn the proper sequence of operation. Retain Operator's Manual in a safe place for future reference.
2. Do not allow anyone to operate or maintain this machine who has not read the manual. **Never permit children under the age of 16 to operate this machine.**
3. Always have your feet and hands clear of the cutter deck when starting the engine.
4. Do not remove any shields, guards, decals or safety devices. If a shield, guard, decal or safety device is damaged or does not function, repair or replace it before operating the mower.
5. Always wear safety glasses, long pants and safety shoes when operating or maintaining this mower. Do not wear loose-fitting clothing.
6. Never run the engine indoors without adequate ventilation. Exhaust fumes are deadly.
7. To avoid serious burns, do not touch the engine or muffler while the engine is running or until it has cooled for at least 30 minutes after it has been shut off.
8. Do not allow anyone to ride on this mower. No passengers.
9. Do not operate this mower under the influence of alcohol and or drugs.
5. Watch for holes, sprinkler heads and other hidden hazards.
6. Reduce speed when making sharp turns.
7. Always have proper footing on slopes and hill sides and never operate when conditions are slippery.
8. Always keep both hands on the handles when mowing. Always walk, never run.
9. Never engage the blade clutch when the engine is running unless you are on grass that you intend to mow.
10. Be careful when crossing gravel paths or road- ways. Always disengage the blade clutch and wait until the blades stop rotating.
11. Never leave the mower unattended without disengaging the blade clutch, shifting the transmission into neutral, placing the neutral latch levers in the neutral lock position, shutting off the engine, removing the key from the ignition switch and closing the fuel shutoff valve.
12. Always park the mower and start the engine on a level surface with the transmission in neutral, the blade clutch disengaged and the neutral latch levers in the neutral lock position.
13. Shut off the engine and wait for the blades to stop rotating before removing the grass catcher.
14. If you hit a solid object while mowing, disengage the blade clutch, shift the transmission into neutral, place the neutral latch levers in the neutral lock position and stop the engine. Disconnect the spark plug wire(s) and inspect for damage. Repair any damage and make sure the blades are in good condition and the blade bolts are tight before restarting the engine.

## B. Related To Fuel:

1. Gasoline is highly flammable. Respect it.
2. Do not smoke or permit others to smoke while handling gasoline.
3. Always use approved containers for gasoline.
4. Always shut off the engine and permit it to cool before removing the cap of the fuel tank.
5. If the fuel container spout will not fit inside the fuel tank opening, use a funnel.
6. When filling the fuel tank, stop when the gasoline reaches one inch from the top. This space must be left for expansion. Do not overfill.
7. Wipe up any spilled gasoline.
15. Do not mow excessively steep slopes (No more than 17 degrees or a 30% grade). Mow across the slope, not up and down the slope.
16. Never raise the mower deck while the blades are rotating.
17. Never walk or stand on the discharge side of a mower with the engine running. Disengage the blade clutch if another person approaches while you are operating a mower.

## C. When Mowing:



**WARNING: Never mow in fourth gear (transport speed).**

1. Keep adults, children and pets away from the area to be mowed.
2. Never use this mower without the discharge chute installed and set in the down position.
3. Mow only in daylight or proper artificial light.
4. Always remove debris and other objects from the area to be mowed.
18. Always disconnect the spark plug wire and negative battery cable to prevent the engine from accidentally starting before performing any maintenance on this mower.
19. Keep the mower and especially the engine clean and free of grease, grass and leaves to reduce the chance of fire and to permit proper cooling.
20. The operator presence control levers located at each handle are designed for your safety. Do not try to defeat their operation. If the blade clutch is engaged or the transmission is in gear, releasing both handles will shut off the mower's engine.

# SAFETY DECALS


---

Keep safety decals clean. Replace any safety decal that is damaged, destroyed, missing, painted over or can no longer be read. Replacement safety decals are available through your dealer. (Left and right sides are determined standing behind the unit in the operating position.)

**WARNING**

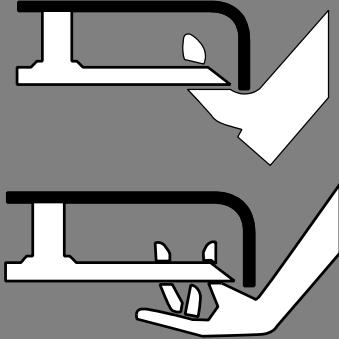
**OPEN BELT DRIVE**


**STOP ENGINE BEFORE REACHING UNDERNEATH**

 **WARNING**

- TURN OFF ENGINE AND ALLOW TO COOL BEFORE REFUELING.
- DO NOT SMOKE NEAR FUEL.

<p>CLOSE FUEL VALVE WHEN MACHINE IS NOT IN USE</p>	<p>IF VALVE IS LEFT OPEN, SEVERE ENGINE DAMAGE OR HARD STARTING MAY RESULT FROM FLOODING</p>
--	--



 **DANGER**

**ROTATING BLADE**  
Do not put hands or feet under or into mower when engine is running.

 **WARNING**

**SHIELD MISSING**

**DO NOT OPERATE**

## ! DANGER

### To Avoid Injury:

- Always connect the “ground” (Black) cable last and remove it first whenever performing any battery maintenance.
- Do not contact battery terminals or tools used to loosen the terminals with metal parts.
- Avoid contact with battery acid.
- Keep sparks and flames away from the battery.

## ! CAUTION

Serious bodily injury may result from failure to follow safe operating procedures.

1. Read the Operators Manual before operating this machine.
2. Clear area of debris before mowing.
3. Do not remove or disable any shield, guard or safety device.
4. Always chock the wheels when parking the machine on a slope.
5. Stop engine, disconnect the spark plug and disengage blade drive before adjusting or servicing.
6. Keep people and pets a safe distance away from machine.
7. Do not add fuel while engine is warm or running.
8. Use caution on slopes.
9. Before leaving the operators position:
  - Disengage the cutter blades.
  - Shift transmission to neutral and engage neutral locks.
  - Wait for all movement to stop.



# SPECIFICATIONS

## POWER UNIT

Engine:	13 or 15 HP Kawasaki.
Type:	4-cycle, single-cylinder, recoil start.
Air Cleaner:	Dual element, dry-type.
Lube System:	Pressurized.
Fuel Tank:	5 gallons, polyethylene.
Transmission:	5 speeds forward and 1 speed reverse.
Traction Drive:	Double V-belts.
Ground Speed:	2 to 4.5 MPH maximum.
Drive Wheels:	13 x 6.50-6 pneumatic tires mounted on steel wheels with ball bearings.
Brakes:	Two 6-inch drum, external band type.
Controls:	Right and left steering/brake levers; over-center blade clutch; transmission shift lever; engine throttle; cutter blade, transmission neutral and operator presence safety group; key-type ignition switch.
Frame	Steel Plate. All welded construction.
Handles	1-1/4" diameter, tubular steel, adjustable.

## CUTTING DECK

Cutting Width:	32"	36"	48"	52"
Overall Width:	33"	37"	49"	53"
Number of Blades:	2	2	3	3
Height of Cut:	2 to 4 inches in 1/4" increments.			
Deck Material:	10 gauge steel top with 7 gauge steel skirt.			
Casters	9 x 3.50-4, 4-ply tires with inner tubes. Wheels have open-cage roller bearings.			

# OPERATING INSTRUCTIONS

## A. Controls

### 1. Ignition Switch: (Recoil Start)

Located in the center of the control panel between the handles. When the key is inserted and turned clockwise 90 degrees, the engine can be started if the transmission shift lever is in neutral and the blade clutch is disengaged.

### (Electric Start)

Located in the center of the control panel between the handles. When the key is inserted and turned clockwise 90 degrees, the engine will start if the transmission shift lever is in neutral and the blade clutch is disengaged.

### 2. Fuel Shutoff Valve:

Located under the fuel tank in the opening of the handle mount frame. The handle turns 90 degrees. When the handle is in a horizontal position, it will shut off the flow of fuel to the engine. When it is turned to a vertical position, it will open and allow fuel to flow to the engine. Anytime the mower is being trailered or, if the mower will not be in use for 30 minutes or more, close the fuel shutoff valve to prevent flooding the engine.

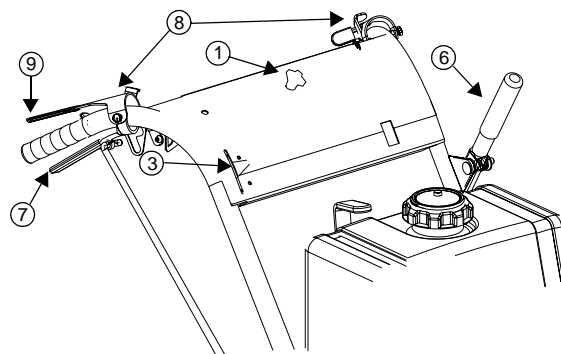
### 3. Engine Throttle:

Located on the right side of the control panel between the handles. Moving the throttle lever from the front to the rear will increase the engine speed from slow to fast. To start the engine, set the throttle all the way to the rear in the "Choke" position. After the engine starts, move the throttle halfway between slow and fast.

### 4. Recoil Starter:

Located on the top of the engine. To start the engine,

set the throttle on "Choke" and grasp the starter grip and pull slowly until the starter engages. Then pull the cord rapidly to overcome compression, prevent kickback and start the engine. Repeat if necessary with the throttle pushed halfway back to the "Slow" position.



**Figure 1 The Control Panel**

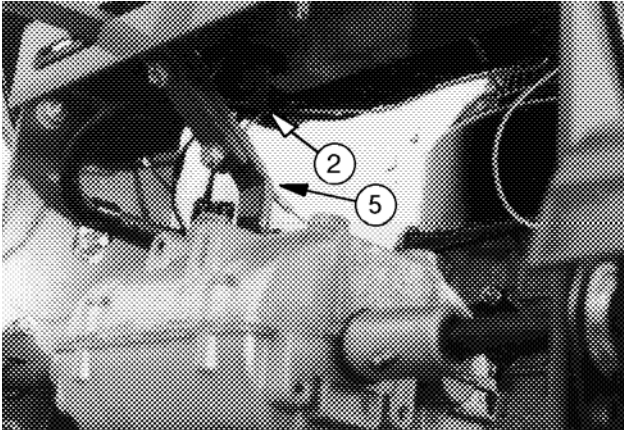
- 1. Ignition Switch
- 2. Fuel Shutoff Valve
- 3. Engine Throttle
- 4. Blade Clutch Lever or Electric Blade Clutch
- 5. Transmission Shift Lever
- 6. Blade Clutch Lever or Electric Blade Clutch
- 7. Right Steering Brake Lever
- 8. Neutral Latch Levers
- 9. Right Operator Presence Lever

### 5. Transmission Shift Lever:

Located under the control panel. The lever has seven positions moving from the left to the right:

Reverse Gear, Neutral, First Gear, Second Gear, Third Gear, Fourth Gear and Fifth Gear. The lever must be in the Neutral position in order to start the engine. Never attempt to mow in Fifth Gear. Fifth Gear should be used for transport only. **Note: DO NOT shift the transmission from one forward gear to another while moving.**

# OPERATING INSTRUCTIONS



**Figure 2 View Looking Under The Fuel Tank**

2. Fuel Shutoff Valve      5. Transmission Shift Lever

## 6. Blade Clutch (Manual and Electric):

Located on the left handle below the control panel. This is an over-center belt clutch. When the handle is pushed forward it snaps to rest and forces the idler pulley into the blade drive belt causing the blades to rotate. Pull back the handle and the pressure on the belt is relieved and the blades stop rotating. **Electric:** Located on the left side of the control panel, this is an on/off toggle switch that controls the electric blade clutch which supplies power to the cutting blades. See Handle Assembly with Electric Blade Clutch in Parts List.

## 7. Steering Brake Levers:

There is a right-hand lever located beneath the outer end of the right handle and a left-hand lever located beneath the outer end of the left handle. Each lever operates independently and when squeezed against spring tension, lifts the idler pulley from applying pressure to the traction drive belt on the right or left side and applies the right or left side brake. When the levers are released, the mower will move ahead in a straight line if the engine is running and the transmission is engaged in a forward gear. Steering is accomplished by squeezing the steering/brake lever on the side to which the turn is to be made.

## 8. Neutral Latch Levers:

Pivoted inside each handle there is a neutral latch lever which works with each of the steering/brake levers. When either of the steering/brake levers is squeezed and its neutral latch lever pushed forward and engaged in the neutral lock position, the steering/brake lever is held in a position where the idler pulley is not applying pressure to the traction drive belt and the brake is not quite engaged. The neutral latch levers should be engaged in the neutral lock position before starting the engine.

## 9. Operator Presence Levers:

Located above the outer ends of the right and left handles, these levers must be held down on the handles against spring pressure in order to shift the transmission shift lever into gear or engage the blade clutch.

Releasing the operator presence levers with either the transmission shift lever in gear or the blade clutch engaged will shut off the engine.

## B. Initial Adjustments

1. Disconnect the spark plug wire.
2. Check the tire pressure. Drive Wheels should be inflated to 25 psi. Caster Wheels should be inflated to 15 psi. Note: New tires are overinflated in order to properly seat the bead to the rim.
3. Check that all nuts, bolts and screws are tight.
4. Check the tension of the deck drive belts:
  - a. Remove the deck cover shield and engage the blade clutch.
  - b. Make sure the belts clear the belt guides by 1/8" to 1/4".
  - c. The tension of the deck drive belts should be adjusted so that a ten-pound pull between two pulleys deflects each belt about 1/2". Do not overtighten these belts. The blade clutch should engage with only moderate force.
  - d. Replace the deck cover shield and disengage the blade clutch.
5. The tension of the transmission drive belt should be adjusted so that a five-pound pull between the engine traction drive pulley and the transmission drive pulley deflects the belt about 3/16".
6. The two drive wheel belts are self-adjusting.
7. The steering control rods on each side of the handle assembly should initially be adjusted so that there is about a 1/4" space between the rod and the bottom of the slot in the neutral latch lever with the latch in the drive position. To make this adjustment, remove the large hairpin from the swivel joint at the bottom of each steering control rod and thread the swivel joint up or down the rod as needed.
8. The brake rods (above each drive wheel) should be adjusted so that when the steering/brake levers are squeezed and the mower is pulled backward, the brakes lock the drive wheels. The machine should roll freely when the neutral latch lever is in the neutral lock position. To adjust the brake rods, remove the large hairpin from the swivel joint at the top of each brake rod and thread the swivel joint up or down the rod as needed.
9. Adjusting the cutting height: The mower is shipped with the cutting height set at 3 inches  $\pm$ 1/4 inch depending on the air pressure in the tires. To change the cutting height, blade spacers and/or caster spacers must be moved according to the table on page 6.
10. Lubricate all fittings listed in the maintenance section.


## C. Break-In and Operation:

1. Make certain you thoroughly understand all of the safety precautions before you attempt to operate this machine.
2. Check the engine oil level. Fill to the proper level with 10W-40 engine oil rated for service SE or SF.



# OPERATING INSTRUCTIONS

---

3. Move the mower outdoors. Check the engine gasoline level. When filling the tank, stop when the gasoline reaches one inch from the top. This space must be left for expansion. Use fresh, clean, unleaded, regular gasoline.
  4. Move the mower to a "test area" where you can operate the mower for about half an hour without being disturbed.
  5. To start the engine:
    - a. Shift the transmission to neutral.
    - b. Disengage the blade clutch.
    - c. Place the neutral latch levers in the neutral lock position.
    - d. Connect the spark plug wire.
    - e. Open the fuel shutoff valve.
    - f. Move the throttle lever to the "Choke" position.
    - g. Put the key in the ignition switch and turn the switch on. (For electric-start engines: Turn the key to "Start". Do not hold the key in the start position for more than 10 seconds or you may damage the starter.)
    - h. For recoil-start engines: Grasp the starter grip and pull slowly until the starter engages and then pull the cord rapidly to overcome compression, prevent kickback and start the engine. Allow the cord to recoil slowly. Repeat if necessary.
    - i. Set the throttle at 50% of full engine RPM and allow the engine to warm up. Then, adjust the throttle to full engine RPM.
  6. After the engine has warmed up, shut off the ignition and check the operation of the safety switches. Make certain that the engine will not start unless the ignition switch is turned on, the transmission is in neutral and the blade clutch is disengaged. If the engine will start with the transmission in any gear other than neutral, immediately shut off the engine and replace the neutral safety switch on top of the transmission. If the engine will start with the blade clutch engaged, immediately shut off the engine and adjust or replace, if necessary, the blade safety switch mounted on the engine deck. Start the engine and hold the left operator presence control lever down against the left handle and move the transmission shift lever into first gear. Now take your hand off the operator presence control lever and the engine should die. If it does not, immediately shut off the engine and adjust or replace, if necessary, the operator presence switch under the control panel. Shift the transmission into neutral, restart the engine, hold the left operator presence control down against the left handle and engage the blade clutch. Now take your hand off of the operator presence lever and the engine should die. If it does not, immediately shut off the engine and adjust or replace, if necessary, the operator presence switch under the control panel. Disengage the blade clutch.
  7. Restart the engine.
  8. Push the blade clutch lever forward until it engages and the cutter blades start rotating.
  9. Shift the transmission into first gear. (It is suggested that you practice mowing in first gear.)
  10. Squeeze both steering/brake levers with both hands and release the neutral latch levers from the neutral lock position.
  11. Slowly release the steering/brake levers and the mower will move ahead in a straight line. To turn the mower, squeeze the steering/brake lever on the side to which you want to turn.
  12. To stop the mower's forward motion, squeeze both steering/brake levers until the mower stops and place the neutral latch levers into the neutral lock position.
  13. Before shifting into reverse gear, the mower's forward motion must be completely stopped. For maximum traction in reverse, the steering/brake levers should be pushed downward.
- WARNING: To avoid possible bodily injury and to prevent damage to the transmission, the mower must be completely stopped before attempting to shift from forward to reverse or reverse to forward.**
- 
14. Practice operating the mower and as you gain confidence, shift the transmission from first to second and mow for a while and then shift from second to third. Mow for at least one-half hour and then return the mower to the shop.
  15. To stop and shut off the mower, squeeze both steering/brake levers and place the neutral latch levers into the neutral lock position, disengage the blade clutch, shift the transmission into neutral, turn off the ignition to stop the engine, close the fuel shutoff valve and disconnect the spark plug wire.
  16. Check that all nuts, bolts and screws are still tight.
  17. Check, and adjust if necessary, the tension of the deck drive belts and the transmission drive belt as described in items 4 and 5 of the Initial Adjustment section.
  18. Readjust the steering control rods and the brake rods. They may require frequent adjustment until the belts and brake bands have properly seated. These adjustments are described in items 7 and 8 of the Initial Adjustment section.
  19. After the first full day of mowing, all nuts, bolt and screws should be rechecked for proper tightness and the belts should be rechecked for proper tension.

# CUTTING HEIGHT ADJUSTMENT TABLE

Note: The front edge of the cutting deck should be 1/8" - 1/4" below the rear edge of the deck so that the blades are cutting grass in only the front half of their circular path. This decreases friction and reduces the drive power required.

Approximate Cutting Height	1/4" Blade Spacers Above and Below The Spindle Assemblies		1/2" Caster Spacers Above and Below The Caster Bracket		
	Inches	Above	Below	Above	
2	0	5	3	1	Engine Deck bolted to <b>upper</b> holes on cutting deck.
2-1/8	1	4	3	1	
2-3/8	2	3	3	1	
2-1/2	1	4	2	2	
2-3/4	2	3	2	2	
3	3	2	2	2	
3-1/4	4	1	2	2	
3-1/2	5	0	2	2	
2-3/4	0	5	2	2	Engine Deck bolted to <b>lower</b> holes on cutting deck.
3	1	4	2	2	
3-1/4	2	3	2	2	
3-1/2	3	2	2	2	
3-3/4	4	1	2	2	
3-1/4	0	5	1	3	
3-1/2	1	4	1	3	
3-3/4	2	3	1	3	
4	3	2	1	3	

## MAINTENANCE



**WARNING:** Disconnect the spark plug wire to prevent the engine from accidentally starting before performing any maintenance on this mower.

### A. GENERAL MAINTENANCE:

1. If the mower must be tipped on its side for maintenance, first drain the fuel from the fuel tank and the oil from the engine's crankcase.
2. Be careful not to spill lubricant on the drive belts.
3. Do not tamper with the engine's governor settings. They are adjusted to provide the proper maximum engine speed.
4. If the mower is to be in storage for more than 30 days, drain the fuel tank, run the engine to drain the carburetor dry, change the oil, remove the spark plug and pour a teaspoonful of oil into the cylinder. Pull the starter cord slowly to crank the engine and distribute the oil then replace the spark plug.

### B. DAILY MAINTENANCE AFTER MOWING:

1. Park the mower outside the storage facility with the engine shut off.
2. Close the fuel shutoff valve.
3. Permit the mower to cool.
4. Disconnect the spark plug wire.

5. Wash the mower off with water. Be sure to clean out grass clippings from under the cutter deck and also under the deck cover. Allow the mower to dry before storing.
6. Check that the blade mounting bolts are tight.
7. Check that the blades are sharp. NOTE: Never mow with dull blades.
8. Check the fuel level, the engine oil level and clean the cooling-air intake (the rotating screen).
9. Clean the air cleaner elements (foam and paper).
10. After the first 5 hours of use, change the engine oil. (Change the oil every 40 hours thereafter.)
11. Follow the lubrication chart on page 7.
12. Place the mower in locked storage to avoid tampering or use by an untrained operator.

### C. MAINTENANCE EVERY 40 HOURS:

1. Change the engine oil and replace the oil filter. (Change the engine oil more frequently under severe operating conditions.)
2. Check that all nuts, bolts and screws are tight.
3. Check the condition and tension of all belts.
4. Clean the spark plug and check the spark plug gap.
5. Follow the lubrication chart on page 7.
6. Check condition and operation of all safety switches.

# MAINTENANCE

## D. LUBRICATION CHART: See Figures 3, 4 & 5 for Item Location

	NUMBER OF GREASING POSITIONS		ITEM	DESCRIPTION
	32" & 36"	48" & 52"		
DAILY	2	3	A	Cutter Blade Spindle Bearings
EVERY 40 HOURS	2	2	B	Caster Wheel Bearing
	2	2	C	Caster Wheel Pivot Shafts
	1	2	D	Deck Idler Pulley Pivot Arms
	2	2	E	Drive Wheel Bearings
	2	2	F	Brake Lever Pivots
	1	1	G	Blade Clutch Bellcrank Pivot
	2	2	H	Transmission-Jackshaft Couplers

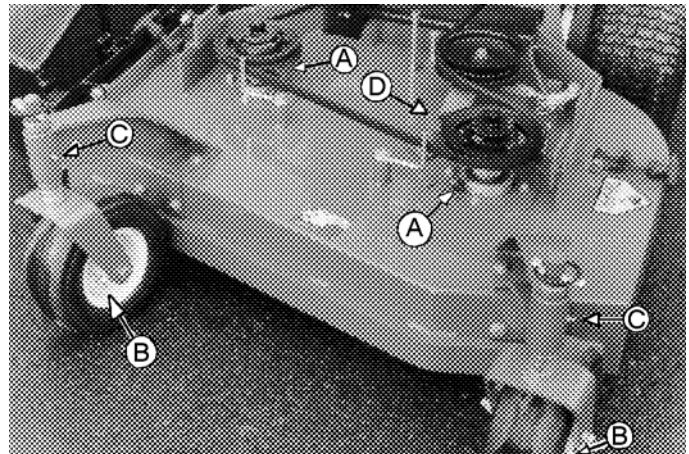


Figure 3

## E. ENGINE MAINTENANCE:

For detailed maintenance instructions for the engine on your mower, see the separate engine manual packed with your mower.

## F. MOWER MAINTENANCE:

### 1. TO CHANGE A BLADE: (See Figure 6.)

- a. Remove the deck cover.
- b. Tip the mower back and block up the front of the deck.
- c. Place one wrench on the hex head bolt under the blade. Use a second wrench to remove the locknut on top of the spindle pulley.
- d. Remember the number of blade spacers both above and below the spindle.
- e. Remove the long (9-1/2") blade bolt, the flat washer, the blade and the blade spacers.
- f. To replace the blade, reverse the above procedure. Be careful to replace the blade spacers correctly above and below the spindle.

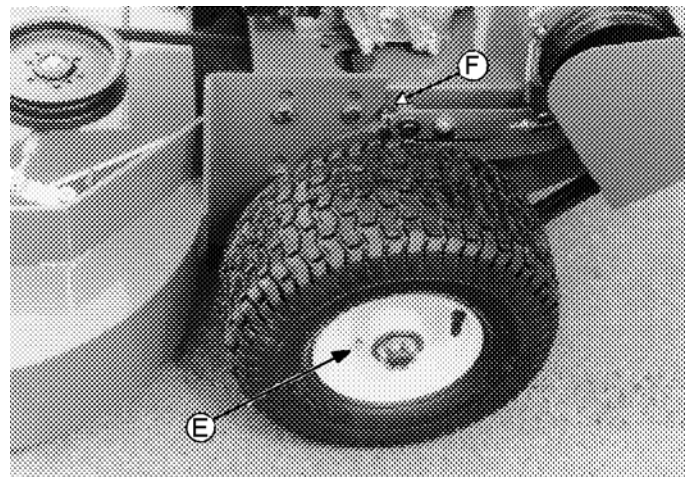


Figure 4

### 2. TO SHARPEN A BLADE:

- a. To sharpen a blade, clamp the blade in a vise and, using a flat mill file, carefully file the cutting surface on each end of the blade to a sharp edge.
- g. Blades with severe nicks or dents that cannot be removed by filing should be replaced.
- h. After sharpening, check the balance of the blade by placing the blade on a blade balancer fulcrum device.
- i. If the blade dips on one end, file stock off of the cutting surface on that end. NOTE: If a blade cannot be easily balanced, replace it.

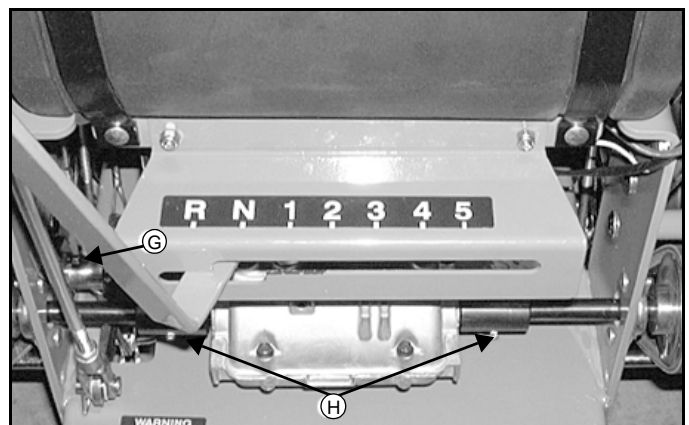
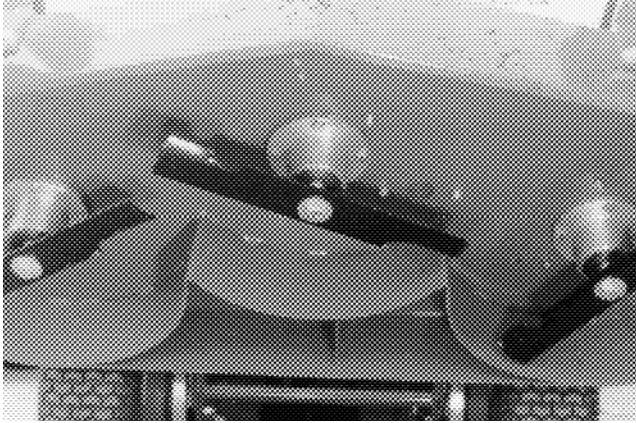


Figure 5

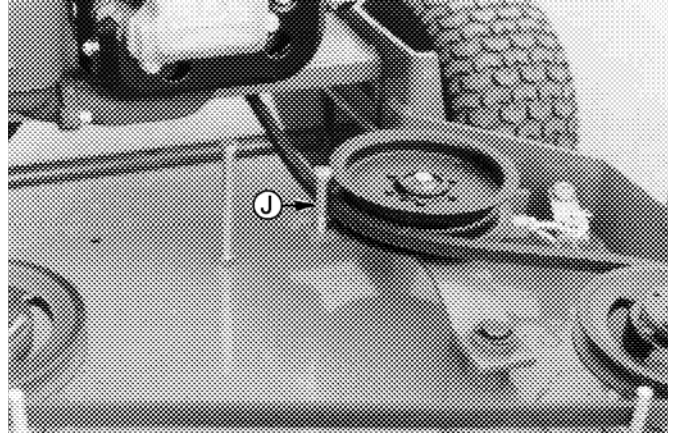
### 3. TO CHANGE THE DRIVE BELTS:

- a. Make sure the blade clutch is disengaged.
- b. Remove the deck cover.
- c. Remove the cap screw which serves as a belt guide and is mounted in the idler pulley arm. (Item J, Figure 7.)

# MAINTENANCE

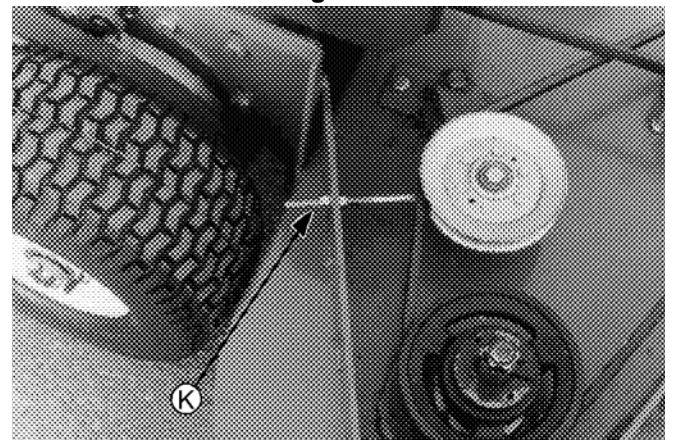


**Figure 6**



**Figure 7**

- d. Slip the long blade drive belt off of the pulleys.
- e. (48" ONLY) Loosen the idler pull rod which holds the idler pulley tight against the short blade drive belt. (Item K, Figure 8.)
- f. Remove the short blade drive belt from the pulleys.
- g. Place a new short blade drive belt back on the pulleys and tighten the idler pull rod to hold the idler pulley tight against the belt.
- h. Place a new long blade drive belt through the belt guide and loop it around the engine pulley and then around the two deck pulleys. The belt's back side should ride on the idler pulley.
- i. Replace the cap screw, lock washer and nut in the idler pulley arm.
- j. The idler pulleys should be adjusted so that when the blade clutch is engaged, a ten-pound pull between two pulleys deflects either belt about 1/2". Do not overtighten these belts. The blade clutch should engage with only moderate force.
- k. Replace the deck cover.

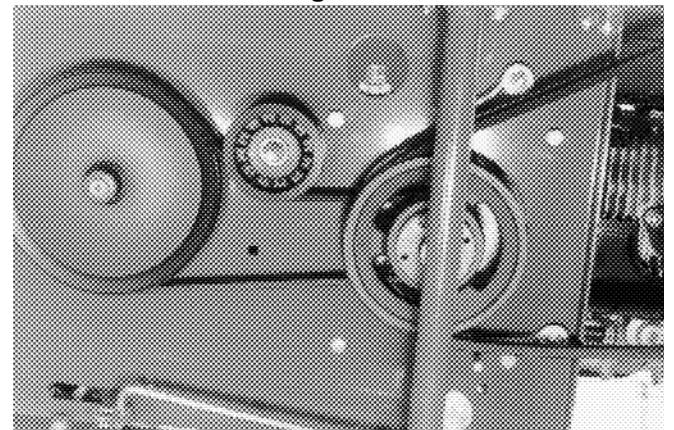


**Figure 8**

#### **4. TO CHANGE THE TRANSMISSION DRIVE BELT:**

(See Figure 9)

- a. Make sure the blade clutch is disengaged.
- b. Working under the engine deck, take the long blade drive belt off of the engine pulley.
- c. Loosen the locknut holding the transmission drive belt idler pulley in place and slide the pulley away from the transmission drive belt.
- d. Remove the old belt and mount a new belt on the pulleys.
- e. Slide the idler pulley back onto the belt and tighten the locknut holding it in place. The idler pulley should be adjusted so that a five-pound pull on the belt between the engine pulley and the transmission pulley deflects the belt about 3/16".
- f. Replace the long blade drive belt on the engine pulley.

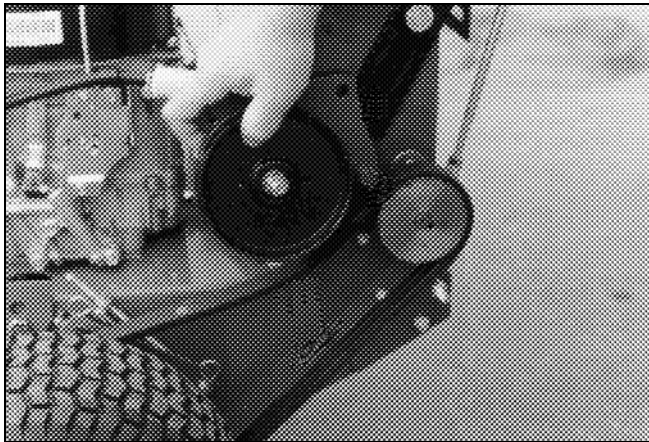


**Figure 9**

#### **5. TO CHANGE EITHER TRACTION DRIVE BELT:**

- a. Remove the hex nuts which hold the belt guard in place. Remove the belt guard.
- b. Place the neutral latch lever in the neutral lock position.
- c. Remove the hairpin cotters from the two swivel joints which are inserted through the idler bracket and remove the swivel joints from the idler bracket.

# MAINTENANCE



**Figure 10**

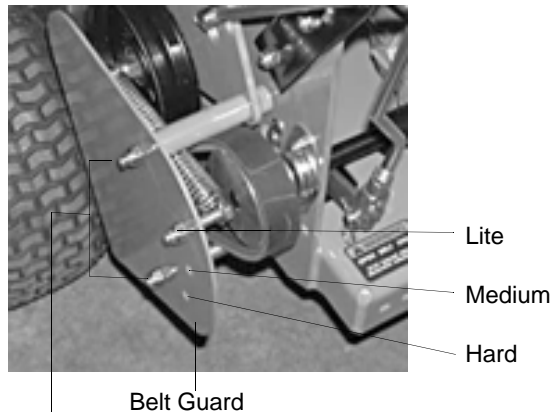
- d. Lift up on the idler bracket with one hand while removing the belt from the jackshaft pulley with the other hand. (See Figure 10.)
- e. Prop up the side of the mower and slip the belt over the drive wheel.
- f. Slip the new traction drive belt over the drive wheel and loop it over the jackshaft pulley while lifting up on the idler bracket.
- g. Insert the swivel joints in the holes in the idler bracket and replace the hairpin cotters.
- h. Replace the belt guard and the two nuts.

## 6. TO CHANGE A SPINDLE ASSEMBLY:

- a. Make sure the blade clutch is disengaged.
- b. Remove the deck cover.
- c. Remove the blade. (See paragraph 1. To Change a Blade.)
- d. Remove the blade drive belts. (See paragraph 3. To Change the Blade Drive Belts.)
- e. Remove the two bolts which hold the pulley bushing tight in the spindle pulley and thread the bolts into the other two holes in the bushing.
- f. Alternately turn each bolt 1/2 turn clockwise until the bolts force the pulley off of the bushing.
- g. Remove the bushing by tapping a large screw driver into the slot in the side of the bushing.
- h. Remove the key and the pulley.
- i. Tip the mower back and block up the front of the deck.
- j. Remove the four bolts and locknuts holding the spindle assembly to the deck.
- k. Remove the spindle assembly.

## 7. TO ADJUST THE LITE-TOUCH (MANUALLY)

- a. Three holes in the belt guard allow you to reposition the hex cap screw to adjust the brake lever. The top hole (lite tension), the middle hole (medium tension) and the lower hole (hard tension). The unit is shipped with the hex screw in the top hole. SEE THE FIGURE BELOW FOR REFERENCE. To adjust the bolt do the following:
- b. With a spring puller, pull the spring and detach it from the hex cap screw.
- c. Remove the lock nut from the lite touch hole in the belt guard.
- d. Loosen (but do not remove) the remaining two nuts on the belt guard.
- e. Pull the belt guard away from the unit. This will give clearance to remove the bolt. Note: If you are having difficulty removing the bolt, continue to loosen the two nuts on the belt guard (BUT DO NOT REMOVE). Remove the bolt and nut.
- f. Reposition the bolt and nut into the middle or lower hole and retighten all three nuts.
- g. Using a spring puller, reattach the spring to the hex cap screw.



Loosen remaining two nuts (**DO NOT REMOVE**)

**Figure 11**

# MAINTENANCE

---

## SUGGESTED MOWER REPLACEMENT PARTS

PART #	Description	32"	36"	48"
00021871	Rotary Blade, 16-1/2"	2		3
00050125	Rotary Blade, 18"		2	
01007591	Blade Bolt	2	2	3
00011807	Blade Nut	2	2	3
00021924	Blade Spacer	10	10	15
01007578	Drive Belt	1		
00050441	Drive Belt		1	
00021947	Long Drive Belt			1
00050480	Short Drive Belt			1
01000194	Transmission Drive Belt	1	1	1
01000151	Traction Drive Belt	2	2	2

## SUGGESTED ENGINE REPLACEMENT PARTS

Engine	Oil Filter	Air Filter	Air Filter Foam Wrap	Spark Plug
01007290 Kawasaki, 13.0 HP	KM-49065-2078	KM-11013-7017	KM-11013-7016	KM-92070-7003
01009794 Kaw. Kai., 13.0 HP	KM-49065-2078	KM-11013-7031	KM-11013-7025	KM-92070-7003
01007291 Kawasaki, 15.0 HP	KM-49065-2078	KM-11013-7017	KM-11013-7016	KM-92070-7003
01009795 Kaw. Kai., 15.0 HP	KM-49065-2078	KM-11013-7031	KM-11013-7025	KM-92070-7003

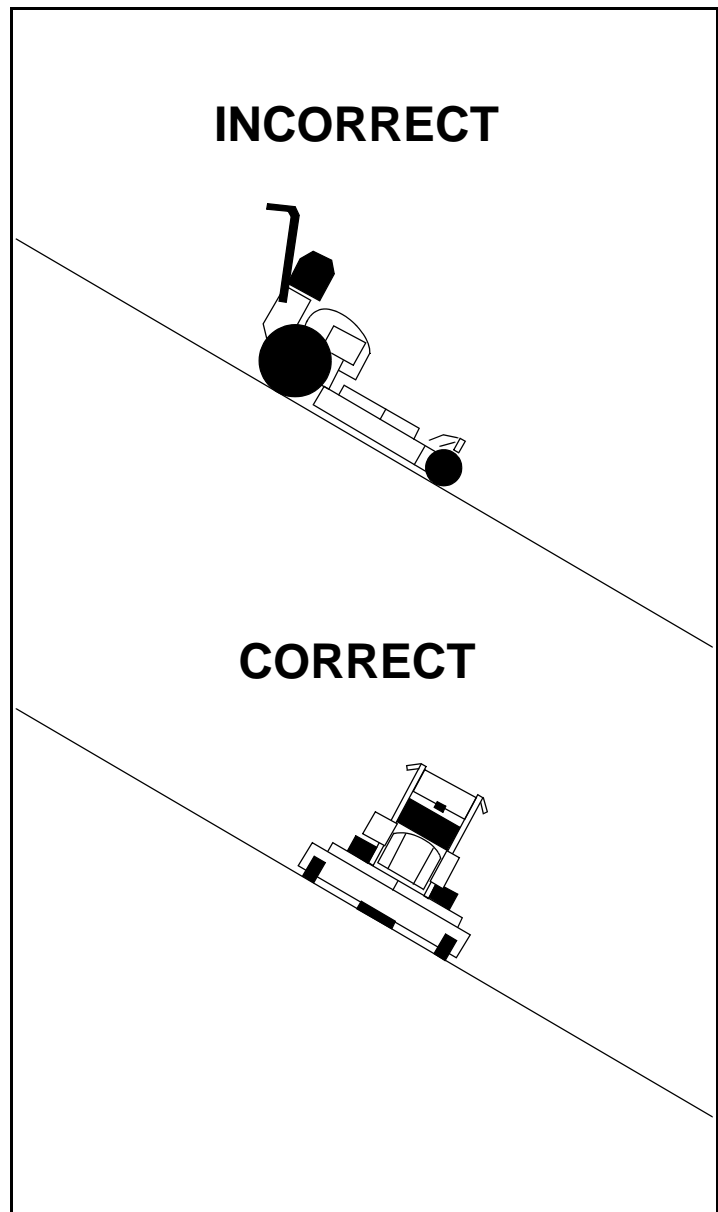
---

# Supplement Parking Instructions

## All Gear Walk-Behind Mowers

### Instructions

1. When parking mower on a hill, position mower perpendicular to the slope. **DO NOT PARK MOWER FACING DOWN SLOPE.**
2. Turn off the engine.
3. Place the Transmission Shift Lever in First Gear.
4. Disengage the Neutral Latch Levers.
5. Place chocks on both sides of the traction drive wheels. Alternate the chocks by placing one chock on the rear side of the wheel and another chock on the front side of the opposite wheel.











**CALIFORNIA EMISSION CONTROL WARRANTY STATEMENT  
YOUR WARRANTY RIGHTS AND OBLIGATIONS**

The California Air Resources Board and MTD Consumer Group Inc are pleased to explain the evaporative emission control system warranty on your 2006 lawn mower. In California, new lawn mower must be designed, built and equipped to meet the State's stringent anti-smog standards. MTD Consumer Group Inc must warrant the EECS on your lawn mower for the period of time listed below provided there has been no abuse, neglect or improper maintenance of your lawn mower.

Your EECS may include parts such as the carburetor, fuel-injection system, the ignition system, catalytic converter, fuel tanks, fuel lines, fuel caps, valves, canisters, filters, vapor hoses, clamps, connectors, and other associated emission-related components.

**Where a warrantable condition exists, MTD Consumer Group Inc will repair your lawn mower at no cost to you including diagnosis, parts and labor.**

**MANUFACTURER'S WARRANTY COVERAGE:**

This evaporative emission control system is warranted for two years. If any evaporative emission-related part on your equipment is defective, the part will be repaired or replaced by MTD Consumer Group Inc.

**OWNER'S WARRANTY RESPONSIBILITIES:**

As the lawn mower owner, you are responsible for performance of the required maintenance listed in your owner's manual. MTD Consumer Group Inc recommends that you retain all receipts covering maintenance on your lawn mower, but MTD Consumer Group Inc cannot deny warranty solely for the lack of receipts.

As the lawn mower owner, you should however be aware that MTD Consumer Group Inc may deny you warranty coverage if your lawn mower or a part has failed due to abuse, neglect, or improper maintenance or unapproved modifications.

You are responsible for presenting your lawn mower to MTD Consumer Group Inc's distribution center or service center as soon as the problem exists. The warranty repairs should be completed in a reasonable amount of time, not to exceed 30 days. If you have a question regarding your warranty coverage, you should contact the MTD Consumer Group Inc Service Department at 1-800-800-7310.

**GENERAL EMISSIONS WARRANTY COVERAGE:**

MTD Consumer Group Inc warrants to the ultimate purchaser and each subsequent purchaser that the lawn mower is: Designed, built and equipped so as to conform with all applicable regulations; and free from defects in materials and workmanship that cause the failure of a warranted part to be identical in all material respects to that part as described in MTD Consumer Group Inc's application for certification.

The warranty period begins on the date the lawn mower is delivered to an ultimate purchaser or first placed into service. The warranty period is two years.

Subject to certain conditions and exclusions as stated below, the warranty on emission-related parts is as follows:

1. Any warranted part that is not scheduled for replacement as required maintenance in the written instructions supplied, is warranted for the warranty period stated above. If the part fails during the period of warranty coverage, the part will be repaired or replaced by MTD Consumer Group Inc according to subsection (4) below. Any such part repaired or replaced under warranty will be warranted for the remainder of the period.
2. Any warranted part that is scheduled only for regular inspection in the written instructions supplied is warranted for the warranty period stated above. Any such part repaired or replaced under warranty will be warranted for the remaining warranty period.
3. Any warranted part that is scheduled for replacement as required maintenance in the written instructions supplied is warranted for the period of time before the first scheduled replacement date for that part. If the part fails before the first scheduled replacement, the part will be repaired or replaced by MTD Consumer Group Inc according to subsection (4) below. Any such part repaired or replaced under warranty will be warranted for the remainder of the period prior to the first scheduled replacement point for the part.
4. Repair or replacement of any warranted part under the warranty provisions herein must be performed at a warranty station at no charge to the owner.
5. Notwithstanding the provisions herein, warranty services or repairs will be provided at all of our distribution centers that are franchised to service the subject engines or equipment.
6. The lawn mower owner will not be charged for diagnostic labor that is directly associated with diagnosis of a defective, emission-related warranted part, provided that such diagnostic work is performed at a warranty station.
7. MTD Consumer Group Inc is liable for damages to other engine or equipment components proximately caused by a failure under warranty of any warranted part.
8. Throughout the lawn mower warranty period stated above, MTD Consumer Group Inc will maintain a supply of warranted parts sufficient to meet the expected demand for such parts.
9. Any replacement part may be used in the performance of any warranty maintenance or repairs and must be provided without charge to the owner. Such use will not reduce the warranty obligations of MTD Consumer Group Inc.
10. Add-on or modified parts that are not exempted by the Air Resources Board may not be used. The use of any non-exempted add-on or modified parts by the ultimate purchaser will be grounds for disallowing a warranty claims. MTD Consumer Group Inc will not be liable to warrant failures of warranted parts caused by the use of a non-exempted add-on or modified part.

**WARRANTED PARTS:**

The repair or replacement of any warranted part otherwise eligible for warranty coverage may be excluded from such warranty coverage if MTD Consumer Group Inc demonstrates that the lawn mower has been abused, neglected, or improperly maintained, and that such abuse, neglect, or improper maintenance was the direct cause of the need for repair or replacement of the part. That notwithstanding, any adjustment of a component that has a factory installed, and properly operating, adjustment limiting device is still eligible for warranty coverage. The following emission warranty parts list are covered: Fuel Line, Fuel Line Clamps



## MANUFACTURER'S LIMITED WARRANTY - TURF EQUIPMENT

This warranty is specific to the product manual to which it is attached.

For a complete list of products and warranties contact your authorized Cub Cadet Commercial dealer.

**Proper maintenance of the purchased Cub Cadet Commercial equipment is the owner's responsibility.** Follow the instructions in your owner's manual for correct lubricants and maintenance schedule. Your Cub Cadet Commercial dealer carries a complete line of quality lubricants and filters for your equipment's engine, transmission, chassis, and attachments.

**What is Covered By This Warranty?** This limited warranty covers any defect in materials and/or workmanship in your Cub Cadet Commercial equipment to the original owner for the following time periods:

- A) First (1<sup>st</sup>) Year of Original Ownership: **Both Parts** found defective in materials and /or workmanship **and** the associated **Labor** of the particular repair are covered under the terms of this limited warranty
- B) Second (2<sup>nd</sup>) and Third (3<sup>rd</sup>) Year of Original Ownership: **Parts** found defective in materials and /or workmanship are covered under the terms of this limited warranty.
  - Limited Battery Warranty: 90-day free battery replacement in the case of defects in materials and/or workmanship, thereafter prorated for the period from the fourth (4<sup>th</sup>) through the twelfth (12<sup>th</sup>) month of ownership.
  - "No-Fault Warranty": Covers the "No-Fault" to owner replacement of damaged belts, tires, seats, and grass bags (cutting blades are not included) for a period of One (1) month or One-Hundred (100) hours, whichever comes first.
  - Limited Engine Warranty: Parts and Labor for defects in materials and/or workmanship are covered for the first two (2) years of original equipment ownership. Refer to the Engine Manual for specific limitations and restrictions.

Accordingly, Cub Cadet Commercial will replace or repair any part or parts without charge through your authorized Cub Cadet Commercial dealer subject to the above time and coverage limitations. Upon completion of your purchase, the Serial Number/s of the unit will be registered with the Cub Cadet. This will initiate and validate your limited warranty and the applicable Warranty Period.

**What is Not Covered By this Warranty?** Cub Cadet Commercial does not warrant ( a ) routine maintenance items such as lubricants, filters (oil, fuel, air and hydraulic), cleaning, tune-ups, brake or clutch inspections, adjustments made as part of normal maintenance, blades, blade sharpening, equipment setup, and normal wear items; ( b ) incidental cost such as transporting equipment to and from the dealer, telephone charges or renting product temporarily to replace a warranted product; ( c ) damage caused by use of the equipment for purposes other than those for which it was designed; ( d ) damage caused by accident or Disasters such as fire, flood, wind and lightning; ( e ) damage caused by unauthorized attachments, modifications, alterations, improper servicing or maintenance, improper storage; or ( f ) any other abuse or misuse of the equipment.

**Exclusive Warranty.** The foregoing warranty is exclusive and in lieu of all other warranties or remedies, whether written, oral or implied. Any and all implied warranties of merchantability, fitness for particular purpose, course of dealing or usage of trade are hereby expressly disclaimed and excluded. **(Some states do not allow the exclusion or limitation of incidental or consequential damages, so the above exclusion or limitation may not apply to you.)**

**Limitation of Remedies.** Under no circumstances, except to the extent such exclusions are prohibited by applicable law, shall Cub Cadet Commercial be liable for any loss or damage, direct or indirect, special, incidental or consequential arising out of the use of or inability to use this equipment including but not limited to any claim for loss of profits, loss of profits, loss of savings or revenue, loss of use of the equipment or any associated equipment, facilities or continued service, downtime, the claims of costs of third parties including customers and injury to property. Some states do not allow limitations on how long an implied warranty lasts of the exclusion or limitation of incidental or consequential damages, so the above limitations or exclusion may not apply to you. **This warranty gives you specific legal rights, and you may also have other rights that vary from state to state.**

**Future Changes:** Cub Cadet Commercial reserves the right to reserve, change or modify the construction and design of its equipment or any component part or parts thereof without incurring the obligations to make such changes or modifications in present equipment.

**How to Obtain Service:** Contact the authorized Cub Cadet Commercial dealer at the point of original retail purchase to obtain service or replacement parts.

***Products purchased outside the USA are not covered by this warranty***

Cub Cadet LLC  
P.O. Box 361131  
Cleveland, Ohio 44136-0019  
1-877-282-8684