KODAK EASYSHARE Digital Frame



Extended user guide D830/D1030

www.kodak.com

For help with your digital frame, www.kodak.com/go/digitalframesupport

Kodak

Eastman Kodak Company

Rochester, New York 14650

© Eastman Kodak Company, 2009

All screen images are simulated.

Kodak, EasyShare, and Perfect Touch are trademarks of Eastman Kodak Company.

P/N 4H5193_en

Front/Side Views

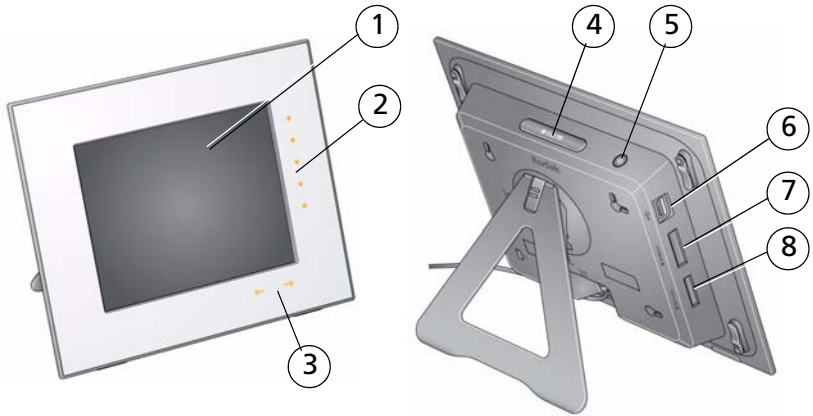

1 LCD screen

Quick Touch Borders:

2 Side touch lights—tap only

3 Bottom touch lights—slide between or tap arrows

4 Mode button

5 Power button 

6 USB connector

7 Memory card slot - SD/SDHC/MMC/MS/XD

8 Memory card slot - MS Duo/Pro Duo

NOTE: When your hand is within 1 - 3 inches (2.5 - 7.6 cm) of the borders, the lights turn on and indicate where to touch. Tap the lights to turn on the screen icons.

To use the Quick Touch Borders, see [page 4](#).

Back View

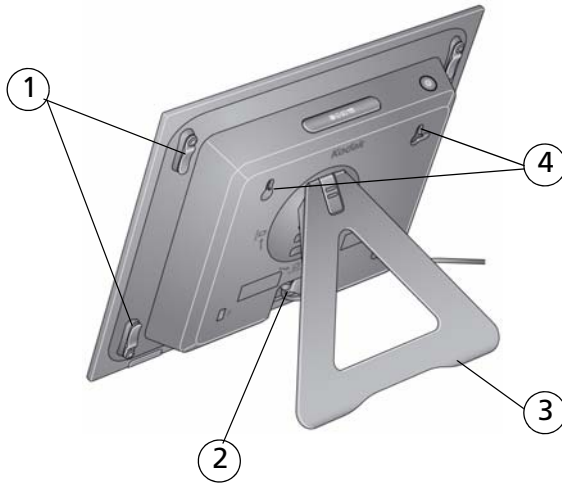

1 Faceplate attach clips (4)

2 DC-In 

3 Rotating stand

4 Wall mounting holes (3)

Table of contents

1 Getting started	1
Setting up your frame	1
Navigating using the Quick Touch Borders	4
Setting your language	6
Setting the clock, date, and timer	6
Inserting a memory card	8
Connecting a USB device	8
Attaching the included faceplate	9
2 Viewing pictures	10
Enjoying your pictures immediately!	10
Viewing your pictures	11
Changing viewing modes	12
Viewing pictures in collage mode	13
Viewing thumbnails	14
Viewing a single picture	15
Saving a default play location	15
3 Doing more with your frame	16
Accessing menu options	16
Selecting multiple pictures	18
Copying on your frame	19
Rotating pictures	20
Deleting pictures	20
Creating and playing a multimedia slide show	21
Changing your frame orientation	23
Adding a new standard picture frame	24
Hanging your frame on the wall	28
4 Changing settings and more	29

Changing frame settings	29
Settings menus	29
Upgrading your firmware (recommended).....	32
Maintaining your frame	33
Learning more about your frame.....	33
5 Troubleshooting and support	34
Picture frame problems	34
Screen messages.....	37
6 Appendix	39
Digital frame specifications.....	39
Important safety instructions	40
Upgrading your software and firmware.....	40
Additional care and maintenance	41
Limited warranty.....	41
Regulatory compliance and advisory	43

1

Getting started

Welcome to your KODAK EASYSHARE Digital Frame. Viewing and sharing your pictures couldn't be simpler!

Setting up your frame

Attaching the stand

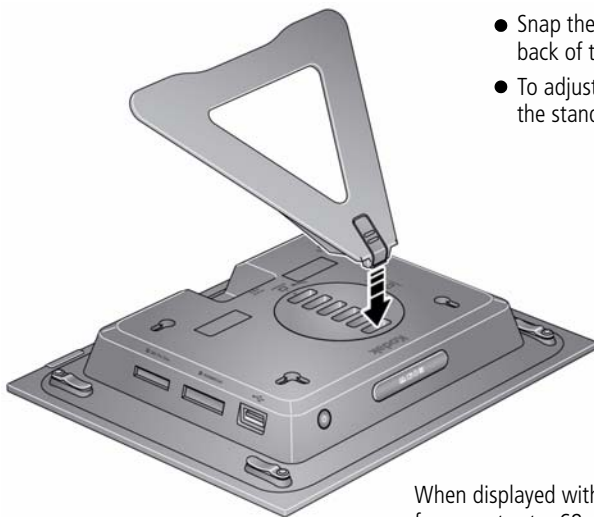

- Snap the stand into a slot in the back of the frame.
- To adjust the display angle, move the stand to a different slot.

When displayed with the stand extended, the frame rests at a 68 - 90 degree angle.

Your frame displays pictures in landscape orientation . To change to portrait orientation , see page 23.

Attaching the power cable



CAUTION:

Do not use this power cable with other devices, including digital cameras.

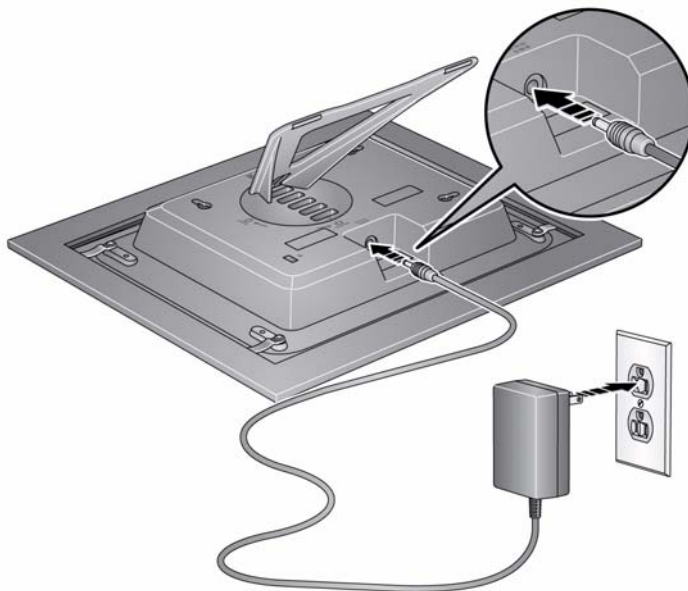

Your power cable may look different from the one pictured. Use the plug that accommodates your type of power outlet.

Turning your frame on and off

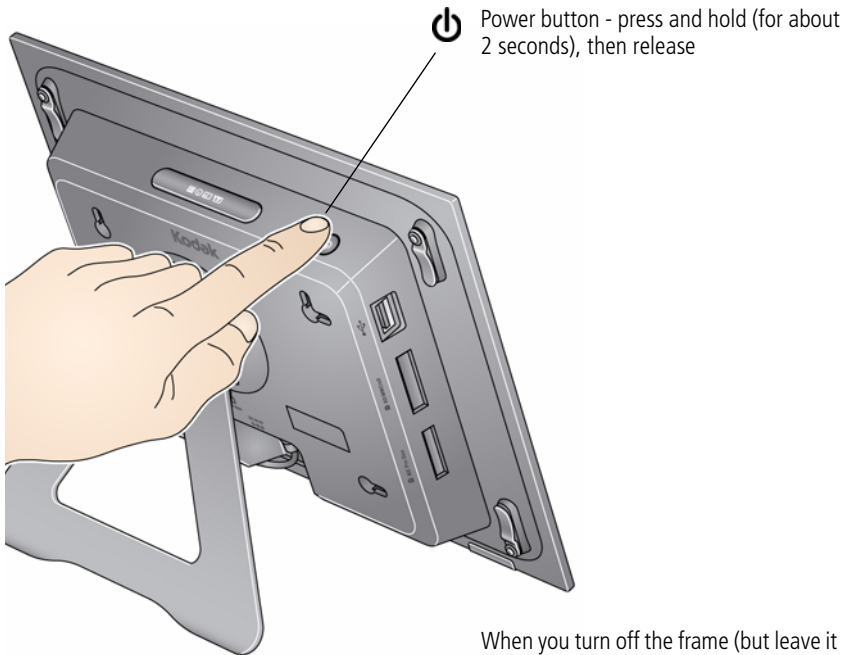

When you turn off the frame (but leave it plugged in), it retains information, like the time and date.

Navigating using the Quick Touch Borders

IMPORTANT: *The display screen is not touch-sensitive. Do not touch it. Instead, tap the lights in the right and bottom borders.*

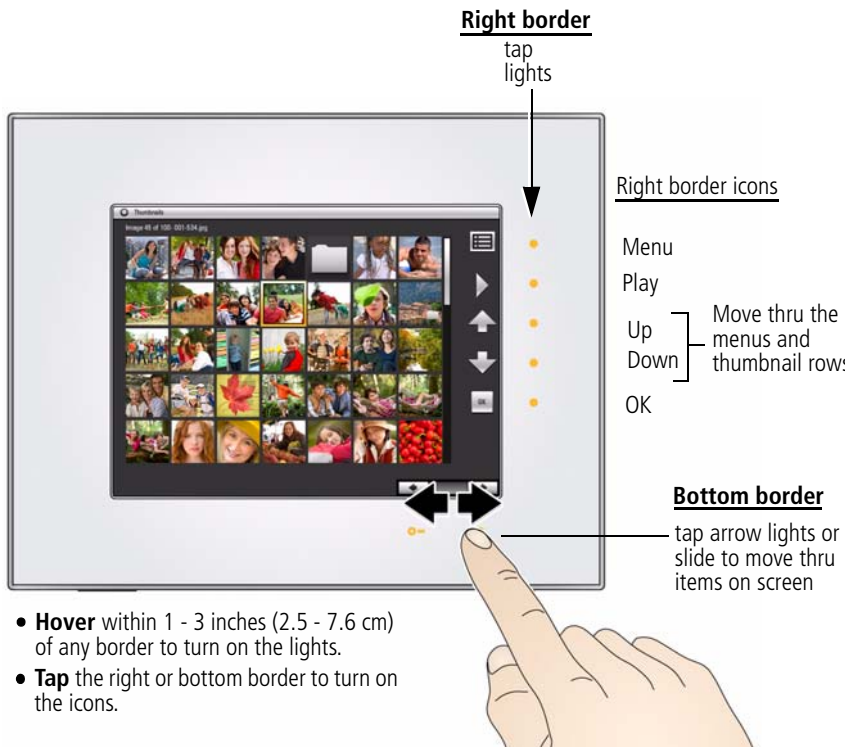

- **Hover** within 1 - 3 inches (2.5 - 7.6 cm) of any border to turn on the lights.
- **Tap** the right or bottom border to turn on the icons.





CAUTION:

Only use your finger on the borders. Borders do not react to sharp or metal objects—and they may damage the border or screen.

Tapping on the right border



- Tap the light next to an icon to select it. Icons change color when they're selected.
- Tap the light next to the up/down arrows  to move up or down through menus or rows of thumbnails.
- Tap the light next to OK or  to select the highlighted item.

Tapping and sliding on the bottom border



- Tap the arrow lights to move the highlight one picture, menu, or item at a time.
- Slide between the arrow lights to scroll through pictures: like turning the pages of a book, slide left ← to go forward, slide right → to go back.
- For faster scrolling through large numbers of thumbnail pictures, touch and hold an arrow light (3 seconds).

What 'tap' and 'slide' mean in this guide

Only the lights on the right and bottom Quick Touch Borders are touch-sensitive. The screen and other borders are not.

In this guide, 'tap or slide' means 'tap or slide on the light next to or under an icon or button'. It does not mean 'tap the icon on the screen.'

For example: 'Tap  (Menu)' means 'Tap the light on the Quick Touch Border next to the  (Menu) icon.'



Setting your language

The language screen appears the first time you turn on your frame.



- Tap the light next to an up/down arrow  to highlight your language, then tap OK.

To change the language at a later time:



- Tap  (Menu). Tap the down arrow to highlight  (Settings); tap the down arrow to highlight Language.
- The language screen appears.*
- Tap an up/down arrow to highlight your language, then tap OK.

To use the Quick Touch Borders, see [page 4](#).

Setting the clock, date, and timer

If this is the first time you turned on your frame, the Clock and Date screen appears automatically after you select your language. Follow steps 3, 4, and 6 below.

To change or set the clock, date, and automatic timer later, follow all the steps below.

- 1 Tap  (Menu), then tap the down arrow  to highlight  (Settings). Tap OK.
- 2 Tap the down arrow to highlight Clock and Date, then tap OK.



Slide between the arrow lights.
Press and hold to move quickly
through the time and date
settings.

3 Set the clock.

Tap the down arrow  to highlight Clock, then slide or tap between the left/right arrow lights to select the current time (based on a 24-hour clock).

4 Set the date.

Tap the down arrow to highlight Year/Month/Day, then slide or tap between the left/right arrow lights to select the current date (three separate settings).

5 Set automatic on and off times.

Specify the times you want your frame to automatically turn on and off.

NOTE: Make sure the on time is earlier than the off time.

- a Tap the down arrow  to highlight Auto Off Auto On, then tap OK to change the option to Enabled.
- b Tap the down arrow to highlight Turn Frame On At, then slide or tap between the left/right arrow lights to select the On time (based on a 24-hour clock).
- c Tap the down arrow to highlight Turn Frame Off At, then slide or tap between the left/right arrow lights to select the Off time (based on a 24-hour clock).

6 Tap OK to save your settings and close the menu screen.

To close the screen without saving, tap Exit.

If your frame loses power, the clock time returns to the factory setting, and the automatic on/off times, if set, are disabled. To reset the clock and re-enable your on/off times, see [Resetting the clock and calendar after losing power, page 36](#).

Inserting a memory card

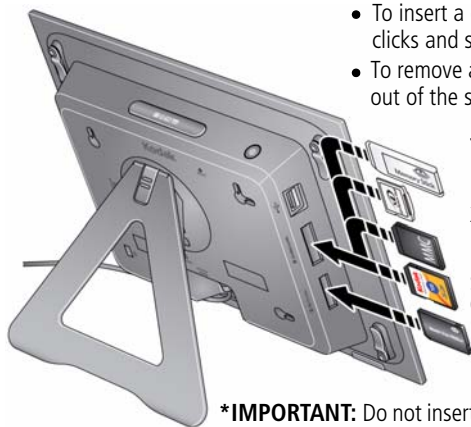

- To insert a card, push it firmly into the slot until it clicks and stops.
- To remove a card, push it in to release it, then pull it out of the slot.

Top slot*:

MS (MEMORY STICK)

XD

MMC (MULTIMEDIA Card)

SECURE DIGITAL/SECURE DIGITAL High Capacity (SD/SDHC)

Bottom slot:

MS/MS Pro Duo (MEMORY STICK)

***IMPORTANT:** Do not insert an MS Pro or MS Pro Duo card in the top slot. It may be difficult to remove.

Connecting a USB device



Supported USB devices include a flash drive, card reader, hard drive*, etc.

USB devices and cables are sold separately.

* External hard drives must be self-powered.

Attaching the included faceplate

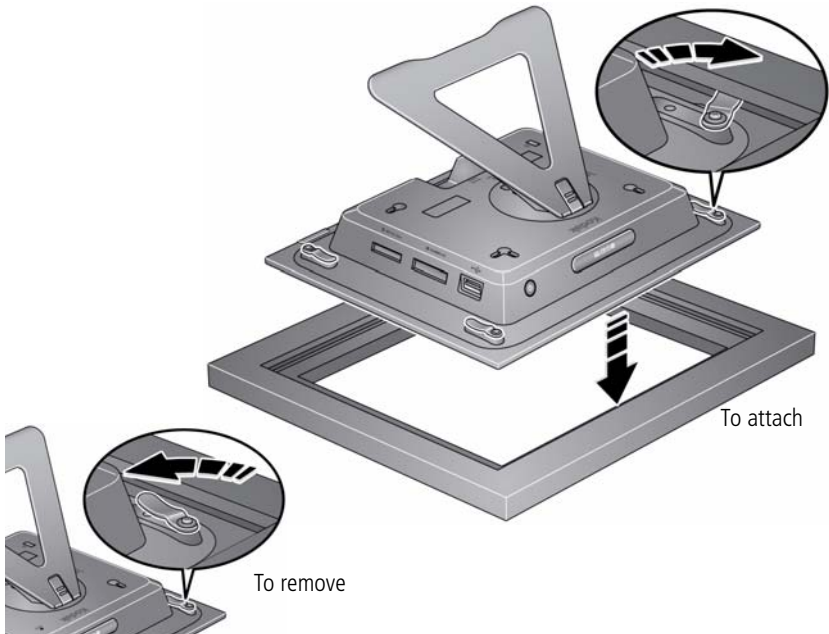

You can also personalize your KODAK EASYSHARE Digital Frame by putting a standard picture frame over the digital frame's panel. See [Adding a new standard picture frame](#), page 24.

2

Viewing pictures

View pictures from your frame's internal memory or any connected picture source (memory card, USB device).

Enjoying your pictures immediately!

To view your pictures or play a slide show, insert a memory card or other USB device (see [page 8](#)). Your pictures play automatically.







NOTE: Your frame may have pre-loaded pictures, which start playing if you do not insert a memory card or USB device with your own pictures.
You cannot delete the pre-loaded pictures.

Viewing your pictures

View your pictures from the frame's internal memory or any connected picture source.



- 1 Tap  (Menu), then tap  (Pictures).
All connected sources and internal memory are listed.
- 2 Tap an up/down arrow  to highlight a picture source, then:
 - Tap  (Play) to start a slide show of the pictures in the highlighted source.
 - Or, tap OK to view thumbnails of the pictures in the highlighted source.

Picture sources:



Default play location—appears when you save a picture source as your automatic go-to location (see page 15).



Internal memory—the frame's 512 MB internal memory. Copy your pictures into internal memory from a memory card or other device (see page 19).



Memory card—appears when you insert a card (see page 8). The label and icon indicate the type of card.



USB drive—appears when you insert a USB flash or other type drive (see page 8).

Playback information

- Picture display order:
 - When Shuffle is on (the default setting, see page 30), pictures play in random order.
 - When Shuffle is off, pictures play according to your Display Picture Order By setting, see page 31. The default is Old to new.

- You can change the duration (how long each picture stays on the screen) and transition style between pictures. See [Changing frame settings, page 29](#).
- Pictures play continuously until you turn off the frame or change modes.

Changing viewing modes

Press the Mode button for quick access to the four viewing modes on your frame: Pictures & Videos, Collage, Clock, and Calendar.

Each time you press the Mode button, the frame advances to the next mode.

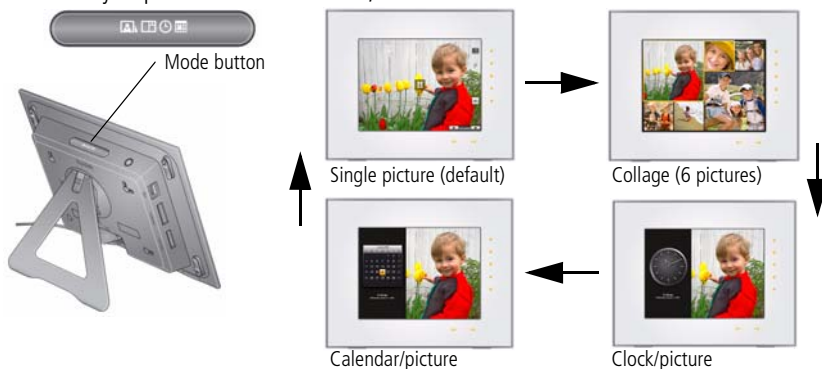

Viewing Modes



Pictures (default)—the pictures in your current picture source play one at a time ([see page 11](#)).



Collage—multiple pictures in your current picture source play on the screen ([see page 13](#)).



Clock—a clock with the current time is displayed on one side of the screen, while the pictures in your current picture source play on the other.





Calendar—a calendar with today's date highlighted is displayed on one side of the screen, while the pictures in your current picture source play on the other.

Viewing pictures in collage mode

View a revolving six-picture slide show. Press the Mode button to play your pictures in collage mode .



- Tap a right/left arrow  to highlight a different picture in the collage.
- Tap the right or bottom border to pause play and highlight the current picture.
- While play is paused, tap OK to display the highlighted picture in full screen, single view.
- While play is paused, tap  (Menu) to access the main menu options (see [page 16](#)).
- Tap  (Play) to resume collage play.



NOTE: Multimedia slide shows do not play in collage mode.

Viewing thumbnails

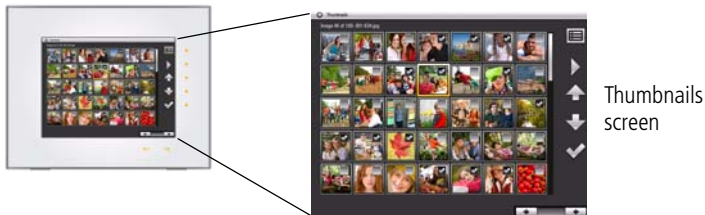

There are two ways to view your pictures as thumbnails:





First, from the picture source list:

- 1 Tap a touch border to display the icons, then tap  (Menu).
- 2 Tap  (Pictures).
- 3 Tap an up/down arrow  to select a picture source, then tap OK (see page 11).
Pictures are displayed as thumbnails.

Second, while pictures are playing or from a single view:

- 1 Tap a touch border to display the icons, then tap  (Menu).
- 2 Tap  (Thumbnails).
Pictures are displayed as thumbnails.

Tips when viewing thumbnails:

- To move to the next or previous row, tap the up/down arrows on the side Quick Touch Border.
- To move through the thumbnails, tap the arrows or slide your finger left/right along the bottom slider. To move even faster through the thumbnails, press and hold until the speed changes (about 3 seconds).
- To play a folder of images, highlight the folder then tap  (Play).
- To play a slide show, highlight the thumbnail and tap  (Play).



Viewing a single picture



- To view a single, full-screen picture, highlight it in thumbnails view, then tap OK.
- Or, when a slide show is playing, tap a Quick Touch Border (right or bottom). The slide show is paused and the picture in view is displayed. Tap OK to hide the icons and lights.

Saving a default play location

Save the picture source where you usually store your favorite pictures (internal memory, memory card, USB drive, etc.) as your default go-to location.

- 1 While viewing pictures, tap a Quick Touch Border.
Play is paused and the lights and screen icons appear.
- 2 Tap  (Menu), then  (Settings).
- 3 Tap an up/down arrow  to highlight Save as Default Play Location.
- 4 Tap the up/down arrows to highlight an option:
 - Yes—to confirm.
 - No—to exit the menu.
 - Clear my Default Play Location—to delete reference to the currently designated picture source.

The next time you turn on your frame, it will automatically start playing from the same source you were in when you entered the Settings Menu.

The Default Play Location icon  appears in the Pictures & Videos list as a picture source (see [page 11](#)).

3

Doing more with your frame

Accessing menu options

Use the Menu button to view and work with your pictures, and to change your frame settings (see page 29).

NOTE: As your hand approaches the frame, lights turn on indicating where to touch on the Quick Touch Borders. Tap the right border to see the screen icons.



1 Tap  (Menu).

2 Tap an up/down arrow  to highlight a menu option, then tap OK.

IMPORTANT: *You may need to keep tapping the up/down arrows to see a complete list of available options.*

NOTE: Menu options are displayed for one minute after selecting them.







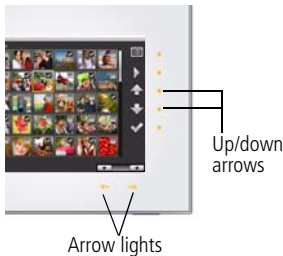

Tap OK after highlighting an option	Description
Pictures	View all available picture sources. Start here to play your pictures (see page 11).
Slide Shows	View and play all available multimedia slide shows (see page 22).
Thumbnails	View all pictures in your current picture source as thumbnails (see page 14).

Tap OK after highlighting an option	Description
Multi-select Available from the Thumbnails menu only	Select multiple pictures and videos for copy, rotate, delete, or play (see page 18).
Select/Deselect All	Select or deselect everything in your current picture source (see page 18).
Copy	See Copying on your frame, page 19 .
Rotate	See Rotating pictures, page 20 .
Delete	See Deleting pictures, page 20 .
Settings	Customize how you use your frame and how you view your pictures and videos. See Chapter 4, Changing settings and more .

Selecting multiple pictures

Use the multi-select feature to copy, delete, or rotate multiple pictures at once. Or select just the pictures you want to play in a slide show.



- 1 Tap  (Menu), then tap the down arrow  to highlight Thumbnails. Tap OK.
- 2 Tap the down arrow  to highlight Multi-Select, then tap OK.
- 3 To find and highlight a picture, tap the arrow lights or slide between them, then tap  (Select).
A check mark appears on the selected picture.
- 4 Continue selecting pictures.
 - Tap the up/down arrows  to move to the next or previous row.
 - To remove a check mark, tap  (Deselect) while the picture is highlighted.
 - To select all pictures at once, tap  (Menu), then tap Select All.
 - To deselect all pictures at once, tap  (Menu), then tap Deselect All.
 - To quickly deselect many pictures, tap  (Menu), then tap Select All, then tap Deselect All.

Copying on your frame

Copy pictures or slide shows from your current viewing location to other connected devices (see [page 8](#)). For example, copy pictures from a memory card* into your frame's internal memory.

* HINT: Share the digital pictures from your camera or computer—take the card out of your camera or copy pictures from your computer to a memory card. Then copy them into your frame's internal memory and share with friends and family, anywhere!





CAUTION:

Removing a card or disconnecting a device while copying may damage your card, pictures, or device.

- 1 Highlight a picture in thumbnails view (see [page 14](#)) or display it in single view (see [page 15](#)).

To select multiple pictures, see [page 18](#).

- 2 Tap  (Menu), then tap  (Copy).

- 3 Tap an up/down arrow  to highlight the copy-to destination, then tap OK.

The picture is copied.

- 4 Tap OK to dismiss the screen.

Notes on copying to internal memory



When you copy pictures into the frame's internal memory, the copies are automatically resized to a lower resolution (smaller size). Full resolution is unnecessary for viewing and quickly fills up the frame's memory.

To turn off the automatic resizing feature, tap Menu → Settings → Automatic resizing (see [Settings menus, page 29](#)).

Rotating pictures

- 1 Highlight a picture in thumbnails view (see [page 14](#)) or display it in single view (see [page 15](#)).

To select multiple pictures, see [page 18](#).

- 2 Tap  (Menu), then tap  (Rotate).

- 3 Tap an up/down arrow  to highlight the direction and degree of rotation, then tap OK.

Highlight Exit and tap OK to return to the picture without rotating it.

Deleting pictures





CAUTION:

Removing a card or disconnecting a device while deleting may damage your card, pictures, or device.

- 1 Highlight a picture in thumbnails view (see [page 14](#)) or display it in single view (see [page 15](#)).

To select multiple pictures, see [page 18](#).

- 2 Tap  (Menu), then tap  (Delete).

- 3 Highlight Yes to confirm.

- 4 Tap OK to delete the picture and return to the menu.

To change your mind, highlight No, then tap OK to return to the menu.

Creating and playing a multimedia slide show

Use KODAK EASYSHARE Digital Display Software on your computer to create a multimedia slide show (WINDOWS OS only). Then copy the slide show to your frame.

NOTE: D830/D1030 Digital Frames do not support audio or video playback. Therefore, audio and video portions of a multimedia slide show (if included) do not play on your frame.

Before you proceed, make sure you download and install the software.

Download EASYSHARE Digital Display Software

Download and install the latest version of KODAK EASYSHARE Digital Display Software—www.kodak.com/go/digitalframedownloads.

- 1 Select Software in the product type drop-down menu.
- 2 Select Digital Display Software in the software package drop-down menu, then click Go.
- 3 Select your operating system, then follow the screen directions to download and install KODAK EASYSHARE Digital Display Software.

The software icon  appears on your desktop when the installation is complete.

- 4 Double-click  to open EASYSHARE Digital Display Software (if it doesn't open automatically).

When prompted, take a few minutes to electronically register your frame and software for exclusive tips and offers. To register later, visit www.kodak.com/go/register.

Creating a multimedia slide show

- 1 Double-click the KODAK EASYSHARE Digital Display Software icon on your desktop to open the software .

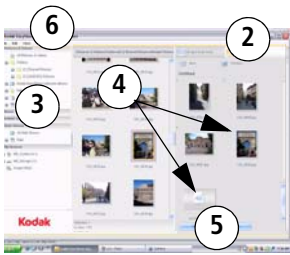



- 2 Click the Slide Show Editor tab.
- 3 In Picture & Videos, click the folder or location that contains the files you want to add to the slide show.
- 4 In the Viewer pane, select the pictures, then drag and drop them to the Slide Show Editor.
Drag pictures in the Editor to change the play order.
- 5 Click Save.
- 6 For more details on creating multimedia slide shows, click Help.

Copying a multimedia slide show to your frame

On your computer, use Digital Display Software to copy your multimedia slide shows to a memory card or USB flash drive. Here's how:

- 1 In the navigation pane under Slide Shows, click a multimedia slide show.
- 2 Drag the slide show to a connected card or USB drive in the Drag & Drop Zone.
For more details on copying from Digital Display Software to a connected device, click the Help button in the software.
- 3 Insert the card or USB drive into your frame. Follow the directions for copying on [page 19](#).

Playing a multimedia slide show on your frame

- 1 Tap  (Menu), then tap Slide Shows.
- 2 Highlight a slide show icon, then tap  (Play).

The slide show begins playing.

Changing your frame orientation

Your frame is set up to display pictures and videos in landscape orientation. You can turn the frame on its side to change the orientation to portrait. But, you must also change the orientation setting to portrait.







Change the stand position



- Rotate the stand 90 °.
- To adjust the display angle, move the stand to a different slot.

Change the frame orientation setting

- 1 Tap  (Menu), then tap  (Settings).
- 2 Tap the down arrow  to highlight Frame Orientation, then tap OK.
- 3 Tap the down arrow to highlight Portrait, then tap OK.
- 4 Tap  to exit.

Adding a new standard picture frame

You can personalize your KODAK EASYSHARE Digital Frame by putting a standard picture frame over the digital frame's panel. Match your home décor and style by choosing from the thousands of standard picture frames on the market, even a favorite you might already have.

Choosing a standard picture frame size

KODAK EASYSHARE Digital Frame model	Use a standard picture frame that accommodates this photo size (without a matte)
D830	8" x 10" (20.3 x 25.4 cm)
D1030	10" x 13" (25.4 x 33 cm)

Standard picture frames have different attachment styles. Your digital frame fits these most commonly available styles of standard frames:

- Slot—frames with a slot around the inside perimeter ([see page 26](#))
- Clip—frames with a rotating clip around the perimeter of the frame ([see page 27](#))
- Tab—frames with bendable metal tabs ([see page 28](#))

Picture frame styles that don't fit

Several standard picture frame styles are not compatible with your KODAK EASYSHARE Digital Frame. A compatible standard picture frame must accept the dimensions of the digital frame's attachment area. The general dimensions of the attachment areas are:

KODAK EASYSHARE Digital Frame model	Digital frame's attachment area dimensions
D830	8" x 10" x 0.165" deep (20.3 x 25.4 x .4 cm)
D1030	10" x 13" x 0.165" deep (25.4 x 33 x .4 cm)

The following types of standard picture frames will not fit on your EASYSHARE Digital Frame.

- Frames that secure a photo by pressing it between two pieces of glass.
- A deep frame that's designed to hold 3-dimensional objects instead of photos.
- Frames with inserts in which the insert holds the standard picture size.
- Frames with a hinged or otherwise non-removable back.
- Frames with a curved or uneven mounting surface.
- Frames with a round, oval, or other non-rectangular mounting area.
- Frames in which you slide the picture into one end.*
- Handcrafted frames.*

* You may be able to use these frame types. Check for individual frame compatibility.

General attachment details

- 1 If the faceplate that was packaged with your frame is attached, remove it ([see page 9](#)).
- 2 Remove the back, backing material, and the glass from the standard picture frame. Use CAUTION when handling the glass, the edges are sharp.

Store the original faceplate and contents of the standard picture frame in the box that came with your digital frame. Keep for later use.

NOTE: **You must remove the glass.** The digital frame's Quick Touch Border will not work with the glass in place.

- 3 Place the standard picture frame face down on a protected flat surface, and place the digital frame into the picture frame.
- 4 Attach the frames together according to the following directions. Keep any leftover foam spacers for later use.
- 5 When attached, make sure the digital frame is secure within the picture frame and can't shift or move around.

Attach a slot-style standard picture frame

SLOT-style

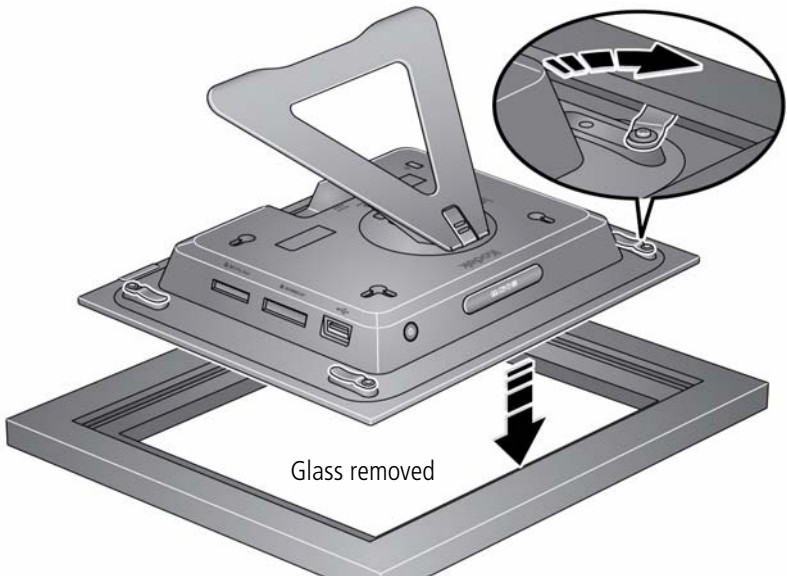

- Use the clips that are attached to the digital frame's back panel.
- Rotate and depress the clips as needed to engage the slot in the standard frame.

If necessary:

- If a deep picture frame places the slot above the clips, carefully bend the clips up—slightly above the slot. Then, rotate and depress the clips to slide them into the slot.
- Tighten the screws to secure the clips. Be careful not to over-tighten.

Attach a clip-style standard picture frame

CLIP-style

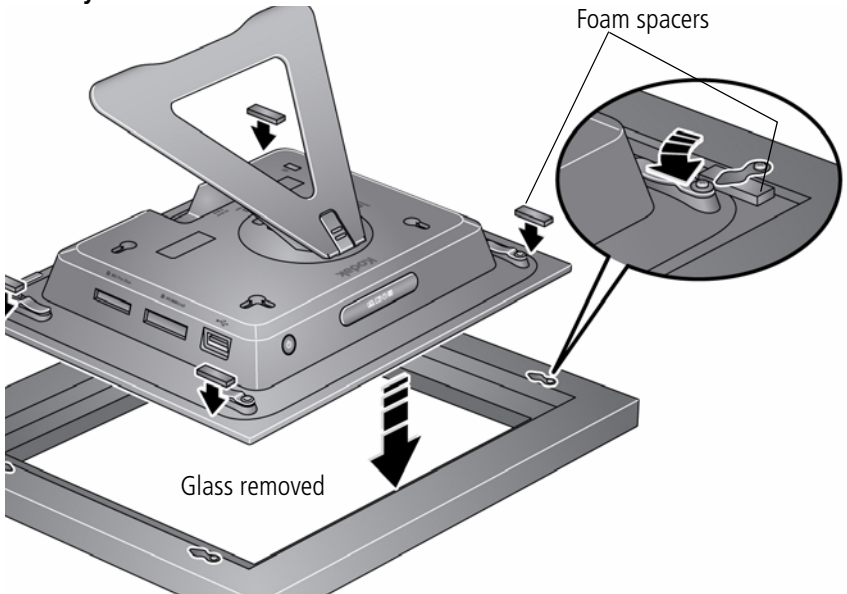

- Use the clips that are attached to the standard picture frame.
- Use the included self-stick foam spacers to fill any gap between the digital frame's back panel and the clips on the standard frame. Stack the spacers if necessary. Avoid adding more spacers than necessary to prevent excessive force against the clips.

If necessary:

- Tighten the screws to secure the clips. Be careful not to over-tighten.

Attach a bendable metal tab-style standard picture frame

TAB-style

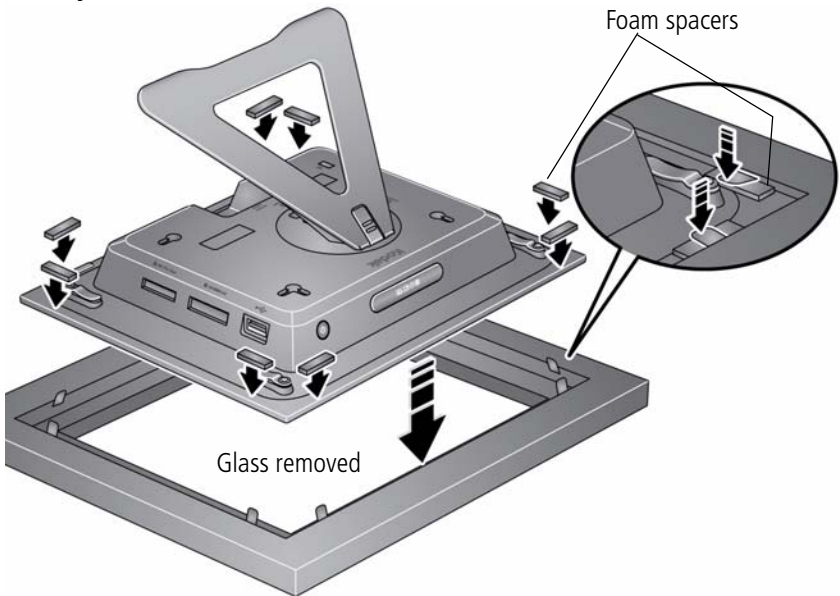

- Bend the metal tabs down to secure the digital frame to the standard frame.
- If necessary, use the included self-stick foam spacers to fill any gap between the digital frame's back panel and the metal tabs.

Hanging your frame on the wall

To hang your frame on the wall, remove the stand, then use wall anchoring hardware (not included) to securely mount the frame to the wall.

See [Back View, page ii](#) for the location of the mounting holes.





4

Changing settings and more

Changing frame settings

The options in the Settings menu let you customize and configure your frame.

IMPORTANT: *You may need to keep tapping the up/down arrows to see the complete list of available options.*

- 1 Tap  (Menu), then tap  (Settings).
- 2 Tap the up/down arrows  to highlight a setting, then tap OK.
- 3 Follow the on-screen instructions. Tap OK to accept your selections.
- 4 Tap  (Play) to return to playback from the current image. Tap  (Menu) to return to the top level menu.

Settings menus

Setting	Options
Upgrade Firmware This setting is only available if the upgrade file (.img) is present on the frame (on an inserted memory card or flash drive, or copied into internal memory).	Install now —load the latest version of firmware on your frame (page 32). Exit —return to the main menu.
Duration	Specify how long each picture is displayed, from 3 seconds to 1 hour. The default is 5 seconds.
Transition	Specify the transition style between pictures during playback. See screen for options. The default is Random.



Setting	Options
<p>Default Play Location Save the current picture source as your default go-to location.</p>	<p>Yes—confirm the current picture source as your default go-to location. No—exit the menu. Clear My Default Play Location—delete reference to the currently designated picture source. See Saving a default play location, page 15.</p>
<p>Shuffle</p>	<p>On (default)—play pictures in random order. Off—play pictures by the current Display Picture Order By setting (see page 31).</p>
<p>Slide Show Starting Point Specify where playback starts when Display Picture Order By setting is Oldest to newest (see page 31).</p>	<p>Most recent week (default)—start playback with the last week of pictures. Oldest picture—start playback with the oldest picture available. This setting only applies when Display Picture Order By setting is Old to new (see page 31).</p>
<p>Brightness Drag the slider to adjust the screen brightness.</p>	<p>1 (darkest) to 10 (lightest).</p>
<p>Frame Orientation Change this setting if you turn your frame to display it in a different orientation.</p>	<p>Landscape (default) <input type="checkbox"/> Portrait <input type="checkbox"/> See Change the frame orientation setting, page 23.</p>
<p>Automatic Resizing This setting applies when you copy pictures into the frame's internal memory. Copies are automatically resized to a lower resolution (smaller size).</p>	<p>On (default)—copy pictures to internal memory at a lower resolution (smaller size). Off—copy pictures to internal memory at full resolution. See page 19. Full resolution is unnecessary for viewing and quickly fills up the frame's memory.</p>

Setting	Options
Fit or Fill Specify how to scale the pictures on the screen.	Fit —show the whole picture. Black borders may appear around the image. Fill (default) —the picture fills the entire screen; some of the picture may be cut off (cropped).
KODAK PERFECT TOUCH Technology Automatically enhance your pictures to look their best on your frame.	On —automatically enhance your pictures. Off (default) —display pictures without corrections.
Display Picture Order By Specify the order in which to play your pictures—by date or file name. NOTE: If Shuffle is On, pictures play in random order, regardless of this setting.	Old to new (default) —start play with the oldest file date. New to old —start play with the most recent file date. A - Z —start play alphabetically from A to Z. Z - A —start play alphabetically from Z to A.
Clock & Date See Setting the clock, date, and timer, page 6 .	Clock —set the current time. Year —set the current year. Month —set the current month. Day —set the current day of the month. Auto Off Auto On —set automatic on and off times.
Language	Choose your language (page 6).
About this frame	Check your frame model, serial number, and firmware version.
Exit	Return to the top menu with no actions performed or saved.

Upgrading your firmware (recommended)

Firmware is the software that runs on your frame. To check for the latest version, visit www.kodak.com/go/digitalframedownloads.

Download the firmware to your computer, then upgrade your frame:

- 1 On your computer, go to www.kodak.com/go/digitalframedownloads.
- 2 Follow the screen directions to download the frame firmware to your computer.
- 3 Copy the IMG file to the root directory (not in a folder or subfolder) of a memory card or USB flash drive, then insert into the frame.
- 4 Tap  (Menu), then tap  (Settings).
- 5 Highlight Firmware Upgrade, then tap OK to begin the upgrade.

IMPORTANT: *Do not turn off the frame or remove the memory card or USB flash drive during the upgrade!*

When the upgrade is complete, your frame automatically restarts. If it doesn't, press the power button on the frame to Off, then back to On.

Maintaining your frame

IMPORTANT: *Always disconnect the power before cleaning. Do not use water, cleaning solutions, or other adhesives on the frame or any of its parts.*

Gently wipe the frame and screen with a clean, dry, lint-free cloth. For fingerprints on the frame, apply light pressure.

Learning more about your frame

www.kodak.com/go/digitalframes

Learn more about your frame

www.kodak.com/go/digitalframesupport

Interactive troubleshooting and repairs

Interactive tutorials

Frequently asked questions

Downloads

Product registration

5

Troubleshooting and support

For step-by-step product support, visit www.kodak.com/go/digitalframesupport and select Step-by-Step Solutions & Repair.

Picture frame problems

If...	Try one or more of the following
Frame does not turn on.	<ul style="list-style-type: none"> ■ Make sure the power cable that was included with your frame is connected securely (see page 2). ■ Unplug the power cable for 5 seconds, then reconnect the cable. Press and hold the power button (for about 2 seconds), then release.
Nothing happens when a memory card or USB device is connected.	<ul style="list-style-type: none"> ■ Insert a certified SD/SDHC/MMC/XD Card, with images, into the upper designated card slot, then push to seat it (see page 8). ■ Insert a certified MS Duo/Duo Pro Card, with images, into the lower designated card slot only, then push to seat it (see page 8). <p>NOTE: Do not insert an MS Pro or MS Pro Duo card in the top slot. It could get stuck and damage the card or your frame.</p> <ul style="list-style-type: none"> ■ Make sure the USB device is connected securely (see page 8). ■ Make sure the file format of your pictures is supported. (See page 39). <p>NOTE: Pictures may take a longer time to display when the files are large or when using a large capacity memory card or other connected device.</p>
Touch border doesn't work.	<ul style="list-style-type: none"> ■ Use your finger to make your selections on the Quick Touch Borders (see page 4). Lights on the border show you where to touch. <p>IMPORTANT: <i>Do not slide on the right border (tap only).</i></p> <ul style="list-style-type: none"> ■ Unplug the power cable for 5 seconds, then reconnect the cable. Press and hold the power button (for about 2 seconds), then release.

If...	Try one or more of the following
<p>Frame freezes up or doesn't work properly.</p>	<ul style="list-style-type: none"> ■ Unplug the power cable for 5 seconds, then reconnect the cable. Press and hold the power button (for about 2 seconds), then release. ■ Reset the frame. Press the Mode and Power buttons (see page ii) at the same time, then tap Yes to reset the frame. (Resetting your frame does not erase your saved files.)
<p>You set automatic on/off but the frame doesn't turn on and off at the specified times.</p>	<ul style="list-style-type: none"> ■ If your frame loses power, the clock returns to the factory setting and auto on/off times are disabled. See Resetting the clock and calendar after losing power, page 36.
<p>Cannot copy pictures from one device (memory card or USB flash drive) to another even though the copy destination is not full.</p>	<p>Storage devices that have FAT (File Allocation Table) 16 formatting can only store up to 512 files in the top level (root) directory. To make sure all your pictures copy properly, format the copy destination to FAT32 before copying to it:</p> <p>Caution: Formatting deletes all pictures and videos, including protected files.</p> <ol style="list-style-type: none"> 1 Connect the device to your computer. 2 Open My Computer and locate the device. 3 Right-click on it and choose Format. 4 From the File system drop-down menu, choose FAT32 then click Start.

Resetting the clock and calendar after losing power

If you turn off the power on the frame or otherwise lose power for half a day or more, the clock and calendar return to the factory setting and the automatic on/off times, if set, are disabled.

When you turn the frame back on, the set time and date screen appears.

1 Set the clock.

Tap the arrow lights or slide to select the current time.

2 Set the date.

Tap the down arrow to highlight Date, then tap the arrow lights or slide to select the current date.

3 Tap the down arrow to highlight Save, then tap OK.

The time is reset and the automatic on/off times (if set) are re-enabled. It is not necessary to reset the on/off times.

NOTE: If you exit the set time screen without setting the time, you can manually reset the clock and re-enable the automatic on/off times ([see page 6](#)). It is not necessary to reset the on/off times.

Screen messages

Screen message	Try one or more of the following
File is bad. (usually preceded by the file name. For example: xxx_xxxx.JPG <i>file is bad</i>)	The frame is unable to display the picture because the file is corrupted or it's an unsupported file format (see page 39).
Create file failed.	The device (memory card, USB drive, etc.) you are trying to copy to is protected. <ul style="list-style-type: none"> ■ See your device documentation to remove write protection. ■ Insert or connect a different device.
Write failed. Select another location.	The frame was unable to copy the picture. <ul style="list-style-type: none"> ■ Insert a different card or device (page 8).
Unable to create file. Device write protected or full.	The frame was unable to copy the picture. <ul style="list-style-type: none"> ■ Insert a different card or device (page 8).
Disk full.	<ul style="list-style-type: none"> ■ Remove write protection, unlock card. ■ Delete pictures from card.

Screen message	Try one or more of the following
Error attempting to open file or directory.	<p data-bbox="426 181 915 307">■ Turn off the frame, then turn it back on. Press and hold the power button (for about 2 seconds), then release. If the problem persists, contact customer support help, at www.kodak.com/go/digitalframesupport.</p>
Error duplicate filename.	
Error occurred while closing a file.	
Error invalid filename.	
Error reading from file.	
Error writing from file.	
Error writing a file.	
Error writing to a file.	
File Copy Failed!	
Internal error.	
Parameter is invalid.	
Unknown error.	

6

Appendix

Digital frame specifications

For more specifications, visit www.kodak.com/go/digitalframesupport.

KODAK EASYSHARE D830/D1030 Digital Frames	
Color display	
D830	20.3 cm (8 in.) diagonal digital LCD, 800 x 600 pixels, 4:3 aspect ratio, 16.3 x 11.4 cm (6.4 x 4.8 in.) viewable area
D1030	26.4 cm (10.4 in.) diagonal digital LCD, 800 x 600 pixels, 4:3 aspect ratio, 21.1 x 15.8 cm (8.3 x 6.2 in.) viewable area
Internal storage capacity	
D830, D1030	512 MB
Power supply	
D830	Manufacturer, Model #: Malata MPA-05015, EIAJ class 2 DC plug Input: 100-240V AC 50/60 Hz. Output: 5V DC 1.5 Amp
D1030	Manufacturer, Model #: Malata MPA-520, EIAJ class 2 DC plug Input: 100-240V AC 50/60 Hz. Output: 5V DC 2.0 Amp
Communication with USB devices	
USB High Speed Type A	
Other features	
Picture formats	JPEG, EXIF 2.2
Memory cards see page 8	Top card slot: SD/SDHC (SECURE DIGITAL/SECURE DIGITAL High Capacity); MMC (MULTIMEDIA Card); MS (MEMORY STICK); XD Bottom card slot: MS (MEMORY STICK) Pro/Pro Duo
Temperature	Operating: 32 to 122° F (0 to 50° C) Storage: -4 to 140° F (-20 to 60° C)

KODAK EASYSHARE D830/D1030 Digital Frames	
Size (w/o faceplate)	D830: 25.3 x 20.2 x 3.5 cm (10 x 7.9 x 1.4 in.) D1030: 32.9 x 25.3 x 3.5 cm (13 x 10 x 1.4 in.)
Weight (w/o faceplate)	D830: 843 gm (1.9 lb.) includes frame, stand, and AC adapter D1030: 1227 gm (2.6 lb.) includes frame, stand, and AC adapter

Important safety instructions



CAUTION:

Do not disassemble this product; there are no user-serviceable parts inside. Refer servicing to qualified service personnel. KODAK AC Adapters and Battery Chargers are intended for indoor use only. The use of controls, adjustments, or procedures other than those specified herein may result in exposure to shock and/or electrical or mechanical hazards. If the LCD breaks, do not touch the glass or liquid. Contact Kodak customer support.

- The use of an accessory that is not recommended by Kodak may cause fire, electric shock, or injury. For approved accessories, visit www.kodak/go/accessories.
- Use only the AC adapter that was packaged with your frame. Use of other AC adapters may damage the frame and void your warranties.
- When displayed with the stand extended, the frame rests at a 68 - 90° angle.
- Do not place frame near open flame sources such as lighted candles or heaters.
- Do not expose this product to liquid, moisture, or extreme temperatures.

Upgrading your software and firmware

Upgrade to the latest versions of the KODAK EASYSHARE Software and the frame firmware— www.kodak.com/go/digitalframedownloads. See [page 32](#) for upgrading firmware.

Additional care and maintenance

- To clean the frame or screen, use a soft, lint-free cloth dampened with lens cleaning solution or a water-based cleaning solution. Use light pressure.
- Do not allow chemicals, such as suntan lotion, to contact painted surfaces.
- Service agreements are available in some countries. Contact a dealer of Kodak products for more information.
- For digital frame disposal or recycling information, contact your local authorities. In the US, visit the Electronics Industry Alliance at www.eiae.org or visit www.kodak.com/go/digitalframesupport.

Limited warranty

Kodak warrants Kodak consumer electronic products and accessories ("Products"), excluding batteries, to be free from malfunctions and defects in both materials and workmanship for one year from the date of purchase. Retain the original dated sales receipt. Proof of the date of purchase will be required with any request for warranty repair.

Limited warranty coverage

Warranty service is only available from within the country where the Products were originally purchased. You may be required to ship Products, at your expense, to the authorized service facility for the country where the Products were purchased. Kodak will repair or replace Products if they fail to function properly during the warranty period, subject to any conditions and/or limitations stated herein. Warranty service will include all labor as well as any necessary adjustments and/or replacement parts. If Kodak is unable to repair or replace a Product, Kodak will, at its option, refund the purchase price paid for the Product provided the Product has been returned to Kodak along with proof of the purchase price paid. Repair, replacement, or refund of the purchase price are the sole remedies under the warranty. If replacement parts are used in making repairs, those parts may be remanufactured, or may contain remanufactured materials. If it is necessary to replace the entire Product, it may be

replaced with a remanufactured Product. Remanufactured Products, parts and materials are warranted for the remaining warranty term of the original Product, or 90 days after the date of repair or replacement, whichever is longer.

Limitations

This warranty does not cover circumstances beyond Kodak's control. This warranty does not apply when failure is due to shipping damage, accident, alteration, modification, unauthorized service, misuse, abuse, use with incompatible accessories or attachments (such as third party ink or ink tanks), failure to follow Kodak's operation, maintenance or repacking instructions, failure to use items supplied by Kodak (such as adapters and cables), or claims made after the duration of this warranty. Kodak makes no other express or implied warranty for this product, and disclaims the implied warranties of merchantability and fitness for a particular purpose. In the event that the exclusion of any implied warranty is ineffective under the law, the duration of the implied warranty will be one year from the purchase date or such longer period as required by law. The option of repair, replacement, or refund is Kodak's only obligation. Kodak will not be responsible for any special, consequential or incidental damages resulting from the sale, purchase, or use of this product regardless of the cause. Liability for any special, consequential or incidental damages (including but not limited to loss of revenue or profit, downtime costs, loss of the use of the equipment, cost of substitute equipment, facilities or services, or claims of your customers for such damages resulting from the purchase use or failure of the Product), regardless of cause or for breach of any written or implied warranty is expressly disclaimed.

Your rights

Some states or jurisdictions do not allow exclusion or limitation of incidental or consequential damages, so the above limitation or exclusion may not apply to you. Some states or jurisdictions do not allow limitations on how long an implied warranty lasts, so the above limitation may not apply to you. This warranty gives you specific rights, and you may have other rights which vary from state to state or by jurisdiction.

Outside the United States and Canada

In countries other than the United States and Canada, the terms and conditions of this warranty may be different. Unless a specific Kodak warranty is communicated to the purchaser in writing by a Kodak company, no warranty or liability exists beyond any minimum requirements imposed by law, even though defect, damage, or loss may be by negligence or other act.

Regulatory compliance and advisory

FCC compliance and advisory



This equipment has been tested and found to comply with the limits for a Class B digital device, pursuant to Part 15 of the FCC Rules. These limits are designed to provide reasonable protection against harmful interference in a residential installation. The equipment generates, uses, and can radiate radio frequency energy and, if not installed or used in accordance with the instructions, may cause harmful interference to radio communications. However, there is no guarantee that interference will not occur in a particular installation. If this equipment does cause harmful interference to radio or television reception, which can be determined by turning the equipment off and on, the user is encouraged to try to correct the interference by one or more of the following measures: 1) reorient or relocate the receiving antenna; 2) increase the separation between the equipment and the receiver; 3) connect the equipment to an outlet on a circuit different from that to which the receiver is connected; 4) consult the dealer or an experienced radio/TV technician for additional suggestions. Any changes or modifications not expressly approved by the party responsible for compliance could void the user's authority to operate the equipment. Where shielded interface cables have been provided with the product or specified additional components or accessories elsewhere defined to be used with the installation of the product, they must be used in order to ensure compliance with FCC regulation.

Canadian DOC statement

DOC Class B Compliance—This Class B digital apparatus complies with Canadian ICES-003.

Observation des normes-Classe B—Cet appareil numérique de la classe B est conforme à la norme NMB-003 du Canada.

CE

Hereby, Eastman Kodak Company declares that this Kodak Product is in compliance with the essential requirements and other relevant provisions of Directive 1999/5/EC.

Licensing

Supply of this product does not convey a license nor imply any right to distribute content created with this product in revenue-generating broadcast systems (terrestrial, satellite, cable and/or other distribution channels), streaming applications (via Internet, intranets and/or other networks), other content distribution systems (pay-audio or audio-on-demand applications and the like) or on physical media (compact discs, digital versatile discs, semiconductor chips, hard drives, memory cards and the like). An independent license for such use is required. For details, please visit <http://mp3licensing.com>.

Australian C-Tick



N137

Waste Electrical and Electronic Equipment labeling/battery disposal



In Europe: For human/environmental protection, it is your responsibility to dispose of this equipment at a collection facility established for this purpose (separate from municipal waste). For more information, contact your retailer, collection facility, or appropriate local authorities; or visit www.kodak.com/go/recycle.



Product weight with adapter and stand: D830, 843 gm. D1030, 1227 gm

Russian GOST-R

D1030:



Eastman Kodak Company
Rochester, New York 14650

D830:



Фотокамера изготовлена в Китае; остальные элементы - в соответствии с маркировкой.

VCCI Class B ITE

この装置は、情報処理装置等電波障害自主規制協議会（VCCI）の基準に基づくクラスB情報技術装置です。この装置は、家庭環境で使用することを目的としていますが、この装置がラジオやテレビジョン受信機に近接して使用されると、受信障害を引き起こすことがあります。
取扱説明書に従って正しい取り扱いをして下さい。

Korean Class B ITE

B급 기기
(가정용 방송통신기기)

이 기기는 가정용(B급)으로 전자파적합등록을 한 기기로서 주로 가정에서 사용하는 것을 목적으로 하며, 모든 지역에서 사용할 수 있습니다.

China RoHS

Product Disclosure Table
KODAK Digital Picture Frames
有毒有害物质或元素名称及含量标识表
 table of hazardous substances' name and concentration

部件名称 Component name	有毒有害物质或元素 hazardous substances' name					
	铅 (Pb)	汞 (Hg)	镉 (Cd)	六价铬 (Cr6+)	多溴联苯 (PBB)	多溴二苯醚 (PBDE)
交流变压器电路板元件 AC Adapter circuit board components	x	o	o	o	o	o
数码相架电路板元件 Digital Photo Frame circuit board components	x	o	o	o	o	o
数码相架外壳 Digital Photo Frame Enclosure	o	o	o	o	o	o

○：表示该有毒有害物质在该部件所有均质材料中的含量均在SJ/T 11363-2006规定的限量要求以下。
 ×：表示该有毒有害物质至少在该部件的某一均质材料中的含量超出SJ/T 11363-2006规定的限量要求。
 ○： indicates hazardous substance concentration lower than MCV
 ×： indicates hazardous substance concentration higher than MCV

Index

A

- about, frame, 31
- AC adapter, 2, 40
- appendix, 39
- attaching
 - different standard frame, 24
 - faceplate, included, 9
 - power cable, 2
 - stand, 1
- automatic
 - on/off, setting, 7
 - resizing during copy, 30

B

- border, touch, 4
- brightness, 30
- button, mode, i, 12

C

- cable
 - power, connecting, 2
 - USB, connecting, 8
- calendar, viewing mode, 12
- card, memory
 - inserting, 8
 - slot, i
 - supported types, 39
- changing picture locations, 11
- cleaning frame, 33, 41
- clock and timer, setting, 6, 36
- clock, viewing mode, 12
- collage mode, 13

copying

- automatic resizing, 19, 30
- from computer, camera, 19
- to frame's internal memory, 19

D

- default play location, saving, 15
- delete pictures, 20
- display picture order by, 31
- display pictures, fit/fill, 31
- disposal, recycling, 41
- download, EASYSHARE Digital Display Software, 21
- duration, picture display, 29

E

- EASYSHARE Digital Display Software
 - create slide show, 21
 - download, install, 21
- error messages, 37

F

- faceplate, attaching, 9
- file formats, pictures, 39
- firmware, upgrading, 29, 32, 40
- fit or fill display, 31
- flash drive, connecting, 8
- format cards, FAT16 or 32, 35
- frame, picture
 - hanging on wall, 28
 - resetting, 35
 - setup, 1

- specifications, 39
- troubleshooting, 34
- turn on/off, 3

freeze or lock screen, reset, 35

G

go-to play location, 15

H

help

- frame, 34
- support URLs, 33
- troubleshooting and support, 34

I

installing

- EASYSHARE Digital Display Software, 21
- included faceplate, 9
- memory cards, 8
- standard picture frame, 24

internal memory

- capacity, 39
- copying to, 19

K

KODAK PERFECT TOUCH
Technology, 31

L

landscape, set orientation, 23

language, setting, 6

locked screen, reset, 35

M

memory card. See card, memory

menu selections, 16

- copy, 19
- delete, 20
- multi-select, 18
- pictures, 11
- select all/deselect all, 18
- settings, 29
- slide show, 22
- thumbnails, 14

mode

- button, i
- changing, 12

most recent week, play, 30

multimedia slide show, 21

O

order, display by, 31

order, picture display, 11

orientation setting, 23, 30

P

pictures

- copying to internal memory, 19
- deleting, 20
- display order, 11
- location, viewing, 11
- selecting more than one, 18
- thumbnails, 14
- viewing single, 15

pictures menu, 11, 16

play location, default, 15

portrait, set orientation, 23

power
 button, i, 3
 connecting, 2
 specifications, 39

Q
quick touch border, 4

R
recycling, disposal, 41
regulatory compliance, 43
reset frame, 35

S
safety information, 40
screen
 cleaning, 33, 41
 error messages, 37
selecting
 menus and pictures, 4
 multiple pictures, 18
setting
 auto on/off, 7
 clock after losing power, 36
settings, 29
 about this frame, 31
 automatic resizing, 30
 brightness, 30
 clock and timer, 6
 display picture order by, 31
 duration, 29
 firmware upgrade, 32
 fit/fill, 31
 frame orientation, 23
 KODAK PERFECT TOUCH, 31

 language, 6
 shuffle, 30
 slide show starting point, 30
 transition, 29
 upgrade firmware, 29
 setup, picture frame, 1
 shuffle, 11, 30
 single picture, 15
 slide duration, setting, 29
 slide show
 create, 21
 starting point, 30
 slide to select, 5
 software, upgrading, 40
 source, picture location, 11
 specifications, frame, 39
 stand, attaching, 1
 stand, changing position, 23
 standard picture frame, adding, 24
 storage capacity, internal memory, 39

T
 tap to select, 5
 thumb drive. See flash drive.
 thumbnails, 14
 timer, auto on/off, 7
 transition, setting, 29
 troubleshooting
 error messages, 37
 frame, 34
 turn on frame, 3

U
upgrading

- firmware, 29
 - software and firmware, 40
- USB device, connecting, 8

V

- viewing
 - modes, changing, 12
 - picture sources, 11
 - single picture, 15
 - thumbnails, 14
- viewing mode button, i

W

- wall mount, frame, 28
- warranty, 41
- Web sites, help, 33