

325D L

Hydraulic Excavator



Engine

Engine Model	Cat [®] C7 with ACERT™ Technology	
Net Flywheel Power	152 kW	204 hp

Weights

Operating Weight –	29 240 kg	64,460 lb
Long Undercarriage		

- Reach boom, R3.2CB2 (10 ft 5 in) Stick, 1.1 m³ (1.44 yd³) Bucket, 800 mm (32 in) Shoes

325D L Hydraulic Excavator

The D Series incorporates innovations for improved performance and versatility.

C7 with ACERT™ Technology

- ✓ ACERT™ Technology works at the point of combustion to optimize engine performance and provide low exhaust emissions to meet U.S. EPA Tier 3 emission regulations, with exceptional performance capabilities and proven reliability. **pg. 4**

Versatility

Caterpillar offers a wide variety of factory-installed attachments that enhance performance and job site management. **pg. 11**

Hydraulics

The hydraulic system has been designed to provide reliability and outstanding controllability. An optional Tool Control System provides enhanced flexibility. **pg. 5**

Service and Maintenance

Fast, easy service has been designed in with extended service intervals, advanced filtration, convenient filter access and user-friendly electronic diagnostics for increased productivity and reduced maintenance costs. **pg. 12**

Operator Comfort

- ✓ Provides maximum space, wider visibility and easy access to switches. The monitor is a full-color graphical display that allows the operator to understand the machine information easily. Overall, the new cab provides a comfortable environment for the operator. **pg. 6**



Structures

Caterpillar® design and manufacturing techniques assure outstanding durability and service life from these important components. Three length of booms and five sticks are available to suit a variety of application conditions. **pg. 8**

Booms, Sticks and Bucket Attachments

Designed for maximum flexibility, productivity and high efficiency on all jobs, the 325D offers a wide range of configurations suitable for a variety of applications. **pg. 9**

Work Tools – Attachments

- ✓ A variety of work tools, including buckets, couplers, hammers, and shears are available through Cat Work Tools. **pg. 10**

Complete Customer Support

Your Cat® dealer offers a wide range of services that can be set up under a customer support agreement when you purchase your equipment. The dealer will help you choose a plan that can cover everything from machine configuration to eventual replacement. **pg. 13**



✓ *New Feature*

C7 with ACERT™ Technology

Built for power reliability, economy and low emissions.

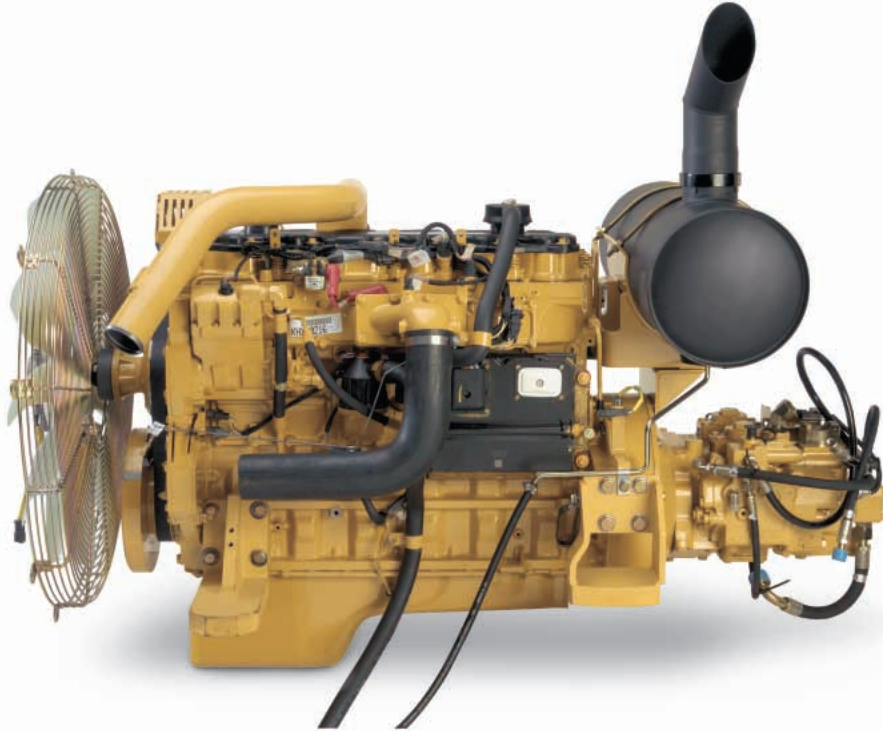

Cat C7. The Cat C7 with ACERT™ Technology introduces a series of evolutionary, incremental improvements that provide breakthrough engine technology. The building blocks of ACERT Technology are fuel delivery, air management and electronic control. ACERT Technology optimizes engine performance while meeting U.S. EPA Tier 3 engine emission regulations.

Performance. The 325D L, equipped with the C7 engine with ACERT Technology, provides 12% more horsepower as compared to the 3126B ATAAC HEUI in the 325C L.

Automatic Engine Speed Control.

The two-stage, one-touch control maximizes fuel efficiency and reduces sound levels.

ADEM™ A4 Engine Controller.

The ADEM A4 electronic control module manages fuel delivery to get the best performance per liter of fuel used. The engine management system provides flexible fuel mapping, allowing the engine to respond quickly to varying application needs. It tracks engine and machine conditions while keeping the engine operating at peak efficiency.

Electronic Control Module.

The Electronic Control Module (ECM) works as the “brain” of the engine’s control system, responding quickly to operating variables to maximize engine efficiency. Fully integrated with sensors in the engine’s fuel, air, coolant, and exhaust systems, the ECM stores and relays information on conditions such as rpm, fuel consumption, and diagnostic information.

Fuel Delivery. The Cat C7 features electronic controls that govern the fuel injection system. Multiple injection fuel delivery involves a high degree of precision. Precisely shaping the combustion cycle lowers combustion chamber temperatures, generating fewer emissions and optimizing fuel combustion. This translates into more work output for your fuel cost.

Cooling System. The cooling fan is directly driven from the engine. An electrically controlled viscous clutch fan is available as an attachment to reduce fan noise. The optimum fan speed is calculated based on the target engine speed, coolant temperature, hydraulic oil temperature and actual fan speed. The Cat C7 delivered a completely new layout that separates the cooling system from the engine compartment.

Air Cleaner. The radial seal air filter features a double-layered filter core for more efficient filtration and is located in a compartment behind the cab. A warning is displayed on the monitor when dust accumulates above a preset level.

Noise Reduction Technologies.

The engine mounts are rubber-isolating mounts matched with the engine package. Further noise reduction has been achieved through design changes to the isolated top cover, oil pan, multiple injection strategy, insulated timing cover, sculpted crankcase and gear train refinements.

Hydraulics

Cat® hydraulics deliver power and precise control to keep material moving.

Component Layout. The hydraulic system and component locations have been designed to provide a high level of system efficiency. The main pumps, control valves and hydraulic tank are located close together to allow for shorter tubes and lines between components which reduces friction loss and pressure drops in the lines. The layout further provides greater operator comfort by placing the radiator on the cab side of the upper structure. This allows incoming air to enter the engine compartment from the operator side and hot air and corresponding engine sound to exit on the opposite side away from the operator. This reduces engine compartment heat and sound being transmitted to the operator.

Pilot System. The pilot pump is independent from the main pumps and controls the front linkage, swing and travel operations.

Hydraulic Cross Sensing System. The hydraulic cross sensing system utilizes each of two hydraulic pumps to 100 percent of engine power, under all operating conditions. This improves productivity with faster implement speeds and quicker, stronger pivot turns.

Boom and Stick Regeneration Circuit. Boom and stick regeneration circuit saves energy during boom-down and stick-in operation which increases efficiency, reduces cycle times and pressure loss for higher productivity, lower operating costs and increased fuel efficiency.



Auxiliary Hydraulic Valve. The auxiliary valve is standard on the 325D. Control Circuits are available as attachments, allowing for operation of high and medium pressure tools such as shears, grapples, hammers, pulverizers, multi-processors and vibratory plate compactors.

Hydraulic Cylinder Snubbers. Snubbers are located at the rod-end of the boom cylinders and both ends of the stick cylinders to cushion shocks while reducing sound levels and extending component life.

Operator Comfort

Designed for comfort, simple and easy operation, the 325D allows the operator to focus on production.



Operator Station. The workstation is spacious, quiet and comfortable, assuring high productivity during a long work day. The air conditioner and attachment switches are conveniently located on the right-hand wall, and the key switch and throttle dial are on the right-hand console.



Monitor. The monitor is a full color 400 × 234 pixels Liquid Crystal Display (LCD) graphic display. The monitor angle can be adjusted to minimize sun glare and has the capability of displaying information in twenty-seven different languages.

Pre-Start Check. Prior to starting the machine, the system will check for low fluid levels for the engine oil, hydraulic oil and engine coolant and warn the operator through the monitor in the event display area.

Gage Display. Three analog gauges, fuel level, hydraulic oil temperature and coolant temperature, are displayed in this area.

Event Display. Machine information is displayed in this area with the icon and language.

Multi-information Display. This area is reserved for displaying various information which is convenient for the operator. The “CAT” mark is displayed when no information is available to be displayed.

Standard Cab Equipment. To enhance operator comfort and productivity, the cab includes a lighter, drink holder, coat hook, service meter, literature holder, magazine rack and storage compartment.

Seat. A new optional air suspension seat is available in the 325D. The standard and optional seats provide a variety of adjustments to suit the operator’s size and weight including fore/aft, height and weight. Wide adjustable armrests and a retractable seat belt are also included.

Joystick Control. Joystick controls have low lever effort and are designed to match the operator’s natural wrist and arm position. The operator can operate joystick controls with an arm on the armrest and the horizontal and vertical strokes have been designed to reduce operator fatigue.

Hydraulic Activation Control Lever. For added safety, this lever must be in the operate position to activate the machine control functions.

Automatic Climate Control. Fully automatic climate control adjusts temperature and flow, and determines which air outlet is best in each situation with a touch of a button.



Console. Redesigned consoles feature a simple, functional design to reduce operator fatigue, ease of switch operation and excellent visibility. Both consoles have attached armrests with height adjustments.

Cab Exterior. The exterior design uses thick steel tubing along the bottom perimeter of the cab, improving the resistance of fatigue and vibration. This design allows the FOGS to be bolted directly to the cab, at the factory or as an attachment later, enabling the machine to meet specifications and job site requirements.

Cab Mounts. The cab shell is attached to the frame with viscous rubber cab mounts, which dampen vibrations and sound levels while enhancing operator comfort.

Windows. All glass is affixed directly to the cab for excellent visibility eliminating window frames. The upper front windshield opens, closes and stores on the roof above the operator with a one-touch action release system.

Wipers. Pillar-mounted wipers increase the operator’s viewing area and offer continuous and intermittent modes.

Skylight. An enlarged skylight with sunshade provides excellent visibility and ventilation.

Structures

325D structural components and undercarriage are the backbone of the machine's durability.

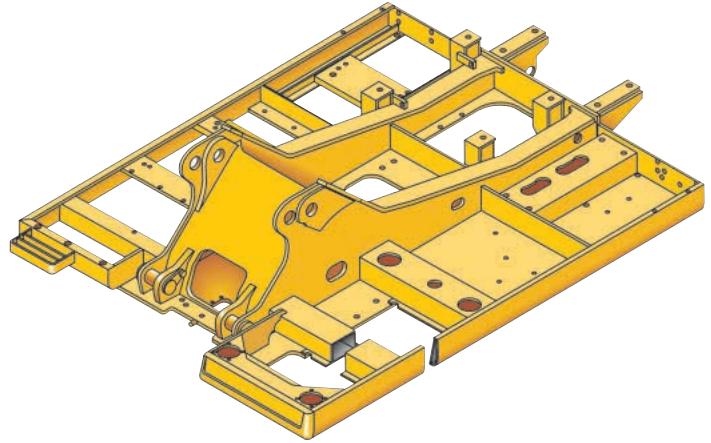
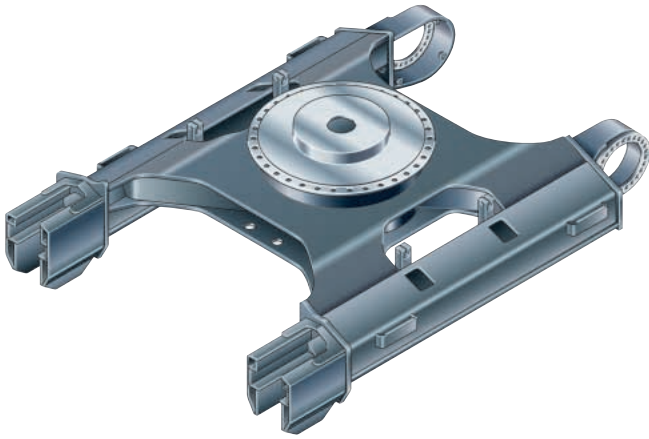

Robotic Welding. Up to 95% of the structural welds on a Caterpillar® Excavator are completed by robots. Robotic welds achieve over three times the penetration of manual welds.

Carbody Design and Track Roller Frames. X-shaped, box-section carbody provides excellent resistance to torsional bending. Robot-welded track roller frames are press-formed, pentagonal units to deliver exceptional strength and service life.

Main Frame. Rugged main frame is designed for maximum durability and efficient use of materials.

Undercarriage. Durable Cat® undercarriage absorbs stresses and provides excellent stability.

Swing Bearing. The swing bearing utilizes cross roller bearings versus the traditional ball bearing design. The cross roller bearing design allows for more surface contact to absorb the stresses that are a result of the high swing torque that Cat offers. It provides exceptional machine stability and reduces machine pitching during boom down operation.

Rollers and Idlers. Sealed and lubricated track rollers, carrier rollers, and idlers provide excellent service life, to keep the machine in the field longer.

Long Undercarriage. The long (L) undercarriage maximizes stability and lift capacity. Two additional track links have been added to the 325D L. This long, wide, and sturdy undercarriage offers a very stable work platform.

Booms, Sticks and Bucket Attachments

Designed for maximum flexibility, productivity and high efficiency on all jobs, the 325D offers a wide range of configurations suitable for a variety of applications.

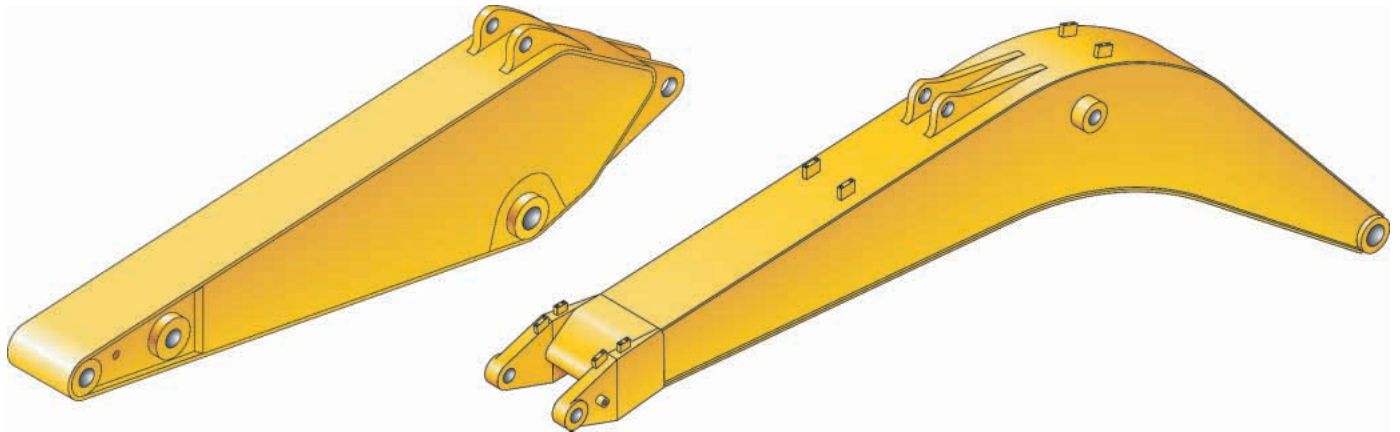

Reach Boom. The reach boom features an optimum design that maximizes digging envelopes with three stick choices:

R3.75CB and R3.2CB Sticks.

The CB-family buckets associated with these sticks have enough capacity for excellent reach and depth in trenching and general construction applications.

R2.65CB Stick. Stick is suited to high-capacity buckets used in trenching, excavation, and other general construction work. It has been designed with enough reach and depth to match a large-capacity bucket and high digging force.

Mass Excavation Boom. The mass excavation boom maximizes productivity. The mass version offers significantly higher digging forces and allows use of larger buckets.

M3.2CB Stick. This stick gives the largest working envelope with the Mass Boom and CB-Family Buckets.

M2.5DB. The DB Stick uses a D-family bucket and was designed for high volume earth moving, powerful digging force and a large capacity bucket. Combined with a Mass boom, this stick delivers outstanding productivity.

Super Long Reach. This configuration offers reaches to over 8.3 m (60 feet). It is well suited for ditch cleaning applications.

Linkage Pins. The bucket linkage pins have been enlarged to improve reliability and durability. All the pins in the front linkages have thick chrome plating, giving them high wear and corrosion resistance.

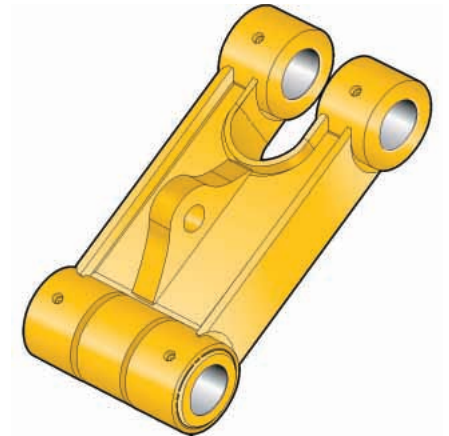

Bucket Linkage. The power link improves durability, increases machine-lifting capability in key lifting positions and with the integrated lift-eye it is easier to use than compared to the previous power link.

Work Tools – Attachments

The 325D has an extensive selection of work tools to optimize machine performance.



Heavy Duty Buckets. Heavy-duty (HD) buckets are used for a wide range of moderately abrasive applications such as mixed dirt, clay and rock. HD buckets have best loading and dumping characteristics and will empty easier in cohesive material. More robust construction than the GP buckets.

General Purpose Capacity (GP-C) Buckets. General Purpose Capacity Buckets are best for digging in soft to hard ground with low to moderately abrasive materials.

Heavy-Duty Power (HDP) Buckets. For use in moderately abrasive applications where breakout force and cycle times are critical. Maximizes tip force and improves cycle times in most materials.

Heavy Duty Rock Buckets. Heavy-duty rock for aggressive bucket loading in highly abrasive application such as shot rock and granite. Features include:

- Thicker wear plates to extend the life of bucket in severe applications
- Side wear plated extend further up the side of the bucket for maximum protection in rocky soils
- Buckets accept sidebar protectors for best sidebar protection, or side cutters for best fill characteristics and bucket wear protection

Ditch Cleaning (DC) Buckets.

These wide shallow buckets are best for bank forming, ditch cleaning, and finishing.

Caterpillar Ground Engaging Tools (GET).

All bucket in the CB/DB Family utilize the Caterpillar K Series® GET. This GET system uses a vertical retainer that is easier to remove and install than the Cat J Series pin. The tip shapes are more aggressive and offer better penetration than the previous generation of tips. There are also a variety of side cutters and sidebar protectors to match operating conditions.



Vibratory Plate Compactor

Caterpillar® Vibratory Plate Compactors provide superior compaction force in a reliable, low-maintenance package. These units produce high-power impulses at a rate of 2,200 impacts per minute. The forces generated by this vibration drive soil particles close together for solid, stable compactions. Whether in a trench or on a slope, driving sheeting or posts, Cat Compactors are the superior choice for any job site's compaction tasks.



Multi-processor

Multi-processors do the work of many types of demolition tools by use of interchangeable jaw sets. Changing jaws allows a single unit to crush, pulverize and perform a variety of specialized cutting tasks, such as cutting steel rebar and tanks.

Versatility

A wide variety of optional factory-installed attachments to enhance performance and improve job site management.



Tool Control System. This system offers the most flexibility and versatility of the auxiliary options offered. This system is available in two configurations, as a stand-alone system or with a medium pressure circuit and third pump. This system is capable of running either one-way or two-way tools and one one-pump or two pump tools. The additional of the medium pressure circuit allows use of tools that rotate such as grapples, shears or multi-processors. Up to 10 different tool settings can be pre-programmed and selected through the monitor.

Auxiliary Hydraulics Options. There are four different options that can be factory installed to meet the various demands for hydra-mechanical tools. Single-Function, Double-Function, Tool Control System without Medium Pressure and Tool Control System with Medium Pressure are available as a factory installed option.

Single-Function Auxiliary Hydraulics.

This circuit utilizes one-way flow action with two pumps and can run tools such as hammers and vibratory plate compactors.

Double-Function Auxiliary Hydraulics.

This circuit utilizes two-way flow and one pump and is capable of running tools such as a thumb, tilt-bucket or non-rotating grapples or shears.



Machine Security. An optional Machine Security System is available from the factory on the 325D L. This system controls when the machine can be operated and utilizes specific keys to prevent unauthorized machine use, a significant theft deterrent.

Product Link. The machine is pre-wired to accept Product Link systems to be installed in the field. Product Link is also available as a factory installed attachment. Product Link can assist with Fleet Management that will keep track of hours, location, security and product health.



Pin Grabber Plus Hydraulic Pin Grabber

Increases versatility of the excavator by allowing the machine to pick up a wide variety of work tools without leaving the cab.



Sorting Grapple

Caterpillar Grapples replace the bucket on Caterpillar Excavators, converting them to the ideal machine for handling loose material, sorting trash and demolition site cleanup. An array of styles and sizes are available to match the task at hand.

Service and Maintenance

Simplified service and maintenance features save you time and money.



Ground Level Service. The design and layout was made with the service technician in mind. Many service locations are easily accessible at ground level allowing critical maintenance to get done quickly and efficiently.

Air Filter Compartment. The air filter features a double-element construction for superior cleaning efficiency. When the air cleaner plugs, a warning is displayed on the monitor screen inside the cab.

Pump Compartment. A service door on the right side of the upper structure allows ground-level access to the pump and pilot filter.

Radiator Compartment. The left rear service door allows easy access to the engine radiator, oil cooler and air-to-air-after-cooler. A reserve tank and drain cock are attached to the radiator for simplified maintenance.

Capsule Filter. The hydraulic return filter, a capsule filter, is situated outside the hydraulic tank. This filter prevents contaminants from entering the system when hydraulic oil is changed and keeps the operation clean.



Greasing Points. A concentrated remote greasing block on the boom delivers grease to hard-to-reach locations on the front.

Fan Guard. Engine radiator fan is completely enclosed by fine wire mesh, reducing the risk of an accident.

Anti-Skid Plate. Anti-skid plate covers top of storage box and upper structure to prevent slipping during maintenance.



Diagnostics and Monitoring. The 325D is equipped with S•O•SSM sampling ports and hydraulic test ports for the hydraulic system, engine oil, and for coolant. A test connection for the Cat Electronic Technician (Cat ET) service tool is located in the cab.

Extended Service Interval. 325D service and maintenance intervals have been extended to reduce machine service time and increase machine availability.

Complete Customer Support

Cat® dealer services help you operate longer with lower costs.



Product Support. You will find nearly all parts at our dealer parts counter. Cat dealers utilize a worldwide computer network to find in-stock parts to minimize machine down time. Save money with remanufactured components.

Machine Selection. Make detailed comparisons of the machines you are considering before you buy. What are the job requirements, machine attachments and operating hours? What production is needed? Your Cat dealer can provide recommendations.

Customer Support Agreements.

Cat dealers offer a variety of product support agreements, and work with customers to develop a plan the best meets specific needs. These plans can cover the entire machine, including attachments, to help protect the customer's investment.

Operation. Improving operating techniques can boost your profits. Your Cat dealer has videotapes, literature and other ideas to help you increase productivity, and Caterpillar offers certified operator training classes to help maximize the return on your investment.

Maintenance Services. Repair option programs guarantee the cost of repairs up front. Diagnostic programs such as Scheduled Oil Sampling, Coolant Sampling and Technical Analysis help you avoid unscheduled repairs.

Replacement. Repair, rebuild, or replace? Your Cat dealer can help you evaluate the cost involved so you can make the right choice.

Engine

Engine Model	Cat® C7 with ACERT™ Technology	
Net Flywheel Power	152 kW	204 hp
Net Power – ISO 9249	152 kW	204 hp
Net Power – SAE J1349	151 kW	202 hp
Net Power – EEC 80/1269	152 kW	204 hp
Bore	110 mm	4.3 in
Stroke	127 mm	5 in
Displacement	7.2 L	440 in ³

- The 325D L meets U.S. EPA Tier 3 emissions and EU Stage III engine emissions requirements.
- Net power advertised is the power available at the flywheel when the engine is equipped with fan, air cleaner, muffler and alternator.
- No engine derating needed up to 2300 m (7,500 ft).

Weights

Operating Weight	29 240 kg	64,460 lb
------------------	-----------	-----------

- Reach boom, R3.2CB2 (10 ft 5 in) Stick, 1.1 m³ (1.44 yd³) Bucket, 800 mm (32 in) Shoes.

Track

Standard w/Long Undercarriage	800 mm	32 in
Optional	600 mm	24 in
Optional	700 mm	28 in
Optional	800 mm	32 in
Number of Shoes Each Side	50	
Number of Track Rollers Each Side	9	
Number of Carrier Rollers Each Side	2	

Swing Mechanism

Swing Speed	10.2 rpm	
Swing Torque	82.2 kN·m	60,628 lb ft

Service Refill Capacities

Fuel Tank Capacity	520 L	137 gal
Cooling System	30 L	7.9 gal
Engine Oil	30 L	7.9 gal
Swing Drive	10 L	2.6 gal
Final Drive (each)	6 L	1.6 gal
Hydraulic System (including tank)	310 L	82 gal
Hydraulic Tank	145 L	38 gal

Drive

Maximum Drawbar Pull	249 kN	55,977 lb
Maximum Travel Speed	5.3 km/h	3.3 mph

Hydraulic System

Main Implement System – Maximum Flow (2x)	235 L/min	62 gal/min
Max. pressure – Equipment	35 000 kPa	5,076 psi
Max. pressure – Equipment – Heavy	36 000 kPa	5,221 psi
Max. pressure – Travel	35 000 kPa	5,076 psi
Max. pressure – Swing	27 500 kPa	3,989 psi
Pilot System – Maximum flow	32.4 L/min	8.6 gal/min
Pilot System – Maximum pressure	3900 kPa	566 psi
Boom Cylinder – Bore	140 mm	5.5 in
Boom Cylinder – Stroke	1407 mm	55.4 in
Stick Cylinder – Bore	150 mm	5.9 in
Stick Cylinder – Stroke	1646 mm	64.8 in
CB2 Family Bucket Cylinder – Bore	135 mm	5.3 in
CB2 Family Bucket Cylinder – Stroke	1156 mm	46 in
DB Family Bucket Cylinder – Bore	150 mm	5.9 in
DB Family Bucket Cylinder – Stroke	1156 mm	46 in

Sound Performance

Performance	ANSI/SAE
-------------	----------

- When properly installed and maintained, the cab offered by Caterpillar, when tested with doors and windows closed according to ANSI/SAE J1166 OCT 98, meets OSHA and MSHA requirements for operator sound exposure limits in effect at time of manufacture.
- Hearing protection may be needed when operating with an open operator station and cab (when not properly maintained or doors/windows open) for extended periods or in noisy environment.

Standards

Brakes	SAE J1026 APR90
Cab/FOGS	SAE J1356 FEB88 ISO 10262

Dimensions

All dimensions are approximate.

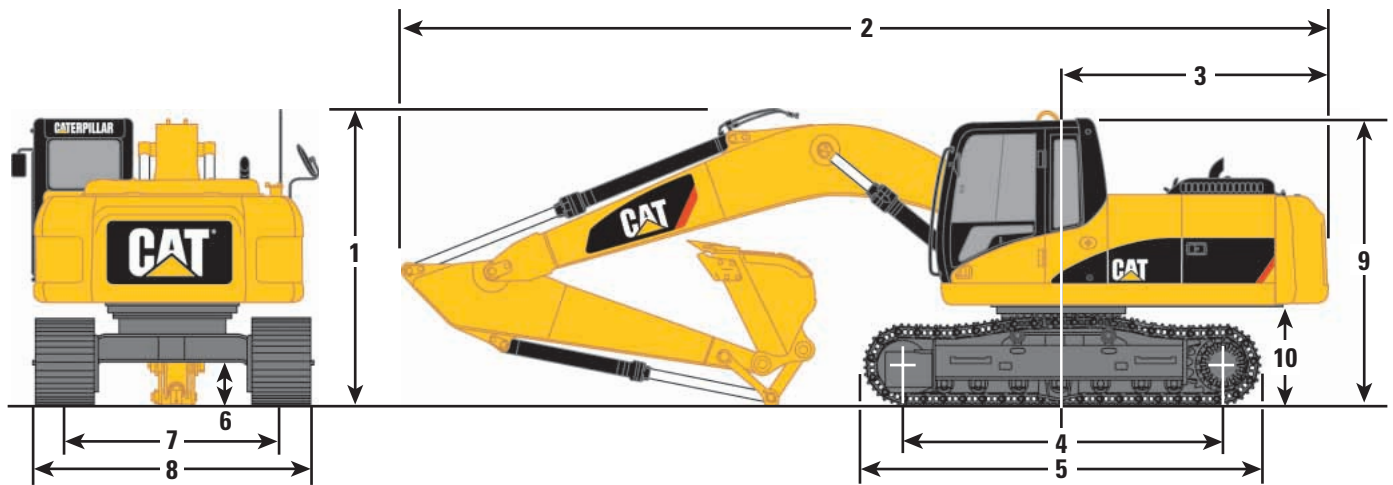

Boom Options	Reach Boom 6.15 m (20'2")			Mass Boom 5.55 m (18'2")	
Stick Options	R3.75CB2 (12'4")	R3.2CB2 (10'6")	R2.65CB2 (8'8")	M3.2CB2 (10'6")	M2.5DB (8'2")
1 Shipping height	3632 mm (11'11")	3180 mm (10'5")	3190 mm (10'6")	3130 mm (10'3")	3250 mm (10'8")
2 Shipping length	10 410 mm (34'2")	10 410 mm (34'2")	10 420 mm (34'2")	9800 mm (32'2")	9860 mm (32'4")
3 Tail swing radius	3080 mm (10'1")	3080 mm (10'1")	3080 mm (10'1")	3080 mm (10'1")	3080 mm (10'1")
Undercarriage					
4 Length to center of rollers	3990 mm (13'1")	3990 mm (13'1")	3990 mm (13'1")	3990 mm (13'1")	3990 mm (13'1")
5 Track length	4860 mm (15'11")	4860 mm (15'11")	4860 mm (15'11")	4860 mm (15'11")	4860 mm (15'11")
6 Ground clearance	490 mm (1'7")	490 mm (1'7")	490 mm (1'7")	490 mm (1'7")	490 mm (1'7")
7 Track gauge	2590 mm (8'6")	2590 mm (8'6")	2590 mm (8'6")	2590 mm (8'6")	2590 mm (8'6")
8 Transport width					
800 mm (32") shoes (standard)	3390 mm (11'1")	3390 mm (11'1")	3390 mm (11'1")	3390 mm (11'1")	3390 mm (11'1")
700 mm (28") shoes (optional)	3290 mm (10'10")	3290 mm (10'10")	3290 mm (10'10")	3290 mm (10'10")	3290 mm (10'10")
600 mm (24") shoes (optional)	3190 mm (10'6")	3190 mm (10'6")	3190 mm (10'6")	3190 mm (10'6")	3190 mm (10'6")
9 Cab height	3040 mm (10'0")	3040 mm (10'0")	3040 mm (10'0")	3040 mm (10'0")	3040 mm (10'0")
10 Counterweight clearance	1110 mm (3'8")	1110 mm (3'8")	1110 mm (3'8")	1110 mm (3'8")	1110 mm (3'8")

Reach Excavator Working Ranges

Reach (R) boom configuration

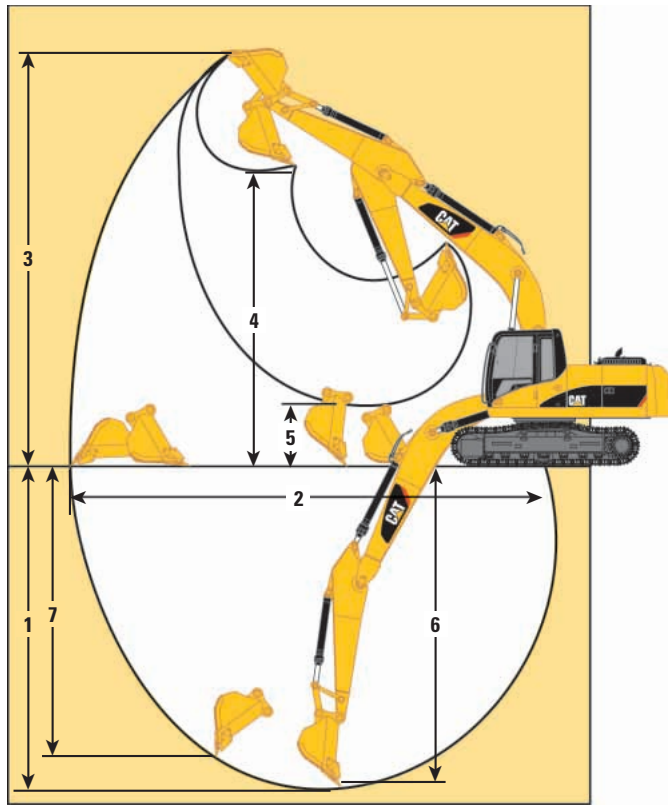

Mass Excavator Working Ranges

Mass (M) boom configuration

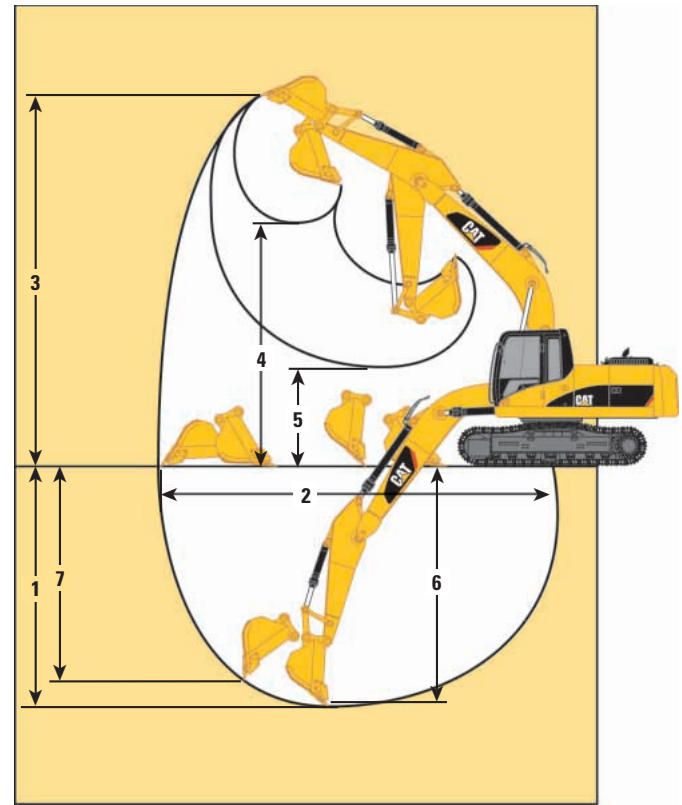

Boom Options	Reach Boom 6.15 m (20'2")				Mass Boom 5.55 m (18'2")		
Stick Options	R3.75CB2 (12'4")	R3.2CB2 (10'6")	R2.65CB2 (8'8")	R3.2CB2 (10'6")	R2.65CB2 (8'8")	M3.2CB2 (10'6")	M2.5DB (8'2")
Bucket Options	HD 1.35 m ³ (1.77 yd ³)	HD 1.35 m ³ (1.77 yd ³)	HD 1.35 m ³ (1.77 yd ³)	HD 1.35 m ³ (1.77 yd ³) with Pin Grabber Coupler	HD 1.35 m ³ (1.77 yd ³) with Pin Grabber Coupler	HD 1.57 m ³ (2.05 yd ³)	HD 1.87 m ³ (2.45 yd ³)
1 Maximum digging depth	7833 mm (25'8")	7283 mm (23'11")	6733 mm (22'1")	7571 mm (24'10")	7020 mm (23'0")	6738 mm (22'1")	6130 mm (20'1")
2 Maximum reach at ground level	11 153 mm (36'7")	10 656 mm (35'0")	10 176 mm (33'5")	10 986 mm (36'1")	10 507 mm (34'6")	10 023 mm (32'11")	9453 mm (31'0")
3 Maximum cutting height	10 297 mm (33'9")	10 115 mm (33'2")	10 000 mm (32'10")	10 256 mm (33'8")	10 156 mm (33'4")	9686 mm (31'9")	9227 mm (30'3")
4 Maximum loading height	7102 mm (23'4")	6908 mm (22'8")	6762 mm (22'2")	6620 mm (21'9")	6475 mm (21'3")	6480 mm (21'3")	5968 mm (19'7")
5 Minimum loading height	1707 mm (5'7")	2257 mm (7'5")	2807 mm (9'3")	1969 mm (6'6")	2519 mm (8'3")	1833 mm (6'0")	2441 mm (8'0")
6 Maximum depth cut for 2440 mm (8') level bottom	7694 mm (25'3")	7128 mm (23'5")	6558 mm (21'6")	7425 mm (24'4")	6857 mm (22'6")	6583 mm (21'7")	5942 mm (19'6")
7 Maximum vertical wall digging depth	6590 mm (21'7")	6143 mm (20'2")	5811 mm (19'1")	4553 mm (14'11")	4325 mm (14'2")	5611 mm (18'5")	5051 mm (16'7")

Dimensions

All dimensions are approximate.

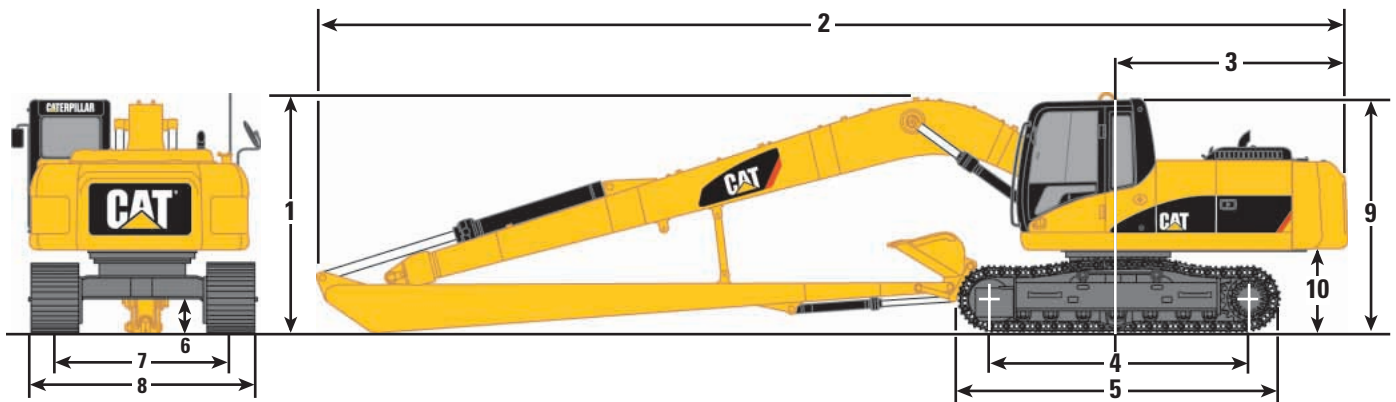

Boom Options

Super Long Reach Boom

10.2 m (33'6")

Stick Options

7.85 m (25'9")

1	Shipping height	3230 mm (10'7")
2	Shipping length	14 380 mm (47'2")
3	Tail swing radius	3080 mm (10'1")
4	Length to center of rollers	3990 mm (13'1")
5	Track length	4860 mm (15'11")
6	Ground clearance	490 mm (1'7")
7	Track gauge	2590 mm (8'6")
8	Transport width	
	800 mm (32") shoes (standard)	3390 mm (11'1")
	700 mm (28") shoes (optional)	3290 mm (10'10")
	600 mm (24") shoes (optional)	3190 mm (10'6")
9	Cab height	3040 mm (10'0")
10	Counterweight clearance	1110 mm (3'8")

Reach Excavator Working Ranges

Reach (R) boom configuration

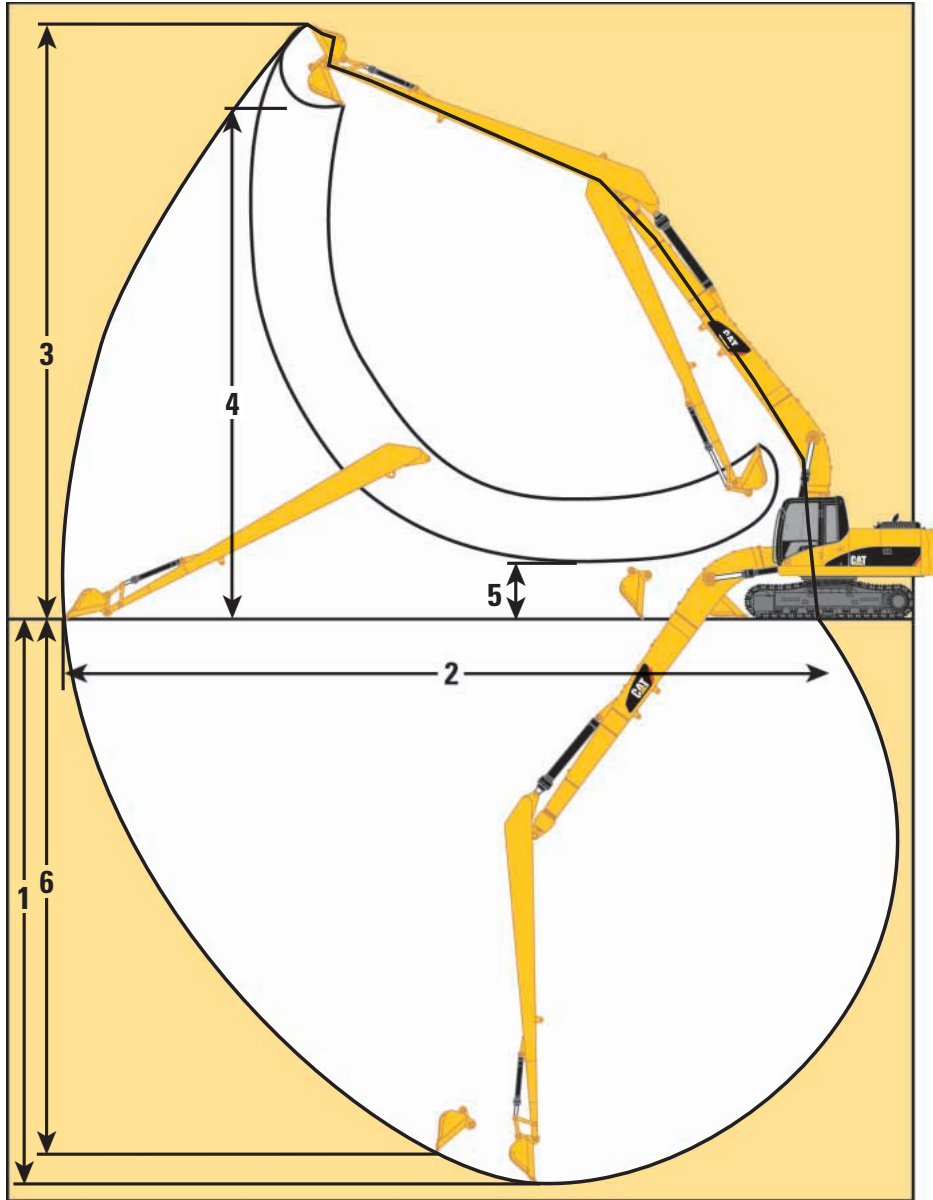

Boom Options

Super Long Reach Boom
10.2 m (33'6")

Stick Options

7.85 m (25'9")

Bucket Options

DC 0.61 m³ (0.8 yd³)

1	Maximum digging depth	14 620 mm (48'0")
2	Maximum reach at ground level	18 600 mm (61'0")
3	Maximum cutting height	14 842 mm (48'8")
4	Maximum loading height	12 735 mm (41'9")
5	Minimum loading height	1483 mm (4'10")
6	Maximum vertical wall digging depth	13 986 mm (45'11")

Bucket and Stick Forces

Stick Options	R3.75CB2	R3.2CB2	R3.2CB2 with Pin Grabber Coupler	R2.65CB2	R2.65CB2 with Pin Grabber Coupler	M3.2CB2	M2.5DB
Power Buckets							
Bucket Digging Force (ISO)	201 kN (45,187 lb)	200 kN (44,962 lb)	162 kN (36,419 lb)	201 kN (45,187 lb)	162 kN (36,419 lb)	200 kN (44,962 lb)	239 kN (53,729 lb)
Stick Digging Force (ISO)	120 kN (26,977 lb)	133 kN (29,900 lb)	125 kN (28,101 lb)	152 kN (34,171 lb)	142 kN (31,923 lb)	133 kN (29,900 lb)	162 kN (36,419 lb)
Bucket Digging Force (SAE)	176 kN (39,566 lb)	176 kN (39,566 lb)	157 kN (35,295 lb)	176 kN (39,566 lb)	157 kN (35,295 lb)	176 kN (39,566 lb)	209 kN (46,985 lb)
Stick Digging Force (SAE)	117 kN (26,303 lb)	129 kN (29,000 lb)	124 kN (27,876 lb)	147 kN (33,047 lb)	141 kN (31,698 lb)	129 kN (29,000 lb)	156 kN (35,070 lb)
HD and HDR Buckets							
Bucket Digging Force (ISO)	179 kN (40,241 lb)	179 kN (40,241 lb)	155 kN (34,845 lb)	180 kN (40,466 lb)	155 kN (34,845 lb)	179 kN (40,241 lb)	215 kN (48,334 lb)
Stick Digging Force (ISO)	118 kN (26,527 lb)	130 kN (29,225 lb)	123 kN (27,651 lb)	149 kN (33,497 lb)	139 kN (31,248 lb)	130 kN (29,225 lb)	158 kN (35,520 lb)
Bucket Digging Force (SAE)	159 kN (35,745 lb)	159 kN (35,745 lb)	142 kN (31,923 lb)	159 kN (35,745 lb)	142 kN (31,923 lb)	159 kN (35,745 lb)	189 kN (42,489 lb)
Stick Digging Force (SAE)	115 kN (25,853 lb)	126 kN (28,326 lb)	120 kN (26,977 lb)	143 kN (32,148 lb)	136 kN (30,574 lb)	126 kN (28,326 lb)	152 kN (34,171 lb)

Major Component Weights*

	kg	lb
Base machine with counterweight (without front linkage)		
With 800 mm (32") shoes	24 600	54,233
Two boom cylinders (each)	550	1,213
Counterweight		
Standard counterweight	5410	11,927
Super long reach counterweight	6760	14,903
Boom (includes lines, pins and stick cylinder)		
Reach boom 6.15 m (20'2")	2300	5,071
Mass boom 5.55 m (18'2")	2375	5,236
Super long reach boom 10.2 m (33'5")	3730	8,223
Stick (includes lines, pins, bucket cylinder and linkage)		
R3.75CB2 (12'4")	1580	3,483
R3.2CB2 (10'6")	1390	3,064
R2.65CB2 (8'8")	1300	2,866
M3.2CB2 (10'6")	1530	3,373
M2.5DB (8'2")	1470	3,241
Super long reach stick 7.85 m (25'9")	1610	3,549

* All weights are approximate.

Bucket Specifications and Compatibility

Bucket Type	Adaptor	Capacity*		Width		Tip Radius		Teeth Qty	Total Weight		Reach Boom Stick			Mass Boom Stick
		m ³	yd ³	mm	in	mm	in		kg	lb	R3.75CB2	R3.2CB2	R2.65CB2	
CB Family Buckets														
General Purpose	K90	0.63	0.82	610	24	1656.3	65.2	3	729	1,606	●	●	●	●
	K90	0.86	1.12	762	30	1656.3	65.2	4	847	1,868	●	●	●	●
	K90	1.09	1.43	914	36	1656.3	65.2	5	951	2,097	●	●	●	●
	K90	1.34	1.75	1067	42	1656.3	65.2	5	1024	2,258	●	●	●	●
	K90	1.58	2.07	1219	48	1656.3	65.2	6	1121	2,471	◐	●	●	●
	K90	1.83	2.39	1372	54	1656.3	65.2	7	1218	2,684	○	◐	◐	◐
Heavy Duty	K100	0.53	0.69	610	24	1686.3	66.4	3	780	1,720	●	●	●	●
	K100	0.73	0.95	762	30	1686.3	66.4	3	858	1,891	●	●	●	●
	K100	0.93	1.22	914	36	1686.3	66.4	4	982	2,165	●	●	●	●
	K100	1.14	1.49	1067	42	1686.3	66.4	5	1073	2,365	●	●	●	●
	K100	1.35	1.77	1219	48	1686.3	66.4	5	1143	2,519	●	●	●	●
	K100	1.57	2.05	1372	54	1686.3	66.4	6	1238	2,730	◐	●	●	●
	K100	1.78	2.33	1524	60	1686.3	66.4	7	1334	2,941	○	◐	◐	◐
	K100	1.99	2.60	1676	66	1686.3	66.4	7	1406	3,101	∴	○	○	◐
Heavy Duty Rock	K100	0.73	0.95	762	30	1686.3	66.4	3	965	2,127	●	●	●	●
	K100	0.93	1.22	914	36	1686.3	66.4	4	1073	2,365	●	●	●	●
	K100	1.14	1.49	1067	42	1686.3	66.4	5	1174	2,588	●	●	●	●
	K100	1.35	1.77	1219	48	1686.3	66.4	5	1259	2,775	●	●	●	●
Heavy Duty Power	K100	1.12	1.46	1067	42	1592.1	62.7	5	1060	2,337	●	●	●	●
	K100	1.33	1.74	1219	48	1592.1	62.7	5	1137	2,507	●	●	●	●
	K100	1.53	2.00	1372	54	1592.1	62.7	6	1237	2,727	◐	●	●	●
Ditch Cleaning	N/A	1.25	1.63	1524	60	1262.0	49.7	—	739	1,629	●	●	●	●
	N/A	1.53	2.00	1830	72	1262.0	49.7	—	837	1,845	●	●	●	●

Assumptions for maximum material density rating:

1. Front linkage fully extended at ground line
2. Bucket curled
3. 100% bucket fill factor

* Based on SAE J296, some calculations of capacity specs fall on borderlines. Rounding may allow two buckets to have the same English rating, but different metric ratings.

- 2100 kg/m³ (3,500 lb/yd³) max material density
- ◐ 1800 kg/m³ (3,000 lb/yd³) max material density
- 1500 kg/m³ (2,500 lb/yd³) max material density
- ∴ 1200 kg/m³ (2,000 lb/yd³) max material density

Bucket Specifications and Compatibility

Bucket Type	Adaptor	Capacity*		Width		Tip Radius		Teeth Qty	Total Weight		Mass Boom Stick M2.5DB
		m ³	yd ³	mm	in	mm	in		kg	lb	
DB Family Buckets											
General Purpose	K100	0.94	1.23	762	30	1753.4	69.0	3	993	2,189	●
	K100	1.19	1.56	914	36	1753.4	69.0	4	1088	2,398	●
	K100	1.46	1.91	1067	42	1753.4	69.0	5	1200	2,646	●
	K100	1.73	2.26	1219	48	1753.4	69.0	5	1288	2,839	●
	K100	2.00	2.62	1372	54	1753.4	69.0	6	1401	3,089	◐
	K100	2.27	2.97	1524	60	1753.4	69.0	7	1515	3,339	○
	K100	2.55	3.34	1676	66	1753.4	69.0	7	1602	3,532	○
Heavy Duty	K110	0.74	0.97	762	30	1779.1	70.0	3	1070	2,358	●
	K110	0.95	1.24	914	36	1779.1	70.0	4	1216	2,682	●
	K110	1.18	1.54	1067	42	1779.1	70.0	4	1310	2,889	●
	K110	1.41	1.84	1219	48	1779.1	70.0	5	1441	3,178	●
	K110	1.64	2.15	1372	54	1779.1	70.0	5	1539	3,393	●
	K110	1.87	2.45	1524	60	1779.1	70.0	6	1672	3,686	◐
	K110	2.10	2.75	1676	66	1779.1	70.0	7	1805	3,979	◐
	K110	2.34	3.06	1829	72	1779.1	70.0	7	1904	4,197	○
Heavy Duty Rock	K110	0.74	0.97	762	30	1779.1	70.0	3	1131	2,493	●
	K110	0.95	1.24	914	36	1779.1	70.0	4	1293	2,849	●
	K110	1.18	1.54	1067	42	1779.1	70.0	4	1400	3,086	●
	K110	1.41	1.84	1219	48	1779.1	70.0	5	1547	3,411	●
	K110	1.64	2.15	1372	54	1779.1	70.0	5	1660	3,659	●
Heavy Duty Power	K110	0.95	1.24	914	36	1681.8	66.2	4	1192	2,628	●
	K110	1.40	1.83	1219	48	1681.8	66.2	5	1421	3,132	●
	K110	1.63	2.13	1372	54	1681.8	66.2	5	1518	3,346	●
	K110	1.86	2.43	1524	60	1681.8	66.2	6	1650	3,637	●
Ditch Cleaning	N/A	1.63	2.13	1524	60	1410.0	55.5	—	1088	2,399	●
	N/A	1.91	2.50	1830	72	1410.0	55.5	—	1217	2,683	●

Assumptions for maximum material density rating:

1. Front linkage fully extended at ground line
2. Bucket curled
3. 100% bucket fill factor

* Based on SAE J296, some calculations of capacity specs fall on borderlines. Rounding may allow two buckets to have the same English rating, but different metric ratings.

- 2100 kg/m³ (3,500 lb/yd³) max material density
- ◐ 1800 kg/m³ (3,000 lb/yd³) max material density
- 1500 kg/m³ (2,500 lb/yd³) max material density

325D L Work Tool Matching Guide

Boom Options	Reach Boom 6.15 m (20'2")			Mass Boom 5.55 m (18'2")	
Stick Options	R3.75CB2 (12'4")	R3.2CB2 (10'6")	R2.65CB2 (8'8")	M3.2CB2 (10'6")	M2.5DB (8'2")
Hydraulic Hammer	H120Cs/ H130s/ H140Ds	H120Cs/ H130s/ H140Ds	H120Cs/ H130s/ H140Ds	H120Cs/ H130s/ H140Ds	H120Cs/ H130s/ H140Ds
Multi-Processor	MP20	MP20 MP30 (boom mount)	MP20	MP20 N/A	MP20 N/A
360° Scrap Shear	S320	S320/S325* S340 (boom mount)	S320/S325*	S320/S325 N/A	S320/S325 N/A
Mechanical Shear	S115	S115	S115	S115	S115
Mechanical Pulverizer	P120	P120	P120	P120	P120
Trash Grapple**	Available as field installed attachment only				
Contractors' Grapple**	Available as field installed attachment only				
Rotating Sorting/Demolition Grapple	G315	G315/G320	G315/G320	G320	G320
Vibratory Plate Compactor	CVP110	CVP110	CVP110	CVP110	CVP110
Hydraulic Thumb**	Available as field installed attachment only				
Dedicated Quick Coupler**	Available as field installed attachment only				
Pin-Grabber Quick Coupler	Available as factory or field installed attachment			N/A	N/A

* S325 only without PG Coupler.

** Contact Cat Work Tools for availability and proper matching.

Reach Boom Lift Capacities



Load Point Height



Load Radius Over Front



Load Radius Over Side



Load at Maximum Reach - Bucket Curled



Load at Maximum Reach - Bucket Extended

BOOM – 6.15 m (20'2")
R3.75CB2 STICK – 3.75 m (12'4")

BUCKET – 914 mm (36") HDP
with General Duty Tips
982 kg (2,165 lb)

SHOES – 800 mm (32") triple grouser
UNDERCARRIAGE – Long
HEAVY LIFT – On

Diagram	1.5 m (5.0 ft)		3.0 m (10.0 ft)		4.5 m (15.0 ft)		6.0 m (20.0 ft)		7.5 m (25.0 ft)		9.0 m (30.0 ft)		Diagram			Diagram				
	kg	lb	kg	lb	kg	lb	kg	lb	kg	lb	kg	lb	kg	lb	m	ft	kg	lb	m	ft
7.5 m 25 ft									*4850	*4850			*3280	*3280	8.28	26.9	*2650	*2650	8.49	27.4
6.0 m 20 ft									*5580	5200	*3650	3600	*3160	*3160	9.13	29.8	*2450	*2450	9.66	31.6
4.5 m 15 ft									*6160	5050	*5120	3560	*3170	3040	9.68	31.7	*2390	*2390	10.42	34.1
3.0 m 10 ft			*16 310	*16 310	*10 470	*10 470	*8170	7040	*6980	4830	5710	3460	*3290	2800	9.97	32.7	*2400	*2400	10.87	35.6
1.5 m 5 ft					*13 470	10 310	*9740	6580	7580	4590	5580	3330	*3520	2710	10.02	32.9	*2500	2350	11.06	36.3
Ground Line			*6190	*6190	*15 450	9660	10 590	6220	7350	4380	5460	3220	*3920	2740	9.84	32.3	*2670	2320	11.01	36.1
-1.5 m -5 ft	*5280	*5280	*9000	*9000	*16 200	9380	10 340	6000	7210	4250	5390	3160	*4550	2930	9.42	30.9	*2960	2400	10.71	35.1
-3.0 m -10 ft	*8820	*8820	*13 100	*13 100	*15 900	9340	10 260	5940	7170	4210			*5630	3340	8.73	28.5	*3400	2640	10.14	33.2
-4.5 m -15 ft	*13 120	*13 120	*15 860	*15 860	*14 470	9490	10 360	6020	7280	4310			7040	4170	7.67	25.0	*4130	3120	9.24	30.2
-6.0 m -20 ft			*16 020	*16 020	*11 300	9860	*7760	6330									*4570	4150	7.9	25.6

* Limited by hydraulic capacity rather than tipping load. The above loads are in compliance with SAE hydraulic excavator lift capacity rating standard J1097. They do not exceed 87% of hydraulic lifting capacity or 75% of tipping capacity. Weight of all lifting accessories must be deducted from the above lifting capacities.

BOOM – 6.15 m (20'2")
R3.2CB2 STICK – 3.2 m (10'6")

BUCKET – 914 mm (36") HD
with General Duty Tips
982 kg (2,165 lb)

SHOES – 800 mm (32") triple grouser
UNDERCARRIAGE – Long
HEAVY LIFT – On

Diagram	1.5 m (5.0 ft)		3.0 m (10.0 ft)		4.5 m (15.0 ft)		6.0 m (20.0 ft)		7.5 m (25.0 ft)		9.0 m (30.0 ft)		Diagram			Diagram				
	kg	lb	kg	lb	kg	lb	kg	lb	kg	lb	kg	lb	kg	lb	m	ft	kg	lb	m	ft
7.5 m 25 ft									*4330	*4330			*4100	*4100	7.55	24.5	*3120	*3120	7.69	25.2
6.0 m 20 ft									*6350	5080			*3910	*3910	8.48	27.7	*2860	*2860	9.02	29.3
4.5 m 15 ft							*7620	7320	*6850	4970	*4300	3490	*3910	3440	9.06	29.7	*2770	*2770	9.87	32.2
3.0 m 10 ft					*12 060	10 950	*9080	6920	*7610	4780	5670	3430	*4060	3160	9.37	30.7	*2790	*2790	10.36	33.9
1.5 m 5 ft					*14 730	10 120	*10 500	6520	7560	4580	5580	3340	*4360	3060	9.43	30.9	*2890	2620	10.57	34.7
Ground Line			*4870	*4870	*16 150	9650	10 590	6230	7380	4410	5500	3270	*4870	3120	9.24	30.3	*3090	2580	10.51	34.5
-1.5 m -5 ft	*5580	*5580	*9160	*9160	*16 350	9500	10 420	6090	7280	4330			5680	3370	8.79	28.8	*3420	2700	10.18	33.4
-3.0 m -10 ft	*10 150	*10 150	*14 700	*14 700	*15 520	9550	10 420	6090	7300	4340			6580	3930	8.04	26.3	*3950	3000	9.56	31.3
-4.5 m -15 ft			*18 830	*18 830	*13 450	9790	*9870	6240					*7920	5120	6.87	22.3	*4860	3650	8.56	28.0

* Limited by hydraulic capacity rather than tipping load. The above loads are in compliance with SAE hydraulic excavator lift capacity rating standard J1097. They do not exceed 87% of hydraulic lifting capacity or 75% of tipping capacity. Weight of all lifting accessories must be deducted from the above lifting capacities.

Always refer to the appropriate Operation and Maintenance Manual for specific product information.

Reach Boom Lift Capacities



Load Point Height



Load Radius Over Front



Load Radius Over Side



















Load at Maximum Reach – Coupler Curled

BOOM – 6.15 m (20'2")
R3.2CB2 STICK – 3.2 m (10'6")

BUCKET – No Bucket
Bare Quick Coupler

SHOES – 800 mm (32") triple grouser
UNDERCARRIAGE – Long
HEAVY LIFT – On

 7.5 m 25 ft kg lb	1.5 m (5.0 ft)		3.0 m (10.0 ft)		4.5 m (15.0 ft)		6.0 m (20.0 ft)		7.5 m (25.0 ft)		9.0 m (30.0 ft)		 m ft		
															
									*5020 *9,450	*5020 *9,450			*4250 *9,450	*4250 *9,450	7.71 25.0
									*6560 *14,200	5430 11,650			*4050 *8,950	*4050 *8,950	8.62 28.1
							*7720 *16,750	7600 16,350	*7050 *15,400	5280 11,350	*4990 *9,250	3840 8,250	*4020 *8,850	3690 8,150	9.2 30.1
					*11 980 *25,750	11 210 24,150	*9190 *19,900	7180 15,500	*7820 *17,000	5070 10,900	6000 12,900	3750 8,050	*4130 *9,100	3410 7,550	9.5 31.2
					*14 780 *31,850	10 380 22,350	*10 660 *23,050	6780 14,600	7830 16,850	4850 10,450	5880 12,650	3650 7,850	*4380 *9,650	3300 7,300	9.56 31.4
Ground Line			*5740 *13,200	*5740 *13,200	*16 350 *35,400	9910 21,300	10 820 23,250	6480 13,950	7640 16,450	4680 10,100	5790 12,450	3560 7,650	*4830 *10,650	3350 7,400	9.37 30.7
-1.5 m -5 ft	kg lb	*5940 *13,300	*5940 *13,300	*9650 *21,900	*9650 *21,900	*16 690 *36,150	9730 20,950	10 650 22,900	6330 13,650	7530 16,200	4590 9,900		*5570 *12,300	3570 7,900	8.93 29.3
-3.0 m -10 ft	kg lb	*10 270 *23,050	*10 270 *23,050	*14 840 *33,700	*14 840 *33,700	*15 970 *34,600	9760 21,000	10 620 22,850	6310 13,600	7530 16,250	4590 9,900		6640 14,750	4080 9,050	8.19 26.8
-4.5 m -15 ft	kg lb			*17 750 *39,850	*17 750 *39,850	*14 040 *30,200	9950 21,400	*10 420 *22,250	6440 13,900				*8190 *18,050	5160 11,550	7.05 22.9

* Limited by hydraulic capacity rather than tipping load. The above loads are in compliance with SAE hydraulic excavator lift capacity rating standard J1097. They do not exceed 87% of hydraulic lifting capacity or 75% of tipping capacity. Weight of all lifting accessories must be deducted from the above lifting capacities.



Load Point Height



Load Radius Over Front



Load Radius Over Side



Load at Maximum Reach – Bucket Curled





















Load at Maximum Reach – Bucket Extended

BOOM – 6.15 m (20'2")
R2.65CB2 STICK – 2.65 m (8'8")

BUCKET – 914 mm (36") HD
with General Duty Tips
982 kg (2,165 lb)

SHOES – 800 mm (32") triple grouser
UNDERCARRIAGE – Long
HEAVY LIFT – On

 7.5 m 25 ft kg lb	3.0 m (10.0 ft)		4.5 m (15.0 ft)		6.0 m (20.0 ft)		7.5 m (25.0 ft)		9.0 m (30.0 ft)		 m ft		 m ft			
																
											*5260 *11,700	*5260 *11,700	7.08 22.9	*4020 *8,860	*4020 *8,860	7.07 23.2
							*6930 *15,100	5080 10,850			*4990 *11,000	4390 9,800	8.06 26.3	*3670 *8,150	*3670 *8,150	8.5 27.6
					*8250 *17,900	7290 15,700	*7340 *16,000	4980 10,700			*4970 *10,950	3780 8,400	8.67 28.4	*3540 *7,800	3490 7,750	9.38 30.6
			*13 020 *27,950	10 780 23,250	*9650 *20,850	6900 14,850	7810 16,750	4810 10,350			*5140 *11,300	3470 7,650	9.0 29.5	*3550 *7,800	3080 6,800	9.89 32.4
			*15 420 *33,250	10 010 21,600	10 910 23,450	6530 14,050	7600 16,350	4620 9,950	5640 12,430	3400 7,490	*5510 *12,100	3360 7,400	9.06 29.7	*3660 *8,050	2890 6,400	10.1 33.1
Ground Line			*16 000 *35,600	9650 20,750	10 620 22,800	6280 13,500	7450 16,000	4480 9,650			5720 12,600	3440 7,600	8.86 29.1	*3890 *8,550	2860 6,300	10.04 33.0
-1.5 m -5 ft	kg lb	*9290 *21,150	*9290 *21,150	*16 180 *35,300	9580 20,600	10 500 22,550	6170 13,300	7380 15,900	4420 9,550		6220 13,750	3740 8,250	8.39 27.5	*4260 *9,400	3010 6,600	9.7 31.8
-3.0 m -10 ft	kg lb	*14 240 *31,550	*14 240 *31,550	*15 140 *32,750	9690 20,850	10 550 22,650	6210 13,400	7450 16,400	4490		7320 16,250	4410 9,800	7.6 24.8	*4860 *10,750	3370 7,450	9.06 29.7
-4.5 m -15 ft	kg lb	*15 810 *35,400	*15 810 *35,400	*12 610 *27,000	9980 21,500	*9090 *19,100	6440 13,900				*8170 *18,000	5940 13,350	6.35 20.6	*5600 *12,250	4170 9,300	8.02 26.2

* Limited by hydraulic capacity rather than tipping load. The above loads are in compliance with SAE hydraulic excavator lift capacity rating standard J1097. They do not exceed 87% of hydraulic lifting capacity or 75% of tipping capacity. Weight of all lifting accessories must be deducted from the above lifting capacities.

Always refer to the appropriate Operation and Maintenance Manual for specific product information.

Reach Boom Lift Capacities



Load Point
Height



Load Radius
Over Front



Load Radius
Over Side

















Load at Maximum
Reach – Coupler Curled

BOOM – 6.15 m (20'2")
R2.65CB2 STICK – 2.65 m (8'8")

BUCKET – No Bucket
Bare Quick Coupler

SHOES – 800 mm (32") triple grouser
UNDERCARRIAGE – Long
HEAVY LIFT – On

	3.0 m (10.0 ft)		4.5 m (15.0 ft)		6.0 m (20.0 ft)		7.5 m (25.0 ft)		9.0 m (30.0 ft)				m ft
													
6.0 m 20 ft	kg lb						*7250 *15,800	5380 11,550			*5560 *12,350	*5560 *12,350	7.12 23.0
4.5 m 15 ft	kg lb				*8500 *18,450	7510 16,200	*7650 *16,700	5260 11,300			*5240 *11,600	4680 10,450	8.1 26.4
3.0 m 10 ft	kg lb		*13 240 *28,450	10 990 23,700	*9910 *21,450	7130 15,350	8060 17,350	5070 10,900	*5560 *12,250	3770 8,310	*5180 *11,400	4060 9,000	8.71 28.5
1.5 m 5 ft	kg lb		*15 720 *33,900	10 280 22,150	11 130 23,950	6770 14,600	7850 16,900	4880 10,500	5920 13,050	3690 8,130	*5310 *11,700	3750 8,300	9.03 29.6
Ground Line	kg lb		*16 790 *36,350	9940 21,400	10 850 23,350	6530 14,050	7690 16,550	4740 10,200			*5620 *12,400	3640 8,000	9.09 29.8
-1.5 m -5 ft	kg lb	*9550 *21,750	*9550 *21,750	*16 660 *36,100	9860 21,200	10 740 23,100	6420 13,850	7620 16,400	4680 10,100		5970 13,150	3700 8,150	8.89 29.2
-3.0 m -10 ft	kg lb	*15 080 *33,550	*15 080 *33,550	*15 510 *33,600	9950 21,400	10 770 23,150	6450 13,900	7690 16,950	4740 10,440		6440 14,250	3990 8,800	8.43 27.6
-4.5 m -15 ft	kg lb	*17 640 *37,950	*17 640 *37,950	*12 980 *27,850	10 200 21,950	*9450 *19,900	6650 14,400				7500 16,650	4630 10,300	7.63 24.9

* Limited by hydraulic capacity rather than tipping load. The above loads are in compliance with SAE hydraulic excavator lift capacity rating standard J1097. They do not exceed 87% of hydraulic lifting capacity or 75% of tipping capacity. Weight of all lifting accessories must be deducted from the above lifting capacities.

Always refer to the appropriate Operation and Maintenance Manual for specific product information.

Super Long Reach Boom Lift Capacities



Load Point Height



Load Radius Over Front



Load Radius Over Side





















Load at Maximum Reach - Bucket Curled

BOOM – 10.2 m (33'6")
STICK – 7.85 m (25'9")

BUCKET – 1142 mm (45")
Ditch Cleaning Bucket
290 kg (639 lb)

SHOES – 800 mm (32") triple grouser
UNDERCARRIAGE – Long
HEAVY LIFT – On

	6.0 m (20.0 ft)		7.5 m (25.0 ft)		9.0 m (30.0 ft)		10.5 m (35.0 ft)		12.0 m (40.0 ft)		13.5 m (45.0 ft)		15.0 m (50.0 ft)				m ft	
																		
13.5 m 45 ft	kg lb															*1140 *2,550	*1140 *2,550	13.59 43.98
12.0 m 40 ft	kg lb															*1050 *2,350	*1050 *2,350	14.76 47.97
10.5 m 35 ft	kg lb													*1800 *3,250	1700 *3,250	*1000 *2,200	*1000 *2,200	15.69 51.16
9.0 m 30 ft	kg lb													*2280 *4,700	1710 3,600	*970 *2,150	*970 *2,150	16.43 53.69
7.5 m 25 ft	kg lb											*2290 *5,050	2100 4,650	*2330 *5,150	1670 3,550	*950 *2,100	*950 *2,100	17.01 55.66
6.0 m 20 ft	kg lb											*2460 *5,400	2080 4,450	*2430 *5,350	1610 3,400	*940 *2,100	*940 *2,100	17.43 57.12
4.5 m 15 ft	kg lb									*2770 *6,050	2510 5,350	*2650 *5,800	1960 4,200	*2560 *5,600	1530 3,250	*950 *2,100	930 2,050	17.72 58.11
3.0 m 10 ft	kg lb						*3360 *7,300	2970 6,400	*3070 *6,700	2330 5,000	*2860 *6,250	1830 3,900	2580 5,500	1450 3,050	*980 *2,150	870 1,950	17.88 58.65	
1.5 m 5 ft	kg lb	*6880 *14,800	6230 13,450	*5300 *11,450	4560 9,850	*4380 *9,500	3470 7,500	*3790 *8,200	2710 5,850	*3380 *7,350	2140 4,600	3000 6,450	1700 3,650	2480 5,300	1350 2,900	*1010 *2,250	830 1,850	17.91 58.76
Ground Line	kg lb	*8090 *17,450	5440 11,750	*6110 *13,200	4050 8,750	*4950 *10,700	3130 6,750	*4200 *9,100	2470 5,300	3470 7,450	1970 4,200	2870 6,150	1580 3,350	2390 5,100	1270 2,700	*1060 *2,350	820 1,800	17.81 58.44
-1.5 m -5 ft	kg lb	*8580 *19,200	4910 10,600	6580 14,150	3660 7,900	5070 10,900	2850 6,150	4050 8,700	2260 4,850	3310 7,100	1820 3,900	2750 5,900	1470 3,150	2310 4,950	1190 2,550	*1130 *2,500	820 1,800	17.59 57.68
-3.0 m -10 ft	kg lb	*7980 *17,800	4610 9,950	6290 13,550	3400 7,350	4850 10,450	2640 5,700	3880 8,350	2110 4,500	3190 6,850	1700 3,650	2660 5,700	1380 2,950	2240 4,800	1130 2,400	*1220 *2,700	850 1,850	17.22 56.47
-4.5 m -15 ft	kg lb	*7800 *17,400	4460 9,600	6120 13,200	3250 7,000	4700 10,100	2510 5,400	3770 8,100	2000 4,300	3100 6,650	1620 3,450	2590 5,600	1320 2,850	2210 4,750	1090 2,350	*1340 *2,950	900 2,000	16.72 54.77
-6.0 m -20 ft	kg lb	*7840 *17,500	4430 9,550	6050 13,050	3190 6,850	4630 9,950	2440 5,250	3700 7,950	1940 4,150	3050 6,550	1570 3,350	2560 5,500	1290 2,800	2200 4,750	1080 2,350	*1500 *3,350	980 2,150	16.06 52.53
-7.5 m -25 ft	kg lb	*8070 *18,050	4480 9,650	6060 13,050	3190 6,900	4620 9,950	2430 5,250	3690 7,950	1930 4,150	3040 6,550	1570 3,350	2570 5,550	1300 2,800	2240 4,930	1120 2,460	*1720 *3,850	1100 2,450	15.22 49.69
-9.0 m -30 ft	kg lb	*8530 *18,850	4600 9,950	6140 13,250	3270 7,050	4670 10,100	2480 5,350	3730 8,050	1970 4,250	3090 6,700	1610 3,500	2640 5,750	1370 3,000			*2040 *4,600	1300 2,900	14.17 46.13
-10.5 m -35 ft	kg lb	*8660 *18,600	4810 10,400	6300 13,600	3410 7,400	4790 10,350	2590 5,600	3840 8,350	2070 4,500	3210 7,000	1720 3,750					*2560 *5,800	1600 3,600	12.87 41.67
-12.0 m -40 ft	kg lb	*7600 *16,150	5110 11,100	*6120 *12,950	3640 7,900	*4990 *10,500	2790 6,100	*4000 *8,200	2270 5,000							*3490 *7,700	2110 4,850	11.21 35.96
-13.5 m -45 ft	kg lb	*5880 *12,960	5550 12,230	*4640 *9,300	4010 8,800													

* Limited by hydraulic capacity rather than tipping load. The above loads are in compliance with SAE hydraulic excavator lift capacity rating standard J1097.

They do not exceed 87% of hydraulic lifting capacity or 75% of tipping capacity. Weight of all lifting accessories must be deducted from the above lifting capacities.

Always refer to the appropriate Operation and Maintenance Manual for specific product information.

Mass Boom Lift Capacities



Load Point Height



Load Radius Over Front



Load Radius Over Side



Load at Maximum Reach - Bucket Curled



Load at Maximum Reach - Bucket Extended

BOOM – 5.55 m (18'2")
M3.2CB2 STICK – 3.2 m (10'6")

BUCKET – 914 mm (36") HD
with General Duty Tips
982 kg (2,165 lb)

SHOES – 800 mm (32") triple grouser
UNDERCARRIAGE – Long
HEAVY LIFT – On

Load Point Height	1.5 m (5.0 ft)		3.0 m (10.0 ft)		4.5 m (15.0 ft)		6.0 m (20.0 ft)		7.5 m (25.0 ft)		Load at Maximum Reach - Bucket Curled			Load at Maximum Reach - Bucket Extended				
	kg	lb	kg	lb	kg	lb	kg	lb	kg	lb	kg	lb	m	ft	kg	lb	m	ft
7.5 m 25 ft											*3920 *8,700	*3920 *8,700	6.87 22.2		*2820 *6,250	*2820 *6,250	8.3 26.9	
6.0 m 20 ft									*5100 *10,100	5090 *10,100	*3690 *8,150	*3690 *8,150	7.88 25.7		*2710 *5,950	*2710 *5,950	9.2 30.1	
4.5 m 15 ft							*7680 *16,750	7470 16,050	*6720 *14,200	5030 10,800	*3680 *8,100	*3680 *8,100	8.51 27.8		*2720 *6,000	*2720 *6,000	9.73 31.9	
3.0 m 10 ft			*17 280 *36,850	*17 280 *36,850	*11 410 *24,600	*11 410 *24,550	*9050 *19,650	7110 15,300	*7840 *16,950	4860 10,450	*3820 *8,400	3580 7,900	8.83 29.0		*2820 *6,200	*2820 *6,200	9.94 32.6	
1.5 m 5 ft			*9390 *22,350	*9390 *22,350	*14 270 *30,800	10 540 22,700	*10 500 *22,750	6710 14,450	7680 16,500	4670 10,050	*4140 *9,100	3460 7,600	8.9 29.2		*3040 *6,700	2930 6,450	9.88 32.4	
Ground Line			*9430 *21,600	*9430 *21,600	*16 070 *34,750	9950 21,400	10 790 23,200	6400 13,750	7500 16,100	4510 9,700	*4680 *10,300	3530 7,800	8.7 28.5		*3410 *7,500	3070 6,750	9.54 31.3	
-1.5 m -5 ft	*7680 *17,200	*7680 *17,200	*13 300 *30,250	*13 300 *30,250	*16 510 *35,750	9710 20,850	10 600 22,750	6220 13,400	7400 15,900	4420 9,500	*5610 *12,400	3840 8,500	8.22 26.9		*4010 *8,850	3450 7,650	8.88 29.1	
-3.0 m -10 ft	*12 490 *28,050	*12 490 *28,050	*15 470 *34,450	*15 470 *34,450	*15 620 *33,750	9720 20,900	10 580 22,750	6210 13,400			*7390 *16,500	4550 10,100	7.4 24.2		*5110 *11,350	4310 9,600	7.81 25.5	
-4.5 m -15 ft			*17 700 *39,700	*17 700 *39,700	*12 950 *27,650	9970 21,450	*8920 *19,660	6420 14,150			*8580 *18,900	6240 14,050	6.12 19.8					

* Limited by hydraulic capacity rather than tipping load. The above loads are in compliance with SAE hydraulic excavator lift capacity rating standard J1097. They do not exceed 87% of hydraulic lifting capacity or 75% of tipping capacity. Weight of all lifting accessories must be deducted from the above lifting capacities.

BOOM – 5.55 m (18'2")
M2.5DB STICK – 2.5 m (8'2")

BUCKET – 1219 mm (48") HD
with General Duty Tips
1441 kg (3,177 lb)

SHOES – 800 mm (32") triple grouser
UNDERCARRIAGE – Long
HEAVY LIFT – On

Load Point Height	1.5 m (5.0 ft)		3.0 m (10.0 ft)		4.5 m (15.0 ft)		6.0 m (20.0 ft)		7.5 m (25.0 ft)		Load at Maximum Reach - Bucket Curled			Load at Maximum Reach - Bucket Extended				
	kg	lb	kg	lb	kg	lb	kg	lb	kg	lb	kg	lb	m	ft	kg	lb	m	ft
6.0 m 20 ft							*7430 *16,300	7180 15,350			*5860 *13,050	*5860 *13,050	5.96 19.2		*3870 *8,600	*3870 *8,600	7.5 24.3	
4.5 m 15 ft							*8240 *17,900	6990 15,000	*7310 *14,400	4560 9,750	*5520 *12,200	5120 11,450	7.1 23.1		*3720 *8,200	*3720 *8,200	8.52 27.8	
3.0 m 10 ft					*12 470 *26,850	10 750 23,150	*9490 *20,550	6640 14,250	7470 16,000	4440 9,500	*5550 *12,250	4200 9,350	7.79 25.5		*3760 *8,300	3220 7,150	9.09 29.8	
1.5 m 5 ft					*14 890 *32,150	9910 21,350	10 710 23,000	6270 13,500	7290 15,650	4290 9,200	*5860 *12,900	3760 8,300	8.15 26.7		*3950 *8,700	2960 6,550	9.32 30.6	
Ground Line			*8240 *19,000	*8240 *19,000	*16 040 *34,700	9450 20,300	10 410 22,350	6010 12,900	7160 15,350	4160 8,950	6210 13,700	3610 7,950	8.22 27.0		*4290 *9,450	2920 6,450	9.25 30.4	
-1.5 m -5 ft	*8810 *19,750	*8810 *19,750	*14 680 *33,450	*14 680 *33,450	*15 840 *34,300	9340 20,050	10 290 22,100	5910 12,700			6420 14,150	3720 8,200	8.0 26.2		*4870 *10,750	3120 6,900	8.86 29.1	
-3.0 m -10 ft			*20 260 *43,850	19 700 42,100	*14 270 *30,800	9480 20,400	*10 270 *22,000	5990 12,900			7170 15,850	4160 9,200	7.47 24.5		*5840 *12,950	3660 8,100	8.13 26.6	
-4.5 m -15 ft					*10 340 *21,700	9920 21,400					*8880 *19,600	5220 11,650	6.57 21.4					

* Limited by hydraulic capacity rather than tipping load. The above loads are in compliance with SAE hydraulic excavator lift capacity rating standard J1097. They do not exceed 87% of hydraulic lifting capacity or 75% of tipping capacity. Weight of all lifting accessories must be deducted from the above lifting capacities.

Always refer to the appropriate Operation and Maintenance Manual for specific product information.

Standard Equipment

Standard equipment may vary. Consult your Caterpillar® dealer for details.

Electrical

- 65 Ampere alternator
- Base machine light (frame)
- Lights, cab mounted (Two)
- Horn
- Pre-Start monitoring system – checks for low fluids (engine oil, coolant, hydraulic oil) prior to starting machine

Operator Environment

- Air conditioner, heater, defroster with automatic climate control
- AM/FM Radio with antenna and 2 speakers
- Ashtray with 24 volt lighter
- Beverage/cup holder
- Bolt-on Falling Object Guarding System (FOGS) capability
- Cab Glass
 - Openable and retractable two-piece front windshield
 - Sky-light, pop-up, polycarbonate
- Coat Hook
- Floor mat
- Instrument panel and gauges
- Joysticks, console mounted, pilot operated
- Light, interior
- Literature compartment
- Monitor, full graphic color display
- Neutral lever (lock out) for all controls
- Polycarbonate side windows
- Positive filtered ventilation
- Pressurized cab
- Seat, suspension, with high back and head rest
- Seat belt, retractable – 76 mm (3")
- Sun shade (for skylight)
- Travel control pedals with removable hand levers
- Windshield wiper and washer (upper and lower)

Engine/Power Train

- C7 with ACERT® Technology
 - Air Intake Heater
 - Air-to-air Aftercooler (ATAAC)
 - 24V Electric Starting
 - Hydraulic electronic unit injectors (HEUI)
 - 2300 m (7,500 ft) Altitude capability without derate
 - Automatic engine speed control with one touch low idle
- Cooling
 - Protection of 43° C to –18° C (109° F to 0° F) at 50% concentration
- Electric Priming Pump
- Straight line travel
- Two speed auto-shift travel
- Water separator in fuel line
 - Water level indicator for water separator
- Undercarriage
 - Grease lubricated track
 - Hydraulic track adjusters
 - Idler and center section track guards
 - Track Shoes – 800 mm (32") triple grouser
- Other Standard Equipment
 - Automatic swing parking brake
 - Auxiliary hydraulic valve
 - Capability of stackable valves (max of 3) for main valve
 - Capability of auxiliary circuit
 - Counterweight with lifting eyes
 - Door locks, cap locks and Caterpillar one key security system
 - Fine swing control
 - Fully pressurized hydraulic system
 - Heavy Lift
 - Mirrors (frame-right, cab-left)
 - S•O•SSM quick sampling valves for engine and hydraulic oil
 - Travel Alarm
 - Wiring provision for Product Link

Optional Equipment

Optional equipment may vary. Consult your Caterpillar® dealer for details.

Front Linkage

Booms

- Reach 5.9 m (19 ft 4 in)
- Mass 5.3 m (17 ft 5 in)
- Super Long Reach 10.2 m (33 ft 6 in)

Sticks

- Reach 3.6 m (11 ft 10 in)
- Reach 2.95 m (9 ft 8 in)
- Reach 2.5 m (8 ft 2 in)
- Mass 2.5 m (8 ft 2 in)
- Super Long Reach 7.85 m (25 ft 9 in)

Bucket Linkage

- B1 Family
- CB1 Family
- DB Family
- Boom Lowering Control Device

Electrical

- Product Link (PL121SR/PL321SR)
- Machine Security System (MSS)
- Power Supply (12V-10 Amp)

Guarding

- Falling Object Guarding System (FOGS)
 - Full length, wire mesh
- Heavy-Duty Bottom Guards
- Rubber Bumpers (side)
- Track Guiding Guards
 - Sprocket End, Idler end guard
 - Two-piece full length (center guard removed)
- Vandalism Guards

Operator Environment

- Hand Control Pattern Changer (ISO-SAE)
- Rear window, secondary exit
- Sun screen – roller type
- Seat, high back with air suspension and heater
- Third pedal, straight travel

Engine/Power Train

- High Ambient Cooling
 - For conditions up to 52° C (125° F)
- Prefilter, Air
- Starting, Cold Weather Package
 - Two additional maintenance free batteries
 - High capacity starter motor
 - Heavy-duty cable
 - Jump-start receptacle
 - Ether aid
 - Block heater

Undercarriage

- Track Shoes
 - 600 mm (24") double grouser
 - 700 mm (28") double grouser
 - 800 mm (32") heavy-duty triple grouser

Heavy-duty rollers

Auxiliary Hydraulics

- Hammer Circuit
 - For single function (1 way/2 pump) hydraulic tools
- Thumb Circuit
 - For double function (2 way/1 pump) hydraulic tools
- Tool Control System
 - For single or double function, (1 or 2 way, (1 or 2 pump) hydraulic tools
 - Joysticks with additional switches
 - Program up to 10 tools in memory
 - Capability of adding medium pressure
 - Medium Pressure Circuit for tools requiring medium pressure
- Hydraulic Pin Grabber Quick Coupler and controller
- Lines for Booms and Sticks

Work Tools

- Wide Offering of Buckets, Tips and sidecutters

Notes

325D L Hydraulic Excavator

AEHQ5665-01 (3-07)

Replaces AEHQ5665

NACD/LACD

For more complete information on Cat products, dealer services,
and industry solutions, visit us on the web at www.cat.com

© 2007 Caterpillar
All Rights Reserved
Printed in U.S.A.

Materials and specifications are subject to change without notice.
Featured machines in photos may include additional equipment.
See your Caterpillar dealer for available options.

CAT, CATERPILLAR, their respective logos, "Caterpillar Yellow" and the
POWER EDGE trade dress, as well as corporate and product identity used herein,
are trademarks of Caterpillar and may not be used without permission.

CATERPILLAR[®]