

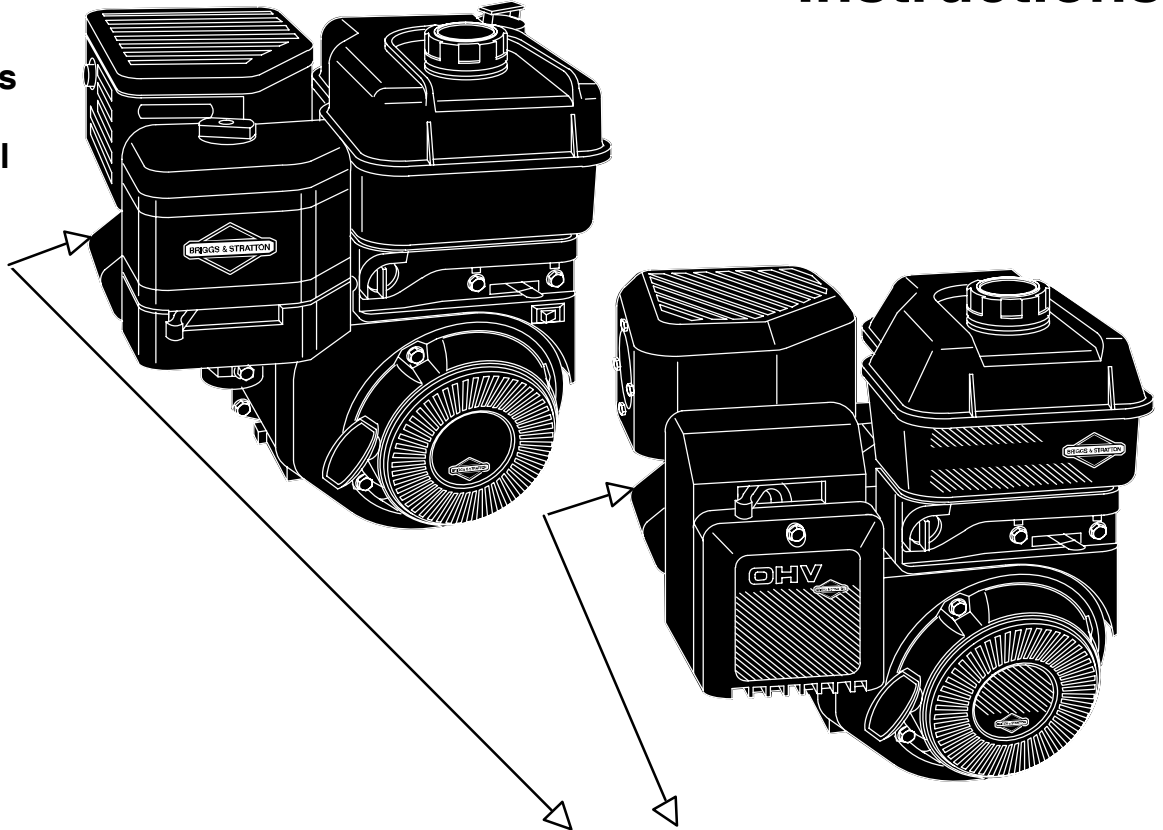

Operating & Maintenance Instructions

Model Series Covered in This Manual

110000
120000
200000
210000



| Model | Type | Code |
|----------------------|----------------------|----------------------|
| <input type="text"/> | <input type="text"/> | <input type="text"/> |

Note: General Model Series numbers noted above are inclusive of the specific model number found on your engine. To get replacement parts or technical assistance in the future, write your engine Model, Type, Code and date of purchase here.

Month / Day / Year

| | | | | | |
|----------------------|----------------------|----------------------|----------------------|----------------------|----------------------|
| <input type="text"/> | <input type="text"/> | <input type="text"/> | <input type="text"/> | <input type="text"/> | <input type="text"/> |
|----------------------|----------------------|----------------------|----------------------|----------------------|----------------------|

TABLE OF CONTENTS

| | |
|-------------------------------------|-------|
| Safety | 3-5 |
| Engine Information | 6 |
| Oil | 7 |
| Fuel and Starting Information | 8 |
| Starting and Stopping | 9-10 |
| Maintenance | 11-14 |
| Parts and Service & Storage | 15-16 |
| Warranty Information | 17 |





WARNING

Briggs & Stratton does not approve or authorize the use of these engines on 3-wheel All Terrain Vehicles (ATVs), motor bikes, fun/recreational go-karts, aircraft products or vehicles intended for use in competitive events. Use of these engines in such applications could result in property damage, serious injury (including paralysis), or even death.

Need assistance? Go to www.briggsandstratton.com for detailed information regarding Briggs & Stratton engines. Or call, **1-800-233-3723**, (U.S.A. and Canada) to hear a menu of pre-recorded messages offering engine maintenance information.

1



BEFORE OPERATING ENGINE



- Read entire Operating & Maintenance Instructions AND the instructions for the equipment this engine powers.*
- Failure to follow instructions could result in serious injury or death.

THE OPERATING & MAINTENANCE INSTRUCTIONS CONTAIN SAFETY INFORMATION TO

- Make you aware of hazards associated with engines
- Inform you of the risk of injury associated with those hazards, and
- Tell you how to avoid or reduce the risk of injury.

The safety alert symbol () is used to identify safety information about hazards that can result in personal injury.

A signal word (DANGER, WARNING, or CAUTION) is used with the alert symbol to indicate the likelihood and the potential severity of injury. In addition, a hazard symbol may be used to represent the type of hazard.

-  **DANGER** indicates a hazard which, if not avoided, **will result in death or serious injury.**
 -  **WARNING** indicates a hazard which, if not avoided, **could result in death or serious injury.**
 -  **CAUTION** indicates a hazard which, if not avoided, **might result in minor or moderate injury.**
- CAUTION**, when used **without** the alert symbol, indicates a situation that **could result in damage to the engine.**









WARNING





The engine exhaust from this product contains chemicals known to the State of California to cause cancer, birth defects, or other reproductive harm.

HAZARD SYMBOLS AND MEANINGS

| | | |
|--|---|---|
|  |  |  |
| Fire | Explosion | Moving Parts |
|  |  |  |
| Toxic Fumes | Hot Surface | Shock |
| |  | |
| | Kickback | |

THE INTERNATIONAL SYMBOLS USED ON THE ENGINE OR IN THIS MANUAL INCLUDE:

| | | |
|--|---|---|
|  |  |  |
| Safety Alert | Read Owner's Manual | On Off |
|  |  |  |
| Oil | Stop | Fuel Shutoff |
| |  |  |
| | Choke | Fuel |

* Briggs & Stratton does not necessarily know what equipment this engine will power. For that reason, you should carefully read and understand the operating instructions for the equipment on which your engine is placed.



WARNING

Gasoline and its vapors are extremely flammable and explosive.



Fire or explosion can cause severe burns or death.

WHEN ADDING FUEL

- Turn engine OFF and let engine cool at least 2 minutes before removing gas cap.
- Fill fuel tank outdoors or in well-ventilated area.
- Do not overfill fuel tank. Fill tank to approximately 1-1/2 inches below top of neck to allow for fuel expansion.
- Keep gasoline away from sparks, open flames, pilot lights, heat, and other ignition sources.
- Check fuel lines, tank, cap, and fittings frequently for cracks or leaks. Replace if necessary.

WHEN STARTING ENGINE

- Make sure spark plug, muffler, fuel cap and air cleaner are in place.
- Do not crank engine with spark plug removed.
- If fuel spills, wait until it evaporates before starting engine.
- If engine floods, set choke to OPEN/RUN position, place throttle in FAST and crank until engine starts.

WHEN OPERATING EQUIPMENT

- Do not tip engine or equipment at angle which causes gasoline to spill.
- Do not choke carburetor to stop engine.

WHEN TRANSPORTING EQUIPMENT

- Transport with fuel tank EMPTY or with fuel shut-off valve OFF.

WHEN STORING GASOLINE OR EQUIPMENT WITH FUEL IN TANK

- Store away from furnaces, stoves, water heaters or other appliances that have pilot light or other ignition source because they can ignite gasoline vapors.



WARNING

Starting engine creates sparking.



Sparking can ignite nearby flammable gases.

Explosion and fire could result.

- If there is natural or LP gas leakage in area, do not start engine.
- Do not use pressurized starting fluids because vapors are flammable.



WARNING

Rapid retraction of starter cord (kickback) will pull hand and arm toward engine faster than you can let go.

Broken bones, fractures, bruises or sprains could result.

- When starting engine, pull cord slowly until resistance is felt, then pull rapidly.
- Remove all external equipment/engine loads before starting engine.
- Direct coupled equipment components such as, but not limited to, blades, impellers, pulleys, sprockets, etc., must be securely attached.





WARNING

Rotating parts can contact or entangle hands, feet, hair, clothing, or accessories.

Traumatic amputation or severe laceration can result.

- Operate equipment with guards in place.
- Keep hands and feet away from rotating parts.
- Tie up long hair and remove jewelry.
- Do not wear loose-fitting clothing, dangling drawstrings or items that could become caught.

 **WARNING**

 Engines give off carbon monoxide, an odorless, colorless, poison gas.

Breathing carbon monoxide can cause nausea, fainting or death.

- Start and run engine outdoors.
- Do not start or run engine in enclosed area, even if doors or windows are open.

 **WARNING**

 Running engines produce heat. Engine parts, especially muffler, become extremely hot.

 Severe thermal burns can occur on contact.

 Combustible debris, such as leaves, grass, brush, etc. can catch fire.

- Allow muffler, engine cylinder and fins to cool before touching.
- Remove accumulated combustibles from muffler area and cylinder area.
- Install and maintain in working order a spark arrester before using equipment on forest-covered, grass-covered, brush-covered unimproved land. The state of California requires this (Section 4442 of the California Public Resources Code). Other states may have similar laws. Federal laws apply on federal land.

 **WARNING**



[Redacted content]

ENGINE INFORMATION

BRIGGS & STRATTON

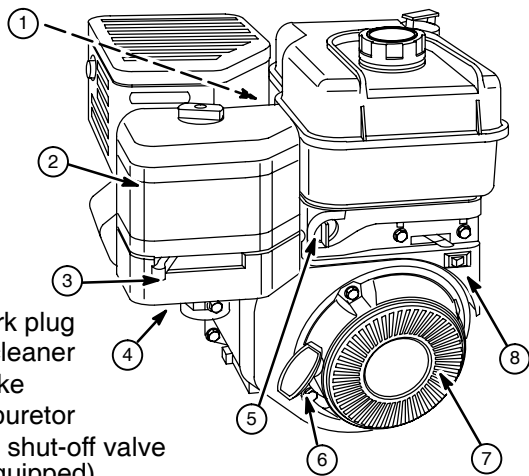

1. Spark plug
2. Air cleaner
3. Choke
4. Carburetor
5. Fuel shut-off valve (if equipped)
6. Rope handle
7. Finger guard
8. Stop switch/OIL GARD® light (if equipped)
9. Fuel fill

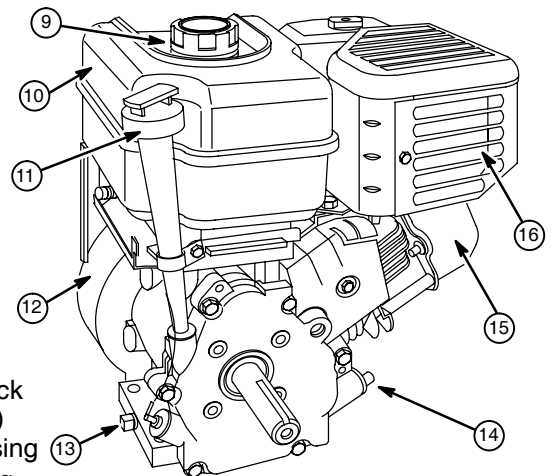

10. Fuel tank
11. Oil fill/Dipstick (if equipped)
12. Blower housing
13. Oil drain plug
14. Oil fill cap
15. Engine Model Type Code
xxxxx xxxx xx xxxxxxxx
16. Muffler/(Muffler guard, if equipped)/
(Spark arrester, if equipped)

GENERAL INFORMATION

ENGINE MODEL

This is a single cylinder, overhead valve (OHV), air-cooled engine. It is a low emissions engine.

In the state of California, OHV Model Series 110000 and 120000 engines are certified by the California Air Resources Board to meet emissions standards for 125 hours. OHV Model Series 200000, 210000 engines are certified by the California Air Resources Board to meet emissions standards for 250 hours. Such certification does not grant the purchaser, owner or operator of this engine any additional warranties with respect to the performance or operational life of this engine. This engine is warranted solely according to the product and emissions warranties stated elsewhere in this manual.

Note: For practical operation, horsepower loading should not exceed 85% of rated horsepower. Engine power will decrease 3-1/2% for each 1,000 feet (300 meters) above sea level and 1% for each 10° F (5.6° C) above 77° F (25° C). Engine will operate satisfactorily at an angle up to 15°.

MODEL SERIES 110000

Bore 2-11/16 in. (68 mm)
Stroke 2-3/64 in. (52 mm)
Displacement 11.58 cu. in. (190 cc)

MODEL SERIES 120000

Bore 2-11/16 in. (68 mm)
Stroke 2-13/64 in. (56 mm)
Displacement 12.48 cu. in. (206 cc)

MODEL SERIES 200000

Bore 3.120 in. (79.23 mm)
Stroke 2.438 in. (61.67 mm)
Displacement 18.64 cu. in. (305 cc)

MODEL SERIES 210000

Bore 3.300 in. (83.81 mm)
Stroke 2.438 in. (61.67 mm)
Displacement 20.85 cu. in. (342 cc)

TUNE-UP SPECIFICATIONS

Models 110000/120000

Armature air gap ... 0.010 – 0.014 in. (0.25 – 0.36 mm)
Spark plug gap 0.030 in. (0.76 mm)
Valve clearance with valve springs installed and piston 1/4 in. (6 mm) past top dead center (check when engine is cold). See Repair Manual P/N 272147.
Intake 0.004 – 0.006 in. (0.10 – 0.15 mm)
Exhaust 0.009 – 0.011 in. (0.23 – 0.28 mm)

TUNE-UP SPECIFICATIONS

Models 200000/210000

Armature air gap ... 0.008 – 0.012 in. (0.20 – 0.30 mm)
Spark plug gap 0.030 in. (0.76 mm)
Valve clearance with valve springs installed and piston 1/4 in. (6 mm) past top dead center (check when engine is cold). See Repair Manual P/N 272147.
Intake 0.004 – 0.006 in. (0.10 – 0.15 mm)
Exhaust 0.004 – 0.006 in. (0.10 – 0.15 mm)



CAUTION: This engine is shipped from Briggs & Stratton without oil. Check oil level before starting engine. If you start the engine without oil, the engine will be damaged beyond repair and will not be covered under warranty.



Note: Synthetic oil meeting ILSAC GF-2, API certification mark and API service symbol (shown at left) with "SJ/CF ENERGY CONSERVING" or higher, is an acceptable oil at all temperatures. **Use of synthetic oil does not alter required oil change intervals.**

Note: If this engine is equipped with gear reduction, gear reduction case must be filled with oil prior to operating engine. See gear reduction oil filling instructions on page 12.

OIL CAPACITY

Model 110000 and 120000 series engines hold approximately 5/8 quart (20 ounces; 0.6 liter).

Model series 200000 and 210000 engines hold approximately 7/8 quart (28 ounces; 0.8 liter).

TYPE OF OIL TO USE

- Use a high quality detergent oil classified "For Service SF, SG, SH, SJ" or higher, such as Briggs & Stratton SAE 30, Part Number 100005 (20 oz) or 100028 (48 oz).
- Do not use special additives.
- Choose a viscosity according to the table opposite.

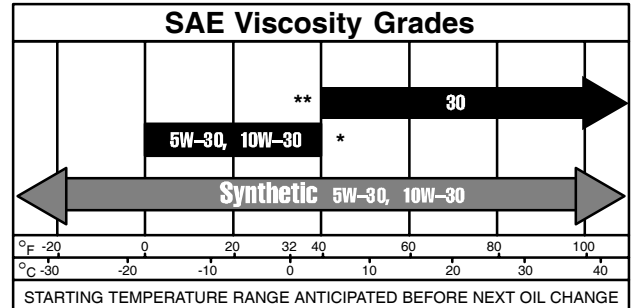

- * **CAUTION:** Air cooled engines run hotter than automotive engines. The use of non-synthetic multi-viscosity oils (5W-30, 10W-30, etc.) in temperatures above 40° F (4° C) will result in higher than normal oil consumption. When using a multi-viscosity oil, check oil level more frequently.
- ** **CAUTION:** SAE 30 oil, if used below 40° F (4° C), will result in hard starting and possible engine bore damage due to inadequate lubrication.

CHECKING AND ADDING OIL

- Check oil level *before* starting the engine.
- Check level daily, or after every eight (8) hours.
- Keep oil level at FULL.
- Do not overfill.

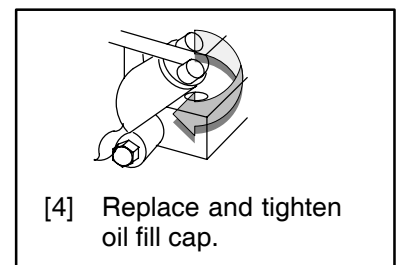
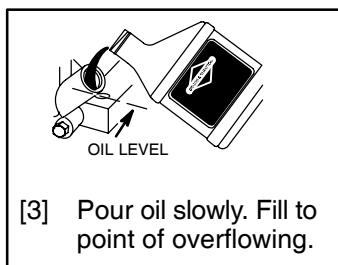
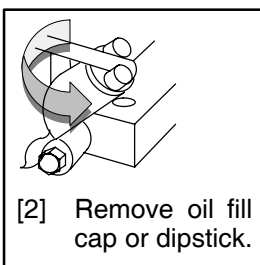
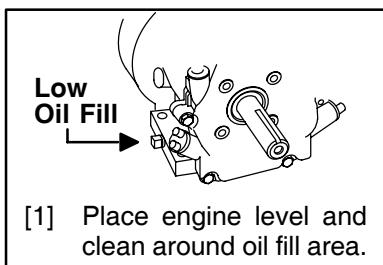
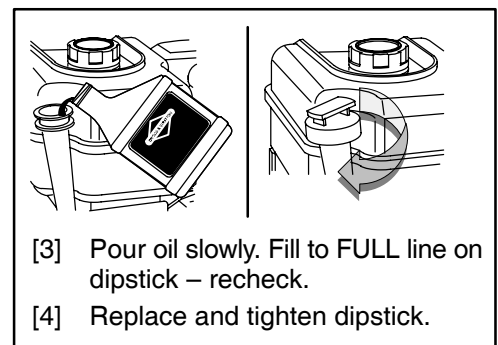
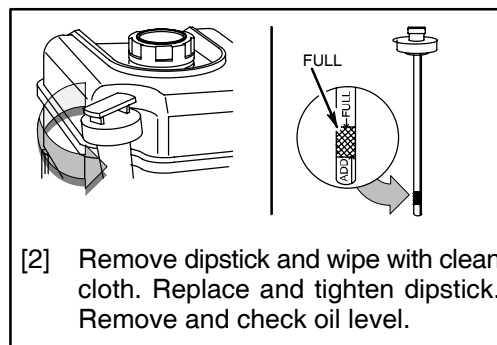
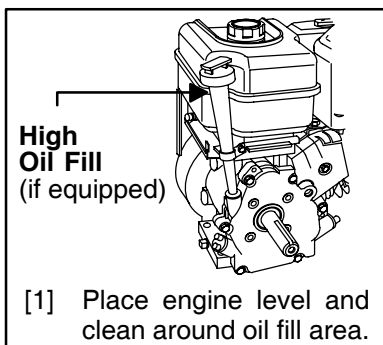

OIL



BRIGGS & STRATTON

CHECKING AND ADDING OIL

Low Oil Fill with Dipstick

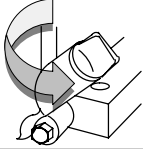

[1] Remove dipstick and wipe with clean cloth.

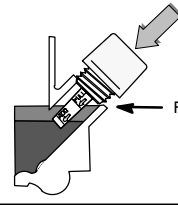
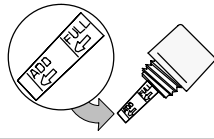

[2] Insert dipstick, but **DO NOT TIGHTEN**. Remove and check oil level.

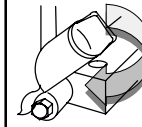

[3] Pour oil slowly. Fill to **FULL** mark on dipstick. Replace and tighten dipstick.

FUEL



BRIGGS & STRATTON

TYPE OF FUEL TO USE

- Use clean, fresh, regular unleaded gasoline with a minimum of 85 octane. Fresh fuel prevents gum from forming in the fuel system or on essential carburetor parts. Purchase fuel in quantity that can be used within 30 days.
- Do not use gasoline which contains Methanol.
- Do not mix oil with gasoline.
- For engine protection use Briggs & Stratton Gasoline Additive available from your Authorized Briggs & Stratton Dealer (P/N 5041 or single use pouch).

- This engine is certified to operate on gasoline. Exhaust Emission Control System: EM (Engine Modifications).

CAUTION: Some fuels, called oxygenated or reformulated gasoline, are gasoline blended with alcohols or ethers. Excessive amounts of these blends can damage the fuel system or cause performance problems. If any undesirable operating symptoms occur, use gasoline with a lower percentage of alcohol or ether.

ADDING FUEL

WARNING



- Turn engine **OFF** and let engine cool at least 2 minutes before removing gas cap.
- Fill fuel tank outdoors or in well-ventilated area.
- Keep gasoline away from sparks, open flames, pilot lights, heat, and other ignition sources.
- If fuel spills, wait until it evaporates before starting engine.

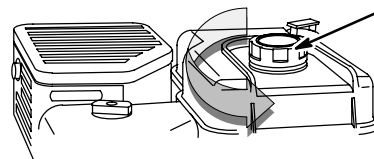

Fuel Fill

- [1] Remove cap. Fill tank to approximately 1-1/2 inches below top of neck to allow for fuel expansion. Be careful not to overfill. Briggs & Stratton **Smart-fill®** fuel can fills to the correct level and automatically shuts off, reducing spills and emissions.
- [2] Replace cap before starting.

STARTING

BRIGGS & STRATTON

STARTING AND OPERATING TIPS

- ◆ Store and fuel equipment in level position.
- ◆ Use fresh fuel. (See Fuel.)
- ◆ Use correct type of oil for expected starting temperature. (See Oil.)
- ◆ Remove external equipment/engine loads. (See equipment operating instructions.)
- ◆ Periodically remove any debris buildup from the machine (See Maintenance.)
- ◆ After engine has started, let it warm up several seconds to several minutes, depending on outside temperature.
- ◆ For maximum performance and life, operate engine with choke in **RUN** and throttle in **FAST**.



STARTING AND STOPPING

WARNING



- Do not use pressurized starting fluids.
- Vapors are flammable.

CAUTION: Some engines may be equipped with **OIL GARD®**. The **OIL GARD®** is intended to warn the operator that the engine is low on oil. Always check oil level before starting. Engine damage may occur if the oil level is not properly maintained and will void warranty coverage. If the engine will not start, has stopped running and/or a light flickers in the stop switch, add oil (see instructions).

REWIND (MANUAL) STARTER TO START ENGINE

[1] Check oil level (see p. 7).

Fuel shut-off

[2] Turn fuel shut-off valve (if equipped) 1/4 turn to OPEN.

Choke

[3] Push choke lever to CHOKE position.

[4] Move throttle (if equipped) to FAST. Operate engine with throttle in FAST.

[5] Push rocker switch (if equipped) to ON.

WARNING

[6] Grasp rope handle. Pull slowly until resistance is felt, then pull rapidly to start engine and avoid kickback.

[7] Let engine warm up. **If choke equipped:** Slowly adjust toward RUN position. Wait until engine runs smoothly before each choke adjustment.

TO STOP ENGINE

CAUTION: Do not stop engine by moving choke control to CHOKE. Backfire, fire or engine damage could occur.

[1] Move throttle (if equipped) to SLOW, then to STOP.

[2] Push rocker switch (if equipped) to OFF.

Fuel shut-off

[3] Close fuel shut-off valve (if equipped).

STARTING AND STOPPING

BRIGGS & STRATTON

ELECTRIC (KEY) STARTER (if equipped) TO START ENGINE

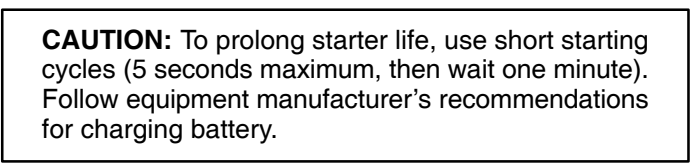
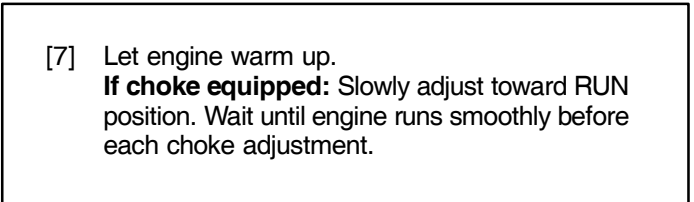
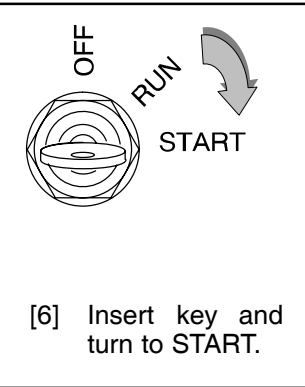
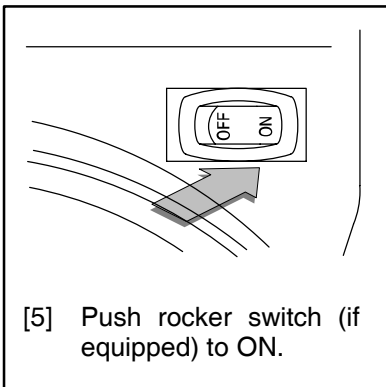
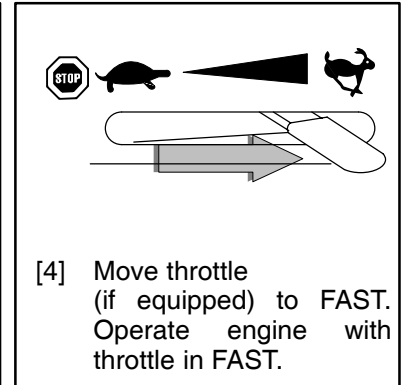
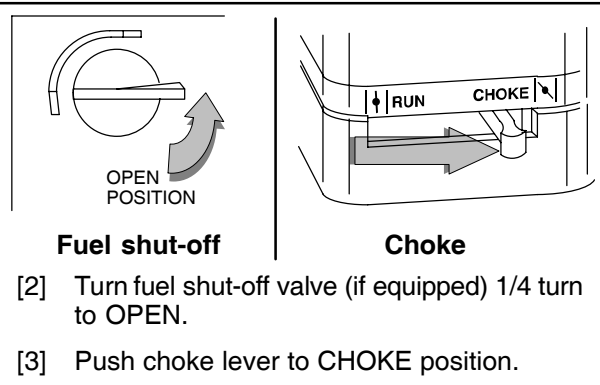
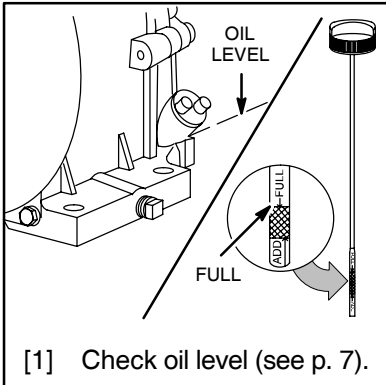

TO STOP ENGINE

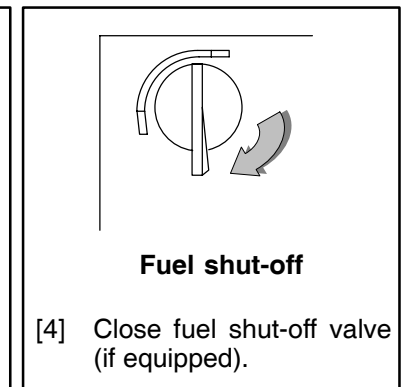
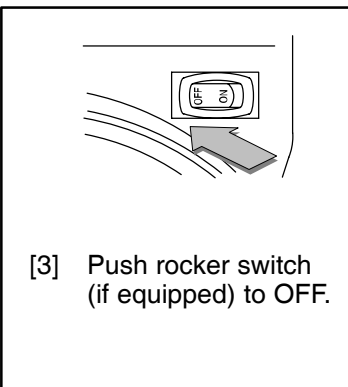
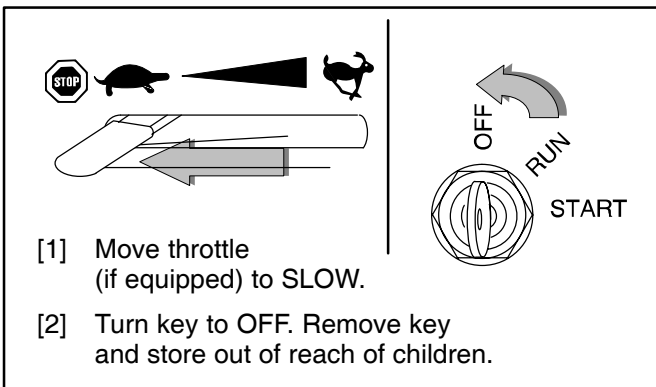



ENGINE AND ENGINE PARTS

We recommend that you see an authorized Briggs & Stratton Service Dealer for all maintenance and service of the engine and engine parts. Use only genuine Briggs & Stratton parts.



If you perform any maintenance on the engine, first disconnect the spark plug wire from the spark plug, and disconnect the battery at the negative terminal (electric starter engines only) to prevent unintentional sparking. Unintentional sparking can result in fire or electric shock. Unintentional start-up can result in entanglement, traumatic amputation or laceration. Use only correct tools.



- Do not strike the flywheel with a hammer or hard object because the flywheel may later shatter during operation.
- Do not tamper with governor spring, links or other parts to increase engine speed.

MUFFLER



Replacement parts for the muffler must be the same and installed in the same position as the original parts, otherwise fire can occur.

If muffler is equipped with spark arrester screen, remove screen for inspection. Replace screen if damaged or plugged.

SPARK PLUG

Use only Briggs & Stratton Spark Tester (part number 19368) to check for spark.

Note: In some areas, local law requires using resistor spark plug to suppress ignition signals. If this engine was originally equipped with resistor spark plug, use same type for replacement.

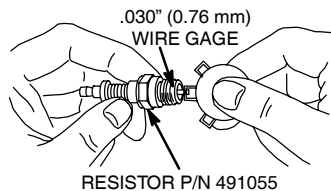

FUEL SYSTEM



Replacement parts for fuel system (cap, hoses, tanks, filters, etc.) must be the same as original parts, otherwise fire can occur.

REPLACE FUEL FILTER (if equipped)

Drain fuel tank or close fuel shut-off valve before replacing fuel filter. Otherwise, fuel can leak out, creating a fire/explosion hazard.

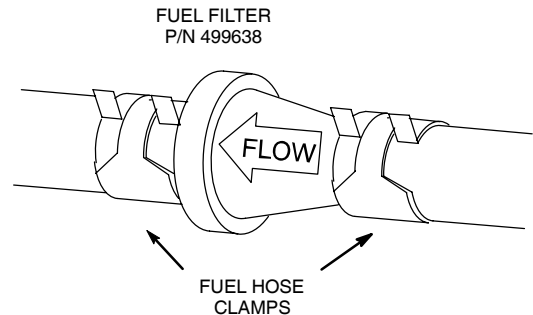

MAINTENANCE



CLEANING DEBRIS

CAUTION: Do not use water to clean engine parts. Water could contaminate fuel system. Use a brush or dry cloth.

Daily or before every use, clean accumulated debris from engine. Keep linkage, spring and controls clean. Keep area around and behind muffler free of any combustible debris.

WARNING



Engine parts should be kept clean to reduce the risk of overheating and ignition of accumulated debris.

**Finger Guard,
Linkage, Springs,
Controls,
Muffler and
Spark Arrester**

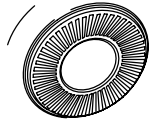

CLEAN



PARTIAL LIST OF GENUINE BRIGGS & STRATTON PARTS

| <u>PART</u> | <u>BRIGGS & STRATTON PART NUMBER</u> |
|--|--|
| Flat air cleaner cartridge | 491588 -OR- 5043 |
| Flat air cleaner pre-cleaner | 493537 -OR- 5064 |
| Model Series 110000 / 120000 | |
| Oval air cleaner cartridge | 690610 -OR- 5059 |
| Oval pre-cleaner | 273356 -OR- 5059 |
| Model Series 200000 / 210000 | |
| Oval air cleaner cartridge | 695302 |
| Oval pre-cleaner | 695303 |
| Oil foam air cleaner pre-cleaner | 273332 |
| Oil | 100005 -OR- 100028 |
| Fuel filter | 694485 |
| Gas additive | 5041 |
| Resistor spark plug | 491055 |
| Long life platinum spark plug (used on most OHV engines) | 5066 |
| Spark plug wrench | 89838 -OR- 5023 |
| Spark tester | 19368 |
| Oil pump kit (uses standard electric drill to remove oil from engine quickly) | 5056 |

SERVICE

See an Authorized Briggs & Stratton Service Dealer. Each one carries a stock of Genuine Briggs & Stratton Parts and is equipped with special service tools. Trained mechanics assure expert repair service on all Briggs & Stratton engines. Only dealers advertising as "Authorized Briggs & Stratton" are required to meet Briggs & Stratton standards.

When you purchase equipment powered by a Briggs & Stratton engine, you are assured of highly skilled, reliable service at more than 30,000 Authorized Service Dealers worldwide, including more than 6,000 Master Service Technicians. Look for these signs wherever Briggs & Stratton service is offered.



STORAGE

Engines stored over 30 days need special attention.

- [1] To prevent gum from forming in fuel system or on essential carburetor parts:
- a) if fuel tank contains oxygenated or reformulated gasoline (gasoline blended with an alcohol or an ether), run engine until it stops from lack of fuel, **or** b) if fuel tank contains gasoline, either run engine until it stops from lack of fuel, or add a gasoline additive to the gas in the tank. (See parts list. Single – use pouches of gas additive are available from your service dealer.) If you use a gas additive, run the engine for several minutes to circulate the additive through the carburetor. Then, engine and fuel can be stored up to 24 months.

- [2] While engine is still warm, change oil.

- [3] Remove spark plug and pour about 1 oz. (30 ml) of engine oil into cylinder. Replace spark plug and crank slowly to distribute oil.

- [4] Clean engine of surface debris, chaff or grass.



- [5] Store in a clean, dry area. Do not store in same area as a stove, furnace, water heater, or other appliance that uses a pilot light or has a device that can create a spark.

BRIGGS & STRATTON ENGINE OWNER WARRANTY POLICY

Effective July 1, 2004 replaces all undated Warranties and all Warranties dated before July 1, 2004.

LIMITED WARRANTY

Briggs & Stratton Corporation will repair or replace, free of charge, any part(s) of the engine that is defective in material or workmanship or both. Transportation charges on parts submitted for repair or replacement under this warranty must be borne by purchaser. This warranty is effective for the time periods and subject to the conditions stated below. For warranty service, find the nearest Authorized Service Dealer in our dealer locator map at www.briggsandstratton.com, or by calling 1-800-233-3723, or as listed in the 'Yellow Pages'™.

THERE IS NO OTHER EXPRESS WARRANTY. IMPLIED WARRANTIES, INCLUDING THOSE OF MERCHANTABILITY AND FITNESS FOR A PARTICULAR PURPOSE, ARE LIMITED TO ONE YEAR FROM PURCHASE, OR TO THE EXTENT PERMITTED BY LAW ANY AND ALL IMPLIED WARRANTIES ARE EXCLUDED. LIABILITY FOR INCIDENTAL OR CONSEQUENTIAL DAMAGES ARE EXCLUDED TO THE EXTENT EXCLUSION IS PERMITTED BY LAW. Some states or countries do not allow limitations on how long an implied warranty lasts, and some states or countries do not allow the exclusion or limitation of incidental or consequential damages, so the above limitation and exclusion may not apply to you. This warranty gives you specific legal rights and you may also have other rights which vary from state to state and country to country.

OUR ENGINE

| | | | | |
|------------------|---|--|-----------------|--------------|
| Vanguard™ | ELS™ I/C® Industrial Plus™ Intek™ (Sleeve Bore) | Fource™ Intek™ (Kool Bore) Power Built™ OHV Quantum® Quattro™ Q45™ Sprint™ | Classic™ | Etek™ |
|------------------|---|--|-----------------|--------------|

WARRANTY PERIOD*

| | | | | | |
|----------------|---------|---------|---------|---------|--------|
| Consumer Use | 2 years | 2 years | 2 years | 1 year | 1 year |
| Commercial Use | | 1 year | 90 days | 90 days | |

* **Note the following special warranty periods: 2 years** for Classic™ engines in the European Union and Eastern European countries, for all consumer products in the European Union, and for emission control systems on engines certified by EPA and CARB. **5 years** for Consumer use, **90 days** for Commercial use of Touch-N-Mow® starter on Quantum® and Intek™ engines. **One year** for Consumer use, **90 days** for Commercial use on engines certified to operate on Kerosene fuel. Engines used on Home Standby Generator applications are warranted under Consumer use only. This warranty does not apply to engines on equipment used for prime power in place of a utility. **Engines used in competitive racing or on commercial or rental tracks are not warranted.**

The warranty period begins on the date of purchase by the first retail consumer or commercial end user, and continues for the period of time stated in the table above. "Consumer use" means personal residential household use by a retail consumer. "Commercial use" means all other uses, including use for commercial, income producing or rental purposes. Once an engine has experienced commercial use, it shall thereafter be considered as a commercial use engine for purposes of this warranty.

NO WARRANTY REGISTRATION IS NECESSARY TO OBTAIN WARRANTY ON BRIGGS & STRATTON PRODUCTS. SAVE YOUR PROOF OF PURCHASE RECEIPT. IF YOU DO NOT PROVIDE PROOF OF THE INITIAL PURCHASE DATE AT THE TIME WARRANTY SERVICE IS REQUESTED, THE MANUFACTURING DATE OF THE PRODUCT WILL BE USED TO DETERMINE THE WARRANTY PERIOD.

ABOUT YOUR ENGINE WARRANTY

Briggs & Stratton welcomes warranty repair and apologizes to you for being inconvenienced. Any Authorized Service Dealer may perform warranty repairs. Most warranty repairs are handled routinely, but sometimes requests for warranty service may not be appropriate. For example, warranty would not apply if engine damage occurred because of misuse, lack of routine maintenance, shipping, handling, warehousing or improper installation. Similarly, warranty is void if the serial number of the engine has been removed or the engine has been altered or modified.

If a customer differs with the decision of the Service Dealer, an investigation will be made to determine whether the warranty applies. Ask the Service Dealer to submit all supporting facts to his Distributor or the Factory for review. If the Distributor or the Factory decides that the claim is justified, the customer will be fully reimbursed for those items that are defective. To avoid misunderstanding which might occur between the customer and the Dealer, listed below are some of the causes of engine failure that the warranty does not cover.

Normal wear:

Engines, like all mechanical devices, need periodic parts service and replacement to perform well. Warranty will not cover repair when normal use has exhausted the life of a part or an engine.

Improper maintenance:

The life of an engine depends upon the conditions under which it operates, and the care it receives. Some applications, such as tillers, pumps and rotary mowers, are very often used in dusty or dirty conditions, which can cause what appears to be premature wear. Such wear, when caused by dirt, dust, spark plug cleaning grit, or other abrasive material that has entered

the engine because of improper maintenance, is not covered by warranty.

This warranty covers engine related defective material and/or workmanship only, and not replacement or refund of the equipment to which the engine may be mounted. Nor does the warranty extend to repairs required because of:

1. PROBLEMS CAUSED BY PARTS THAT ARE NOT ORIGINAL BRIGGS & STRATTON PARTS.
2. Equipment controls or installations that prevent starting, cause unsatisfactory engine performance, or shorten engine life. (Contact equipment manufacturer.)
3. Leaking carburetors, clogged fuel pipes, sticking valves, or other damage, caused by using contaminated or stale fuel. (Use clean, fresh, lead-free gasoline and Briggs & Stratton Fuel Stabilizer, Part No. 5041.)
4. Parts which are scored or broken because an engine was operated with insufficient or contaminated lubricating oil, or an incorrect grade of lubricating oil (check oil level daily or after every 8 hours of operation. Refill when necessary and change at recommended intervals.) OIL GARD® may not shut down running engine. Engine damage may occur if oil level is not properly maintained. Read Operating & Maintenance Instructions.
5. Repair or adjustment of associated parts or assemblies such as clutches, transmissions, remote controls, etc., which are not manufactured by Briggs & Stratton.
6. Damage or wear to parts caused by dirt, which entered the engine because of improper air cleaner maintenance, re-assembly, or use of a non-original air cleaner element or cartridge. (At recommended

intervals, clean and re-oil the Oil-Foam® element or the foam pre-cleaner, and replace the cartridge.) Read Operating & Maintenance Instructions.

7. Parts damaged by over-speeding, or overheating caused by grass, debris, or dirt, which plugs or clogs the cooling fins, or flywheel area, or damage caused by operating the engine in a confined area without sufficient ventilation. (Clean fins on the cylinder, cylinder head and flywheel at recommended intervals.) Read Operating & Maintenance Instructions.
8. Engine or equipment parts broken by excessive vibration caused by a loose engine mounting, loose cutter blades, unbalanced blades or loose or unbalanced impellers, improper attachment of equipment to engine crankshaft, over-speeding or other abuse in operation.
9. A bent or broken crankshaft, caused by striking a solid object with the cutter blade of a rotary lawn mower, or excessive v-belt tightness.
10. Routine tune-up or adjustment of the engine.
11. Engine or engine component failure, i.e., combustion chamber, valves, valve seats, valve guides, or burned starter motor windings, caused by the use of alternate fuels such as, liquified petroleum, natural gas, altered gasolines, etc.

Warranty service is available only through service dealers which have been authorized by Briggs & Stratton Corporation. Your nearest Authorized Service Dealer is listed in the "Yellow Pages"™ of your telephone directory under "Engines, Gasoline" or "Gasoline Engines," "Lawn Mowers," or similar category.

**Briggs & Stratton Corporation (B&S), the California Air Resources Board (CARB)
and the United States Environmental Protection Agency (U.S. EPA)
Emissions Control System Warranty Statement (Owner's Defect Warranty Rights and Obligations)**

The California Air Resources Board (CARB), U.S. EPA and B&S are pleased to explain the Emissions Control System Warranty on your small off-road engine (SORE). In California, new small off-road engines model year 2006 and later must be designed, built and equipped to meet the State's stringent anti-smog standards.

Elsewhere in the United States, new non-road,

spark-ignition engines certified for model year 1997 and later must meet similar standards set forth by the U.S. EPA. B&S must warrant the emissions control system on your engine for the periods of time listed below, provided there has been no abuse, neglect or improper maintenance of your small off-road engine.

Your emissions control system includes parts

such as the carburetor, air cleaner, ignition system, fuel line, muffler and catalytic converter. Also included may be connectors and other emissions related assemblies.

Where a warrantable condition exists, B&S will repair your small off-road engine at no cost to you including diagnosis, parts and labor.

Briggs & Stratton Emissions Control Defects Warranty Coverage

Small off-road engines are warranted relative to emissions control parts defects for a period of two years, subject to provisions set forth below. If any covered part on your engine is defective, the part will be repaired or replaced by B&S.

Owner's Warranty Responsibilities

As the small off-road engine owner, you are responsible for the performance of the required maintenance listed in your Operating and Maintenance Instructions. B&S recommends that you retain all your receipts covering maintenance on your small off-road engine, but B&S cannot deny warranty solely for the lack of receipts or for your failure to ensure the performance of all scheduled maintenance.

As the small off-road engine owner, you should

however be aware that B&S may deny you warranty coverage if your small off-road engine or a part has failed due to abuse, neglect, improper maintenance or unapproved modifications.

You are responsible for presenting your small off-road engine to an Authorized B&S Service Dealer as soon as a problem exists.

The undisputed warranty repairs should be completed in a reasonable amount of time, not

to exceed 30 days.

If you have any questions regarding your warranty rights and responsibilities, you should contact a B&S Service Representative at 1-414-259-5262.

The emissions warranty is a defects warranty. Defects are judged on normal engine performance. The warranty is not related to an in-use emissions test.

Briggs & Stratton Emissions Control Defects Warranty Provisions

The following are specific provisions relative to your emissions Control Defects Warranty Coverage. It is in addition to the B&S engine warranty for non-regulated engines found in the Operating and Maintenance Instructions.

1. **Warranted Parts**
Coverage under this warranty extends only to the parts listed below (the emissions control systems parts) to the extent these parts were present on the engine purchased.
 - a. **Fuel Metering System**
 - Cold start enrichment system
 - Carburetor and internal parts
 - Fuel Pump
 - Fuel line, fuel line fittings, clamps
 - b. **Air Induction System**
 - Air cleaner
 - Intake manifold
 - c. **Ignition System**
 - Spark plug(s)
 - Magneto ignition system
 - d. **Catalyst System**
 - Catalytic converter
 - Exhaust manifold
 - Air injection system, Pulse valve
 - e. **Miscellaneous Items**
 - Vacuum, temperature, position, time sensitive valves and switches
 - Connectors and assemblies
2. **Length of Coverage**
B&S warrants to the initial owner and each

- subsequent purchaser that the Warranted Parts shall be free from defects in materials and workmanship which caused the failure of the Warranted Parts for a period of two years from the date the engine is delivered to a retail purchaser.
3. **No Charge**
Repair or replacement of any Warranted Part will be performed at no charge to the owner, including diagnostic labor which leads to the determination that a Warranted Part is defective, if the diagnostic work is performed at an Authorized B&S Service Dealer. For emissions warranty service contact your nearest Authorized B&S Service Dealer as listed in the "Yellow Pages" under "Engines, Gasoline," "Gasoline Engines," "Lawn Mowers," or similar category.
4. **Claims and Coverage Exclusions**
Warranty claims shall be filed in accordance with the provisions of the B&S Engine Warranty Policy. Warranty coverage shall be excluded for failures of Warranted Parts which are not original B&S parts or because of abuse, neglect or improper maintenance as set forth in the B&S Engine Warranty Policy.

- B&S is not liable to cover failures of Warranted Parts caused by the use of add-on, non-original, or modified parts.
5. **Maintenance**
Any Warranted Part which is not scheduled for replacement as required maintenance or which is scheduled only for regular inspection to the effect of "repair or replace as necessary" shall be warranted as to defects for the warranty period. Any Warranted Part which is scheduled for replacement as required maintenance shall be warranted as to defects only for the period of time up to the first scheduled replacement for that part. Any replacement part that is equivalent in performance and durability may be used in the performance of any maintenance or repairs. The owner is responsible for the performance of all required maintenance, as defined in the B&S Operating and Maintenance Instructions.
6. **Consequential Coverage**
Coverage hereunder shall extend to the failure of any engine components caused by the failure of any Warranted Part still under warranty.

| Briggs & Stratton Engines Are Made Under One Or More Of The Following Patents: Design D-247,177 (Other Patents Pending) | | | | | | | | | | |
|---|-----------|-----------|-----------|-----------|-----------|-----------|-----------|-----------|-----------|-----------|
| 6,691,683 | 6,520,141 | 6,325,036 | 6,145,487 | 6,012,420 | 5,803,035 | 5,548,955 | 5,243,878 | 5,138,996 | 4,875,448 | D 476,629 |
| 6,647,942 | 6,495,267 | 6,311,663 | 6,142,257 | 5,992,367 | 5,765,713 | 5,546,901 | 5,235,943 | 5,086,890 | 4,819,593 | D 457,891 |
| 6,622,683 | 6,494,175 | 6,284,123 | 6,135,426 | 5,904,124 | 5,732,555 | 5,445,014 | 5,234,038 | 5,070,829 | 4,720,638 | D 368,187 |
| 6,615,787 | 6,472,790 | 6,263,852 | 6,116,212 | 5,894,715 | 5,645,025 | 5,503,125 | 5,228,487 | 5,058,544 | 4,719,682 | D 375,963 |
| 6,617,725 | 6,460,502 | 6,260,529 | 6,105,548 | 5,887,678 | 5,642,701 | 5,501,203 | 5,197,426 | 5,040,644 | 4,633,556 | D 309,457 |
| 6,603,227 | 6,456,515 | 6,242,828 | 6,347,614 | 5,852,951 | 5,628,352 | 5,497,679 | 5,197,425 | 5,009,208 | 4,630,498 | D 372,871 |
| 6,595,897 | 6,382,166 | 6,239,709 | 6,082,323 | 5,843,345 | 5,619,845 | 5,320,795 | 5,197,422 | 4,996,956 | 4,522,080 | D 361,771 |
| 6,595,176 | 6,369,532 | 6,237,555 | 6,077,063 | 5,823,153 | 5,606,948 | 5,301,643 | 5,191,864 | 4,977,879 | 4,520,288 | D 356,951 |
| 6,584,964 | 6,356,003 | 6,230,678 | 6,064,027 | 5,819,513 | 5,606,851 | 5,271,363 | 5,188,069 | 4,977,877 | 4,512,499 | D 309,457 |
| 6,557,833 | 6,349,688 | 6,213,083 | 6,040,767 | 5,813,384 | 5,605,130 | 5,269,713 | 5,186,142 | 4,971,219 | 4,453,507 | D 308,872 |
| 6,542,074 | 6,347,614 | 6,202,616 | 6,014,808 | 5,809,958 | 5,497,679 | 5,265,700 | 5,150,674 | 4,895,119 | 4,430,984 | D 308,871 |

(Cette page ne s'applique que pour le Canada et les États-Unis)

Déclaration de garantie pour les défauts de contrôle d'émissions pour la Californie, les États-Unis et le Canada.

Le California Air Resources Board (CARB), U.S. EPA et B&S ont le plaisir de vous expliquer la garantie du système de contrôle des émissions pour votre petit moteur tout terrain. En Californie, les petits moteurs tout terrain à partir de l'année 2006 doivent être conçus, fabriqués et équipés pour répondre aux normes sévères antibrouillard de l'état. Ailleurs aux États-Unis, les nouveaux moteurs tout terrain à allumage commandé par bougie depuis l'année 1997 doivent répondre à des normes semblables édictées par la U.S. EPA. B&S doit garantir le système de contrôle des émissions de votre moteur pendant les durées indiquées ci-après, en supposant que le petit

moteur tout terrain ne soit pas mal utilisé, négligé ou que son entretien ne soit pas défectueux. Le système de contrôle des émissions comprend des pièces comme le carburateur, le filtre à air, le système d'allumage, la Durit de carburant, le silencieux et le convertisseur catalytique. Des connecteurs et d'autres assemblages impliqués dans les émissions peuvent aussi en faire partie. Si la condition de garantie est remplie, Briggs & Stratton réparera gratuitement votre moteur y compris le diagnostic, les pièces et la main-d'œuvre.

Couverture de la garantie de défektivité du contrôle des émissions de Briggs & Stratton

Les petits moteurs tout terrain sont garantis en ce qui concerne les défauts des pièces du contrôle d'émission pendant une période de deux ans, aux conditions énoncées plus loin. Si une pièce de votre moteur couverte par cette garantie est défectueuse, Briggs et Stratton la réparera ou la remplacera.

Responsabilités du propriétaire au titre de la garantie

En tant que propriétaire d'un petit moteur non routier, vous êtes responsable de l'entretien nécessaire indiqué dans les instructions de fonctionnement et d'entretien. Briggs & Stratton recommande de conserver toutes les factures de maintenance de votre moteur, mais Briggs & Stratton ne peut renier la garantie uniquement à cause de l'absence de factures.



BRIGGS & STRATTON

