

# OWNER'S GUIDE

FIFTY CENTS

**MODEL  
NO.  
129-270A**

**ASSEMBLY  
OPERATION  
PARTS  
MAINTENANCE**

**22"  
SELF PROPELLED  
ROTARY  
MOWER**

**IMPORTANT:  
READ SAFETY RULES  
& INSTRUCTIONS**

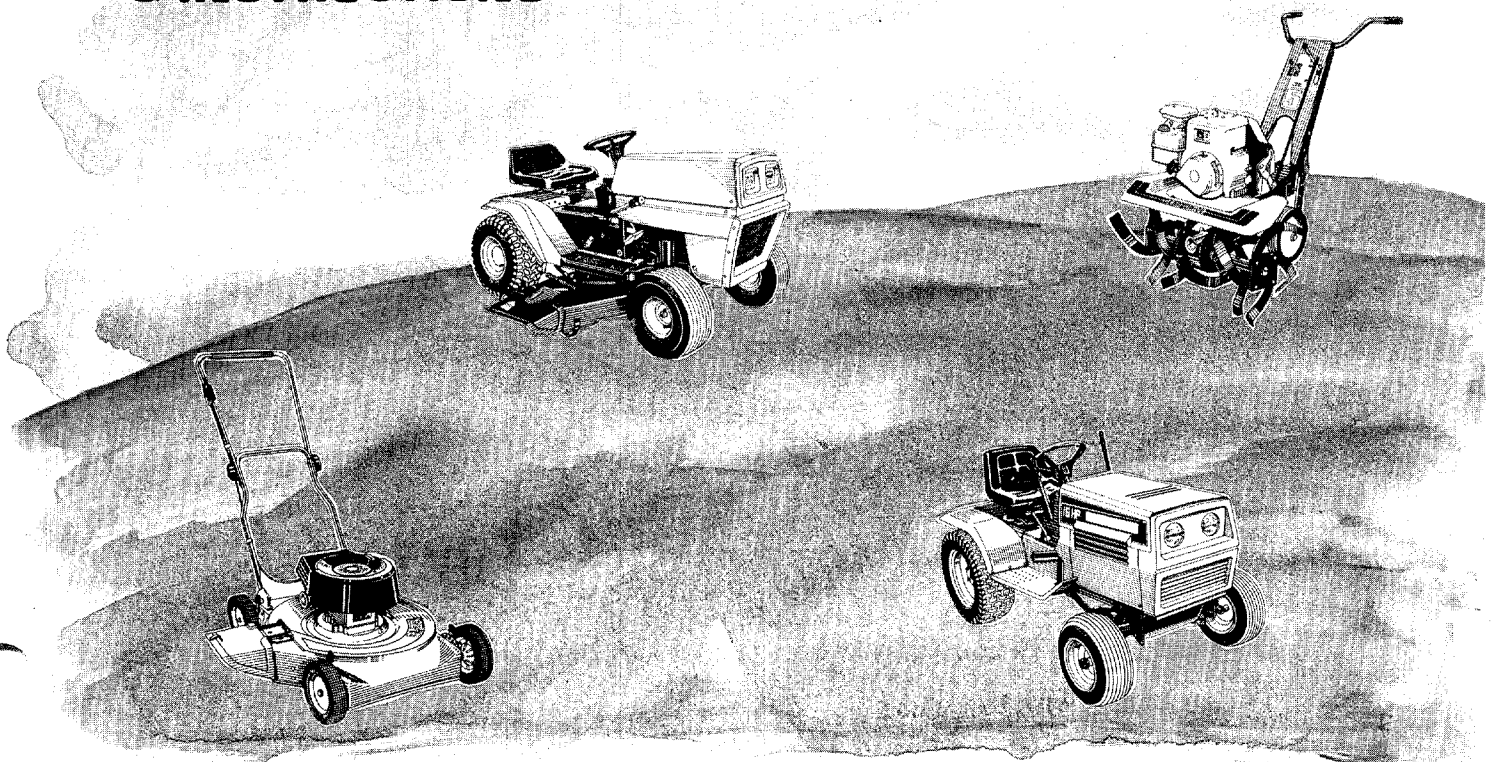

## LIMITED WARRANTY

For one year from the date of original retail purchase, MTD PRODUCTS INC will either repair or replace, at its option, free of charge, F.O.B. factory or authorized service firm, any part or parts found to be defective in material or workmanship. Transportation charges under this warranty must be paid by the purchaser unless return is requested by MTD PRODUCTS INC.

This warranty will not apply to any part which has become inoperative due to misuse, excessive use, accident, neglect, improper maintenance, alterations, or unless the unit has been operated and maintained in accordance with the instructions furnished. This warranty does not apply to the engine, motor, battery, battery charger or component parts thereof. Please refer to the applicable manufacturer's warranty on these items.

This warranty will not apply where the unit has been used commercially.

Warranty service is available through your local authorized service dealer or distributor. If you do not know the dealer or distributor in your area, please write to the Customer Service Department of MTD.

The return of a complete unit will not be accepted by the factory unless prior written permission has been extended by MTD.

This warranty gives you specific legal rights. You may also have other rights which vary from state to state.

### WARNING TO PURCHASERS OF INTERNAL COMBUSTION ENGINE EQUIPPED MACHINERY OR DEVICES IN THE STATE OF CALIFORNIA

The equipment which you have just purchased does not have a spark arrester. If this equipment is used on any forest covered land, brush covered land, or grass covered unimproved land in the State of California, before using on such land, the California law requires that a spark arrester be provided. In addition, spark arrester is required by law to be in effective working order. The spark arrester must be attached to the exhaust system and comply with Section 4442 of the California Public Resources Code.

# **IMPORTANT**

It is suggested that this manual be read in its entirety before attempting to assemble or operate. Keep this manual in a safe place for future reference and for ordering replacement parts.

This unit is shipped WITHOUT GASOLINE or OIL. After assembly, see operating section of this manual for proper fuel and amount.

Your rotary mower is a precision piece of power equipment, not a plaything. Therefore exercise extreme caution at all times.

## **SAFE OPERATION PRACTICES FOR WALK-BEHIND MOWERS**

### **TRAINING**

1. Read the Operating and Service Owner's Manual carefully. Be thoroughly familiar with the controls and the proper use of the equipment.
2. Never allow children to operate a power mower. Only persons well acquainted with these rules of safe operation should be allowed to use your mower.
3. Keep the area of operation clear of all persons, particularly small children and pets. Stop engine when they are in the vicinity of your mower. Although the area of operation should be completely cleared of foreign objects, a small object may have been overlooked and could be accidently thrown by the mower in any direction.

### **PREPARATION**

1. Thoroughly inspect the area where the equipment is to be used and remove all stones, sticks, wire, bones and other foreign objects which could be picked up and thrown by the mower in any direction.
2. Do not operate equipment when barefoot or wearing open sandals. Always wear substantial footwear.
3. Do not wear loose fitting clothing that could get caught on the mower.
4. Check the fuel before starting the engine. Do not fill the gasoline tank indoors, when the engine is running, or while the engine is still hot. Wipe off any spilled gasoline before starting the engine.
5. Disengage the self-propelled mechanism or drive clutch on units so equipped before starting the engine.
6. Never attempt to make a wheel or cutting height adjustment while the engine is running.
7. Mow only in daylight or in good artificial light.
8. Never operate the equipment in wet grass. Always be sure of your footing; keep a firm hold on the handle and walk, never run.

### **OPERATION**

1. Do not change the engine governor settings or overspeed the engine. Excessive engine speeds are dangerous.
2. Do not put hands or feet near or under rotating parts. Keep clear of the discharge opening at all times.
3. Stop the blade(s) when crossing gravel drive, walks or roads.
4. After striking a foreign object, stop the engine, remove the wire from the spark plug,

thoroughly inspect the mower for any damage, and repair the damage before restarting and operating the mower.

5. If the equipment should start to vibrate abnormally, stop the engine and check immediately for the cause. Vibration is generally a warning of trouble.
6. Stop the engine whenever you leave the mower, before cleaning the mower housing, and when making any repairs or inspections.
7. When cleaning, repairing or inspecting, make certain the blade and all moving parts have stopped. Disconnect the spark plug wire, and keep the wire away from the plug to prevent accidental starting.
8. Before attempting to unclog the mower or discharge chute, stop the engine and be sure the blade(s) have stopped completely. Disconnect the spark plug wire and keep the wire away from the plug to prevent accidental starting.
9. Do not run the engine indoors.
10. Shut the engine off and wait until the blade comes to a complete stop before removing the grass catcher.
11. Mow across the face of slopes, never up-and-down. Exercise extreme caution when changing direction on slopes. Do not mow excessively steep slopes.
12. Always disconnect electric mowers (line operated) before cleaning, repairing or adjusting.
13. Never operate mower without proper guards, plates or other safety protective devices in place.
14. Keep washout ports and other mower-housing service openings closed when mowing.

### **MAINTENANCE AND STORAGE**

1. Check the blade and engine mounting bolts at frequent intervals for proper tightness.
2. Keep all nuts, bolts, and screws tight to be sure the equipment is in safe working condition.
3. Never store the equipment with gasoline in the tank inside of a building where fumes may reach an open flame or spark. Allow the engine to cool before storing in any enclosure.
4. To reduce fire hazard, keep the engine free of grass, leaves, or excessive grease.
5. Check the grass catcher bag frequently for wear or deterioration. For safety protection replace only with new bag meeting original equipment specifications.

# HANDLE ASSEMBLY



**NOTE:** Follow instructions starting with Number 1 and continue through Number 6.



**NOTE:**

It may be necessary to spread the ends of the lower handle outward slightly to assure a snug fit against the bracket mounting area.

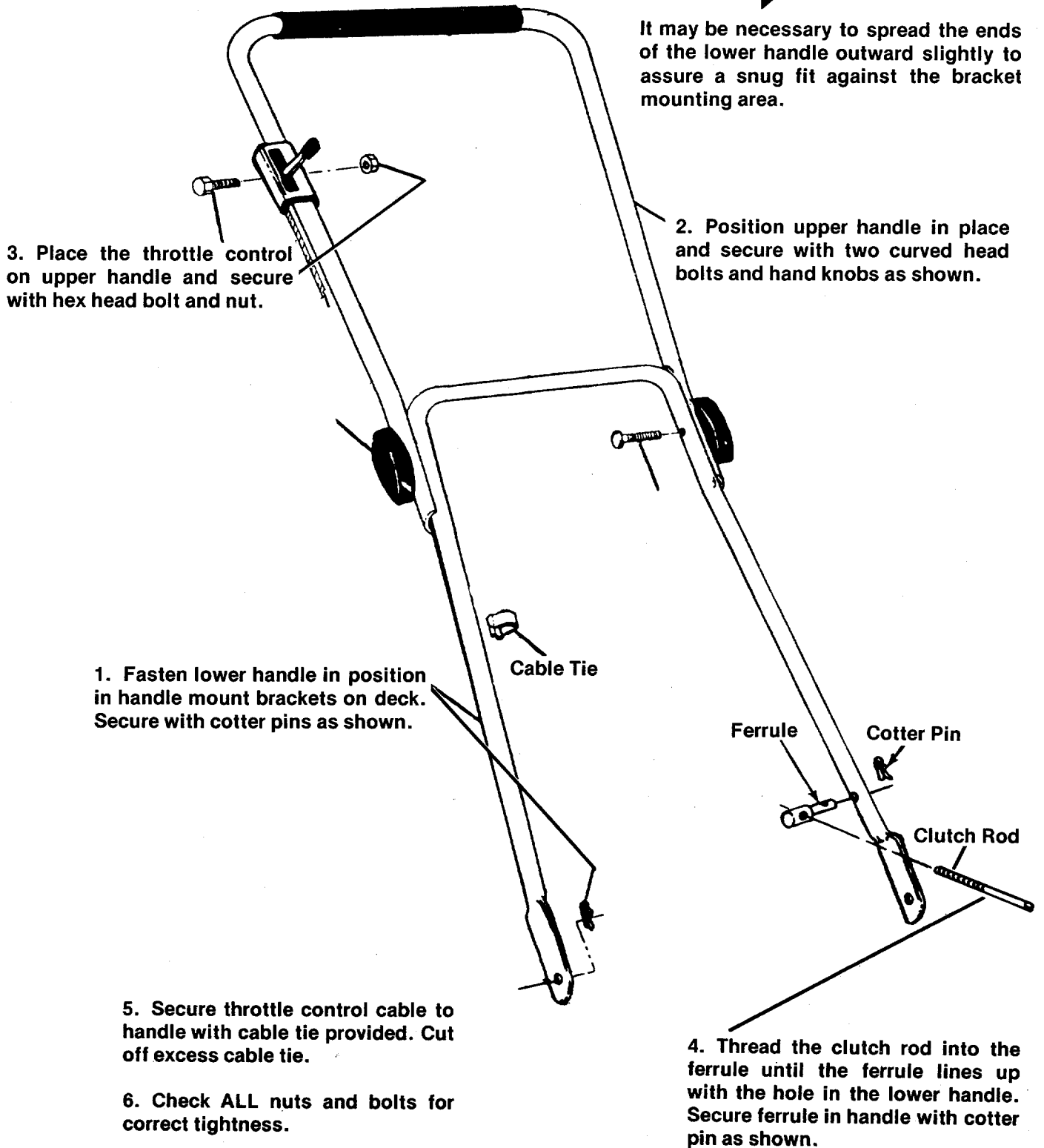



## CAUTION

Please note that the chute deflector on your mower is in an upright position. It is held in that position by a shipping block. This block is used for shipping purposes only. It must be removed and discarded before your mower is put into operation.

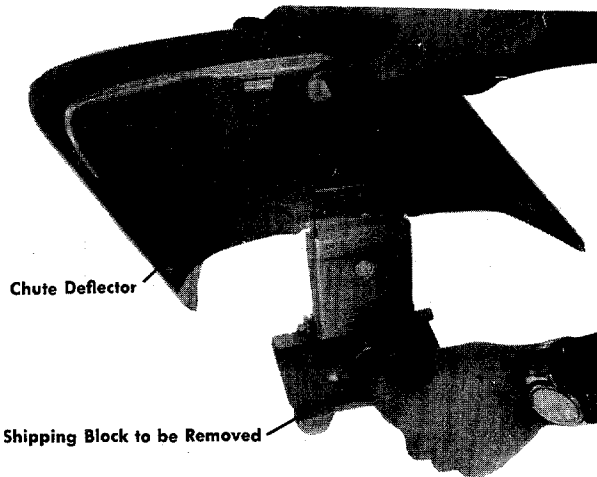

This mower should be broken in following the procedure described in the break-in instructions. The added effort here will double the service life of the unit. Particular attention should be paid to the notes on alignment.

When operating this mower, unnecessary or excessive engaging of the drive pinions with the wheels should be avoided. This is achieved by minimizing the raising and lowering of the handle during the mowing operation. Failure to observe this operating rule can reduce the service life of the front tires and drive pinions substantially. When engaging the self-propelled mechanism, a slight forward push on the mower as the drive pinions and the gear tread tires mesh will add to smoother and quieter operation. In addition to a smoother operation, it will add substantially to the service life of both the tires and the drive pinions.

### HANDLE ASSEMBLY PRECAUTIONS

Although the handle is of simple design, difficulty has been encountered in its assembly. Certain precautions concerning its assembly must be heeded. The handle must be assembled as shown in the diagram on page 4. Trouble arises when certain parts are put together improperly.

### BREAK-IN INSTRUCTIONS

1. Before starting the engine, lubricate all the bronze bearings on the drive shaft. The same oil which is used for the engine may be used for this.

2. Check drive assembly alignment. When the handle is lifted the clutch rod is moved to the self-propelled position. The black nylon drive pinions should mesh simultaneously with the gear tread tires.

## OPERATION

1. Service engine with gas and oil. See Engine Maintenance for complete instructions for care and maintenance of engine. **READ DIRECTIONS CAREFULLY.**
2. Lubricate bronze bearings on drive shaft.
3. Check drive assembly for correct alignment. (See Break-in Instructions.)
4. When ready to start engine, be sure handle is all the way back into free wheeling position. Start engine. After engine starts, move throttle control lever on handle to the desired engine speed.
5. When the handle is moved forward for self-propelled operation, the drive pinions engage with the gear tread tires and forward drive results.
6. Temporary free wheeling is achieved by depressing the handle and raising front wheels slightly off the ground. Self-propelled drive is resumed when handle is raised. Engine is stopped by placing control lever on handle into STOP position.



### IMPORTANT

Always stop engine and disconnect spark plug wire before cleaning, lubricating or doing any kind of work on lawn mower.

## LUBRICATION

**Throttle**—Periodically lubricate throttle control lever and throttle wire assembly with a few drops of light oil SAE No. 10 or 20 for ease of operations.

**Bronze Bearings**—Periodically lubricate all bronze bearings with a few drops of light oil SAE No. 10 or 20 to minimize friction.

**Protective Shield**—The pivot points on the protective shield should be lubricated periodically with light oil to prevent any rust or binding.

**Chute Deflector**—The torsion spring and pivot point should be lubricated periodically with light oil to prevent any rust or binding. Deflector must work freely.

**Engine**—See Engine Maintenance for lubrication instructions.

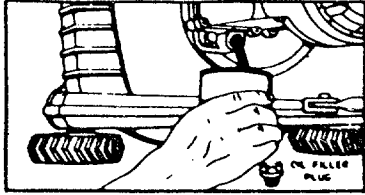

**NOTE: FILL AND DRAIN OIL FROM OIL FILL PLUG.**

## ADJUSTMENTS



**CAUTION**  
Do not at any time make any adjustment to lawn mower without first stopping engine and disconnecting spark plug wire.

### Chain Adjustment—

1. Loosen (do not remove) two hex head cap screws. (See illustration below.)
2. Pull pivot plate forward by hand. Do not force.
3. Tighten cap screws and check chain tension. Repeat adjustment if necessary.

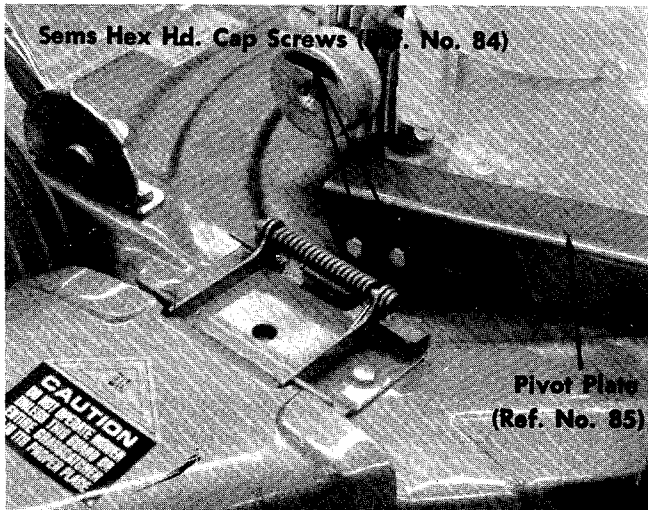

**Cutting Height**—An adjusting plate and thumb lever at each wheel position provides cutting height adjustment. Each adjusting plate has five holes. Height of cut will be changed when the thumb lever is moved from one hole to another. Simply depress thumb lever towards wheel and move wheel and lever assembly to desired position. All wheels must be positioned in relative height of cut position.

**Throttle**—If adjustment becomes necessary, the throttle control wire assembly can be reset as follows:

1. Loosen, but do not remove, screw securing throttle control wire assembly at engine.
2. Move throttle control lever on handle to FAST position.
3. Move lever, to which control wire is fastened at engine, to full open position and retighten screw to secure throttle control wire assembly.

### CLUTCH ROD ADJUSTMENT

1. Remove the cotter pin. See figure A.

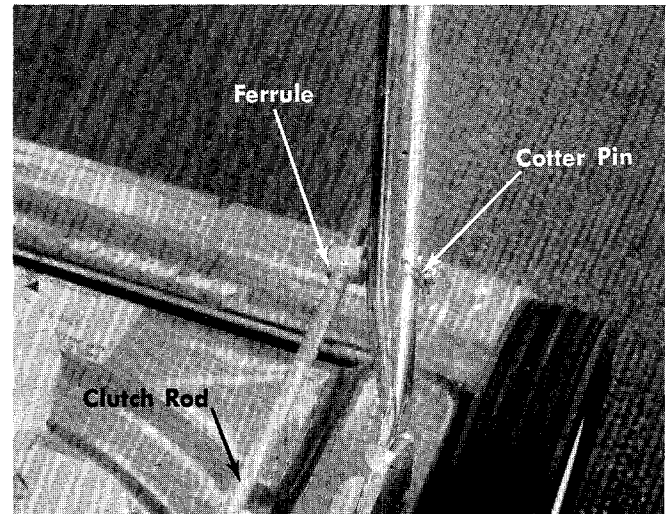

**FIGURE A.**

2. Pull the clutch rod and ferrule out of the lower handle. See figure B.

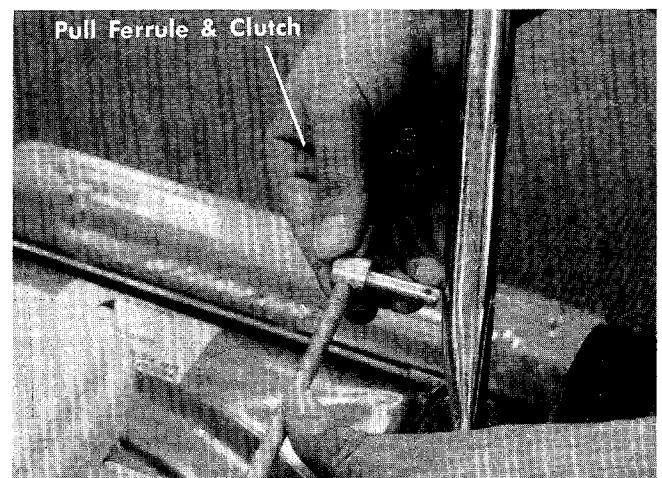

**FIGURE B.**

3. Thread the ferrule on or off the rod one turn and check for alignment.
4. Place ferrule back in position and secure with cotter pin. If the engagement is still not correct, repeat the above steps.

5. The drive pinions should be about 1/8" from the drive wheels. See figure C.

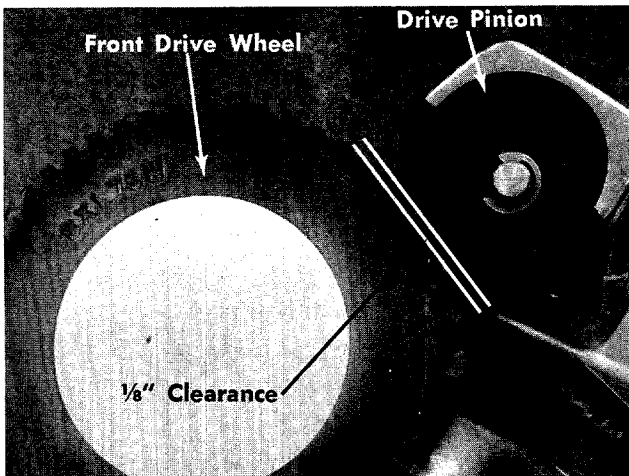

**FIGURE C.**

6. Figures D, E, F and G will give the approximate length of rod that should be showing for each cutting height.

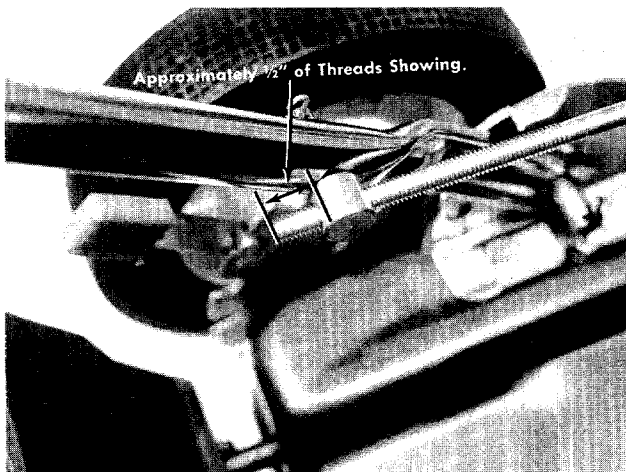

**FIGURE D. CLUTCH ROD SETTING FOR THE FIRST AND SECOND HIGHEST CUTTING HEIGHT.**

Approximately 1/4" of Threads Showing.

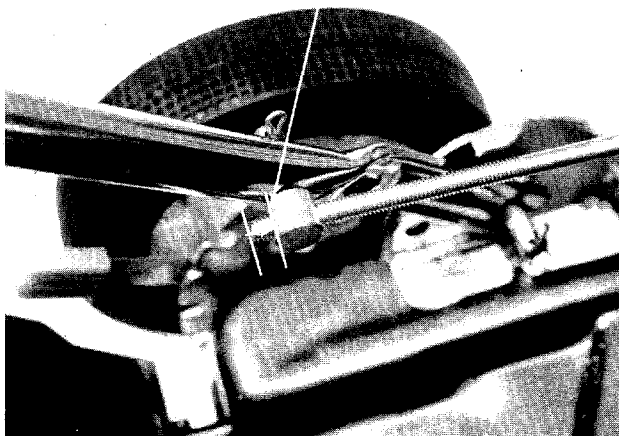

**FIGURE E. CLUTCH ROD SETTING FOR THE MIDDLE CUTTING HEIGHT.**

Approximately One Thread of Ferrule Showing.

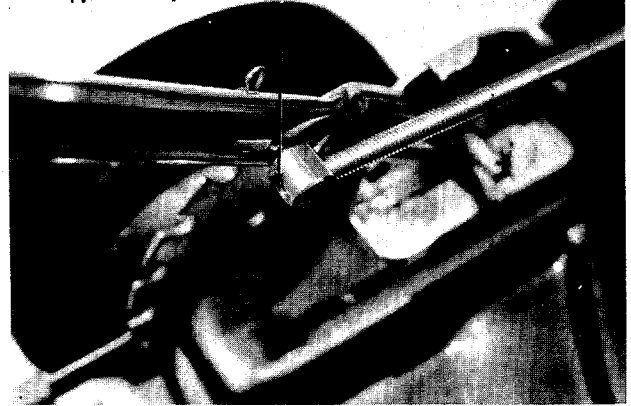

**FIGURE F. CLUTCH ROD SETTING FOR THE SECOND LOWEST CUTTING HEIGHT**

Approximately One Thread Showing on Rod.

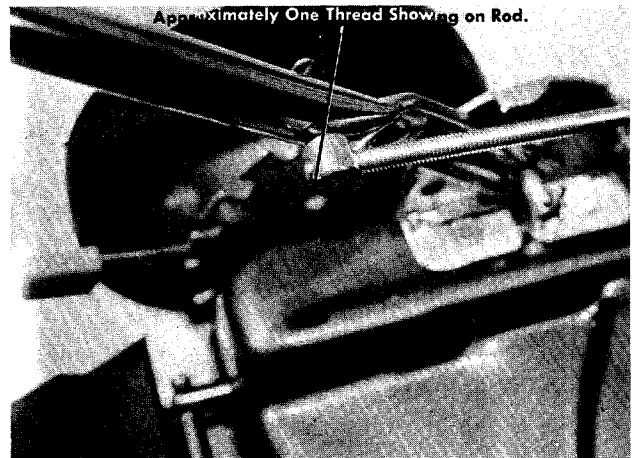

**FIGURE G. CLUTCH ROD SETTING FOR THE LOWEST CUTTING HEIGHT.**

## MAINTENANCE

**Cutting Blade**—The blade may easily be removed for grinding or replacement as follows:

1. Remove bolt and lockwasher holding blade and blade adapter to engine crankshaft.
2. Remove blade and blade adapter from engine crankshaft.
3. Remove two bolts, lockwashers and nuts holding blade to blade adapter (if necessary).

When sharpening blade, follow the original angle of grind as a guide. It is extremely important that each cutting edge receives an equal amount of grinding to prevent an unbalanced blade. An unbalanced blade will cause excessive vibration when rotating at high speeds and may cause damage to the mower.

Upon reassembly, make certain all parts are assembled properly and tightened securely.

To insure safe operation of your unit, **all** nuts and bolts must be checked periodically for correct tightness.

**Deck**—The underside of mower deck should be cleaned after each period of use as grass clippings, leaves, dirt and other matter will accumulate. This accumulation of grass clippings, etc., is undesirable as it will invite corrosion and cause an uneven discharge of grass clippings at the next cutting.

The deck may be cleaned by tilting the mower forward or on its left side and scraping clean with a suitable tool or by washing with a stream of water from a garden hose.



### CAUTION

Do not direct the stream of water at a hot engine as damage to the engine may result.

## STORAGE

The following steps should be taken to prepare lawn mower for storage.

1. Clean and lubricate mower thoroughly as described in the preceding instructions.
2. Refer to engine manual for correct engine storage instructions.
3. Coat mower's cutting blade with chassis grease to prevent rusting.
4. Place blocks under deck to raise tires clear of floor.
5. Store mower in a dry, clean area.

## USING YOUR ROTARY MOWER

For best results do not cut wet grass because it tends to stick to the underside of the mower thus preventing proper discharge of grass clippings. If wet grass must be cut, reduce engine speed and walking speed to help distribute the clippings more effectively.

New grass should be treated as wet grass, otherwise a normal walking speed is about the right pace for efficient mowing.

The best mowing pattern is one that allows the clippings to discharge towards the uncut part of the lawn. This permits recutting of the clippings to further pulverize them. When cutting high weeds, discharge towards cut portion then recut at right angles to first direction.

Lawn should be cut in the fall as long as there is growth.

## HANDLE STORAGE

This model is so equipped to provide easy fold away handle storage.

1. Remove hair pin cotter.
2. Pull ferrule out of the handle.
3. Replace hair pin cotter.
4. Loosen the two plastic knobs on each side, center of handle.
5. Pull inward on the bottom of each side of the lower handle and push forward.
6. Fold the upper handle back and down as shown.

### To Take the Handle out of Storage Position.

1. Lift the upper handle up and towards the rear as shown.
2. Pull the handle back until it **locks** into the operator's position.
3. Tighten the two plastic knobs securely.
4. Reassemble the clutch rod.

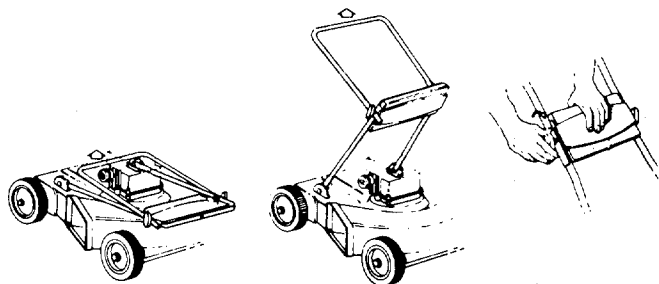



 **NOTE**

The manufacturer DOES NOT recommend the use of any accessory on this rotary mower other than those manufactured by the mower manufacturer.

GRASS CATCHER Model No. 199-003A is available as optional equipment for the mowers shown in this manual.



**WARNING:**

1. The mower should not be operated without the entire grass catcher or chute deflector in place.
2. The mower should not be operated without the protective shield on the rear of the deck in place.



**NOTE:**

Under normal usage bag material is subject to wear and should be checked periodically. Be sure any replacement bag complies with the mower manufacturer's recommendations.

For replacement bags, use only factory authorized replacement bag No. 764-0119.

 **IMPORTANT**

After striking a foreign object, stop the engine, remove wire from spark plug. Thoroughly inspect the mower for any damage, and repair the damage before restarting and operating the mower.

# 129-270A

IF YOU WRITE TO US ABOUT THIS ARTICLE  
OR IF YOU ORDER REPLACEMENT PARTS AL-  
WAYS MENTION THIS MODEL & SERIAL NO  
MODEL

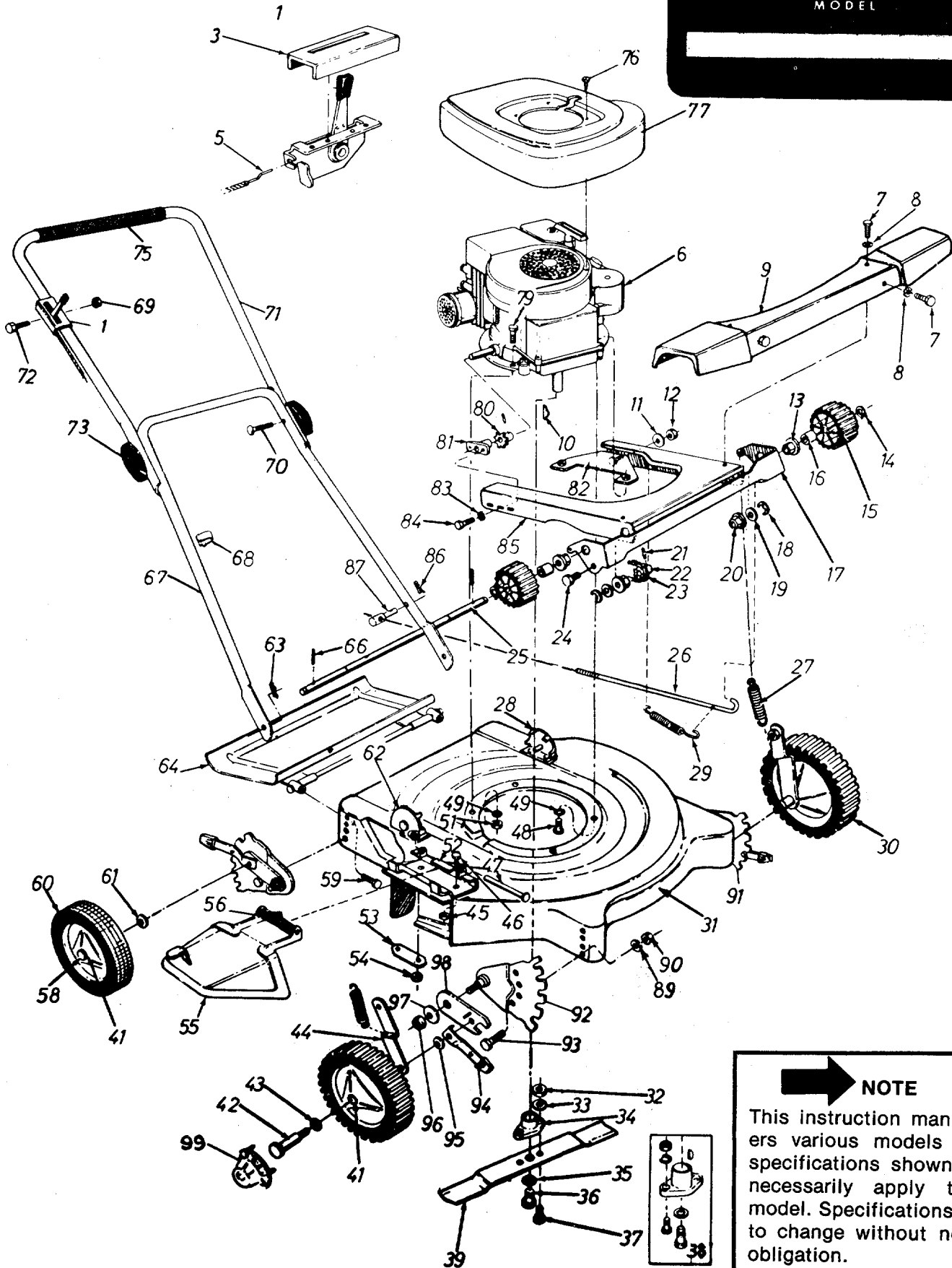

## NOTE

This instruction manual covers various models and all specifications shown do not necessarily apply to your model. Specifications subject to change without notice or obligation.

PARTS LIST FOR MODEL 129-270A

REF. NO.	PART NO.	COLOR CODE	DESCRIPTION	NEW PART	REF. NO.	PART NO.	COLOR CODE	DESCRIPTION	NEW PART
1	746-0249		Throttle Control Ass'y Comp.		49	736-0119		Spring L-Wash. 5/16" Scr.*	
3	731-0344		Plastic Label		51	712-0123		Hex Nut 5/16-24 Thd.*	
5	746-0174		Conduit and Wire		52	11130	-462	Adapter Plate	
6	—		Engine		53	08405		Reinforcement Plate	
7	710-0289		Hex Hd. Cap Scr. 1/4-20 x .50" Lg.*		54	712-0107		Hex Center L-Nut 1/4-20 Thd.	
8	736-0222		External L-Wash. 1/4" Scr.*		55	11679	-462	Chute Deflector Ass'y Comp.	
9	10913	-462	Drive Cover		56	732-0253		Torsion Spring	
10	714-0365		#6 Hi-Pro Key 5/32 x 5/8" Dia.		58	738-0133		Shoulder Scr. .498" Dia. x 1.450 (Axle Bolt—Rear)	
11	736-0300		Flat Washer .385" I.D. x .87" O.D. x .06		59	710-0567		Hex Hd. Cap Scr. 1/4-28 x .62" Lg.	
12	712-0116		Elastic Locknut 3/8-24 Thd.		60	734-0843		Wheel Ass'y. Comp.—Rear	N
13	748-0227		Hex Flange Bearing .630 I.D. Bronze		61	736-0105		Belleville Washer	
14	716-0106		"E"-Ring for 5/8" Shaft		62	11802		Handle Mtg. Brkt. Ass'y.—R.H.	
15	10914		Drive Pinion		63	714-0104		Hair Pin Cotter	
16	02265		Sleeve .44" Dia. x 16 ga.		64	11197	-462	Protective Shield Ass'y—Comp.	
17	10372	-462	Drive Support		66	715-0246		Spring Pin Spirol 3/16 x 1.25" Lg.	
18	716-0106		"E"-Ring for 5/8" Shaft		67	11616		Lower Handle	
19	736-0116		Flat Washer .635" I.D. x .93" O.D. x .060		68	726-0178		Cable Tie	
20	748-0227		Hex Flange Bearing .630" I.D. Bronze		69	712-0107		Hex Center L-Nut 1/4-20 Thd.	
21	715-0247		Roll Pin 3/16" Dia. x 1.00" Lg.*		70	710-0405		Curved Hd. Bolt 5/16-18 x 1 1/4"	
22	10378		Sprocket Ass'y. 8 Tooth		71	11204		Upper Handle	
23	713-0135		Chain with Master Link #48 x 26" Lg.		72	710-0606		Hex Hd. Cap Scr. 1/4-20 x 1.50" Lg.*	
24	738-0147		Shld. Scr. .500" Dia. x .170		73	09966		Hand Knob	
25	711-0435		Drive Shaft		75	718-0145		Grip	
26	12613		Clutch Rod		76	710-0227		Hex Wash. Hd. AB-Tapp Scr. #8 x .38" Lg.	
27	732-0209		Extension Spring		77	731-0314		Shroud	
28	11801		Handle Mtg. Brkt. Ass'y.—L.H.		79	710-0158		Hex Hd. Cap Scr. 5/16-24 x 1.25" Lg.*	
29	732-0433		Tension Spring		80	10377		Sprocket Ass'y. 8 Tooth	
30	734-0880		Front Wheel Ass'y. Comp.	N	81	748-0183		Bearing Support	
31	12421	-462	Deck Ass'y.		82	10381		Engine Bracket Ass'y.	
32	712-0123		Hex Nut 5/16-24 Thd.*		83	736-0222		Ext. Lockwasher 1/4" Scr.*	
33	736-0119		Spring L-Wash. 5/16" Scr.*		84	710-0230		Hex Hd. Cap Scr. 1/4-28 x .50" Lg.*	
34	10769		Blade Adapter Kit		85	11240		Pivot Plate Ass'y.	
35	736-0217		Spring L-Wash. 3/8" Scr. Heavy Duty		86	714-0104		Internal Cotter Pin 1/2" Dia.	
36	710-0459		Hex Hd. Cap Scr. 3/8-24 x 1.50" Lg. H.T.		87	711-0570		Engagement Ferrule	
37	710-0117		Hex Hd. Cap Scr. 5/16-24 x 1.00" Lg. H.T.		89	736-0169		Spring L-Wash. 3/8" Scr.*	
38	10769		Blade Adapter Kit		90	712-0798		Hex Nut 3/8-16 Thd.*	
39	742-0125		22 inch Blade		91	12321		Index Plate Ass'y.—L.H.	
41	741-0262		Fortiflex Bearing (2 per wheel)	N	92	12322		Index Plate Ass'y.—R.H.	
42	738-0144		Shoulder Scr. .498" Dia. x 1.640 (Axle Bolt Front Only)		93	710-0209		Sems Hex Scr. 3/8-16 x .62" Lg.*	
43	736-0160		Flat Washer .385" I.D. x .87 O.D. x .06		94	10530		Spring Lever Ass'y with Knob	
44	10918		Link Assembly		95	736-0105		Belleville Washer	
45	712-0107		Hex Center L-Nut 1/4-20 Thd.		96	712-0116		Elastic Locknut 3/8-24 Thd.	
46	710-0289		Hex Hd. Cap Scr. 1/4-20 x .50" Lg.		97	736-0219		Belleville Washer	
47	711-0555		Pivot Pin		98	10619		Pivot Bar	
48	710-0442		Hex Hd. Cap Scr. 5/16-18 x 1.50" Lg.*		99	731-0124		Hub Caps	
					100	751-0109		Dip Stick (Not Shown)	

(462-Red Flake)

When ordering parts if color or finish is important, use the appropriate color code shown above. (e.g. Red Flake Finish—10913 (462).)

NOTE: The engine is not under warranty by the mower manufacturer . . . If repairs or service is needed on the engine, please contact your nearest authorized engine service outlet. Check the "Yellow Pages" of your telephone book under "Engines—Gasoline."



# PARTS INFORMATION

## POWER EQUIPMENT PARTS AND SERVICE

Parts and service for all MTD manufactured power equipment are available through the authorized service firms listed below. All orders should specify the model number of your unit, parts number, description of parts and the quantity of each part required.

<b>ALABAMA</b>	<b>BIRMINGHAM</b>	
Auto Electric & Carburetor Co. . . . .	2625 4th Ave. S. . . . .	35233
<b>ARKANSAS</b>	<b>NORTH LITTLE ROCK</b>	
Sutton's Lawn Mower Shop . . . . .	Rt. 4 Box 368 . . . . .	72117
	<b>FORT SMITH</b>	
Mity Mite Motors, Inc. . . . .	2515 Towson Ave. . . . .	72901
<b>CALIFORNIA</b>	<b>PORTERVILLE</b>	
Billious . . . . .	75 North D Street . . . . .	93257
	<b>SAN BERNARDINO</b>	
Lawn Mower Supply Co. . . . .	25608 E. Baseline . . . . .	92410
	<b>SAN FRANCISCO</b>	
J.W. Jewett Co. . . . .	981 Folsom St. . . . .	94107
	<b>SACRAMENTO</b>	
Luttig & Severson . . . . .	2030 28th St. . . . .	95818
<b>COLORADO</b>	<b>DENVER</b>	
South Denver Lawn Equip. . . . .	527 West Evans . . . . .	80223
<b>FLORIDA</b>	<b>JACKSONVILLE</b>	
Radco Distributors . . . . .	2403 Market St. . . . .	32206
	<b>CORAL GABLES</b>	
Moz-All of Florida, Inc. . . . .	365 Greco Ave. . . . .	33146
<b>GEORGIA</b>	<b>EAST POINT</b>	
East Point Cycle & Key . . . . .	2834 Church St. . . . .	30344
<b>ILLINOIS</b>	<b>LYONS</b>	
Keen Edge Co. . . . .	8615 Ogden Ave. . . . .	60534
<b>INDIANA</b>	<b>ELKHART</b>	
Parts & Sales Inc. . . . .	2101 Industrial Pkwy. . . . .	46514
<b>IOWA</b>	<b>DUBUQUE</b>	
Power Lawn & Garden Equip. . . . .	2551 J.F. Kennedy . . . . .	52001
<b>LOUISIANA</b>	<b>NEW ORLEANS</b>	
Suhren Engine Co. . . . .	8330 Earhart Blvd. . . . .	70118
<b>MARYLAND</b>	<b>TAKOMA PARK</b>	
Center Supply Co. . . . .	6867 New Hampshire Ave. . . . .	20012
<b>MASSACHUSETTS</b>	<b>SPRINGFIELD</b>	
Morton B. Collins Co. . . . .	300 Birnie Ave. . . . .	01107
<b>MICHIGAN</b>	<b>MOUNT CLEMENS</b>	
Power Equipment Dist. . . . .	36463 South Gratiot . . . . .	48043
	<b>LANSING</b>	
Lorenz Service Co. . . . .	2500 S. Pennsylvania . . . . .	48900
<b>MINNESOTA</b>	<b>MINNETONKA</b>	
Hance Distributing Inc. . . . .	11212 Wayzata Blvd. . . . .	55343
	<b>ST. PAUL</b>	
Power Tools Inc. . . . .	3771 Sibley Memorial Hwy. . . . .	55122
<b>MISSISSIPPI</b>	<b>BILOXI</b>	
Biloxi Sales & Service, Inc. . . . .	506 Caillavet St. . . . .	39533
<b>MISSOURI</b>	<b>KANSAS CITY</b>	
Automotive Equip. Service . . . . .	3117 Holmes St. . . . .	64109
	<b>ST. JOSEPH</b>	
Ross-Frazier Supply Co. . . . .	8th and Monteray . . . . .	64503
	<b>ST. LOUIS</b>	
Henzler, Inc. . . . .	2015 Lemay Ferry Rd. . . . .	63125
<b>NEW JERSEY</b>	<b>BELLMAWR</b>	
Lawnmower Parts Inc. . . . .	717 Creek Rd., P.O. Box 7.08030	
	<b>RUTHERFORD</b>	
Feld Distributor . . . . .	28 Glen Rd. . . . .	07070
<b>NEW YORK</b>	<b>CARTHAGE</b>	
Gamble Dist., Inc. . . . .	West End Ave. . . . .	13619

## BRIGGS AND STRATTON, TECUMSEH AND PEERLESS PARTS AND SERVICE

Briggs & Stratton, Tecumseh and Peerless parts and service should be handled by your nearest authorized engine service firm. Check the yellow pages of your telephone directory under the listing **Engines—Gasoline**, Briggs & Stratton or Tecumseh Lauson.

	<b>SYRACUSE</b>	
GTP Leisure Products Inc. . . . .	420 Marcellus St. . . . .	13204
<b>NORTH CAROLINA</b>	<b>GREENSBORO</b>	
Dixie Sales Company . . . . .	327 Battleground Ave. . . . .	27402
	<b>GOLDSBORO</b>	
Smith Hardware Co. . . . .	515 N. George St. . . . .	27530
<b>OHIO</b>	<b>WADSWORTH</b>	
National Central . . . . .	687 Seville Rd. . . . .	44281
	<b>CLEVELAND</b>	
Bleckrie, Inc. . . . .	7900 Lorain Ave. . . . .	44102
	<b>CARROLL</b>	
Stebe's Mid-State Mower Supply, Box 366-71 High St. . . . .		43112
	<b>YOUNGSTOWN</b>	
Burton Supply Co. . . . .	1301 Logan Ave. Box 929 . . . . .	44501
<b>OKLAHOMA</b>	<b>MUSKOGEE</b>	
Victory Motors, Inc. . . . .	605 S. Cherokee . . . . .	74401
	<b>OKLAHOMA CITY</b>	
Forest Sales Inc. . . . .	1039 NW 63rd St. . . . .	73116
	<b>ADA</b>	
Ada Auto Supply . . . . .	301 E. 12th St. . . . .	74820
<b>OREGON</b>	<b>PORTLAND</b>	
Kenton Supply Co. . . . .	8216 N. Denver Ave. . . . .	97217
<b>PENNSYLVANIA</b>	<b>CHESTER</b>	
Stull Equipment Corp. . . . .	742 W. Front St. . . . .	19013
	<b>HARRISBURG</b>	
EECO Inc. . . . .	4021 N. 6th St. . . . .	17110
	<b>PHILADELPHIA</b>	
Thompson Rubber Co. . . . .	5222-24 N Fifth St. . . . .	19120
	<b>PITTSBURGH</b>	
Bluemont Co. . . . .	11125 Frankstown Rd. . . . .	15235
<b>TENNESSEE</b>	<b>KNOXVILLE</b>	
Master Repair Service . . . . .	2423 Broadway, N.E. . . . .	37917
	<b>MEMPHIS</b>	
Memphis Cycle & Supply Co. . . . .	421 Monroe Ave. . . . .	38103
American Sales & Service, Inc. . . . .	1922 Lynnbrook . . . . .	38116
<b>TEXAS</b>	<b>DALLAS</b>	
Marr Brothers, Inc. . . . .	423 E. Jefferson . . . . .	75203
	<b>HOUSTON</b>	
Bullard Supply Co. . . . .	2409 Commerce St. . . . .	77003
	<b>SAN ANTONIO</b>	
Catto & Putty, Inc. . . . .	P.O. Box 2408 . . . . .	78206
	<b>FORT WORTH</b>	
Woodson Sales Corp. . . . .	1702 N. Sylvania . . . . .	76111
<b>UTAH</b>	<b>SALT LAKE CITY</b>	
A-1 Engine & Mower Co. . . . .	437 E. 9th St. . . . .	84111
<b>VERMONT</b>	<b>BURLINGTON</b>	
Vermont Hdwe. Co. Inc. . . . .	180 Flynn Ave. . . . .	05401
<b>VIRGINIA</b>	<b>RICHMOND</b>	
RBI Corp. . . . .	963 Myers St. . . . .	23260
<b>WASHINGTON</b>	<b>SEATTLE</b>	
Bailey's Inc. . . . .	1414 14th Ave. . . . .	98122
<b>WEST VIRGINIA</b>	<b>CHARLESTON</b>	
Young's, Inc. . . . .	233 Virginia St., E. . . . .	25301
<b>WISCONSIN</b>	<b>APPLETON</b>	
Automotive Supply Co. . . . .	123 S. Linwood Ave. . . . .	54911

## WARRANTY PARTS AND SERVICE POLICY

The purpose of warranty is to protect the customer from defects in workmanship and materials, defects which are NOT detected at the time of manufacture. It does not provide for the unlimited and unrestricted replacement of parts. Use and maintenance are the responsibility of the customer. The manufacturer cannot assume responsibility for conditions which it has no control. Simply put, if it's the manufacturer's fault, it's the manufacturer's responsibility; if it's the customer's fault, it's the customer's responsibility.

### CLAIMS AGAINST THE MANUFACTURER'S WARRANTY INCLUDES

1. Replacement of Missing Parts on new equipment.
2. Replacement of Defective Parts within the warranty period.
3. Repair of Defects within the warranty period.

All claims MUST be substantiated with the following information:

1. Model Number of unit involved.
2. Date unit was purchased or first put into service.
3. Date of failure.
4. Nature of failure.